



Cat. No. 43-687
OWNER'S MANUAL

Please read before using this equipment.

ET-687

**Two-Line 900MHz Digital Spread Spectrum
Cordless Telephone**

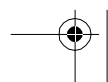
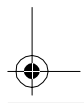
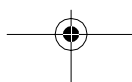
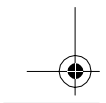

FEATURES

Your RadioShack ET-687 Two-Line 900MHz Digital Spread Spectrum Cordless Telephone lets you place and receive calls on two separate telephone lines. It is designed to exacting standards that ensure reliability, long life, and outstanding performance.

Its features include:

Spread Spectrum Technology — spreads the signal across several frequencies, providing additional security for your phone conversations.

900 MHz Operation — provides longer range and less interference than many other cordless phones.

Ample Talk and Standby Time — the supplied battery pack (when fully charged) provides 4 hours of continuous talk time or 7 days of standby time.

20-Number Memory Dialing — lets you store up to 20 numbers in memory (ten each in the handset and base) for easy dialing.

Paging/Two-Way Intercom — lets you send a signal from the base to the handset, or from the handset to the base, to page someone or locate the handset when it is away from the base. If someone answers, you can use the ET-687 as an intercom.

Dual Keypads — a full set of keys on both the ET-687's handset and base lets you use either keypad to make and answer calls or use the phone's features.

Handset Volume Control — lets you adjust the volume of the sound you hear through the handset.

Two-Line Telephone System — lets you easily handle two telephone lines at the same time. You can also use both lines at once to make three- or four-way conference calls.

Line Status Indicators — show if a line is available, in use, or on hold.

Speakerphone — lets you make or answer calls without using the handset.

Headset Jack — lets you talk with hands-free convenience using an optional headset.

20 Channels — automatically selects a clear channel when you make or answer a call.

Security Access-Protection Code — automatically prevents other cordless phone users from using your phone line while the handset is off the base.

Adjustable Ringers — give you two volume settings for the handset and base ringers.

Any Key Answer — you can answer a call by pressing any number key on the handset or base.

COM-LOK[®] — ensures that other cordless phone users cannot use your phone line when the handset is on the base.

© 1998 Tandy Corporation.
All Rights Reserved.

COM-LOK and RadioShack are registered trademarks used by Tandy Corporation.

Redial — lets you quickly redial the last number dialed.

Flash — sends an electronic switchhook signal for use with special phone services, such as Call Waiting.

Tone/Pulse Dialing — lets you use either type of service, and you can easily switch from pulse to tone dialing for special services such as bank-by-phone.

Hearing-Aid Compatibility — lets you use your phone with hearing aids that have a T (telephone) switch.

This telephone has been tested and found to comply with all applicable standards.



We recommend you record your phone's serial number here. The number is on the bottom of the base.

Serial Number: _____

Important Note: Cordless phones such as your ET-687 require AC power to operate. When the AC power is off, you cannot dial out or receive incoming calls using this phone. To be safe, you should also have a phone that does not need AC power to operate (not a cordless phone) so you can still make and receive calls if there is an AC power failure.

Your telephone operates on standard radio frequencies as allocated by the FCC. Even though the security access-protection code prevents unauthorized use of your phone line, it is possible for other radio units operating on similar frequencies within a certain area to unintentionally intercept your conversations and/or cause interference. This lack of privacy can occur with any cordless phone.

Warning: To reduce the risk of fire or shock hazard, do not expose this product to rain or moisture.

	CAUTION RISK OF ELECTRIC SHOCK. DO NOT OPEN.	
CAUTION: TO REDUCE THE RISK OF ELECTRIC SHOCK, DO NOT REMOVE COVER OR BACK. NO USER-SERVICEABLE PARTS INSIDE. REFER SERVICING TO QUALIFIED PERSONNEL.		



This symbol is intended to alert you to the presence of uninsulated dangerous voltage within the product's enclosure that might be of sufficient magnitude to constitute a risk of electric shock. Do not open the product's case.



This symbol is intended to inform you that important operating and maintenance instructions are included in the literature accompanying this product.

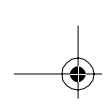

READ THIS BEFORE INSTALLATION

Each device that you connect to the phone line draws power from the phone line. We refer to this power draw as the device's *ringer equivalence number*, or REN. The REN for your ET-687 is on the bottom of the base.

If you are using more than one phone or other device on the line, add up all the RENs. If the total is more than five, your phones might not ring. In rural areas, a total REN of three might impair ringer operation. If ringer operation is impaired, remove a device from the line.

FCC STATEMENT

This telephone complies with Part 68 of *FCC Rules*. Upon request, you must provide the FCC registration number and the REN to your phone company. These numbers are on the bottom of the base.

Note: You must not connect your phone to any of the following:

- coin-operated systems
- party-line systems
- most electronic key phone systems

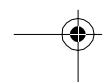
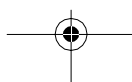
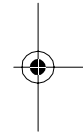
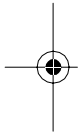

CONTENTS

Installation	6
Mounting the Phone	6
Connecting to the Phone Lines	6
On a Desk Top	7
On a Wall Plate	8
Directly on a Wall	9
Connecting and Charging the Battery Pack	11
Setting the Dialing Mode	13
Setting the Ringers' Volume	13
Operation	14
Using the Handset	14
Making a Call	14
Answering Calls	14
Setting the Handset Volume	14
Using the Speakerphone	15
Making a Call	15
Answering a Call	15
Adjusting the Speakerphone Volume	15
Using Mute	15
Putting a Call on Hold	16
Using Redial	16
Switching Between the Handset and Speakerphone	16
Using Both the Handset and Speakerphone	17
Making a Conference Call	17
Three-Way Conference Call	17
Four-Way Conferencing	17
Using the ET-687 With Extension Phones	18
Using Flash	18
Using Tone Services on a Pulse Line	18
Using Page/Intercom	19
Memory Dialing	20
Storing a Number in Memory	20
Entering a Pause	21
Dialing a Memory Number	21
Chain-Dialing Service Numbers	21
Testing Stored Emergency Numbers	21
Using a Headset	22
Troubleshooting	23
Care and Maintenance	25
Replacing the Battery Pack	26
The FCC Wants You to Know	27
Lightning	27

INSTALLATION

MOUNTING THE PHONE

You can place the ET-687's base on a desk or table, or mount it on a standard wall plate or directly on a wall. Choose a location that is:

- near an AC outlet
- near a modular telephone line jack
- out of the way of normal activities
- away from electrical machinery, electrical appliances, metal walls or filing cabinets, wireless intercoms, alarms, and room monitors
- away from other cordless phones

The base's location affects the handset's range. If you have a choice of several locations, try each to see which provides the best performance.

Caution: The supplied RadioShack adapter was designed specifically for your ET-687. Use only the supplied adapter.

Connecting to the Phone Lines

To take full advantage of the ET-687's capabilities, you must have two phone lines with separate phone numbers. If you have only one line, you can order a second from your phone company.

You can connect the ET-687 to the telephone lines in one of three ways:

- connect two lines through a two-line modular phone jack
- connect two lines through two one-line modular phone jacks
- connect one line through a one-line modular phone jack.

Notes:

- Your phone connects directly to a modular phone line jack. If your phone wiring does not have a modular jack, you can update it using jacks and adapters available at your local RadioShack store, or have the phone company update it for you.
- The line that connects a two-line phone jack to the phone company wiring must be twisted-pair cable. Otherwise, you might hear interference (crosstalk) between the two lines.
- The USOC number of the two-line jack to be installed is RJ14C (RJ14W for a wall plate). The USOC number of a single-line jack is RJ11C.

On a Desk Top

1. Insert the bracket's tabs into the base's upper tab slots as shown, then press down on the bracket's clips and insert them into the clip slots.

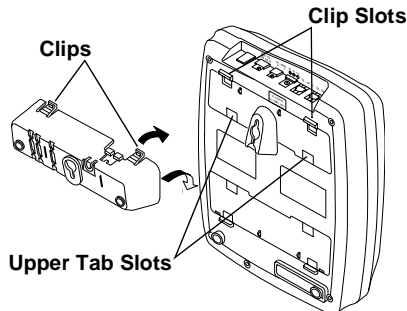

2. To connect the phone to a two-line phone jack, plug one end of the supplied two-line phone cord into the **TEL LINE 1/2** jack on the back of the phone. Route the cord through the strain-relief slot on the bracket.

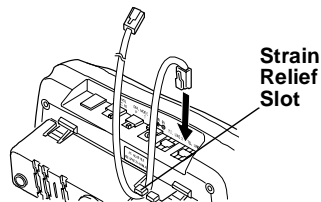

Note: If you connect the phone to a two-line phone jack with a two-line cord, do not connect a cord to the **TEL LINE 2** jack or the phone might not operate properly.

To connect the phone to two one-line phone jacks, plug one end of the supplied two-line cord to the **TEL LINE 1/2** jack, and plug another cord (not supplied) into the **TEL LINE 2** jack. Route both cords through the strain-relief slot on the bracket.

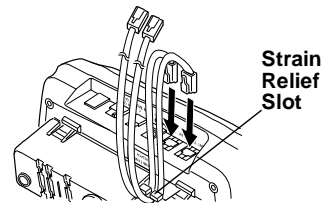

To connect the phone to a single one-line phone jack, plug one end of the supplied cord into the **TEL LINE 1/2** or **TEL LINE 2** jack. Route the cord through the strain-relief slot on the bracket.

3. Insert the supplied AC adapter's barrel plug into the **DC IN 9V** jack on the back of the base.

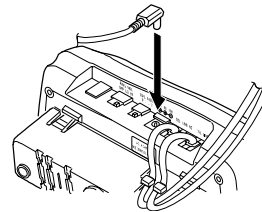

4. Route the adapter's cord through the strain relief slot on the bottom of the bracket.

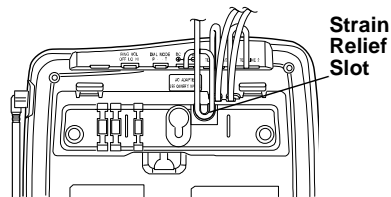

5. Plug the adapter into a standard AC outlet.

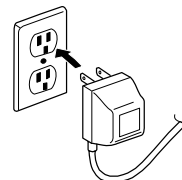

6. Connect the phone cord(s) to the modular phone line jack(s).

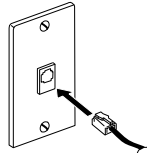

7. Lift the base's antenna to a vertical position.

On a Wall Plate

1. Insert the bracket's tabs into the base's lower tab slots as shown, then press down on the bracket's clips and insert them into the clip slots.

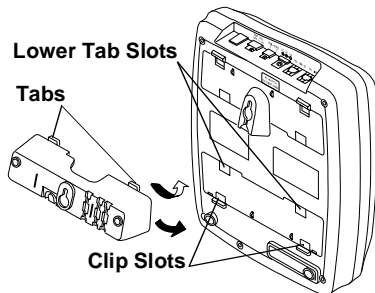

2. To connect the phone to a two-line wall plate jack, plug one end of the supplied short, two-line phone cord into the **TEL LINE 1/2** jack on the back of the phone.

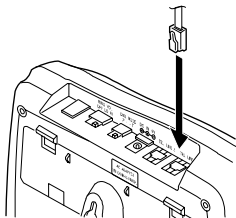

Note: If you connect the phone to a two-line phone jack with a two-line cord, do not connect a cord to the **TEL LINE 2** jack or the phone might not operate properly.

To connect the phone to a one-line wall plate jack and another one-line jack, plug one end of the supplied short, two-line cord to the **TEL LINE 1/2** jack, and plug another cord (not supplied) into the **TEL LINE 2** jack.

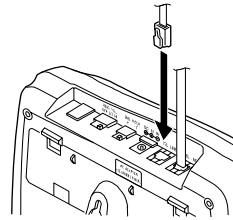

To connect the phone to a single one-line wall plate jack, plug one end of the supplied cord into the **TEL LINE 1/2** or **TEL LINE 2** jack.

3. Insert the supplied AC adapter's barrel plug into the **DC IN 9V** jack.

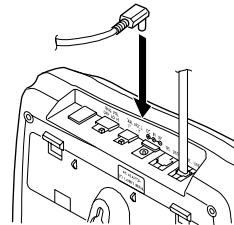

- Route the adapter cord through the narrow groove on the bracket. If you are using two phone cords, route the second cord through one of the wide grooves on the bracket.

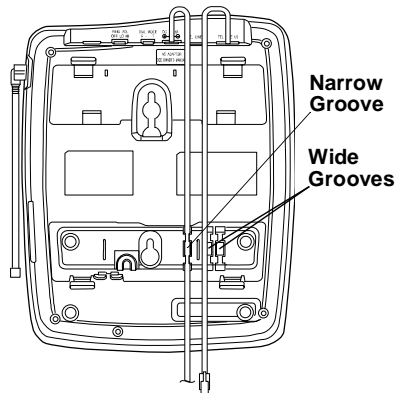

- Plug the other end of the short modular cord into the wall plate jack, then align the bracket's keyhole slots with the wall plate studs and slide the base downward to secure it. If you are using two phone cords, plug the second cord into the second phone jack.

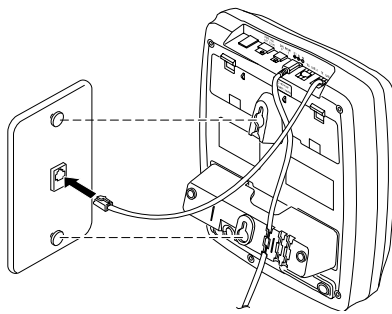

- Plug the adapter into a standard AC outlet.

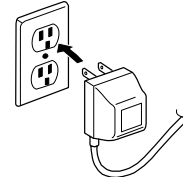

- Press and lift out the handset holder, flip it over as shown, then snap it back into place.

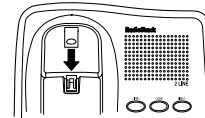
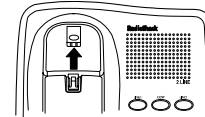

- Lift the base's antenna to a vertical position.

Directly on a Wall

To mount the base directly on the wall, you need two screws (not supplied) with heads that fit into the keyhole slots on the bottom of the base.

- Drill two holes $3\frac{15}{16}$ inches (100 mm) apart. Then thread a screw into each hole, letting the heads extend about $\frac{5}{16}$ inch (8 mm) from the wall.

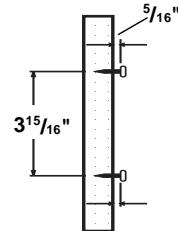

2. Insert the bracket's tabs into the base's lower tab slots as shown, then press down on the bracket's clips and insert them into the clip slots.

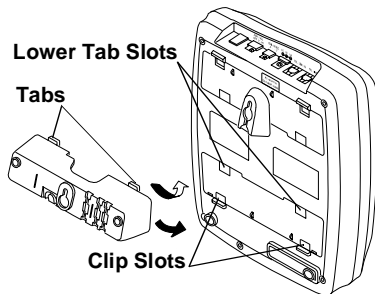

3. To connect the phone to a two-line phone jack, plug one end of the supplied two-line phone cord into the **TEL LINE 1/2** jack on the back of the phone.

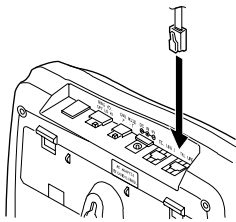

Note: If you connect the phone to a two-line phone jack with a two-line cord, do not connect a cord to the **TEL LINE 2** jack or the phone might not operate properly.

To connect the phone to two one-line phone jacks, plug one end of the supplied two-line cord to the **TEL LINE 1/2** jack, and plug another cord (not supplied) into the **TEL LINE 2** jack.

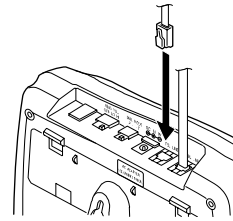

To connect the phone to a single one-line phone jack, plug one end of the supplied cord into the **TEL LINE 1/2** or **TEL LINE 2** jack.

4. Insert the supplied AC adapter's barrel plug into the **DC IN 9V** jack.

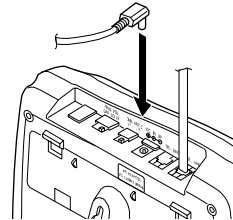

5. Route the modular and adapter's cords through the grooves on the bracket as shown. If you are using two phone cords, route the second cord through one of the wide grooves on the bracket.

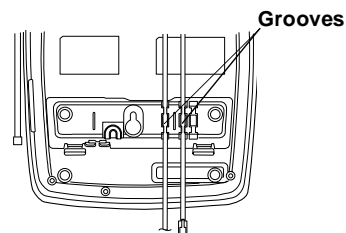

6. Align the bracket's keyhole slots with the mounting screws and slide the base downward to secure it.

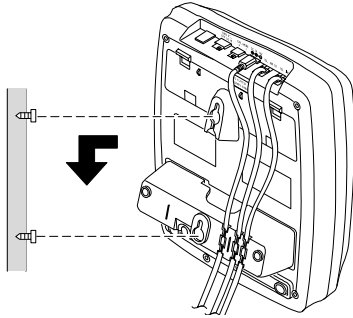

7. Connect the phone cord(s) to the modular phone line jack(s).

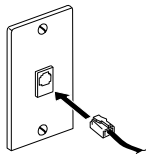

8. Plug the adapter into a standard AC outlet.

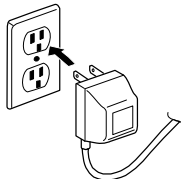

9. Press and lift out the handset holder, flip it over as shown, then snap it back into place.

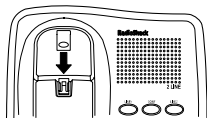
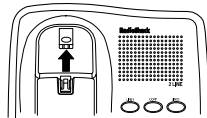

10. Lift the base's antenna to a vertical position.

CONNECTING AND CHARGING THE BATTERY PACK

The ET-687 comes with a rechargeable nickel-cadmium battery pack in the handset but not connected. Before using the phone, you must connect the battery pack, then charge it for about 24 hours.

1. Press down and slide off the battery pack compartment cover as shown.

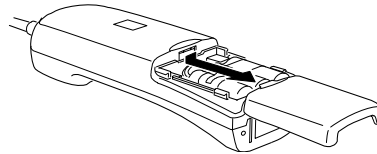

2. Unfasten the plastic retainer strap and lift the battery pack out of the compartment.

3. Plug the battery pack's connector into the socket in the compartment (the connector fits only one way), then replace the battery pack and fasten the retainer strap.

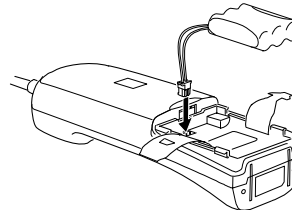

4. Replace the cover.

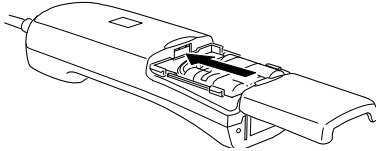

To charge the battery pack, place the handset on the base either faceup or facedown. The CHARGE indicator on the base lights.

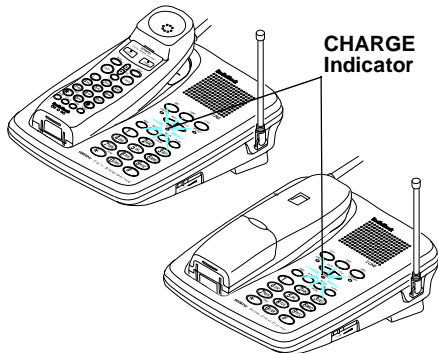

Recharge the battery pack when the handset beeps every 3 seconds or its line indicators flash every 3 seconds.

Important: Be sure the battery pack is properly connected before you try to charge it. The CHARGE indicator lights when the handset is on the base, even if the battery pack is not connected.

Notes:

- When you first use the phone after charging or recharging the battery pack, it might not work and you might hear an error tone when you press **LINE 1** or **LINE 2**. If this happens, return the handset to the base for about 5 seconds. This resets the security access-protection code.

- If the battery pack becomes weak during a call, the handset beeps every 3 seconds. If this happens, you must recharge the battery pack before you can make another call.
- Using a pencil eraser, clean the charging contacts on the handset and the base about once a month.

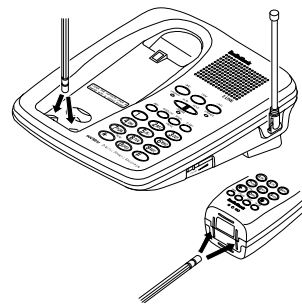

- If the battery pack becomes completely discharged or the base loses power while the handset is away, the security access-protection code needs to be reset. To reset the security code, return the handset to the base. If it was the handset that lost power, leave the handset on the base to charge the battery pack.
- About once a month, fully discharge the battery pack by keeping the handset off the base until the low battery indications (flashing line indicators and beeping) appear. Otherwise, the battery pack loses its ability to fully recharge.
- The supplied battery pack should last about one year. When it loses its ability to fully recharge, order a replacement battery pack from your local RadioShack store (see "Replacing the Battery Pack" on Page 26).

SETTING THE DIALING MODE

Set **DIAL MODE** on the back of the base for the type of service you have (tone or pulse). If you are not sure which type you have, once the battery pack is fully charged, do this test.

1. Set **DIAL MODE** to **T** (tone).

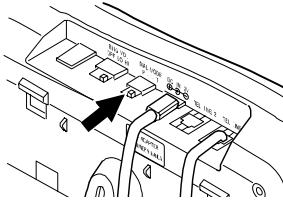

2. Press **LINE 1** on the base. The line 1 indicator lights.
3. Press any number other than **0**.

Note: If your phone system requires that you dial an access code (9, for example) before you dial an outside number, do not press the access code number either.

If the dial tone stops, that line has tone service.

If the dial tone continues, that line has pulse service.

4. Press **LINE 1** to release the line, then repeat the test for Line 2.

If you have tone service on both lines, leave **DIAL MODE** set to **T** (tone).

If you have pulse service on either line, set **DIAL MODE** to **P** (pulse).

SETTING THE RINGERS' VOLUME

At any time except during a call, press **t** or **s** to set the handset's ringer volume. The phone rings at the selected volume.

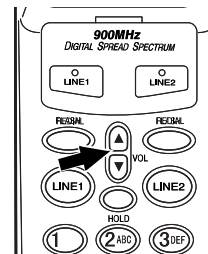

To set the base's ringer volume, set **RING VOL** on the back of the base to **OFF**, **LO**, or **HI**.

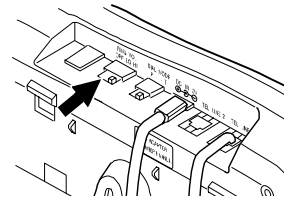

OPERATION

USING THE HANDSET

Making a Call

To make a call, lift the handset, press **LINE 1** (or **LINE 2**), then dial the number. When you press a line button on the handset, that line's indicator on the handset lights. The same line's indicator on the base flashes to show that someone is using that line at the handset.

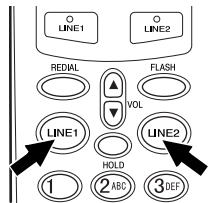

Note: If a line indicator on the handset is flashing, someone is using that line at the base. Press the other line button.

To end a call, press **LINE 1** (or **LINE 2**), or return the handset to the base.

Answering Calls

When a call comes in, the line indicator for that line flashes at the handset and base.

Note: To help you tell which line is ringing, each line has a distinctive ring tone.

To answer a call if the handset is on the base, simply lift the handset. The indicator for the line you are using lights at the handset and flashes at the base.

To answer a call if the handset is away from the base, press the line button for the line that is ringing, or simply press any number button. The indicator for the line you are using lights at the handset and flashes at the base.

If you receive a call on one line while you are using the handset to talk on the other, you hear three ring tones through the handset. Press the line button for the incoming call's line. The current call is automatically put on hold.

If both lines have an incoming call, pressing a number key answers the line that began ringing first.

Setting the Handset Volume

To increase the handset's volume during a call, press **VOL s**. Press **VOL t** to return to the normal setting. When you hang up or transfer a call to the base, the volume returns to the normal setting.

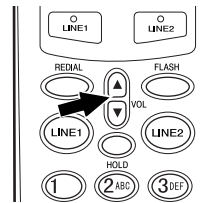

Note: When you press **s** while the volume is high or **t** while the volume is normal, an error tone (five quick beeps) sounds.

USING THE SPEAKERPHONE

Making a Call

To make a call, press **LINE 1** (or **LINE 2**), listen for a dial tone, then dial the number. When you press a line button on the base, that line's indicator on the base lights. The same line's indicator on the handset flashes to show that someone is using that line at the handset.

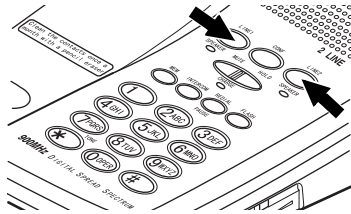

Note: If a line indicator on the base is flashing, someone is using that line at the handset. Press the other line button.

To end a call, press **LINE 1** (or **LINE 2**).

Answering a Call

When a call comes in, the line indicator for that line flashes at the handset and base.

To answer a call, press the line button for the line that is ringing, or simply press any number key. The indicator for that line lights at the base and flashes at the handset.

If you receive a call on one line while you are using the speakerphone to talk on the other, the new call's line indicator

flashes. Press the line button for the incoming call. The current call is automatically put on hold.

If both lines have an incoming call, pressing a number key answers the line that began ringing first.

Adjusting the Speakerphone Volume

To set the speakerphone's volume, slide **VOLUME** on the right side of the base.

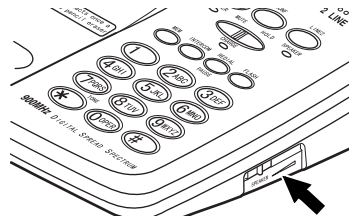

Using Mute

While talking on the speakerphone, you can temporarily turn off the ET-687's microphone by pressing **MUTE** so the other party cannot hear you. The line indicator flashes red when a line is muted.

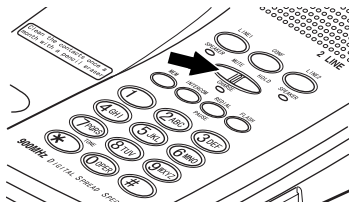

Press **MUTE** again to resume your conversation.

Note: **MUTE** does not work during an intercom call.

PUTTING A CALL ON HOLD

Press **HOLD** on the handset or base to put a call on hold. The indicator for that line flashes on the handset and lights red at the base. While a call is on hold, you can place the handset on the base or use the other line without disconnecting the current call.

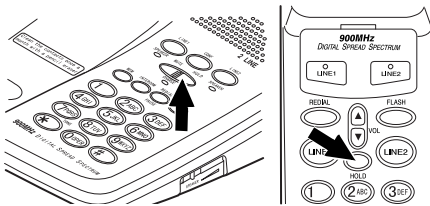

To release a line from hold, press that line's button on the handset or base, or pick up an extension phone. If the handset is on the base, you can release a call from hold simply by lifting the handset.

Note: If you put both lines on hold, lifting the handset might not release the call. If this happens, press the line button to release that line.

USING REDIAL

You can quickly dial the last number dialed on either Line 1 or Line 2. When you hear a dial tone, simply press **REDIAL** on the handset or base.

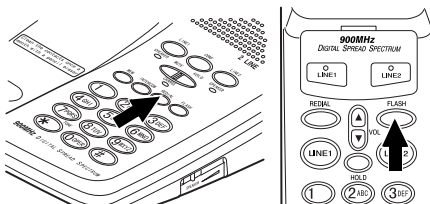

Notes:

- Each keypad has a separate redial memory. You cannot redial a number you dialed on one keypad using **REDIAL** on the other.
- The redial memory is common to both lines. You can redial the number you originally dialed on Line 1 using Line 2.
- The redial memory holds up to 32 digits, so you can redial long distance as well as local numbers.
- When you press **FLASH** and press any number key, the redial memory stores the number entered after **FLASH**, deleting any previous entry (see "Using Flash" on Page 18).

SWITCHING BETWEEN THE HANDSET AND SPEAKERPHONE

To switch to the speakerphone when you are using the handset, press **HOLD** on the handset, then press that line's button (**LINE 1** or **LINE 2**) on the base.

To switch to the handset when you are using the speakerphone and the handset is on the base, just lift the handset. If the handset is away from the base, press **HOLD** on the base, then press that line's button (**LINE 1** or **LINE 2**) on the handset.

USING BOTH THE HANDSET AND SPEAKERPHONE

To use the handset to join a call at the base, or to use the base to join a conversation at the handset, press the line button for the line that is in use. You hear a warning tone (three long beeps). Before the warning tone ends, press the line button again.

During the call, you can hang up at either the base or the handset without disconnecting the call. To end the call, you must hang up both the base and handset.

3. Press **CONF**. Both line indicators light steadily. You can now talk with both parties, and they can talk with each other.

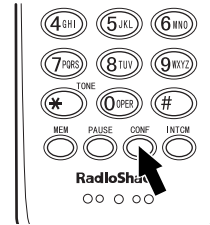

4. To end the conference call, press one line button, then the other. If you want to hang up one line and continue talking on the other, press the line button you want to hang up.

MAKING A CONFERENCE CALL

Three-Way Conference Call

Follow these steps to use both phone lines to set up a three-way call. The procedure is the same for the handset and the base

1. Make or answer a call on one line, then put that call on hold or simply press the other line's button.
2. Make or answer a call on the other line.

To talk on one line without disconnecting the other, press **HOLD**, then the button for the line you want to talk on. To return to a three-way conversation, press **CONF**.

Four-Way Conferencing

Follow these steps to use both lines and the ET-687's intercom function to set up a four-way call (see "Using Page/Intercom" on Page 19).

1. Make a three-way conference call.
2. Press **INTCM** on the handset or **INTERCOM** on the base to page the other keypad.

- To answer the page press **INTCM** on the handset or **INTERCOM** on the base, then press **CONF**.

To end the conference call, press **LINE 1** and **LINE 2** on one keypad, then press **LINE 2** on the other keypad.

To hang up one line and continue talking on the other, press the line button that you want to hang up.

Note: You can also make a conference call using both the ET-687 and an extension phone. (See "Using the ET-687 with Extension Phones).

USING THE ET-687 WITH EXTENSION PHONES

The ET-687 detects when an extension phone is in use, and the corresponding line indicator flashes.

To join the conversation from the handset or the base, press the line button for the line in use. You hear a warning tone (three long beeps). Before the warning tone ends, press the line button again.

Note: If you hang up the ET-687 when someone is still using an extension phone, the ET-687's line indicator might not stay lit.

USING FLASH

FLASH performs the electronic equivalent of a switchhook operation for special services, such as Call Waiting.

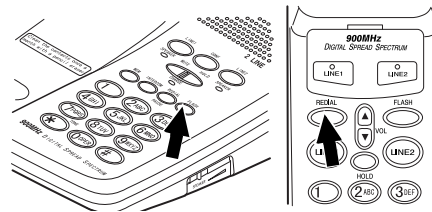

For example, if you have Call Waiting, press **FLASH** to answer an incoming call without disconnecting the current call. Press **FLASH** again to return to the first call.

Note: If you do not have any special services, pressing **FLASH** might disconnect the current call.

USING TONE SERVICES ON A PULSE LINE

Some special services, such as bank-by-phone, require tone signals. If you have pulse service, you can still use these special tone services by following these steps.

- Be sure **DIAL MODE** is set to **P**.
- Dial the service's main number.

3. When the service answers, press **-tone** (*). Any additional numbers you dial are sent as tone signals.

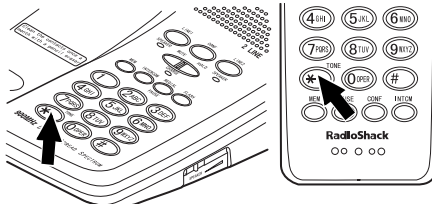

4. When you hang up, the phone automatically resets to pulse dialing.

USING PAGE/INTERCOM

You can use the ET-687 as a two-way pager and intercom between the base and the handset. This is useful if the handset is away from the base and you want to locate it, or if you want to have a conversation between someone with the handset and someone at the base.

To page the base from the handset, press **INTCM**. The base and handset ring. Press **INTERCOM** on the base to answer the page. Both line indicators on the handset light, and the **CHARGE** indicator on the base lights.

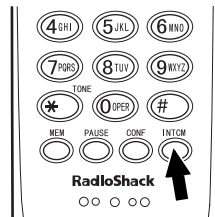

To page the handset from the base, press **INTERCOM**. The handset and base ring. Press **INTCM** on the handset to answer the page. Both line indicators on the handset light, and the **CHARGE** indicator on the base lights.

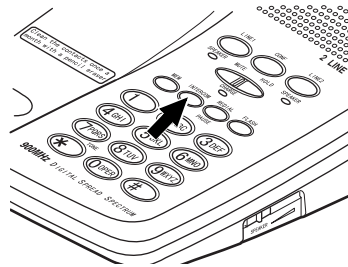

To end an intercom call, press **INTCM** on the handset, press **INTERCOM** on the base, or hang up the handset.

During a call, you can page someone at the base or the handset. Press **INTERCOM** (on the base) or **INTCM** (on the handset). The current call is put on hold.

- To transfer the call, press **INTERCOM** or **INTCM** again when the person at the handset or base answers.
- To start a three-way call, tell the person at the base or handset to press **LINE 1** (or **LINE 2**), then press the same button twice on your keypad when they answer the page.

Notes:

- You cannot page the base or handset if it is already in use. You will hear a warning tone.

- If a call comes in during an intercom conversation, either of the intercom parties can answer the call as they normally would. Simply press the ringing line's button. The intercom call automatically disconnects.

MEMORY DIALING

You can store up to 20 numbers in memory (ten each in the handset's and base's memory), then dial a stored number by pressing a one-digit memory location number.

Use the supplied memory directory stickers to record your stored numbers. (Use a pencil in case you need to change the number later.) Peel the backing from each sticker and attach them to the phone as shown.

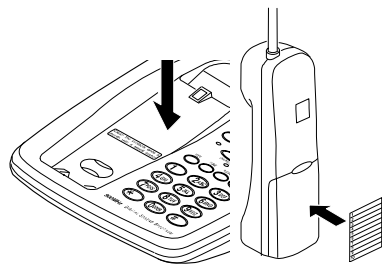

Notes:

- Each number stored in the handset's memory can be up to 20 digits, and each number stored in the base can be up to 16 digits.
- You cannot dial a number stored in one memory location (the base or the handset) using the keypad on the other.
- An error tone sounds and the phone exits the storing process if you wait more than 20 seconds between each keypress.

Storing a Number in Memory

Follow these steps to store a number in the handset's memory. To store a number in the base's memory, start at Step 2.

1. Lift the handset.
2. Press **MEM**. The **CHARGE** indicator on the base flashes, or the line indicators on the handset flash.

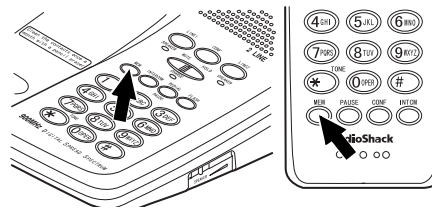

3. Enter the number and any tone and pause entries (see "Using Tone Services on a Pulse Line" on Page 18 and "Entering a Pause" on Page 21).

Note: Each tone or pause entry uses one digit of memory.

4. Press **MEM**, then enter the memory location number (**0–9**). A long beep confirms that the number is stored.

Note: If the phone sounds five quick beeps, you have made an entry error, and the number was not stored. Start again from Step 2.

To replace a stored number, simply store a new number in its place.

To erase a stored number, press **MEM** twice, then press the number for the memory location (**0–9**) you want to clear. A long beep sounds.

Note: You cannot store a number at the base while the handset is in use.

Entering a Pause

In some telephone systems, you must dial an access code (9, for example) and wait for a second dial tone before you can dial an outside number. You can store the access code with the phone number. However, you should also store a pause after the access code to allow the outside line time to connect.

To enter a 2-second pause, press **PAUSE** on the handset or base. You can add more pause entries for a longer pause.

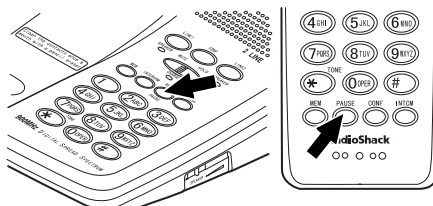

Dialing a Memory Number

To dial a number stored in the handset's memory, lift the handset and press either line button. When you hear a dial tone, press **MEM** and enter the memory location number for the number you want to dial.

To dial a number stored in the base's memory, press either line button. When you hear a dial tone, press **MEM** and enter the memory location number for the number you want to dial.

Chain-Dialing Service Numbers

For quick recall of numbers for special services (such as bank by phone), store each group of numbers in its own memory location.

Dial the service's main number first. Then, at the appropriate place in the call, press **MEM** and the number for the location where the additional information is stored.

Testing Stored Emergency Numbers

If you store an emergency service's number (police department, fire department, ambulance) and you choose to test the stored number, make the test call during the late evening or early morning hours to avoid peak demand periods. Also, remain on the line to explain the reason for your call.

USING A HEADSET

You can talk with hands-free convenience using an optional headset that has a $\frac{3}{32}$ -inch (2.5-mm) plug. Contact your local RadioShack store for a suitable headset.

To connect the headset, open the rubber cover marked  on the side of the handset, then insert the headset's plug into the jack.

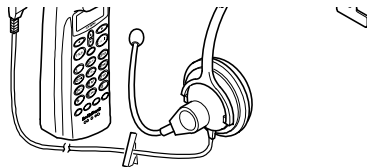

With a headset connected, you can make or answer calls as usual using the speakerphone or the keys on the handset.

You can use a headset holder (available at your local RadioShack store) to hang the handset on your belt for greater convenience.

When you finish using the headset, disconnect it from the handset and close the rubber cover to protect the jack.

Notes:

- Connecting a headset disconnects the handset's earpiece and microphone, but it does not affect the ET-687's speakerphone.
- **VOL** s or t on the handset also controls the connected headset's volume.
- If you place the handset on the base face down to recharge it while the headset is connected, be sure the handset seats properly.

TROUBLESHOOTING

We do not expect you to have any problems with your phone, but if you do, the following suggestions might help.

Problem	Suggestion
The phone does not work or works poorly.	Be sure the base's modular cord(s) and AC adapter are correctly and securely connected.
	Be sure the handset's battery pack is correctly connected and charged.
	Return the handset to the base for a few seconds to reset the security access-protection code.
The handset stops working or works poorly during a call.	Move the handset closer to the base.
	Lift the base's antenna to a vertical position.
	Be sure the handset's battery pack is correctly connected and charged.
Low volume or unusual sounds.	Someone has picked up another phone on the same line. Hang up the other phone.
Severe noise interference.	Keep the handset away from computers, remote control toys, wireless microphones, alarm systems, intercoms, room monitors, fluorescent lights, and electrical appliances.
	Move the base to another location or turn off the source of interference.
	Hang up and redial the number.
The handset cannot be operated at a useful distance from the base because the signal becomes weak or noisy (handset's range has decreased).	Lift the base's antenna to a vertical position.
	Be sure neither the handset's nor base's antenna is touching a metal surface.
	Recharge the battery pack.

Problem	Suggestion
The handset battery pack does not charge.	Check the charging contacts on the handset and base. If they are dirty, clean them with a pencil eraser.
	Be sure the battery pack is properly connected.
	Be sure the handset is properly seated on the base.
	Replace the battery pack (see "Replacing the Battery Pack" on Page 26).
The handset does not ring or receive a page.	Lift the base's antenna to a fully vertical position.
	Move the handset closer to the base.
	Move the base away from other electrical devices.
	Recharge the battery pack.

If you still have problems, disconnect the phone. If other phones on the same line work properly, the fault is in this phone or its installation. If you cannot find the problem, take your phone to your local RadioShack store for assistance.

CARE AND MAINTENANCE

Your RadioShack ET-687 Two-Line 900MHz Digital Spread Spectrum Cordless Telephone is an example of superior design and craftsmanship. The following suggestions will help you care for your ET-687 so you can enjoy it for years.



Keep the ET-687 dry. If it gets wet, wipe it dry immediately. Liquids might contain minerals that can corrode the electronic circuits.



Use and store the ET-687 only in normal temperature environments. Temperature extremes can shorten the life of electronic devices, damage battery packs, and distort or melt plastic parts.



Keep the ET-687 away from dust and dirt, which can cause premature wear of parts.



Handle the ET-687 gently and carefully. Dropping it can damage circuit boards and cases and can cause the ET-687 to work improperly.



Use only a battery pack of the required size and recommended type. Batteries can leak chemicals that damage your ET-687's electronic parts.



Wipe the ET-687 with a damp cloth occasionally to keep it looking new. Do not use harsh chemicals, cleaning solvents, or strong detergents to clean the ET-687.

Modifying or tampering with the ET-687's internal components can cause a malfunction and might invalidate its warranty and void your FCC authorization to operate it. If your ET-687 is not performing as it should, take it to your local RadioShack store for assistance. If the trouble is affecting the telephone lines, the phone company can ask you to disconnect your ET-687 until you have resolved the problem.

REPLACING THE BATTERY PACK

If you follow the instructions in "Connecting and Charging the Battery Pack" on Page 11, the battery pack should last about one year. If the battery pack does not hold a charge for more than 2 hours after an overnight charge, replace it with a new 3.6-volt, 600 mAh battery pack with a connector that fits the socket in the battery compartment. You can order a replacement battery pack through your local RadioShack store.

Install the new battery pack as described below, then charge it for about 24 hours.

Note: To avoid losing memory numbers, try to install and begin charging the new battery pack within 1 minute.

1. Press down and slide off the battery pack compartment cover as shown.

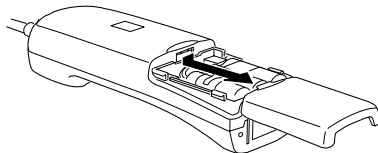

2. Unfasten the plastic retainer strap and lift the battery pack out of the compartment, then gently pull on the battery connector to disconnect it.
3. Insert the new battery pack's connector into the socket in the compartment, place the battery pack into the compartment, and refasten the retainer strap.

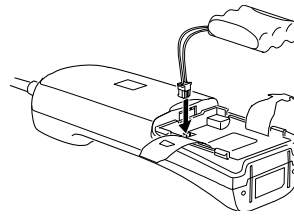

4. Replace the cover.

Cautions:

- You must use a replacement battery pack of the same size and type.
- Do not dispose of the battery pack in a fire because it might explode.
- Do not open or mutilate the battery pack.
- Be careful not to short the battery pack by touching the connector's pins with conducting materials, such as rings, bracelets, and keys. The battery pack or conductor might overheat and burn.

If you have trouble replacing the battery pack, take the phone to your local RadioShack store for assistance.

Important: This product contains a rechargeable nickel-cadmium battery pack. At the end of the battery pack's useful life, it must be recycled or disposed of properly. Contact your local, county, or state hazardous waste management authorities for information on recycling or disposal programs in your area. Some options that might be available are: municipal curb-side collection, drop-off boxes at retailers such as your local RadioShack store, recycling collection centers, and mail-back programs.

THE FCC WANTS YOU TO KNOW

In the unlikely event that your phone causes problems on the phone line, the phone company can temporarily discontinue your service. If this happens, the phone company attempts to notify you in advance. If advance notice is not practical, the phone company notifies you as soon as possible and advises you of your right to file a complaint with the FCC.

Also, the phone company can make changes to its lines, equipment, operations, or procedures that could affect the operation of this telephone. The telephone company notifies you of these changes in advance, so you can take the necessary steps to prevent interruption of your telephone service.

Your phone might cause TV or radio interference even when it is operating properly. To determine whether your phone is causing the interference, turn off your phone. If the interference goes away, your phone is causing it. Try to eliminate the interference by:

- moving your phone away from the receiver
- connecting your phone to an AC outlet that is on a different electrical circuit from the receiver
- contacting your local RadioShack store for help

If you cannot eliminate the interference, the FCC requires that you stop using your phone.

Some cordless telephones operate on frequencies that might cause interference to nearby TVs and VCRs. To minimize or prevent such interference, the base of the cordless telephone should not be placed near or on top of a TV or VCR.

LIGHTNING

Your telephone has built-in lightning protection to reduce the risk of damage from surges in telephone line and power line current. This lightning protection meets or exceeds FCC requirements. However, lightning striking the telephone or power lines can damage your telephone.

Lightning damage is not common. Nevertheless, if you live in an area that has severe electrical storms, we suggest that you unplug your phone during storms to reduce the possibility of damage.

Limited One-Year Warranty

This product is warranted by RadioShack against manufacturing defects in material and workmanship under normal use for one (1) year from the date of purchase from RadioShack company-owned stores and authorized RadioShack franchisees and dealers. EXCEPT AS PROVIDED HEREIN, RadioShack MAKES NO EXPRESS WARRANTIES AND ANY IMPLIED WARRANTIES, INCLUDING THOSE OF MERCHANTABILITY AND FITNESS FOR A PARTICULAR PURPOSE, ARE LIMITED IN DURATION TO THE DURATION OF THE WRITTEN LIMITED WARRANTIES CONTAINED HEREIN. EXCEPT AS PROVIDED HEREIN, RadioShack SHALL HAVE NO LIABILITY OR RESPONSIBILITY TO CUSTOMER OR ANY OTHER PERSON OR ENTITY WITH RESPECT TO ANY LIABILITY, LOSS OR DAMAGE CAUSED DIRECTLY OR INDIRECTLY BY USE OR PERFORMANCE OF THE PRODUCT OR ARISING OUT OF ANY BREACH OF THIS WARRANTY, INCLUDING, BUT NOT LIMITED TO, ANY DAMAGES RESULTING FROM INCONVENIENCE, LOSS OF TIME, DATA, PROPERTY, REVENUE, OR PROFIT OR ANY INDIRECT, SPECIAL, INCIDENTAL, OR CONSEQUENTIAL DAMAGES, EVEN IF RadioShack HAS BEEN ADVISED OF THE POSSIBILITY OF SUCH DAMAGES.

Some states do not allow the limitations on how long an implied warranty lasts or the exclusion of incidental or consequential damages, so the above limitations or exclusions may not apply to you.

In the event of a product defect during the warranty period, take the product and the RadioShack sales receipt as proof of purchase date to any RadioShack store. RadioShack will, at its option, unless otherwise provided by law: (a) correct the defect by product repair without charge for parts and labor; (b) replace the product with one of the same or similar design; or (c) refund the purchase price. All replaced parts and products, and products on which a refund is made, become the property of RadioShack. New or reconditioned parts and products may be used in the performance of warranty service. Repaired or replaced parts and products are warranted for the remainder of the original warranty period. You will be charged for repair or replacement of the product made after the expiration of the warranty period.

This warranty does not cover: (a) damage or failure caused by or attributable to acts of God, abuse, accident, misuse, improper or abnormal usage, failure to follow instructions, improper installation or maintenance, alteration, lightning or other incidence of excess voltage or current; (b) any repairs other than those provided by a RadioShack Authorized Service Facility; (c) consumables such as fuses or batteries; (d) cosmetic damage; (e) transportation, shipping or insurance costs; or (f) costs of product removal, installation, set-up service adjustment or reinstallation.

This warranty gives you specific legal rights, and you may also have other rights which vary from state to state.

RadioShack Customer Relations, Dept. W, 100 Throckmorton St., Suite 600, Fort Worth, TX 76102

We Service What We Sell

3/97

RadioShack
A Division of Tandy Corporation
Fort Worth, Texas 76102

UCZZ01606BZ
Printed in the Philippines

11A8N

Free Manuals Download Website

<http://myh66.com>

<http://usermanuals.us>

<http://www.somanuals.com>

<http://www.4manuals.cc>

<http://www.manual-lib.com>

<http://www.404manual.com>

<http://www.luxmanual.com>

<http://aubethermostatmanual.com>

Golf course search by state

<http://golfingnear.com>

Email search by domain

<http://emailbydomain.com>

Auto manuals search

<http://auto.somanuals.com>

TV manuals search

<http://tv.somanuals.com>