



Cat. No. 43-1051  
**OWNER'S MANUAL**

Please read before using this equipment.

**ET-551**

**25-Channel  
Cordless Phone**  
with 10-Number Memory



**RadioShack®**

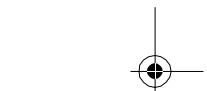
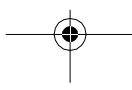

## FEATURES

---

Your RadioShack ET-551 25-Channel Cordless Phone with 10-Number Memory is designed to exacting standards that ensure reliability, long life, and outstanding performance.

Its features include:

**25 Channels** — automatically scans to find the first clear channel available and lets you change to a clearer channel during a call to reduce static interference.

**10-Number Memory Dialing** — lets you store up to 16 digits in each of ten memory locations for easy dialing.

**Super CCT Noise-Reduction Circuitry** — gives you sound clarity comparable to that of a corded phone.

**Security Access-Protection Code** — automatically prevents other cordless phone users from using your phone line while the handset is off the base.

**COM-LOK<sup>®</sup>** — ensures that other cordless phone users cannot use your phone line when the handset is on the base.

**Redial** — lets you quickly redial the last number dialed.

**Page** — lets you send a paging signal from the base to the handset to page someone or locate the handset if you misplace it.

**Flash** — sends an electronic switch-hook signal for use with special phone services, such as Call Waiting.

**Tone/Pulse Dialing** — lets you use your phone with either type of service.

**Hearing-Aid Compatibility** — lets you use your phone with hearing aids that have a T (telephone) switch.



This telephone has been tested and found to comply with all applicable UL and FCC standards.

© 1997 Tandy Corporation.  
All Rights Reserved.

COM-LOK and RadioShack are registered trademarks used by Tandy Corporation.

**Important Note:** Cordless phones such as this one require AC power to operate. When the AC power is off, you cannot dial out or receive incoming calls using your ET-551. To be safe, you should also have a phone that does not need AC power to operate (not a cordless phone) so you can still make and receive calls if there is an AC power failure.

**WARNING:** To reduce the risk of fire or shock hazard, do not expose this product to rain or moisture.

	<b>CAUTION</b> RISK OF ELECTRIC SHOCK. DO NOT OPEN.	
<p><b>CAUTION:</b> TO REDUCE THE RISK OF ELECTRIC SHOCK, DO NOT REMOVE COVER OR BACK. NO USER-SERVICEABLE PARTS INSIDE. REFER SERVICING TO QUALIFIED PERSONNEL.</p>		



This symbol is intended to alert you to the presence of uninsulated dangerous voltage within the product's enclosure that might be of sufficient magnitude to constitute a risk of electric shock. Do not open the product's case.



This symbol is intended to inform you that important operating and maintenance instructions are included in the literature accompanying this product.

## READ THIS BEFORE INSTALLATION

Each device that you connect to the phone line draws power from the phone line. We refer to this power draw as the device's *ringer equivalence number*, or REN. The REN is shown on the bottom of the base.

If you are using more than one phone or other device on the line, add up all the RENs. If the total is more than five, your phones might not ring. In rural areas, a total REN of three might impair ringer operation. If ringer operation is impaired, remove a device from the line.

## FCC STATEMENT

This telephone complies with Part 68 of *FCC Rules*. You must, upon request, provide the FCC Registration Number and the REN to your phone company. These numbers are shown on the bottom of the base.

**Note:** You must not connect your phone to any of the following:

- coin-operated systems
- party-line systems
- most electronic key phone systems

# CONTENTS

---

<b>Installation .....</b>	<b>5</b>
Installing the Handset's Antenna .....	5
Selecting a Location .....	5
Placing the Base on a Desk Top .....	6
Mounting the Base on a Wall Plate .....	6
Mounting the Base Directly on the Wall .....	8
Connecting and Charging the Battery Pack .....	9
Setting the Dialing Mode .....	11
Turning the Ringer On or Off .....	11
Setting the Volume .....	11
<b>Operation .....</b>	<b>12</b>
Making and Receiving Calls .....	12
Changing the Channel .....	12
Using Redial .....	12
Using Flash .....	13
Using Tone Services on a Pulse Line .....	13
Paging .....	14
Memory Dialing .....	14
Storing a Number in Memory .....	14
Entering a Pause .....	15
Dialing a Memory Number .....	15
Chain-Dialing Service Numbers .....	15
Testing Stored Emergency Numbers .....	15
<b>Troubleshooting .....</b>	<b>16</b>
<b>Care and Maintenance .....</b>	<b>18</b>
Replacing the Battery Pack .....	19
The FCC Wants You to Know .....	20
Lightning .....	21

## INSTALLATION

### INSTALLING THE HANDSET'S ANTENNA

Insert the antenna into the hole at the top of the handset, then rotate the antenna clockwise until it is secure.



### SELECTING A LOCATION

You can place the phone on a desk top or table, or mount it on a wall. Select a location that is:

- Near an AC outlet
- Near a telephone line jack
- Out of the way of normal activities
- Away from electrical machinery, electrical appliances, metal walls or filing cabinets, wireless intercoms, alarms, and room monitors
- Away from other cordless phones

The base's location affects the handset's range. If you have a choice of several locations, try each to see which provides the best performance.

**Caution:** The supplied RadioShack adapter was designed specifically for your ET-551. Use only the supplied adapter.

#### Notes:

- Your telephone connects directly to a modular telephone line jack. If your phone line jack is not a modular jack, you can update the wiring yourself, using jacks and adapters available at your local RadioShack store. Or, you can let the phone company update the wiring for you.
- The USOC number of the jack to be installed is RJ11C (RJ11W if you want to mount it on a wall plate).

## Placing the Base on a Desk Top

Follow these steps when you place the base on a desk, shelf, or table.

1. Plug one end of the supplied long modular cord into the **LINE** jack on the back of the base.

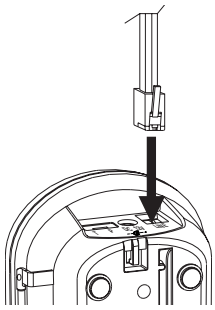

2. Insert the supplied power adapter's barrel plug into the **DC 12V** jack on the back of the base.

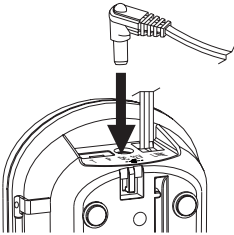

3. Route the adapter's cord through the strain relief slot on top of the base.

Strain Relief Slot

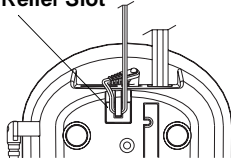

4. Plug the adapter into a standard AC outlet.

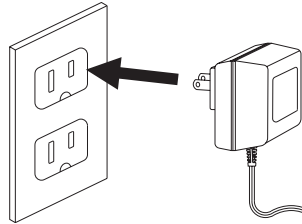

5. Plug the modular cord's other end into a modular phone line jack.

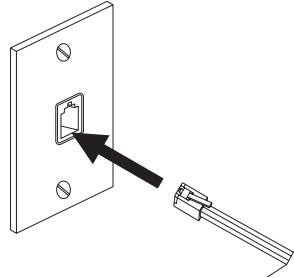

6. Fully extend the base's antenna and place it in a vertical position.

## Mounting the Base on a Wall Plate

1. Plug one end of the supplied short modular cord into the **LINE** jack on the back of the base.

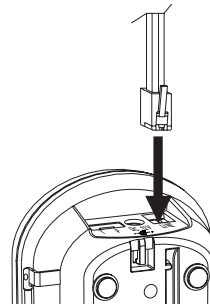

2. Insert the supplied power adapter's barrel plug into the **DC 12V** jack on the back of the base.

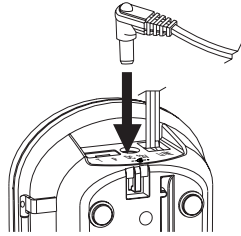

3. Route the modular cord through the groove on the bottom of the base and the adapter cord through the strain relief slot on top of the base.

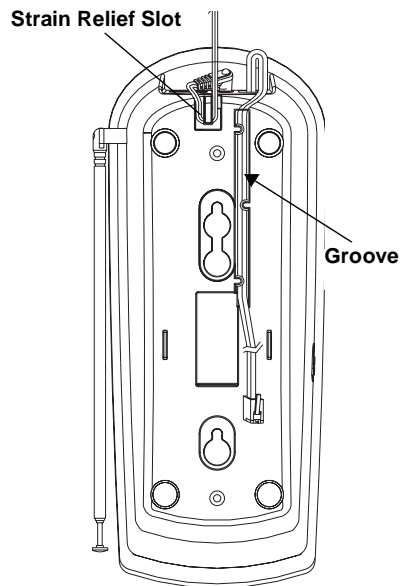

4. Plug the adapter into a standard AC outlet.

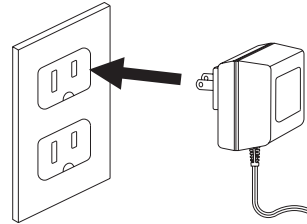

5. Plug the short modular cord's other end into the wall plate jack, then align the base's keyhole slots with the wall plate studs and slide the base downward to secure it.

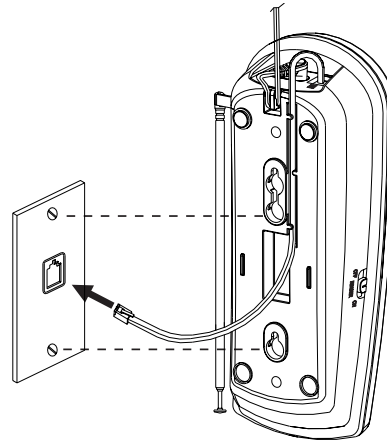

6. Fully extend the base's antenna and place it in a vertical position.

## Mounting the Base Directly on the Wall

For this mounting method, you need two wood screws (not supplied) with heads that fit into the keyhole slots on the bottom of the base.

1. Drill two holes  $3\frac{15}{16}$  inches apart. Then thread a screw into each hole, letting the heads extend about  $\frac{5}{16}$  inch from the wall.

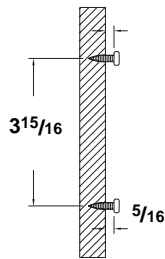

2. Plug one end of the supplied short modular cord into the **LINE** jack on the back of the base.

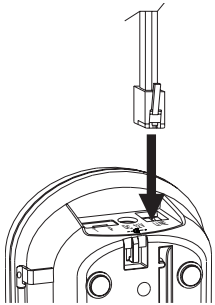

3. Insert the supplied power adapter's barrel plug into the **DC 12V** jack on the back of the base.

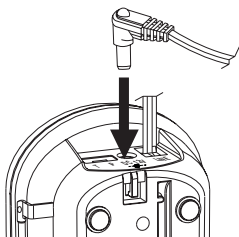

4. Route the adapter's cord through the strain relief slot on top of the base.

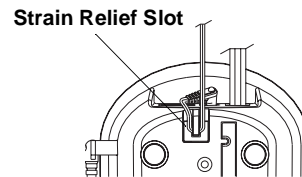

5. Align the keyhole slots with the mounting screws and slide the base downward to secure it.

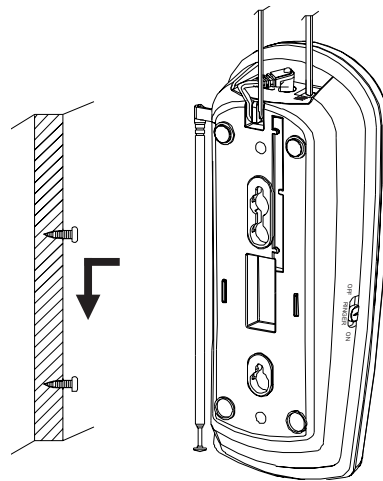

6. Plug the adapter into a standard AC outlet.

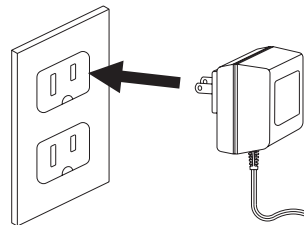



7. Plug the cord's other end into a modular phone line jack.

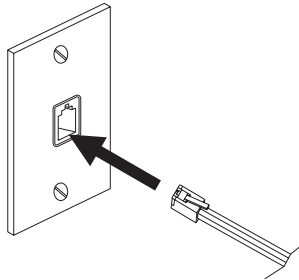

8. Fully extend the base's antenna and place it in a vertical position.

## CONNECTING AND CHARGING THE BATTERY PACK

The ET-551 comes with a rechargeable nickel-cadmium battery pack. Before using your phone, you must connect the battery pack then charge it for about 24 hours.

Follow these steps to charge the battery pack.

1. Press down and slide off the handset's battery compartment cover as shown.

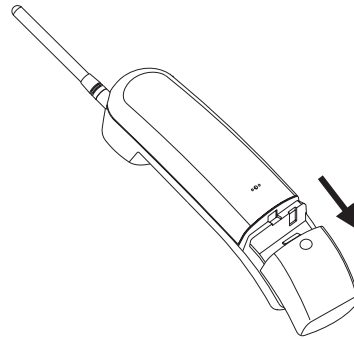

2. Insert the battery pack's connector into the phone's socket. The plug fits only one way.

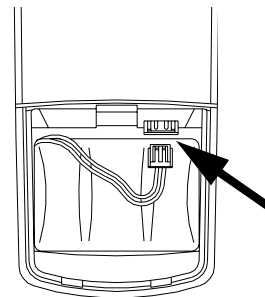

3. Replace the cover.

4. To charge the battery pack, simply place the handset on the base.

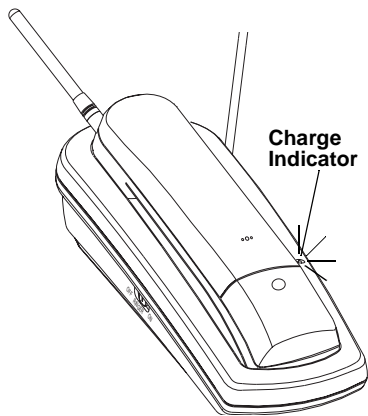

The CHARGE indicator on the base lights.

Recharge the battery pack when the LOW BATT indicator on the handset flashes.

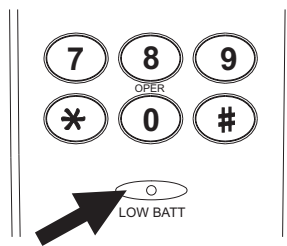

**Notes:**

- If the CHARGE indicator does not light when you place the handset on the base, be sure the battery pack and AC adapter are correctly and securely connected.
- When you first use the phone after charging or recharging the battery pack, the phone might not work and you might hear an error tone.

If this happens, return the handset to the base for a few seconds.

- If the LOW BATT indicator does not light, but the phone does not work, recharge the battery pack. The battery voltage might be too low to light the indicator.
- If the battery pack gets weak during a call, the handset sounds three beeps every 30 seconds, and the LOW BATT indicator flashes for 2 minutes. After 2 minutes, the phone automatically disconnects. If this happens, you cannot make another call on the phone until you recharge the battery pack.
- About every 30 days, fully discharge the battery pack by keeping the handset off the base until the LOW BATT indicator lights. Otherwise, the battery pack loses its ability to fully recharge.
- Using a pencil eraser, clean the charging contacts on the handset and the base about once a month to make sure they are not dirty or tarnished.

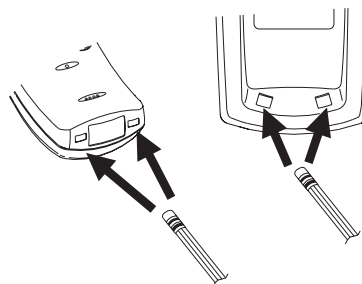

- If the battery pack gets completely discharged, the ET-551 loses the security access-protection code. To reset the code, place the handset on the base and charge the battery pack.
- The supplied battery pack should last about a year. When the battery pack loses its ability to fully recharge, order a replacement battery pack from your local RadioShack store (see "Replacing the Battery Pack" on Page 19).

## SETTING THE DIALING MODE

Set **T/P** (Tone/Pulse) on the back of the base for the type of service you have. If you are not sure which type you have, do this test.

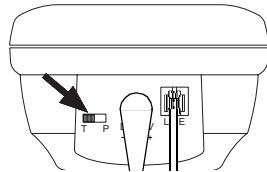

1. Set **T/P** to **T**.
2. Lift the handset, press **TALK**, and listen for a dial tone.
3. Press any number other than **0**.

**Note:** If your phone system requires that you dial an access code (**9**, for example) before you dial an outside number, do not press the access code either.

If the dial tone stops, you have touch-tone service. Leave **T/P** set to **T**.

If the dial tone continues, you have pulse service. Set **T/P** to **P**.

## TURNING THE RINGER ON OR OFF

To turn off the ringer, set **RINGER** on the base to **OFF**. To turn on the ringer, set it to **ON**.

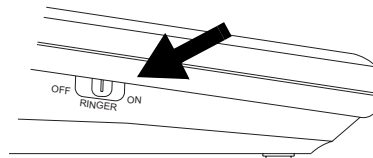

**Note:** With the base's ringer off, you can still make calls using the phone. You can also receive calls if you hear another telephone on the same line ringing.

## SETTING THE VOLUME

Adjust **VOLUME** on the side of the handset to control the volume of the sound you hear through the handset.

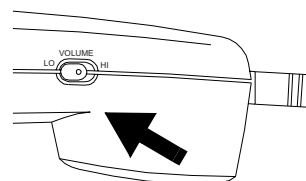

## OPERATION

### MAKING AND RECEIVING CALLS

To make a call, pick up the handset and press **TALK**. When the TALK indicator lights steadily and you hear the dial tone, dial the phone number.

To answer a call if the handset is on the base, simply lift the handset and begin your conversation.

To answer a call if the handset is not on the base, press **TALK** on the handset before speaking.

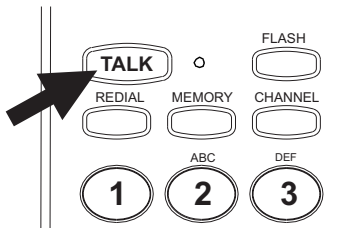

To end a call, place the handset on the base or press **TALK**.

**Note:** If you press **TALK** to hang up and the phone does not disconnect, place the handset on the base or press **TALK** again while holding the handset closer to the base.

### CHANGING THE CHANNEL

The ET-551 finds a clear channel for each call, but if you notice interference during a call, you can press **CHANNEL** to find a clearer channel.

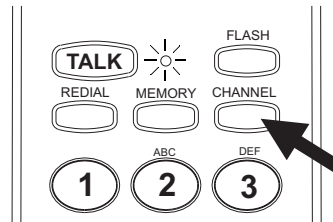

The ET-551 changes to a different channel each time you press **CHANNEL**.

**Note:** If the handset is too far from the base, the channel might not change. Move closer to the base and try again.

### USING REDIAL

**REDIAL** lets you quickly dial the last number dialed. When you hear the dial tone after pressing **TALK**, simply press **REDIAL**.

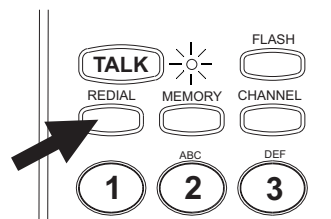

**Note:** The redial memory does not store a flash entry (see "Using Flash" on Page 13).

## USING FLASH

**FLASH** performs the electronic equivalent of a switchhook operation for special services, such as Call Waiting.

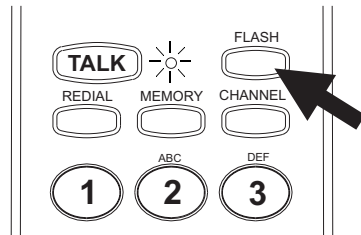

For example, if you have Call Waiting, press **FLASH** to answer an incoming call without disconnecting the current call. Press **FLASH** again to return to the first call.

**Note:** If you do not have any special phone services, pressing **FLASH** might disconnect the current call.

## USING TONE SERVICES ON A PULSE LINE

Some special services, such as bank-by-phone, require tone signals. If you have pulse service, you can still use these special tone services by following these steps.

1. Be sure **T/P** is set to **P**.
2. Press **TALK**.
3. When you hear the dial tone, dial the service's main number.
4. When you want to send tone signals, press **\***. Any additional numbers you dial are sent as tone signals.

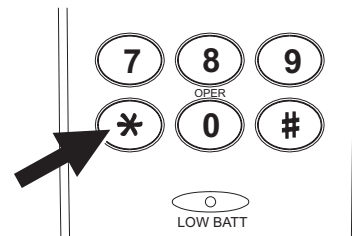

5. After you complete the call, return the handset to the base or press **TALK**. The phone automatically resets to the pulse mode.

## PAGING

To page the person who has the handset or to locate the handset when the phone is not in use, press **PAGE** on the base. The handset beeps three times. If you hold down **PAGE** for 2 seconds, the handset beeps for 30 seconds to give you time to locate the handset.

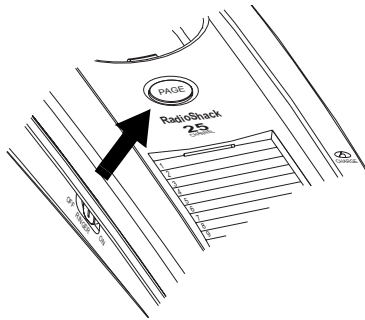

## MEMORY DIALING

You can store up to 16 digits in each of the ten memory locations, then dial a stored number by pressing a one-digit memory location number.

### Storing a Number in Memory

**Note:** An error tone sounds and the phone exits the programming mode if you wait more than about 6 seconds between each key press or enter more than 16 digits.

1. Press **MEMORY**. The TALK indicator flashes.

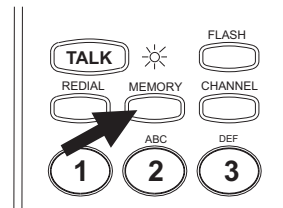

2. Enter the phone number and any tone and pause entries (see "Using Tone Services on a Pulse Line" on Page 13 and "Entering a Pause" on Page 15).

**Note:** Each tone or pause entry uses one digit of memory.

3. Press **MEMORY**, then enter the memory location number (0–9). A single tone sounds to indicate that the number is stored.

Repeat Steps 2–4 for each number you want to store.

**Note:** If three quick beeps sound, you have made an error and the number was not stored. Start again from Step 2.

For each stored number, write the person's or company's name next to the appropriate location number on the memory dialing card. We recommend you use a pencil in case you want to change the number later.

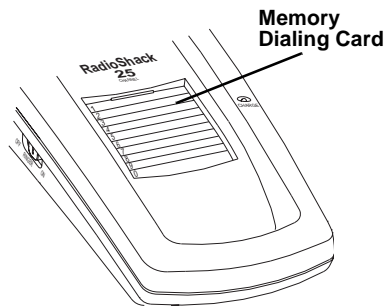

To erase a stored number, simply store a new number in its place.

### Entering a Pause

In some telephone systems, you must dial an access code (9, for example) and wait for a second dial tone before you can dial an outside number. You can store the access code with the phone number. However, you should also store a pause after the access code to allow the outside line time to connect.

To do so, press **REDIAL** at the appropriate place to enter a 4-second pause. For a longer pause, press **REDIAL** additional times.

### Dialing a Memory Number

To dial a number stored in memory, press **TALK**. When you hear a dial tone, press **MEMORY** and enter the memory location number for the number you want to dial.

### Chain-Dialing Service Numbers

When calling special services (such as alternate long distance or bank by phone), dial the service's main number first. Then, at the appropriate place in the call, press **MEMORY** then the number for the location where the additional information is stored.

### Testing Stored Emergency Numbers

If you store an emergency service's number (police department, fire department, ambulance) and you choose to test the stored number, make the test call during the late evening or early morning hours to avoid peak demand periods. Also, remain on the line to explain the reason for your call.

## TROUBLESHOOTING

We do not expect you to have any problems with your phone, but if you do, the following suggestions might help.

Problem	Suggestion
Low volume or unusual sounds.	Someone has picked up another phone on the same line. Hang up the other phone.
	Press <b>CHANNEL</b> to change the channel.
	Adjust the handset's volume.
Severe noise interference.	Press <b>CHANNEL</b> to change the channel.
	Keep the handset away from computers, remote control toys, wireless microphones, alarm systems, intercoms, room monitors, fluorescent lights, and electrical appliances.
	Move to another location or turn off the source of the interference.
The phone cannot be operated at a useful distance from the base because the signal becomes weak or noisy (handset's range has decreased).	Fully extend the base's antenna in a vertical position.
	Be sure neither antenna is touching a metal surface.
	Return the handset to the base to recharge the battery pack.
The phone does not work or works poorly.	Be sure the base's phone line cord and AC adapter are correctly and securely connected, and the battery pack is charged.
The handset battery pack does not charge.	Check the charging contacts on the handset and base. If they are dirty, clean them with a pencil eraser.
	Be sure the battery pack is connected correctly.
	Replace the battery pack.



Problem	Suggestion
The handset does not ring or receive a page.	The battery pack might be weak. Charge the battery pack.
	Extend the base's antenna vertically.
	Move the handset closer to the base.
	Move the base away from other electrical devices and sources of noise.
The handset stops working or works poorly during a call.	Move the handset closer to the base.
	Fully extend the base's antenna, and place it in a vertical position.
	Check the charging contacts on the handset and base. If they are dirty, clean them with a pencil eraser.
	Be sure the handset's battery pack is charged. (If the battery power is too low, it does not have enough power to light the LOW BATT indicator.)
The call is too noisy.	Change channels or hang up and redial the number.

If you still have problems, disconnect the phone. If other phones on the same line work properly, the fault is in this phone or its installation. If you cannot find the problem, take your phone to your local RadioShack store for assistance.

## CARE AND MAINTENANCE

Your RadioShack ET-551 25-Channel Cordless Phone with 10-Number Memory is an example of superior design and craftsmanship. The following suggestions will help you care for your cordless phone so you can enjoy it for years.



Keep the phone dry. If it gets wet, wipe it dry immediately. Liquids might contain minerals that can corrode the electronic circuits.



Handle the phone gently and carefully. Dropping it can damage circuit boards and cases and can cause the phone to work improperly.



Use and store the phone only in normal temperature environments. Temperature extremes can shorten the life of electronic devices, damage batteries, and distort or melt plastic parts.



Keep the phone away from dust and dirt, which can cause premature wear of parts.



Wipe the phone with a damp cloth occasionally to keep it looking new. Do not use harsh chemicals, cleaning solvents, or strong detergents to clean the phone.

Modifying or tampering with the phone's internal components can cause a malfunction and might invalidate your phone's warranty and void your FCC authorization to operate it. If your phone is not performing as it should, take it to your local RadioShack store for assistance. If the trouble is affecting the phone lines, the phone company might ask you to disconnect your phone until you have resolved the problem.

## REPLACING THE BATTERY PACK

If you follow the instructions in "Connecting and Charging the Battery Pack" on Page 9, the battery pack should last about one year. If the battery pack will not hold a charge for more than 2 hours after an overnight charge, replace it with a new 3.6 V, 300 mAh battery pack with a connector that fits the socket in the battery compartment. You can order a replacement battery pack through your local RadioShack store.

Install the new battery pack as described here, then charge the battery pack (see "Connecting and Charging the Battery Pack" on Page 9).

**Note:** To avoid losing phone numbers stored in memory, try to install and begin charging the new battery pack within about 2 minutes.

1. Press down and slide off the handset's battery compartment cover as shown.

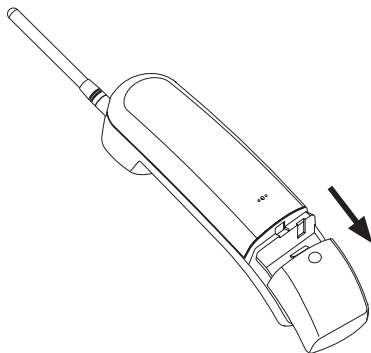

2. Gently pull out the battery connector to disconnect it, then remove the battery pack.
3. Insert a fresh battery pack and insert its connector into the socket inside the battery compartment.

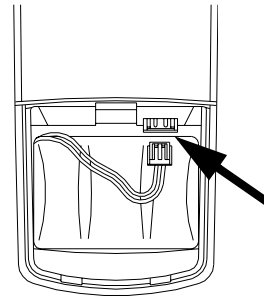

4. Replace the cover.

### Cautions:

- You must use a replacement battery pack of the same size and type.
- Do not dispose of the battery pack in a fire because it might explode.
- Do not open or mutilate the battery pack.
- Be careful not to short the battery pack by touching it with conducting materials, such as rings, bracelets, and keys. The battery pack or conductor might overheat and burn.

**Important:** This phone contains a rechargeable nickel-cadmium battery pack. At the end of the battery pack's useful life, it must be recycled or disposed of properly. Contact your local, county, or state hazardous waste management authorities for information on recycling or disposal programs in your area. Some options that might be available are: municipal curb-side collection, drop-off boxes at retailers such as your local RadioShack store, recycling collection centers, and mail-back programs.

## THE FCC WANTS YOU TO KNOW

In the unlikely event that your phone causes problems on the phone line, the phone company can temporarily discontinue your service. If this happens, the phone company attempts to notify you in advance. If advance notice is not practical, the phone company notifies you as soon as possible and advises you of your right to file a complaint with the FCC.

Also, the phone company can make changes to its lines, equipment, operations, or procedures that could affect the operation of this telephone. The telephone company notifies you of these changes in advance, so you can take the necessary steps to prevent interruption of your telephone service.

Your phone might cause TV or radio interference even when it is operating properly. To determine whether your phone is causing the interference, turn off your phone. If the interference goes away, your phone is causing the interference.

Try to eliminate the interference by:

- Moving your phone away from the receiver
- Connecting your phone to an AC outlet that is on a different electrical circuit from the receiver
- Contacting your local RadioShack store for help

If you cannot eliminate the interference, the FCC requires that you stop using your phone.

Some cordless phones operate at frequencies that might cause interference to nearby TVs and VCRs. To minimize or prevent such interference, the base of the cordless phone should not be placed near or on top of a TV or VCR.

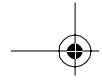

---

## LIGHTNING

Your telephone has built-in lightning protection to reduce the risk of damage from surges in telephone line and power line current. This lightning protection meets or exceeds FCC requirements. However, lightning striking the telephone or power lines can damage your telephone.

Lightning damage is not common. Nevertheless, if you live in an area that has severe electrical storms, we suggest you unplug your phone during storms to reduce the possibility of damage.

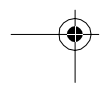
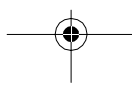
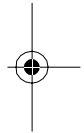
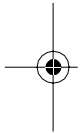



# NOTES

---

---

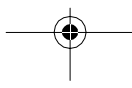
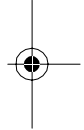
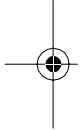

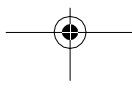
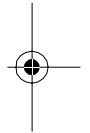
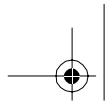



### Limited One-Year Warranty

This product is warranted by RadioShack against manufacturing defects in material and workmanship under normal use for one (1) year from the date of purchase from RadioShack company-owned stores and authorized RadioShack franchisees and dealers. EXCEPT AS PROVIDED HEREIN, RadioShack MAKES NO EXPRESS WARRANTIES AND ANY IMPLIED WARRANTIES, INCLUDING THOSE OF MERCHANTABILITY AND FITNESS FOR A PARTICULAR PURPOSE, ARE LIMITED IN DURATION TO THE DURATION OF THE WRITTEN LIMITED WARRANTIES CONTAINED HEREIN. EXCEPT AS PROVIDED HEREIN, RadioShack SHALL HAVE NO LIABILITY OR RESPONSIBILITY TO CUSTOMER OR ANY OTHER PERSON OR ENTITY WITH RESPECT TO ANY LIABILITY, LOSS OR DAMAGE CAUSED DIRECTLY OR INDIRECTLY BY USE OR PERFORMANCE OF THE PRODUCT OR ARISING OUT OF ANY BREACH OF THIS WARRANTY, INCLUDING, BUT NOT LIMITED TO, ANY DAMAGES RESULTING FROM INCONVENIENCE, LOSS OF TIME, DATA, PROPERTY, REVENUE, OR PROFIT OR ANY INDIRECT, SPECIAL, INCIDENTAL, OR CONSEQUENTIAL DAMAGES, EVEN IF RadioShack HAS BEEN ADVISED OF THE POSSIBILITY OF SUCH DAMAGES.

Some states do not allow the limitations on how long an implied warranty lasts or the exclusion of incidental or consequential damages, so the above limitations or exclusions may not apply to you.

In the event of a product defect during the warranty period, take the product and the RadioShack sales receipt as proof of purchase date to any RadioShack store. RadioShack will, at its option, unless otherwise provided by law: (a) correct the defect by product repair without charge for parts and labor; (b) replace the product with one of the same or similar design; or (c) refund the purchase price. All replaced parts and products, and products on which a refund is made, become the property of RadioShack. New or reconditioned parts and products may be used in the performance of warranty service. Repaired or replaced parts and products are warranted for the remainder of the original warranty period. You will be charged for repair or replacement of the product made after the expiration of the warranty period.

This warranty does not cover: (a) damage or failure caused by or attributable to acts of God, abuse, accident, misuse, improper or abnormal usage, failure to follow instructions, improper installation or maintenance, alteration, lightning or other incidence of excess voltage or current; (b) any repairs other than those provided by a RadioShack Authorized Service Facility; (c) consumables such as fuses or batteries; (d) cosmetic damage; (e) transportation, shipping or insurance costs; or (f) costs of product removal, installation, set-up service adjustment or reinstallation.

This warranty gives you specific legal rights, and you may also have other rights which vary from state to state.

RadioShack Customer Relations, Dept. W, 100 Throckmorton St., Suite 600, Fort Worth, TX 76102

*We Service What We Sell*

3/97

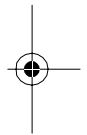
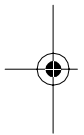

**RadioShack**  
A Division of Tandy Corporation  
Fort Worth, Texas 76102

8A7

Printed in China

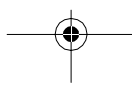



## Free Manuals Download Website

<http://myh66.com>

<http://usermanuals.us>

<http://www.somanuals.com>

<http://www.4manuals.cc>

<http://www.manual-lib.com>

<http://www.404manual.com>

<http://www.luxmanual.com>

<http://aubethermostatmanual.com>

Golf course search by state

<http://golfingnear.com>

Email search by domain

<http://emailbydomain.com>

Auto manuals search

<http://auto.somanuals.com>

TV manuals search

<http://tv.somanuals.com>