

MD501 MIDI Keyboard with Mini-Size Keys

42-4059

Music Information Display — shows you the notes and chords as you play them, along with the current tone, rhythm, and tempo.

Recording/Playback — lets you record your own tunes and play them back at any time.

Tempo Controls — let you speed up or slow down the tempo of any selected music pattern.

Sustain Function — lets you extend the length of a played note, providing added flexibility as you make music.

Metronome — the keyboard sounds the beat, making it easy to keep time with the music.

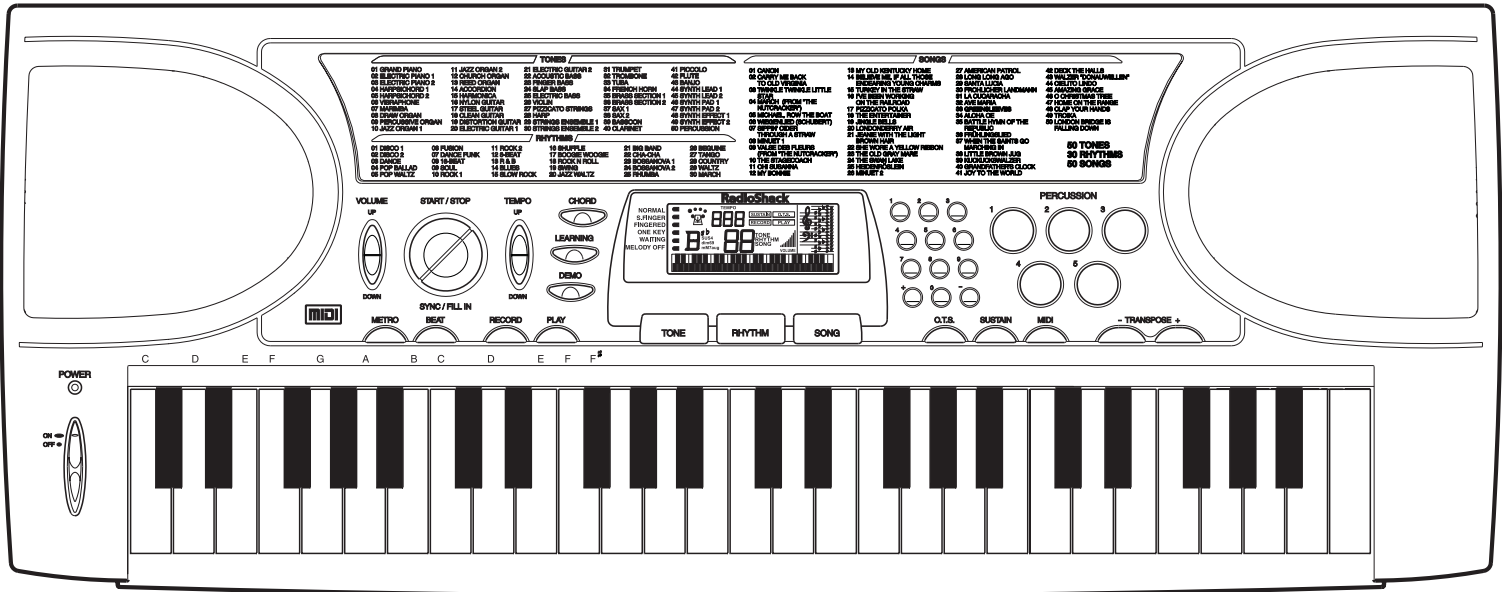

CONTENTS

Introduction	2	Using the Preset Auto-Rhythms	4	Using a Percussion Pad	7
Connecting Power	2	Selecting/Playing an Auto-Rhythm	4	Recording/Playing a Percussion Pad Sound ..	7
Using Batteries	2	Using SYNC	5	Transposing	7
Using AC or DC Power	2	Using FILL-IN	5	Using MIDI	8
Connecting Headphones	2	Using Auto Accompaniment	5	About MIDI	8
Listening Safely	2	Single Fingering	5	Making the MIDI Connections	8
Connecting an External Amplifier	2	Standard Fingering	6	Troubleshooting	9
A Quick Look at Your Keyboard	3	Learning to Play	6	Care	9
Operation	4	Using the Metronome	6	Service and Repair	9
Basic Operation	4	Using BEAT	7	The FCC Wants You to Know	9
Playing the Prerecorded Tunes	4	Special Features	7	Chord Charts	10
Playing Back a Prerecorded Tune	4	Recording	7	Specifications	11
Using DEMO	4	Using One-Touch Setting	7		
Using the Preset Tones	4	Using Sustain	7		
Selecting/Playing a Preset Tone	4	Percussion Pads	7		

! IMPORTANT !

If an icon appears at the end of a paragraph, go to the box on that page with the corresponding icon for pertinent information.

⚠ — Warning ! — Important ⚡ — Caution 💡 — Hint 📌 — Note



RadioShack®

www.radioshack.com™

© 2002 RadioShack Corporation.
All Rights Reserved.
RadioShack and RadioShack.com are trademarks
used by RadioShack Corporation.

INTRODUCTION

Thank you for purchasing a RadioShack MIDI Keyboard. Your keyboard is state-of-the-art with many exciting features. You can set the keyboard to sound like 50 different musical instruments. To accompany your music, the keyboard has 30 rhythms, as well as auto accompaniments and percussion sounds.

Your keyboard also includes a MIDI (Musical Instrument Digital Interface) OUT feature, which lets you connect it to other MIDI-equipped musical instruments or devices — even your personal computer. 

CONNECTING POWER

You can power your keyboard with:

- internal batteries
- standard AC power using an optional AC adapter
- a vehicle's cigarette-lighter socket using an optional DC adapter

USING BATTERIES

Your keyboard can use six C batteries (not supplied) for power. For the best performance and longest life, we recommend RadioShack alkaline batteries. 

1. Slide **POWER** to **OFF**.
2. Press the tabs on the battery compartment cover on the bottom of the keyboard and pull up the cover to remove it.
3. Place the batteries in the compartment as indicated by the polarity symbols (+ and -) marked inside the compartment.
4. Replace the cover.

When the keyboard stops operating properly, replace the batteries. 

USING AC OR DC POWER

To power the keyboard from an AC outlet or your vehicle's battery power, you need an AC or DC adapter and a size M Adaptaplug™ (neither supplied, available at your local RadioShack store or online at www.RadioShack.com). 

1. Slide **POWER** to **OFF**.
2. If necessary, set the AC or DC adapter's voltage switch to 9V.
3. Attach the Adaptaplug to the adapter's cord with the tip set to positive (+).

4. Connect the AC or DC adapter's barrel plug to the **DC 9V** jack on the back of the keyboard.

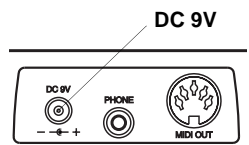

5. Plug the other end of the adapter into the power source.

CONNECTING HEADPHONES

To listen to your keyboard without disturbing others, you can connect an optional pair of stereo headphones with a 1/8-inch (3.5-mm) plug. Your local RadioShack store sells a wide selection of headphones.

Insert the headphones' plug into the **PHONE** jack on the back of the keyboard. 

LISTENING SAFELY

To protect your hearing, follow these guidelines when you use headphones.

- Set the volume to the lowest setting before you begin listening. After you begin listening, adjust the volume to a comfortable level.
- Do not listen at extremely high volume levels. Extended high-volume listening can lead to permanent hearing loss.
- Once you set the volume, do not increase it. Over time, your ears adapt to the volume level, so a volume level that does not cause discomfort might still damage your hearing.

CONNECTING AN EXTERNAL AMPLIFIER

To amplify your keyboard's sound, you can connect it to an optional external amplifier using an audio cable with a 1/8-inch (3.5-mm) plug (not supplied).

To connect an external amplifier to your keyboard, insert the cable's plug into the **PHONE** jack on the back of the keyboard, and connect the cable's other end to the amplifier's input jack(s) (such as AUX IN or TAPE IN).

RadioShack sells a full line of amplifiers, speakers, and connection cables.

NOTE

Introduction

This Owner's Manual explains how to use this electronic keyboard. It does not teach music.

Connecting Power

- Connecting an AC or DC adapter automatically disconnects internal batteries.
- Always disconnect the AC or DC adapter when you finish using the keyboard.

Connecting Headphones

Connecting headphones disconnects the keyboard's built-in speakers.

CAUTION

Using Batteries

- Use only fresh batteries of the required size and recommended type.
- Do not mix old and new batteries, different types of batteries (standard, alkaline, or rechargeable), or rechargeable batteries of different capacities.
- If you do not plan to use the keyboard with batteries for a week or more, remove the batteries. Batteries can leak chemicals that can destroy electronic parts.

Using AC or DC Power

- You must use a (Class 2 for AC) power source that supplies 9V DC and delivers at least 300 mA. Its center tip must be set to positive and its plug must fit the keyboard's **DC 9V** jack. Using an adapter that does not meet these specifications could damage the keyboard or the adapter. 
- Always connect the adapter to the keyboard before you plug it into the power source and unplug the adapter from the power source before you unplug it from the keyboard.

WARNING

Dispose of old batteries promptly and properly. Do not burn or bury them.

A QUICK LOOK AT YOUR KEYBOARD

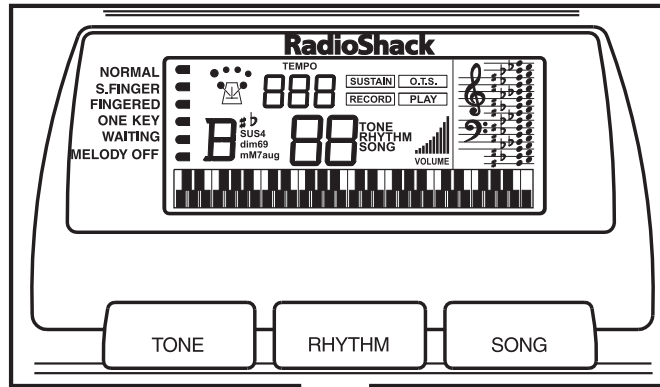

POWER

Speaker

Speaker

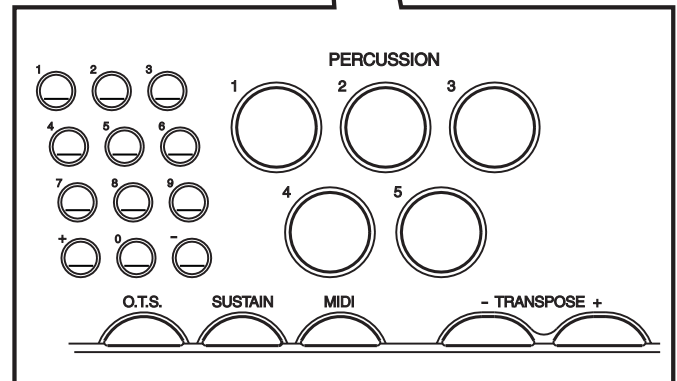
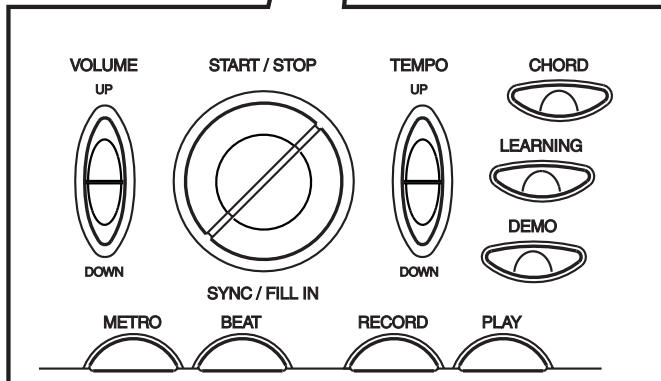
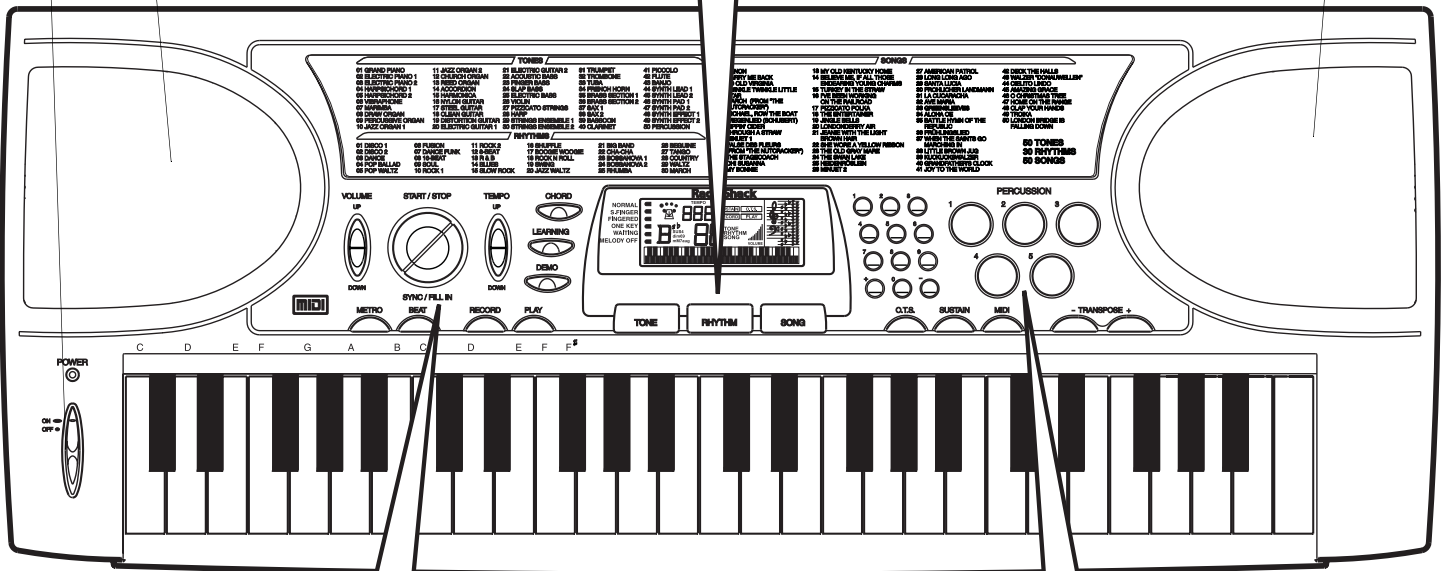

! IMPORTANT !

To prevent hearing damage, always set the keyboard's volume to its lowest level before you begin playing it after changing any settings.

NOTE

Basic Operation

- To remind you to save power during operation, the keyboard automatically sounds a tone about every 5 minutes if you do not press a key.
- The keyboard automatically selects the tone Grand PIANO (No. 01) when you turn the power on. To select a different tone, see "Selecting/Playing a Preset Tone" on Page 4.
- To select an auto-rhythm, see "Using the Preset Auto-Rhythms" on Page 4.
- To play auto accompaniment, see "Using Auto Accompaniment" on Page 5.
- The keyboard's volume ranges from 0 (no sound) to 10 (maximum), and the current volume level appears on the display. Each time you turn on the keyboard, the volume is set to 6.
- To quickly return to the default volume setting of 6, turn the keyboard off then back on.

Playing Back a Prerecorded Tune

- The keyboard always selects the tune "Canon" (No. 01) each time you turn it on.
- Precede a single-digit number with a 0. For example, to select 06 ("Wiegenlied (Schubert)"), press **0 6**.
- If you enter an incorrect first digit, repeatedly press **+** or **-** to move to the next higher or lower numbered tune.
- Each tune plays a different preset tone for the melody.

Using the Preset Tones

The keyboard has 8-note (maximum) polyphonic sound. This means that you can play up to 8 different notes at the same time with most of the keyboard's preset tones.

Selecting/Playing a Preset Tone

- Each time you turn the keyboard on, it automatically selects the tone Grand PIANO (No. 01).
- Precede a single-digit number with a 0. For example, to select VIBRAPHONE (No. 06), press **0 6**.

Selecting/Playing an Auto-Rhythm

- Each time you turn on the keyboard, it automatically selects the rhythm Disco 1 (No. 01).
- Precede a single-digit number with a 0. For example, press **0 5** to select POP WALTZ

OPERATION

BASIC OPERATION

1. To turn on the keyboard, set **POWER** to **ON**. The **POWER** indicator lights. !
2. To hear a sample of the keyboard's many sounds, play a prerecorded tune (see "Playing the Prerecorded Tunes" on Page 4). To make your own music, simply begin playing the keyboard.
3. Repeatedly press **VOLUME UP** or **VOLUME DOWN** to increase or decrease the volume.
4. To turn off the keyboard, set **POWER** to **OFF**. The **POWER** indicator turns off.

PLAYING THE PRERECORDED TUNES

You can listen to any of the 50 tunes that come prerecorded in the keyboard, or you can turn off a tune's melody or accompaniment and then play along on the keyboard.

Playing Back a Prerecorded Tune

1. Press **SONG**, **SONG** and the number of the current tune appears.
2. Choose a tune from the **SONGS** list and enter its two-digit number on the keypad.
Or, you can press **+** or **-** to move to the next higher or lower numbered tune.
3. Press **START/STOP** to start playing the tune.

You can change the tune by repeating Step 2 even while a tune is playing. The new tune immediately begins to play. As it plays, the display shows:

- a "score" to indicate the notes that are playing (right side of the display)
 - a "keyboard" to indicate the fingering and which keys are pressed (bottom of the display)
 - the black dots above the metronome show the beat count in the measure
 - the chord name (center left of the display)
4. Use **VOLUME** to adjust the volume as desired.
 5. To change the tempo, repeatedly press **TEMPO UP** or **TEMPO DOWN**. The current tempo setting appears.
 6. To select a different tune, repeat Step 2. To stop the tune completely, press **START/STOP**.

Using DEMO

To play the prerecorded tunes one by one (in order from the selected starting point), press **DEMO**. To stop the demo, press **DEMO** again.

USING THE PRESET TONES

Your keyboard can sound like 50 different musical instruments. The name and two-digit number for each preset tone is listed on the **TONES** list on the keyboard's top panel.

Selecting/Playing a Preset Tone

1. Press **TONE**, **TONE** and the current tone's number appears.
2. To play a different tone, choose a preset tone from the **TONES** list and enter its two-digit number on the keypad. As you press the keys, the selected digits appear.
Or, you can use **+** or **-** to move to the next higher or lower numbered tone.
3. Play the keyboard to hear the selected tone and adjust **VOLUME UP** or **VOLUME DOWN** to the desired level.
4. To select a different tone, repeat Steps 1 and 2.

USING THE PRESET AUTO-RHYTHMS

Your keyboard has 30 preset auto-rhythms that provide a steady beat for your music. The name and two-digit number of each preset auto-rhythm is listed on the **RHYTHMS** list on the keyboard's top panel.

You can play a preset auto-rhythm on the keyboard in any of the following ways:

- select and play a rhythm (see "Selecting/Playing an Auto-Rhythm")
- synchronize the start of a rhythm with your music (see "Using SYNC" on Page 5)
- briefly vary the pattern of a rhythm (see "Using FILL-IN" on Page 5)

Selecting/Playing an Auto-Rhythm

1. Press **RHYTHM**.
2. To select a different rhythm, choose an auto-rhythm from the **RHYTHMS** list and enter its two-digit number on the keypad. Or, repeatedly press **+** or **-** to move to the next higher or lower numbered rhythm.
3. Press **START/STOP** to start the selected auto-rhythm.
4. Adjust **VOLUME** to the desired level.

5. To change the tempo, repeatedly press **TEMPO UP** or **TEMPO DOWN**. The current tempo setting appears. ↕
6. Play the keyboard along with the auto-rhythm.
7. To select a different rhythm, repeat Steps 1 and 2.
8. To stop the auto-rhythm, press **START/STOP** again.

Using SYNC

This feature lets you synchronize the start of an auto-rhythm with the beginning of your music.

After you select and enter an auto-rhythm, press **SYNC/FILL-IN**. The black dots above the metronome flash to show the keyboard is in a standby mode.

Begin playing the keyboard. The keyboard automatically begins to play the rhythm when you press any key.

Using FILL-IN

This feature lets you insert a short (1- to 2-measure) variation in the beat pattern of a selected auto-rhythm.

Simply press **SYNC/FILL-IN** while the auto-rhythm is playing. The keyboard inserts a variation, then the original rhythm automatically resumes at the end of the current measure. Or, to insert a longer variation, hold down **SYNC/FILL-IN**. The keyboard plays the variation until you release **SYNC/FILL-IN**.

USING AUTO ACCOMPANIMENT

The 19 keys on the left side of the keyboard with note labels above them are called *accompaniment keys*. The accompaniment keys you press determine the type of chord that plays. ↕

You can set the keyboard to play with no accompaniment or two different types of auto accompaniment using the accompaniment keys.

- **NORMAL** — Normal mode. Chords are turned off in this mode (but you can select tone and rhythm).
- **S.FINGER** — Single Fingering mode. This mode lets you play chords on the accompaniment keys using standard chord formations (see “Single Fingering”).
- **FINGERED** — Standard Fingering mode. This mode lets you play chords on the accompaniment keys using chord formations of from three or more notes. The chord name appears on the display.

The number of keys you press determines the type of chord that plays (see “Standard Fingering” on Page 6).

Your keyboard defaults to the Normal mode. Follow the steps under “Single Fingering” or “Standard Fingering” to set it to an accompaniment mode.

Single Fingering

1. Set **POWER** to **ON**.
2. Repeatedly press **CHORD** until a black dot appears next to **S.FINGER** on the left side of the display.
3. Press **RHYTHM**.
4. Enter a two-digit auto-rhythm number.
5. To start the auto-rhythm before the auto accompaniment, press **START/STOP**.

Or, to synchronize the start of the selected auto-rhythm with your accompaniment, press **SYNC/FILL-IN**.
6. Begin the accompaniment at the desired interval by pressing the desired accompaniment key(s).

To play a melody along with the accompaniment, press any key(s) to the right of the accompaniment keys.
7. Adjust **TEMPO** and **VOLUME** to the desired levels.
8. To change chords without interrupting the rhythm, simply press the auto accompaniment key(s) required to form the new chord. The name of the chord appears.
9. To stop auto accompaniment but not the auto-rhythm, repeatedly press **CHORD** until the black dot appears next to **NORMAL** on the display. Or, to stop auto accompaniment and the auto-rhythm, press **START/STOP**.

NOTE

Selecting/Playing an Auto-Rhythm

- You can adjust the tempo to play an auto-rhythm from 40 to 240 beats per minute.
- To reset the tempo to its default (original) speed, press **TEMPO UP** and **TEMPO DOWN** at the same time.

Using Auto Accompaniment

See “Chord Charts” on Page 10 for a list of all the chords you can play on your keyboard.

NOTE

- You do not have to press the key marked with parentheses on the keyboard in the chart to produce a 7, m7, M7, mM7, add9, or madd9 chord.
- Although the chart shows only one possible fingering position for each chord, it is possible to play a chord using several different positions. For example, the following three positions produce the same C chord.



- When you play an aug, 7^{b5}, or dim7 chord, the lowest note you play determines the root of the chord. Be sure that your fingering correctly defines the root you want.

Standard Fingering

The standard fingering method uses standard formations of three or more notes, and lets the experienced musician play a wider variety of accompaniment chords.

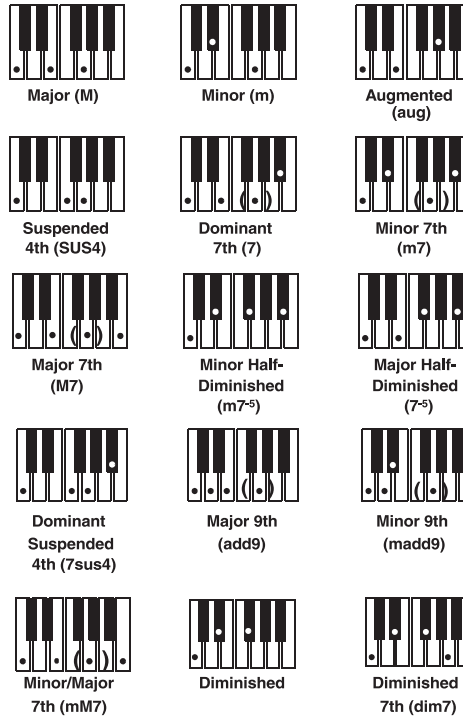

- Set **POWER** to **ON**.
- Repeatedly press **CHORD** until a black dot appears next to **FINGERED** on the left side of the display.
- Select and enter an auto-rhythm.
- To start the auto-rhythm before your auto accompaniment, press **START/STOP**.

Or, to synchronize the start of the selected auto-rhythm with your accompaniment, press **SYNC/FILL-IN**.

- Begin the accompaniment at the desired interval by pressing at least three accompaniment keys to play the desired chord.

To play a melody along with the accompaniment, press any key(s) to the right of the accompaniment keys.

- Adjust **TEMPO** and **VOLUME** to the desired levels.
- To change chords without interrupting the rhythm, simply press the auto accompaniment key(s) required to form the new chord. The name of the chord appears.
- To stop auto accompaniment and the auto-rhythm, press **START/STOP**.

LEARNING TO PLAY

Your keyboard's learning feature lets beginning keyboard players easily learn and play a prerecorded tune. You can select any of the following modes:

- ONE KEY** — in this mode, press **START/STOP** and any key to play accompaniment and a melody note. The note appears.
- WAITING** — In this mode, the melody does not play until you play a correct note. The next note of the tune appears.
- MELODY OFF** — in this mode, you can play melody with accompaniment.

To play prerecorded tunes:

- Press **SONG**, then repeatedly press **LEARNING** until black dots appear next to **ONE KEY** on the left side of the display.

- Select a tone from the **SONGS** list and enter its two-digit number on the keypad.

Or, you can press **-** or **+** to move to the next higher or lower numbered tune.

- Press **START/STOP**. The keyboard plays the first note of the tune you selected and the note appears. Press the corresponding key on the keyboard to continue learning. The next note you need to press appears. The tune will continue to play even if you press the wrong key.
- To stop learning, press **START/STOP** again or press **LEARNING**. If you pressed **LEARNING**, a black dot appears next to **WAITING** and a note appears. Press the correct key to continue learning. The tune doesn't play until you press the correct key.

If you want to play the tune with accompaniment in the learning mode, repeatedly press **LEARNING** until a black dot appears next to **MELODY OFF**.

If you want to quit the learning mode, repeatedly press **LEARNING** until the black dot appears next to **NORMAL**.

USING THE METRONOME

To turn on the keyboard's metronome, press **TONE** or **RHYTHM**, then press **METRO**. The metronome's bar swings along with the tempo you selected, and the corresponding beat appears. Press **METRO** again to turn the metronome off.

USING BEAT

When the metronome is on, repeatedly press **BEAT** until you hear the desired beat to adjust it. 9 beats (00, 02–09) are available and can be selected cyclically. The beat number you selected appears. ✓

SPECIAL FEATURES

RECORDING

You can record a sequence of notes up to 37 notes in length.

1. Press **RECORD** to start recording. **RECORD** appears.
2. Play the notes you want to record.
3. Press **PLAY** to play the notes you recorded. **PLAY** appears.
4. To turn off recording, press **RHYTHM**, **TONE**, or **SONG**. ✓

USING ONE-TOUCH SETTING

Your keyboard's One-Touch Setting (O.T.S.) feature lets you automatically play a preset tone to match a selected auto-rhythm you changed.

1. Press **RHYTHM**.
2. Enter a two-digit auto-rhythm number.
3. Press **O.T.S.**. **O.T.S.** appears.
4. Press **TONE**. The preset tone that matches the selected auto-rhythm appears.

To exit One-Touch Setting, press **O.T.S.**. **O.T.S.** disappears.

USING SUSTAIN

For added flexibility and control as you make music, you can set the keyboard so it sustains sound.

1. Press **SUSTAIN**. **SUSTAIN** appears. The keyboard sustains the notes you play.
2. Press **SUSTAIN** again to turn off sustain.

PERCUSSION PADS

USING A PERCUSSION PAD

Your keyboard's percussion pads put the sound of 5 different percussion instruments (bass drum, snare drum, hi-hat open, high tom-tom, and hi-hat close) at your fingertips.

To play a percussion pad sound, simply press the desired pad at any time. The keyboard plays the selected percussion sound once each time you press the pad.

Recording/Playing a Percussion Pad Sound

You can record any of the available percussion sounds onto any of the percussion pads. This lets you quickly select and play any percussion sound that the keyboard can make. ✓

1. Press **TONE** then enter **5 0** on the keyboard.
2. Select the tone you want by pressing any of the 16 white keys in the middle of the keyboard until you hear the sound you want.
3. When you hear the tone you want to record, hold down the percussion pad you want to assign the sound to and press the white key.

TRANSPOSING

The keyboard automatically selects the key of middle C each time you turn it on. For added flexibility, you can transpose (change) the keyboard's key using as many as 12 steps (+6 to -6). You can adjust the transposition freely by pressing the **TRANPOSE** buttons.

To transpose the keyboard's key, press **TRANPOSE +** to raise a chromatic scale or **TRANPOSE -** to decrease a chromatic.

To reset the keyboard's key to its default, press **TRANPOSE +** and **TRANPOSE -** at the same time.

NOTE

Using BEAT

The higher the beat number, the faster the beat.

Recording

If the keyboard loses power, recording is turned off and any recording you made is erased.

Recording/Playing a Percussion Pad Sound

The keyboard clears any sound you assign to a percussion pad each time you turn it off.

CAUTION

- Always turn off power to your keyboard and the other MIDI device before you connect or disconnect MIDI cables.
- As you make the cable connections, be sure to align the MIDI cable pins with the matching holes on your keyboard's **MIDI OUT** terminal. If you have trouble plugging in the cable, do not force it! You might damage the plug or the instrument.

NOTE

- Connecting your keyboard to another MIDI device requires a MIDI cable (not supplied). See "Making the MIDI Connections".
- The keyboard's auto-rhythms, prerecorded tunes, sustain information, and transpose information cannot be sent as MIDI data.
- If you send MIDI data to a device such as a personal computer, the computer will need a sound card, software to interpret the data, and a pair of speakers (none supplied). RadioShack carries sound cards, MIDI cable, speakers, and software.
- MIDI Channel 10 is preset to percussion data in some MIDI receiving devices, depending on the specific device you select.

USING MIDI

Your keyboard includes a feature called MIDI (Musical Instrument Digital Interface). MIDI is the universal standard for sending and receiving performance data between all types of electronic musical instruments, regardless of the manufacturer.

Using MIDI, you can play music on your keyboard and another instrument at the same time while pressing the keys on only one, record your music to a sequencer, acquire a wider selection of preset tones from a sound module, and much more.

ABOUT MIDI

Every MIDI-equipped instrument has a MIDI OUT terminal, and some also have a MIDI IN and MIDI THRU terminal. Each of these terminals serves a different purpose.

- MIDI OUT sends MIDI data to ("talks to") the other MIDI instrument(s).
- MIDI IN receives ("listens to") MIDI data sent by the other MIDI instrument(s).
- MIDI THRU lets you connect ("network") additional MIDI instruments, and sends along to other MIDI devices a copy of all data it receives through its MIDI IN terminal.

Your keyboard has a **MIDI OUT** terminal.

The cable that connects MIDI devices does not actually carry sound between them, like a speaker wire carries sound from a receiver to a speaker. Instead, MIDI-equipped devices communicate with each other using digital codes (instructions). One MIDI device sends digital instructions representing exactly what is being played on it. The other MIDI device receives and translates those instructions, then produces (or records) the sound as it was played on the first device. 

MAKING THE MIDI CONNECTIONS

To connect your keyboard to another MIDI-equipped device, you must use a MIDI cable (available at your local RadioShack store). The keyboard's MIDI data is sent automatically as you play. 

1. Use a MIDI cable to connect **MIDI OUT** on the back of the keyboard to the other device's MIDI IN terminal.
2. Repeatedly press **MIDI** to select a MIDI channel. MIDI uses up to 16 channels to exchange data. As in a TV broadcast, different channels send different data.
3. To transmit to the MIDI device, play the melody using the keyboard's black and white keys.

TROUBLESHOOTING

If your keyboard is not performing as it should, these suggestions might help. If you still cannot solve the problem, take the keyboard to your local RadioShack store for assistance.

Trouble	Possible Cause	Remedy
No sound, even when the keys are pressed.	POWER is set to OFF .	Set POWER to ON .
	Volume is turned down.	Repeatedly press VOLUME UP to increase the volume.
	Headphones are connected.	Disconnect headphones.
	Power supply problem.	Check the power supply. Are battery contacts (+/-) facing correctly? Are the batteries fresh? Is the AC or DC adapter connected properly?
No rhythm.	Volume is turned down.	Repeatedly press VOLUME UP to increase the volume.
	Rhythm is not started.	Press START/STOP .
No accompaniment when accompaniment keys are pressed.	Volume is turned down.	Repeatedly press VOLUME UP to increase the volume.
	Accompaniment keys are not pressed.	Press the accompaniment keys (on the left side of the keyboard).
No sound when connected to an external amplifier.	Volume is turned down.	Repeatedly press VOLUME UP to increase the volume.
	Defective connection cord.	Replace the connection cord.
	Problem with external amplifier.	Check the amplifier.
No sound when playing MIDI data.	MIDI cables are not connected properly.	Check the connection.

CARE

Keep the keyboard dry; if it gets wet, wipe it dry immediately. Use and store the keyboard only in normal temperature environments. Handle the keyboard carefully; do not drop it. Keep the keyboard away from dust and dirt, and wipe it with a soft cloth occasionally to keep it looking new.

SERVICE AND REPAIR

If your keyboard is not performing as it should, take it to your local RadioShack store for assistance. Modifying or tampering with the keyboard's internal components can cause a malfunction and might invalidate its warranty and void your FCC authorization to operate it.

THE FCC WANTS YOU TO KNOW

This equipment complies with the limits for a Class B digital device as specified in Part 15 of *FCC Rules*. These limits provide reasonable protection against radio and TV interference in a residential area. However, your equipment might cause TV or radio interference even when it is operating properly. To eliminate interference, you can try one or more of the following corrective measures:

















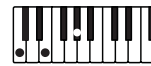



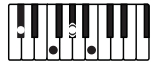
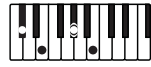

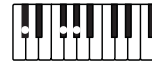







































































- reorient or relocate the receiving antenna
- increase the distance between the equipment and the radio or TV
- use outlets on different electrical circuits for the keyboard and the radio or TV.

Consult your local RadioShack store if the problem still exists.

You must use shielded interface cables with this equipment.

CHORD CHARTS

These tables show the fingering for the chords you play most often.

	Major (C)	Minor (Cm)	Seventh (C7)	Minor Seventh (Cm7)	Major Seventh (CM7)	Suspended fourth (Csus4)	Augmented (Caug)	Diminished (Cdim)
C								
C#								
D								
E ^b								
E								
F								
F#								
G								
A ^b								
A								
B ^b								
B								

	Diminished Seventh (Cdim7)	Major Sixth (C6)	Minor Sixth (Cm6)	7th Suspended fourth (C7sus4)	Major ninth (CM79)	Seventh ninth (C79)	Augmented Seventh (C7aug)
C							
C#							
D							
Eb							
E							
F							
F#							
G							
Ab							
A							
Bb							
B							

SPECIFICATIONS

Number of Keys	49
Polyphonic Sound	8-note (Max.)
Preset Tones	50
Auto-Rhythms	30
Prerecorded Tunes	50 Tunes
Effect	Transpose
Rhythm Controls	TEMPO, FILL-IN, START/STOP
Built-In Speakers	4 Inches (102 mm) x 2 (Output 3W Max Each)
Terminals:	
Power Supply	DC 9V Jack
PHONE Jack	1/8 Inches (3.5 mm)
MIDI OUT Jack	OUT
Power Sources	DC: 6 C batteries; AC: 120V, 60Hz, with AC adapter; Vehicle Battery: 9V with DC adapter
Dimensions (HWD)	2 ¹⁵ / ₁₆ x 26 ¹⁵ / ₁₆ x 10 ⁹ / ₁₆ Inches (75 x 684 x 269 mm)
Weight (Without Batteries)	5 lb 8 oz (2.5 kg)
Included Accessory	Play Guide for the Prerecorded Tunes

Specifications are typical; individual units might vary. Specifications are subject to change and improvement without notice.

Limited One-Year Warranty

This product is warranted by RadioShack against manufacturing defects in material and workmanship under normal use for one (1) year from the date of purchase from RadioShack company-owned stores and authorized RadioShack franchisees and dealers. EXCEPT AS PROVIDED HEREIN, RadioShack MAKES NO EXPRESS WARRANTIES AND ANY IMPLIED WARRANTIES, INCLUDING THOSE OF MERCHANTABILITY AND FITNESS FOR A PARTICULAR PURPOSE, ARE LIMITED IN DURATION TO THE DURATION OF THE WRITTEN LIMITED WARRANTIES CONTAINED HEREIN. EXCEPT AS PROVIDED HEREIN, RadioShack SHALL HAVE NO LIABILITY OR RESPONSIBILITY TO CUSTOMER OR ANY OTHER PERSON OR ENTITY WITH RESPECT TO ANY LIABILITY, LOSS OR DAMAGE CAUSED DIRECTLY OR INDIRECTLY BY USE OR PERFORMANCE OF THE PRODUCT OR ARISING OUT OF ANY BREACH OF THIS WARRANTY, INCLUDING, BUT NOT LIMITED TO, ANY DAMAGES RESULTING FROM INCONVENIENCE, LOSS OF TIME, DATA, PROPERTY, REVENUE, OR PROFIT OR ANY INDIRECT, SPECIAL, INCIDENTAL, OR CONSEQUENTIAL DAMAGES, EVEN IF RadioShack HAS BEEN ADVISED OF THE POSSIBILITY OF SUCH DAMAGES.

Some states do not allow limitations on how long an implied warranty lasts or the exclusion or limitation of incidental or consequential damages, so the above limitations or exclusions may not apply to you.

In the event of a product defect during the warranty period, take the product and the RadioShack sales receipt as proof of purchase date to any RadioShack store. RadioShack will, at its option, unless otherwise provided by law: (a) correct the defect by product repair without charge for parts and labor; (b) replace the product with one of the same or similar design; or (c) refund the purchase price. All replaced parts and products, and products on which a refund is made, become the property of RadioShack. New or reconditioned parts and products may be used in the performance of warranty service. Repaired or replaced parts and products are warranted for the remainder of the original warranty period. You will be charged for repair or replacement of the product made after the expiration of the warranty period.

This warranty does not cover: (a) damage or failure caused by or attributable to acts of God, abuse, accident, misuse, improper or abnormal usage, failure to follow instructions, improper installation or maintenance, alteration, lightning or other incidence of excess voltage or current; (b) any repairs other than those provided by a RadioShack Authorized Service Facility; (c) consumables such as fuses or batteries; (d) cosmetic damage; (e) transportation, shipping or insurance costs; or (f) costs of product removal, installation, set-up service adjustment or reinstallation.

This warranty gives you specific legal rights, and you may also have other rights which vary from state to state.

RadioShack Customer Relations, 200 Taylor Street, 6th Floor, Fort Worth, TX 76102

12/99

Free Manuals Download Website

<http://myh66.com>

<http://usermanuals.us>

<http://www.somanuals.com>

<http://www.4manuals.cc>

<http://www.manual-lib.com>

<http://www.404manual.com>

<http://www.luxmanual.com>

<http://aubethermostatmanual.com>

Golf course search by state

<http://golfingnear.com>

Email search by domain

<http://emailbydomain.com>

Auto manuals search

<http://auto.somanuals.com>

TV manuals search

<http://tv.somanuals.com>