

ENFORCER[®]

SK-910RC4Q

Central Receiver

Manual



- 4 Channels
- 4 Channel relay outputs
- 1 Auxiliary relay output (12VDC)
- 4 Relay output modes
- 4 Programmable alert tones
- Up to 500' (152m) range

SLI[®] SECO-LARM[®]



Note: Model numbers that end with "Q" or that have a round green "Q" sticker signify RoHS-compliant products.
Download from www.Somanuals.com. All Manuals Search And Download.

Table of Contents:

Introduction	2	Alert Tones	4
Specifications	2	Programming Each Channel Output.....	5
Dimensions	2	Setting the Timed Output.....	6
Overview.....	3	Setting the Auxiliary Relay.....	6
Installation Notes	3	Setting the Power LED	7
Code Learning a New Transmitter.....	4	Sample Applications	7
Displaying or Clearing a Channel's Memory ..	4	Troubleshooting.....	8

Introduction:

The SK-910RC4Q Central Receiver is a four-channel receiver with four independently controlled output modes and a unique volume-adjustable alert tone for each channel. This RF receiver is compatible with all ENFORCER transmitters, both code hopping and fixed code. The receiver can be used to remotely control a variety of home automation devices, such as garage door openers, lights, motorized gates, lifts, and other devices.

Specifications:

Operating voltage		12VDC	RF frequency	315MHz
Current draw	Standby	15mA@12VDC	# of RF channels	4
	1 Relay active	85mA@12VDC	Alert sound	100 +/- 3dB@10cm adjustable
	2 Relays active	140mA@12VDC	Number of alert tones	4, programmable
	3 Relays active	210mA@12VDC	Connectors	14-Pin terminal block, 3 pins per relay, 2-pin auxiliary output
	4 Relays active	260mA@12VDC	Dimensions	5 ⁵ / ₁₆ "x 3 ³ / ₁₆ "x1" (135x83x26 mm)
	All relays active	330mA@12VDC	Operating temperature	-40°~167° F (-40°~75° C)
	All relays + sound	450mA@12VDC	Range	Up to 500' (152m) ²
DC power supply		500mA@12VDC (included)	² Actual range will vary greatly depending on the operating environment.	
Relay type		Form C (NO/NC/COM)		
Channels 1~4 relay rating		10A@12VDC		
Auxiliary relay rating		3A max. ¹		

¹Included power supply will not support loads larger than 500mA. For larger loads, replace with appropriate DC power supply.

Dimensions:

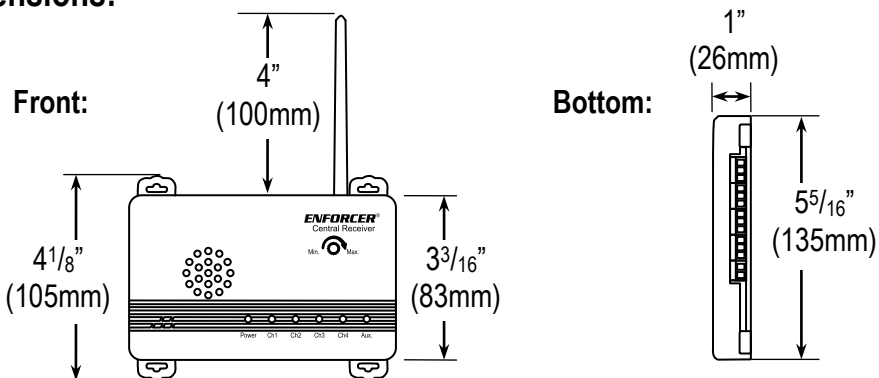

Overview:

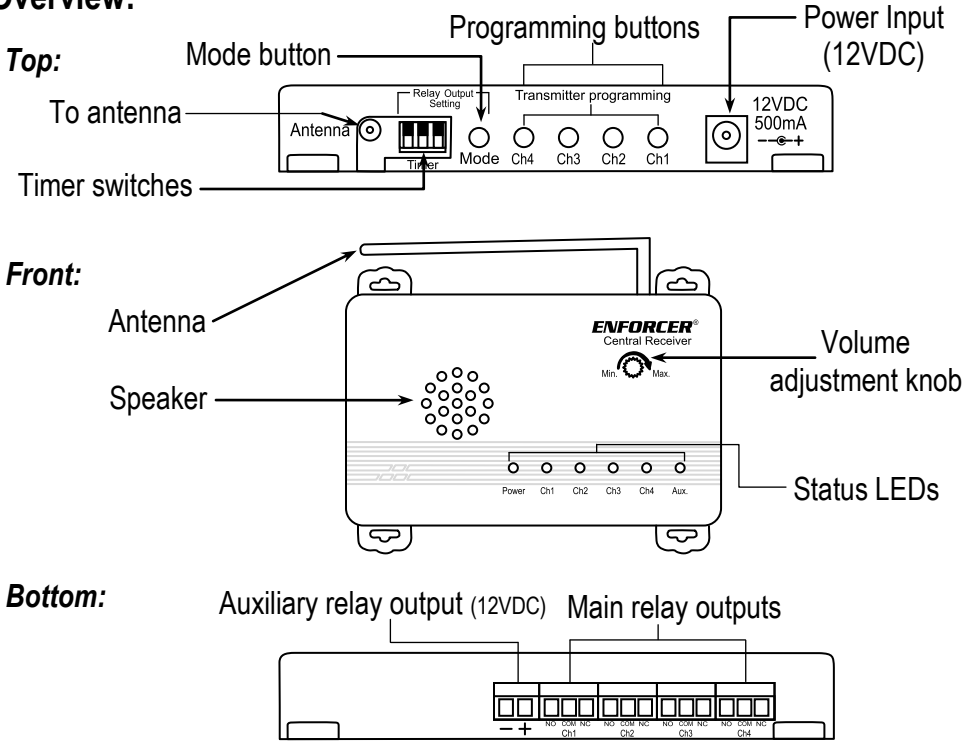

Installation Notes:

1. Mount in a convenient location where alert tones and LED indicators will be audible/visible.
2. Do not install in a location surrounded by metal as RF signals may be blocked, decreasing range.
3. Do not install in a location exposed to weather, moisture or high humidity.

To open the housing:

1. Remove the antenna by unscrewing the antenna base counterclockwise.
2. Remove the bottom cover starting from point 1 shown in the diagram. Follow with points 2 and 3.

NOTE: Applying outward pressure on the clip points will help release the bottom cover.

3. Before attempting to release point 4, gently slide the bottom cover down and left to bring the programming buttons out of their holes in the housing.
4. Disconnect the speaker plug from the PCB to avoid damage while working with the cover off.

5. When replacing the bottom cover, ensure the speaker wires are not caught between the speaker and the PCB. Check that buttons and knobs are properly inserted in their openings in the housing.

NOTE: Buttons and knobs are connected directly to the PCB.

Be gentle to avoid damaging delicate electronics. Do not force the cover on or off if resistance is felt.

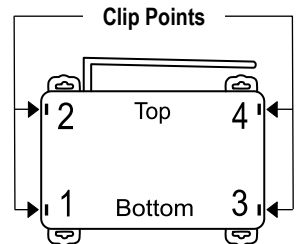

Code Learning a New Transmitter:

Each receiver channel can learn the codes of up to 15 different transmitters. Transmitters are learned on a first-in, first-out basis. (For example, if 15 transmitter codes have been learned, when a new transmitter is learned the first of the 15 codes that were learned before will be deleted.)

1. To learn a new transmitter, first press and hold the programming button of the channel to be programmed for 3 seconds or more. (Programming buttons are found on the top of the unit.)
Note: A pencil or other pointed object may be necessary to press the programming buttons.
2. The channel's red LED will flash quickly to indicate it is in Learning Mode. **DO NOT REPEAT STEP 1 WHILE THE LED IS FLASHING OR CHANNEL MEMORY WILL BE CLEARED.**
3. While the channel LED is flashing, press the button of the transmitter being learned one time. The channel's LED will flash once to indicate the transmitter code was successfully learned.
4. If no transmitter is learned within 15 seconds, the receiver will return to standby mode.
5. If the transmitter has been learned already, the channel LED will turn steady ON and the code will not be learned a second time.

Displaying or Clearing a Channel's Memory:

Display Channel Memory:

1. Press a channel's programming button once.
2. The number of flashes is the same as the number of transmitters that channel has learned.

Clear Channel Memory:

1. Hold down the channel's programming button for three seconds.
2. The channel's red LED will start flashing.
3. After the LED has started flashing, hold down the programming button for three more seconds. The LED will flash two more times, indicating that all codes learned by that channel have been cleared.

Alert Tones:

Each channel has a specific alert tone. See the chart on the lower right.

1. Open the housing following the instructions under Installation Notes on page 3 of this manual.
2. Locate the Alert Tones DIP switch marked SW7. Switches marked 1 through 4 determine whether each channel's sound will play when the respective channel is triggered.
3. If the switch is in the ON position, the alert tone will play when the channel is triggered.
4. If the switch is in the OFF position, no alert tone will play when the channel is triggered.
5. Adjust the volume using the volume adjustment knob.

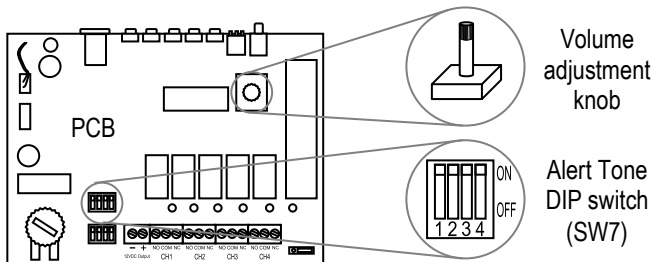

Alert Tones	
Channel 1	Doorbell
Channel 2	Bells
Channel 3	Home Sweet Home
Channel 4	Alarm

Programming Each Channel Output:

- Each channel output can be separately programmed for one of four different modes:

Timed Output: When the channel receives a signal, the relay will turn ON for 1~60 seconds, depending on the output time set.

Note: The timer, once set, is the same length for all outputs programmed for Timed Output. (See page 6 for timer programming.)

Toggle Output: When the channel receives a signal, the relay will turn ON and remain activated until a second signal is received.

Latch Output: When the channel receives a signal, the relay will turn ON. Turn the relay OFF by pressing that channel's programming button on the Central Receiver unit.

Validity Output: When the channel receives a signal, the relay will turn ON for as long as a signal is being received.

- To enter programming mode, press the button marked Mode on the top of the unit. Each channel's red LED will flash a number of times to show the current output mode that it is in:

# of Flashes	Output Mode	# of Flashes	Output Mode
1	Timed Output	3	Latch Output
2	Toggle Output	4	Validity Output

- To change modes, press the desired channel's transmitter programming button. Each press moves to the next mode in the sequence shown in the diagram below. After changing modes, count the number of times the channel LED flashes to verify the channel is in the correct mode.
- When finished, press Mode again to end programming.

Example 1: If the present mode is Timed Output, and the desired mode is Latch Output, press the channel's programming button 2 times.

Example 2: If the present mode is Validity Output and the desired mode is Latch Output, press the channel's programming button 3 times.

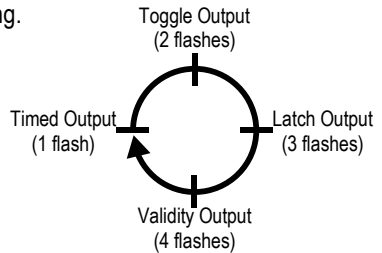

Programming Button Functions (Per Channel)

Learn mode	Press and hold the button for 3 seconds or more to enter Learn mode.
Clear memory	Press and hold the button for 3 seconds or more. When LED starts flashing, press and hold again for 3 seconds to delete all learned codes. LED will flash twice.
Reset Latch Output	If channel is set to Latch Output, press to turn relay off after it has been triggered.
Memory display	Press momentarily. The Channel LED will flash a number of times corresponding to the number of codes stored.

LED Indicator Functions (Per Channel)

Steady ON	Receiving signal from transmitter OR indicates code has already been learned during code learning.
Fast flash	In either code learning OR memory display OR channel output programming mode.
One flash	A transmitter's code was learned OR channel relay is in Timed output mode.
Two flashes	All learned codes were deleted OR channel relay is in Toggle output mode.
Three flashes	Channel relay is in Latch output mode.
Four flashes	Channel relay is in Validity output mode.
0~15 flashes	During normal operation, press the programming button to display the number of codes stored. 1 flash = 1 code stored.

Setting the Timed Output:

When a channel is set to Timed Output, triggering the channel will activate the relay for a set period of time. Factory default is 1 second.

1. The time can be set from 1~60 seconds using the Timer switches on the top of the receiver.
2. Set switches according to the following chart.

NOTE: The time set via the DIP switches applies to all channels programmed for Timed Output.

Sec.	SW1	SW2	SW3
1*	On	Off	Off
2	Off	On	Off
3	Off	Off	On
4	On	Off	On
5	Off	On	On
10	On	On	Off
30	Off	Off	Off
60	On	On	On

*Default setting

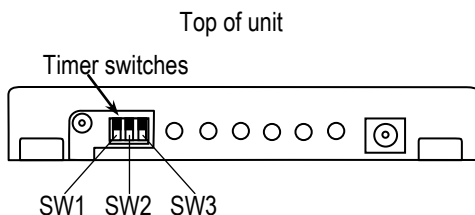

Setting the Auxiliary Relay:

Each channel may be individually set to activate a separately timed 12VDC output programmable from 1 second to 10 minutes. The auxiliary relay provides up to 3A@12VDC*.

1. Connect the auxiliary device to the auxiliary relay. The two auxiliary relay terminals are the left-most terminals on the terminal block as shown in the diagram below.
2. Select which channels will trigger the auxiliary relay using the Auxiliary Relay DIP switch (SW8), located on the PCB as shown in the diagram below.
3. If the switch is in the ON position, triggering the corresponding channel will activate the auxiliary relay.
4. If the switch is in the OFF position, triggering the corresponding channel will not activate the auxiliary relay.

***Note**
Included power supply will not support loads larger than 500mA. For larger loads, replace with appropriate DC power supply.

Setting Auxiliary Relay Timer:

1. Output time can be adjusted from 1 second to 10 minutes using the auxiliary relay output time potentiometer.
2. Turning the potentiometer clockwise will increase the output time.
3. Turning the potentiometer counterclockwise will decrease the output time.

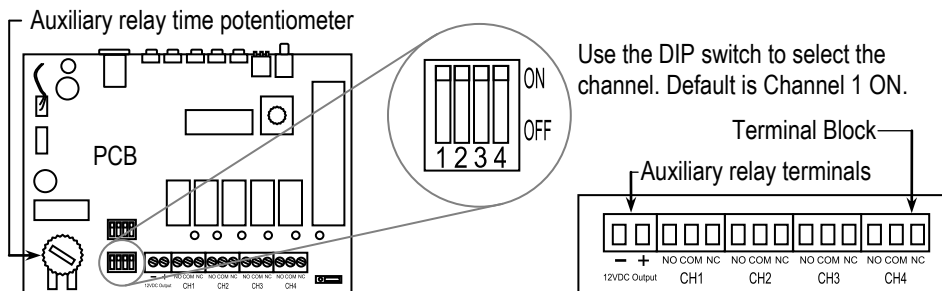

Setting the Power LED:

The power LED can be set to Bright, Dim, or OFF using the power LED jumper.

1. Locate the jumper on the PCB as shown below.
2. Place the jumper on the middle and right pins for Dim, and on the middle and left pins for Bright.
3. Remove the jumper or place on the left or right pin only to set the power LED to OFF.

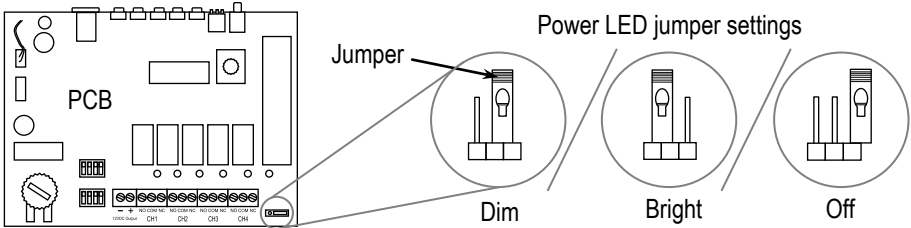

Sample Applications:

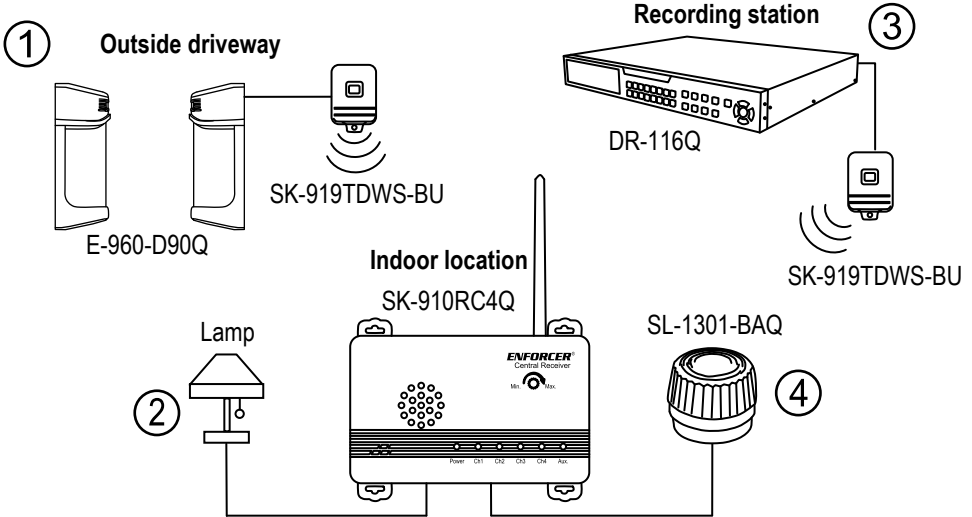

1. A photobeam sensor installed on a driveway (E-960-D90Q or similar) is connected to an RF wired transmitter (SK-919TDWS-BU or similar). When the photobeam sensor is triggered, the transmitter sends a signal to the SK-910RC4Q Central Receiver.
2. Inside, an alarm, lamp, or other signaling device is connected to the channel's relay output. When the intruder triggers the photobeam sensor, an alarm is triggered or the light turns on.
3. Alternatively, a DVR (DR-1 series or similar) can be connected to an RF wired transmitter. When an event (such as motion detection) occurs on the DVR, the transmitter sends a signal to the SK-910RC4Q Central Receiver, alerting the user and activating the channel relay.
4. In addition to connecting a signaling device to the channel relay output, an auxiliary device such as an LED strobe light (SL-1301 series or similar), can be powered by the SK-910RC4Q Central Receiver when a channel is activated.

Troubleshooting:

The SK-910RC4Q will not read a transmitter it has already learned.

- Check that the transmitter is operating within the receiver's range.
- Check number of transmitters learned. Learning more than 15 will cause the first transmitter learned to be deleted.
- Check that there are transmitter codes stored on the channel by pressing that channel's programming button once and counting the flashes.

The SK-910RC4Q is not in the correct relay output mode.

- Programming modes change starting from the current mode. For example, press the programming button 3 times to go from Toggle Output to Timed Output. If necessary, please review **Programming Channel Output** on page 5.

Also Available from SECO-LARM:

Single-Button Transmitter



SK-919TD1S-UP

LED Strobe Light



SL-1301-BAQ Series

Wired RF Transmitter



SK-919TDWS-BU

Desktop Transmitter



SK-919TP2D-P

Dual Photobeam Sensor



E-960-D90Q

Electric Door Strikes



SK-990AQ

WARRANTY This SECO-LARM product is warranted against defects in material and workmanship while used in normal service for a period of one (1) year from the date of sale to the original consumer customer. SECO-LARM's obligation is limited to the repair or replacement of any defective part if the unit is returned, transportation prepaid, to SECO-LARM. This Warranty is void if damage is caused by or attributed to acts of God, physical or electrical misuse or abuse, neglect, repair, or alteration, improper or abnormal usage, or faulty installation, or if for any other reason SECO-LARM determines that such equipment is not operating properly as a result of causes other than defects in material and workmanship. The sole obligation of SECO-LARM, and the purchaser's exclusive remedy, shall be limited to replacement or repair only, at SECO-LARM's option. In no event shall SECO-LARM be liable for any special, collateral, incidental, or consequential personal or property damages of any kind to the purchaser or anyone else.

NOTICE: The information and specifications printed in this manual are current at the time of publication. However, the SECO-LARM policy is one of continual development and improvement. For this reason, SECO-LARM reserves the right to change specifications without notice. SECO-LARM is also not responsible for misprints or typographical errors.

Copyright © 2010 SECO-LARM U.S.A., Inc. All rights reserved. This material may not be reproduced or copied, in whole or in part, without the written permission of SECO-LARM.

SECO-LARM® U.S.A., Inc.

16842 Millikan Avenue, Irvine, CA 92606
Tel: 800-662-0800 / 949-261-2999 Fax: 949-261-7326

Website: www.seco-larm.com
E-mail: sales@seco-larm.com

 PITSW1
MISK-910RC4Q_1007.docx
Order Part# 762-508-1%

Free Manuals Download Website

<http://myh66.com>

<http://usermanuals.us>

<http://www.somanuals.com>

<http://www.4manuals.cc>

<http://www.manual-lib.com>

<http://www.404manual.com>

<http://www.luxmanual.com>

<http://aubethermostatmanual.com>

Golf course search by state

<http://golfingnear.com>

Email search by domain

<http://emailbydomain.com>

Auto manuals search

<http://auto.somanuals.com>

TV manuals search

<http://tv.somanuals.com>