



**21-Inch Walk-Behind Rotary Mowers
SP6211 and SP6213**

OPERATOR'S MANUAL



OMGC00390 K9

North American Version
Litho in U.S.A.

INTRODUCTION

Thank You for Purchasing a Scotts Product

We appreciate your business and wish you many years of safe and satisfied use of your machine.

Using Your Operator's Manual

This manual is an important part of your machine and should remain with the machine when you sell it.

Reading your operator's manual will help you and others avoid personal injury or damage to the machine. Information given in this manual will provide the operator with the safest and most effective use of the machine. Knowing how to operate this machine safely and correctly will allow you to train others who may operate this machine.

Section in your operator's manual are placed in a specific order to help you understand all the safety messages and learn the controls so you can operate this machine safely. You can also use this manual to answer any specific operating or servicing questions. A convenient index located at the end of this book will help you to find needed information quickly.

The machine shown in this manual may differ slightly from your machine, but will be similar enough to help you understand our instructions.

RIGHT-HAND and LEFT-HAND sides are determined by facing in the direction the machine will travel when going forward. When you see a broken line arrow (----->), the item referred to is hidden from view.

Special Messages

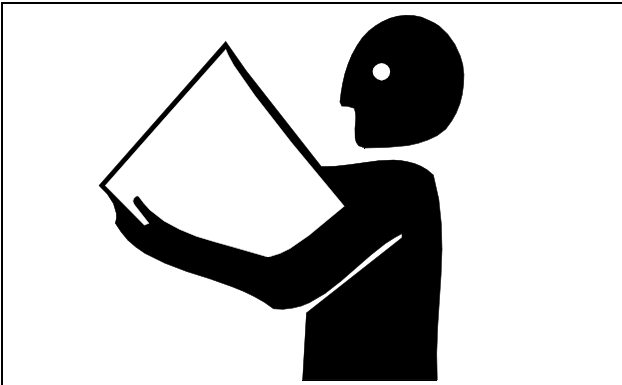

Your manual contains special messages to bring attention to potential safety concerns, machine damage as well as helpful operating and servicing information. Please read all the highlighted information carefully to avoid injury and machine damage.



CAUTION: Avoid injury!

This symbol and text highlight potential hazards or death to the operator or bystanders may occur if the hazards or procedures are ignored.

IMPORTANT: Avoid damage! This text is used to tell the operator of actions or conditions that might result in damage to the machine.

NOTE: General information is given throughout the manual that may help the operator in the operation of the machine.

CALIFORNIA Proposition 65 Warning



Warning: The Engine Exhaust from this product contains chemicals known to the State of California to cause cancer, birth defects or other reproductive harm.

PRODUCT IDENTIFICATION

Record Identification Numbers

If you need to contact an authorized Scotts servicing dealer for information on servicing, always provide the product model and serial number.

You will need to locate the model and serial number for the machine and for the engine of your machine and record the information in the spaces provided below.

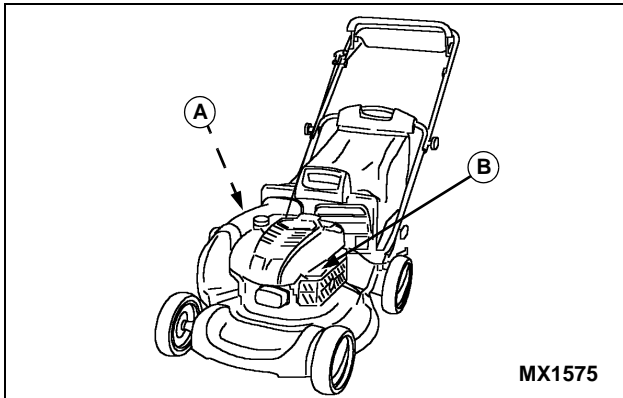

DATE OF PURCHASE:

DEALER NAME:

DEALER PHONE:

PRODUCT IDENTIFICATION NUMBER (A):

ENGINE SERIAL NUMBER (B):

TABLE OF CONTENTS

Contents

| | |
|-------------------------|----|
| Safety | 1 |
| Operating | 5 |
| Replacement Parts | 12 |
| Service Intervals | 13 |
| Service | 14 |
| Troubleshooting | 25 |
| Storing Machine..... | 27 |
| Assembly | 29 |
| Specifications | 33 |
| Warranty | 35 |
| Index | 38 |

All information, illustrations and specifications in this manual are based on the latest information at the time of publication. The right is reserved to make changes at any time without notice.

COPYRIGHT© 1999

Deere & Co.

John Deere Worldwide Commercial and
Consumer Equipment Division

Horicon, WI

All rights reserved

Previous Editions

COPYRIGHT©

OMGC00390 K9 - English

SAFETY

Safety-Alert Symbol



Read and recognize safety information. Be alert to the potential for personal injury when you see this safety-alert symbol.

On your machine safety labels, the words DANGER, WARNING, and CAUTION are used with this safety-alert symbol. DANGER identifies the most serious hazards. In this manual, the word CAUTION and this symbol call attention to safety messages.

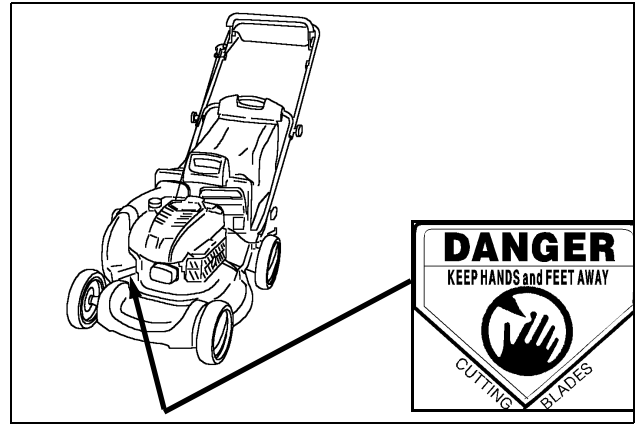

DANGER: KEEP HANDS AND FEET AWAY FROM CUTTING BLADES

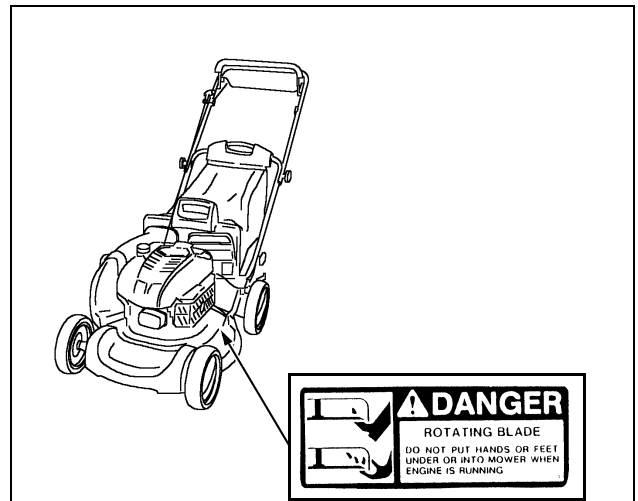

DANGER: ROTATING BLADE

DO NOT PUT HANDS OR FEET UNDER OR INTO MOWER WHEN ENGINE IS RUNNING

Machine Safety Labels



WARNING: AVOID SERIOUS INJURY OR DEATH

- Read the Owner's Manual.
- Go across slopes, not up and down.
- Do not mow when children or others are around.
- Look down and behind before and while mowing backwards.
- Remove objects that could be thrown by the blade.
- Keep safety devices in place and working.

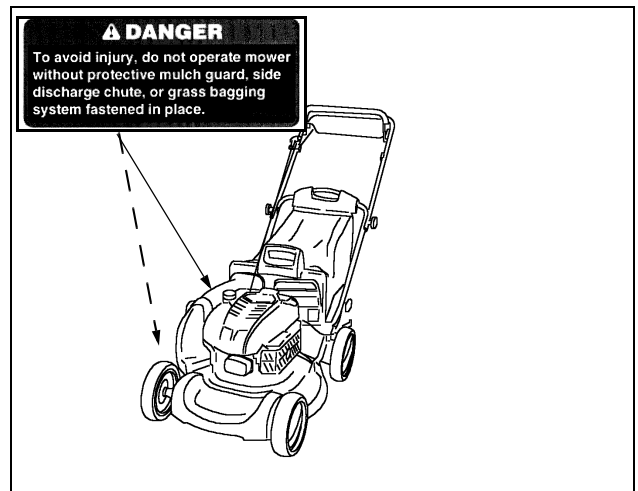

DANGER:

To avoid injury, do not operate mower without protective

SAFETY

mulch guard, side discharge chute or grass bagging system fastened in place.

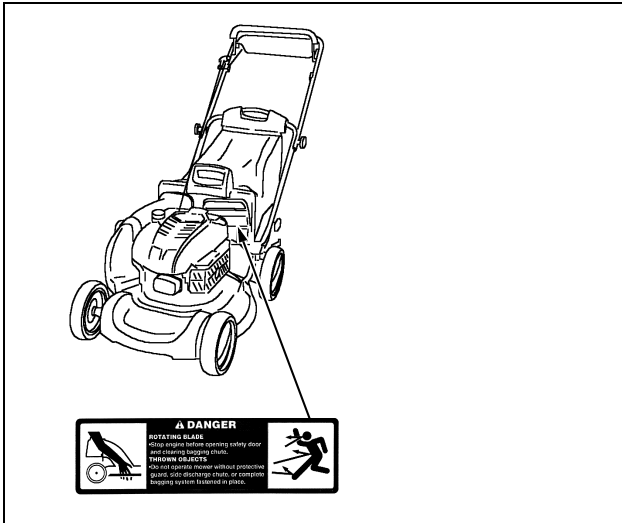

DANGER: ROTATING BLADE

- Stop engine before opening safety door and clearing bagging chute.

THROWN OBJECTS

- Do not operate mower without protective guard, side discharge chute, or complete bagging system fastened in place.

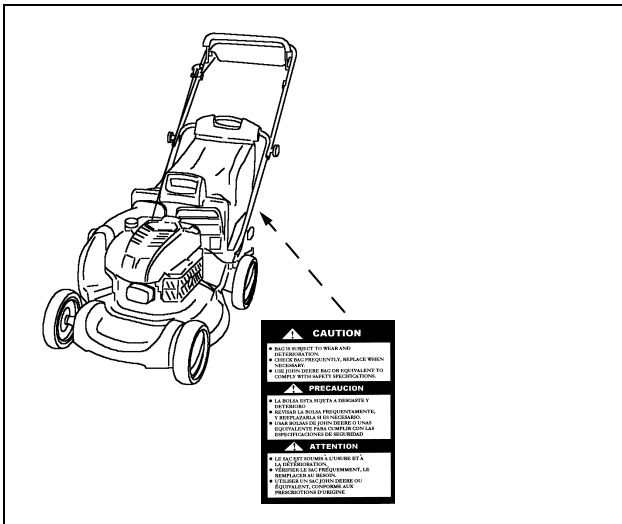

CAUTION

- Bag is subject to wear deterioration.
- Check bag frequently, replace when necessary.
- Use John Deere bag or equivalent to comply with safety specifications.

Certification Label

The OPEL label on your mower indicates that this model has been certified by an independent laboratory for compliance with American National Standard B-71.1, "Safety Specifications" for Power Lawn Mowers, Lawn and Garden Tractors, and Lawn Tractors.

SAFETY

Operate Safely

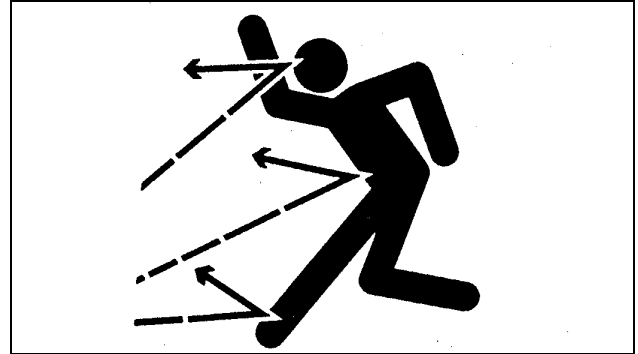

- Inspect machine before you operate. Be sure hardware is tight. Repair or replace damaged, badly worn, or missing parts. Be sure proper guards, plates, grass catcher, or other safety protective devices are in good condition and fastened in place. Make any necessary adjustments before you operate.
- Clear work area of objects that might be thrown. Keep people and pets out of the work area. Stop machine if anyone enters the area.
- If you hit an object, stop the machine and inspect it. Make repairs before you operate. Keep machine properly maintained and in good working order.
- DO NOT leave machine unattended when it is running.
- Only operate during daylight or with good artificial light.
- Be sure of footing. Be especially careful when you pull machine backwards with the engine running.
- Mow across a hill - not up and down. Be careful when you change direction on a slope. DO NOT mow excessively steep slopes.
- DO NOT mow wet grass. Reduced traction could cause you to slip.
- Keep a firm hold on the machine handle.
- DO NOT wear radio or music headphones while operating the machine. Safe operation requires your full attention.
- DO NOT operate mower if you are under the influence of drugs or alcohol.

SAFETY

Rotating Blades are Dangerous - Protect Children and Prevent Accidents

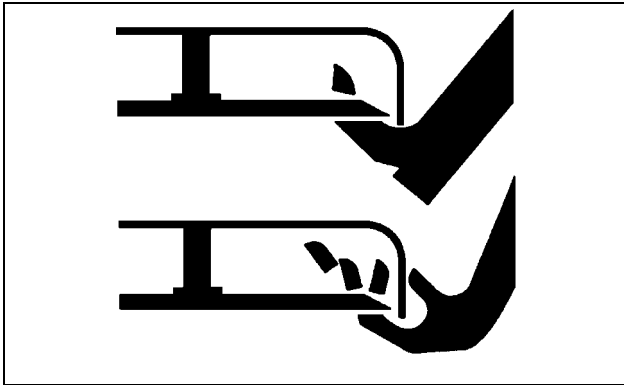
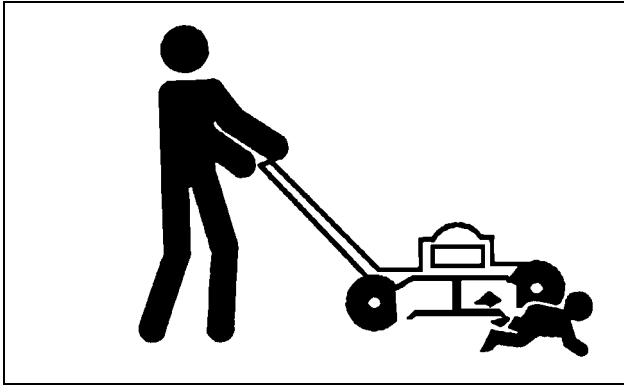

PROTECT CHILDREN:

- Never assume that children will remain where you last saw them. Children are attracted to mowing activity, stay alert to the presence of children.
- Keep children in the house when you are operating the machine.
- Turn machine off if a child enters the area.
- Use extra care when you come to blind corners, shrubs, trees, or other objects that may block your vision.
- DO NOT let children or an untrained person operate the machine.

HELP PREVENT SERIOUS OR FATAL ACCIDENTS:

- Be alert at all times, people especially children can move quickly into the area before you know it.
- Stop the blade when crossing gravel drives, walks, or roads.
- Shut off blades when you are not mowing.
- Keep hands, feet, and clothing away from rotating blades.

Wear Appropriate Clothing



- Wear close fitting clothing and safety equipment appropriate for the job.
- Do Not operate the equipment when barefoot or wearing open sandals. Always wear substantial footwear.
- Loud noise can cause impairment or loss of hearing, wear a suitable protective device such as earplugs.

Practice Safe Maintenance



- Understand service procedure before doing work. Keep area clean and dry.
- Never lubricate, service, or adjust machine while it is moving. Keep safety devices in place and in working condition. Keep hardware tight.
- To prevent them from getting caught, keep hands, feet, clothing, jewelry, and long hair away from any moving parts.
- Before servicing machine, disengage all power and stop the engine. Let engine cool.
- Securely support any machine elements that must be raised for service work.
- Keep all parts in good condition and properly installed. Fix damage immediately. Replace worn or broken parts. Remove any buildup of grease, oil, or debris.
- Unauthorized modifications to the machine may impair its function and safety.

SAFETY

Avoid Injury from Contacting Blade

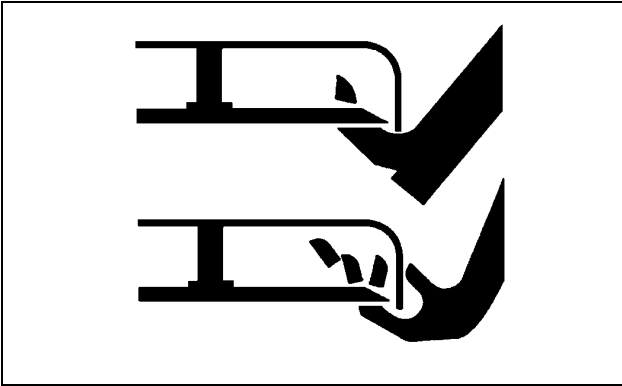

Before you unplug or adjust machine:

- STOP the engine.
- Wait for blade to STOP.
- Keep hands, feet and clothing away from blade when engine is running.

Handling Waste Products

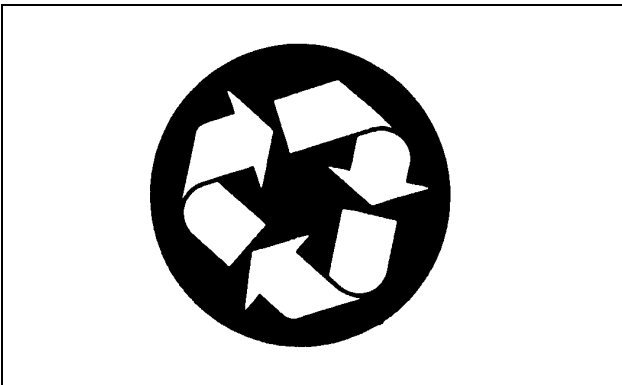

- Waste products, such as, used oil, fuel, and batteries, can harm the environment and people.
- DO NOT use beverage containers for waste fluids - someone may drink from them.
- See your local Recycling Center or authorized Scotts servicing dealer to learn how to recycle or get rid of waste products.
- A Material Safety Data Sheet (MSDS) provides specific details on chemical products: physical and health hazards, safety procedures, and emergency response techniques. The seller of the chemical products used with your machine is responsible for providing the MSDS for that product.

Handling Fuel Safely

Fuel and fuel vapors are highly flammable:

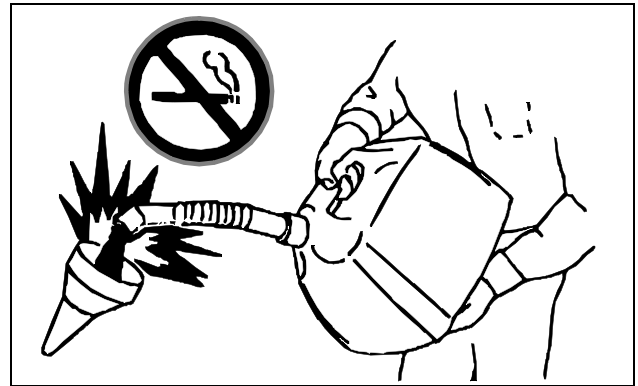

- DO NOT refuel machine while you smoke, when machine is near an open flame or sparks, or when engine is running. STOP engine.
- Fill fuel tank outdoors.
- Prevent fires: clean oil, grease and dirt from machine. Clean up spilled fuel immediately.
- Do not store machine with fuel in tank in a building where fumes may reach an open flame or spark.
- Prevent fire and explosion caused by static electric discharge. Use only non-metal, portable fuel containers approved by the Underwriter's Laboratory (U.L.) or the American Society for Testing & Materials (ASTM). If using a funnel, make sure it is plastic and has no screen or filter.
- Static electric discharge can ignite gasoline vapors in an ungrounded fuel container. Remove the fuel container from the bed of a vehicle or the trunk of a car and place on the ground away from the vehicle before filling. Keep nozzle in contact with container opening while filling.



- When practical, remove equipment from trailers or truck beds and refuel them on the ground. If this is not possible, use a portable, plastic fuel container to refuel equipment on a truck bed or trailer.
- DO NOT use METHANOL gasoline. METHANOL is harmful to the environment and to your health.

OPERATING

Engine Controls

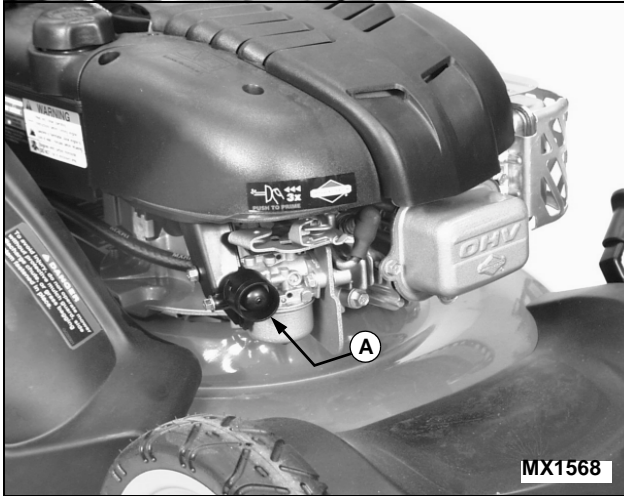

A - Primer Bulb

Handle Controls

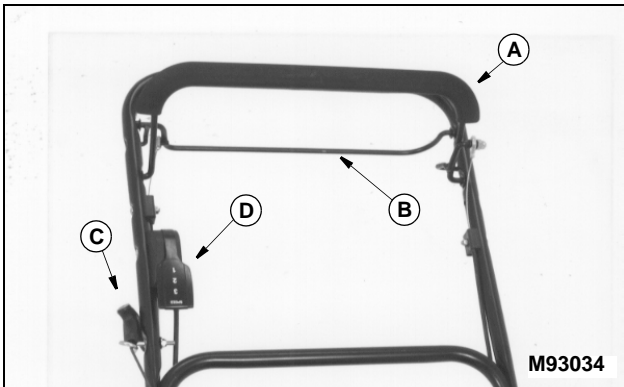

- A - Blade Control Lever
- B - Traction Clutch Lever
- C - Starter Handle
- D - Travel Speed Lever (SP6213)

Handle and Cutting Height Controls

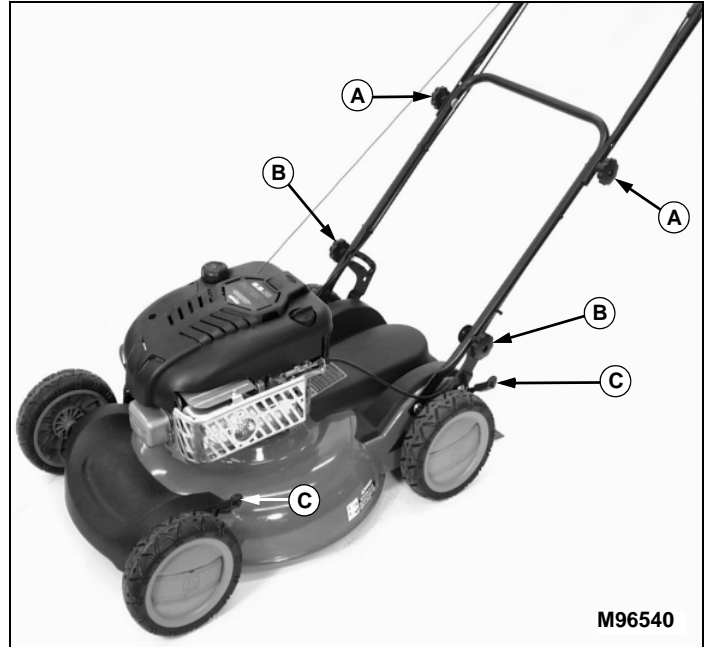

- A - Fold Handle Knobs
- B - Handle Height Knobs
- C - Cutting Height Levers

ADJUSTMENTS

Adjusting Cutting Height



CAUTION: Avoid injury! Before you adjust cutting height:
STOP ENGINE.

NOTE: Adjust both levers to same height except for **LOWEST** cutting height (A). This adjustment improves mulching performance at lowest cutting height:

- Put front wheel levers in 25 mm (1 in.) notch: First rear notch.
- Put rear wheel levers in 38 mm (1-1/2 in.) notch: Second rear notch.

To help move rear wheel lever:

1. Lift lower handlebar slightly with one hand to take some weight off wheel.
2. Move height adjustment lever to desired position with other hand.

OPERATING

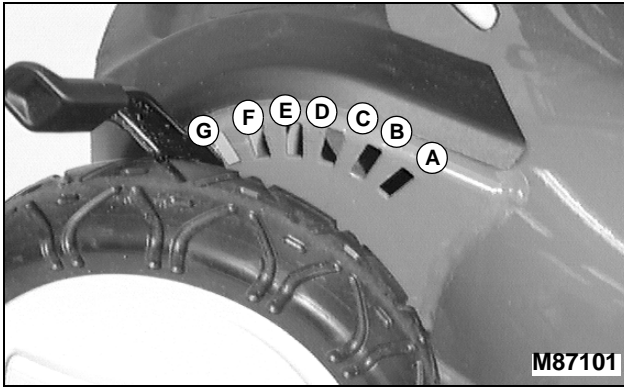

| Key | Cutting Height Adjustments In mm (Inches) |
|-----|---|
| (A) | 25 mm (1 in.) |
| (B) | 38 mm (1-1/2 in.) |
| (C) | 50 mm (2 in.) |
| (D) | 64 mm (2-1/2 in.) |
| (E) | 75 mm (3 in.) |
| (F) | 90 mm (3-1/2 in.) |
| (G) | 102 mm (4 in.) |



Adjusting Handle Height

Upper Handle:

NOTE: Upper handle height can be independently adjusted to two positions.

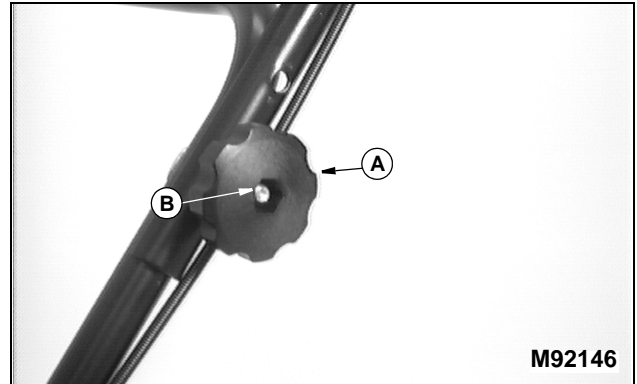

1. Remove knob (A) and bolt (B) from each side of upper handle.
2. Move handle to desired height.
3. Install bolt through matching holes in upper and lower handles on each side.
4. Install and tighten knob (A).

Lower Handle:

NOTE: Lower handle height can be independently adjusted to three positions.

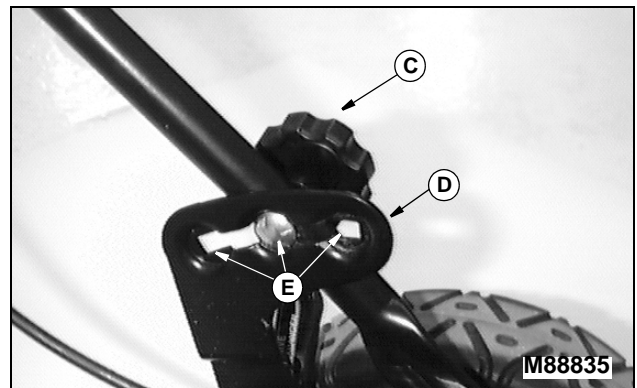

1. Loosen knob (C) approximately 25 mm (1 in.) on each side of handle.

NOTE: Carriage bolts must travel within slotted adjustment brackets and come to rest within one of the three height setting positions (E) before tightening.

2. Pivot handle to a desired height within slotted adjustment bracket (D).

OPERATING

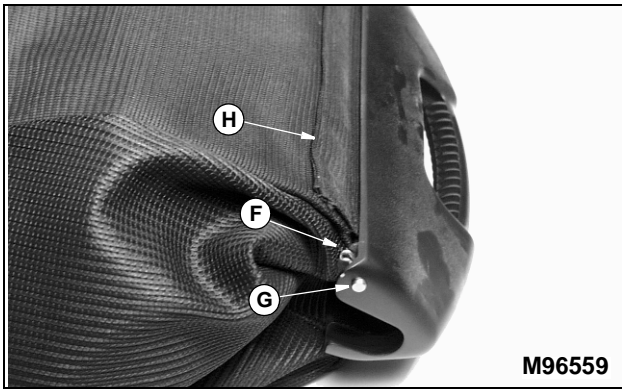

3. If bag prevents lowering of handle, remove clip (F) to remove rod (G). Remove rod from lower position (H) and insert in upper position as shown to lengthen bag.
4. Tighten knob (C) on each side of handle.

Starting Engine

CAUTION: Avoid injury! Engine exhaust fumes can cause sickness or death.
Run engine only in a ventilated area.
If engine is run in an enclosed area, open doors to bring in outside air.

IMPORTANT: Avoid damage! To help prevent damage to recoil starter and band brake, do not start engine:

- When blade is under load, such as, in heavy grass.
- When blade control lever is released.

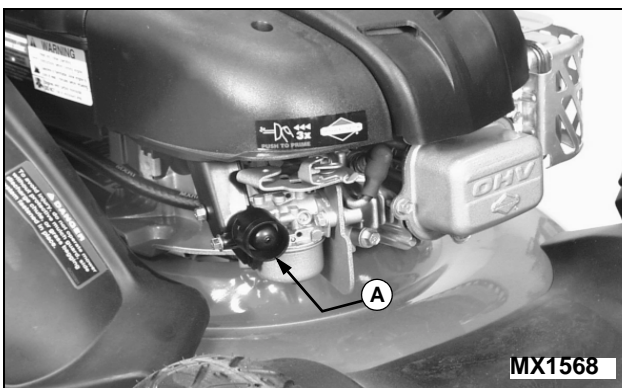

1. Prime engine by pressing primer bulb (A):
 - COLD Engine - 3 times
 - WARM Engine - 1 or 2 times

CAUTION: Avoid injury! WHEN ENGINE IS RUNNING, BLADE IS TURNING.
Keep hands, feet and clothing away from the blade.

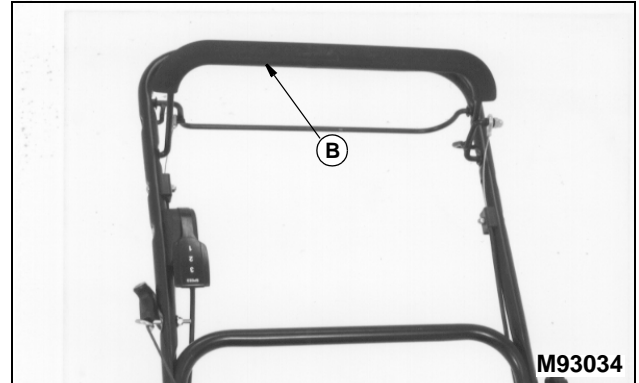

2. Hold blade control lever (B) against handle.

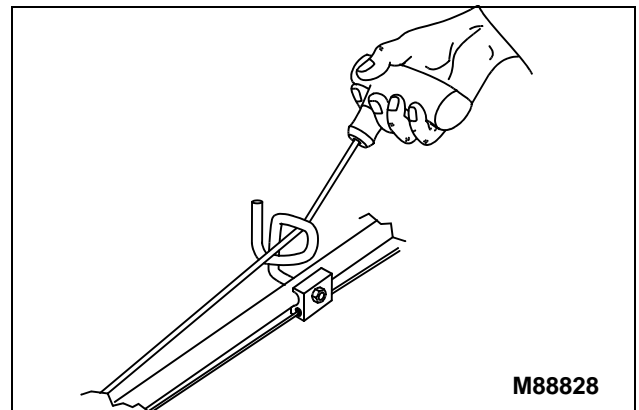

3. Pull starter handle until you feel resistance. Then pull fast and steady.
4. When engine starts, return rope slowly.

OPERATING

Forward Travel

To Travel Forward:

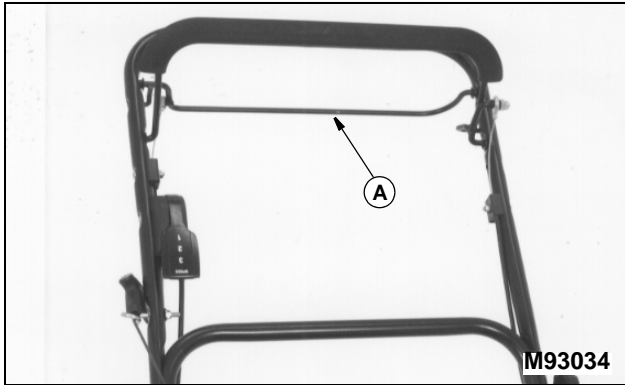

Pull and hold traction clutch lever (A) against upper handle.

To Stop Forward Travel:

NOTE: Rear wheels will make a clicking noise when mower is pushed forward. This indicates that the drive train is operating correctly.

Release lever (A). Release traction clutch lever before turning the mower.

Travel Speeds

Travel speed: (SP6211)

- 1st Gear: 3.9 km/h (2.4 mph)

Travel speeds: (SP6213)

- 1st Gear: 3.1 km/h (1.9 mph)
- 2nd Gear: 3.9 km/h (2.4 mph)
- 3rd Gear: 5.0 km/h (3.1 mph)

To change travel speeds: (SP6213)

NOTE: Mower travel speed can be changed when the traction clutch lever is engaged and the mower is moving forward.

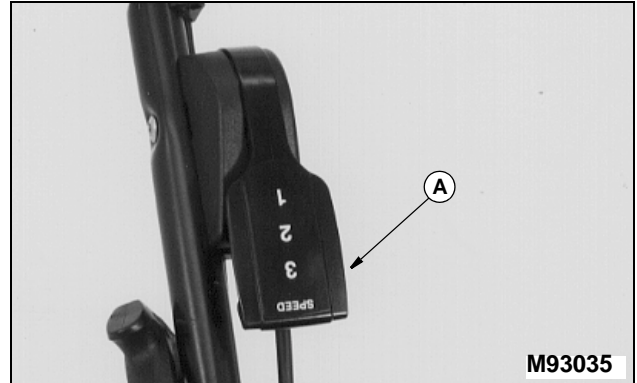

- Raise or lower speed control lever (A) to engage desired gear.

Stopping Engine

Release handle and levers:

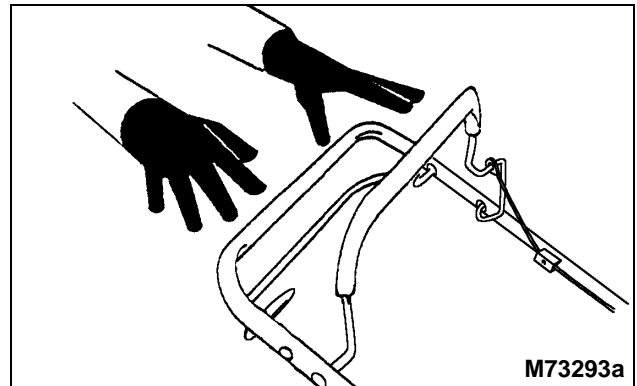

- Mower will stop.
- Blade will stop.
- Engine will stop.

IMPORTANT: Avoid damage! If blade does not stop within 3 seconds after you release blade stop lever, see your authorized Scotts servicing dealer.

OPERATING

Using Side Discharge Chute

CAUTION: Avoid injury! DO NOT operate mower unless grass bag assembly, side discharge chute or mulch guard is in place.

1. Release blade control lever to stop engine.

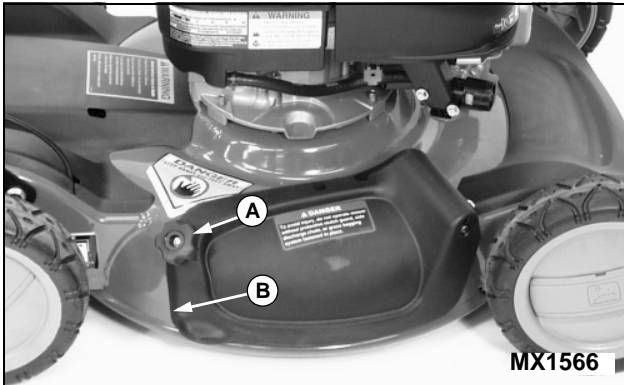

2. Remove mulch guard knob (A).

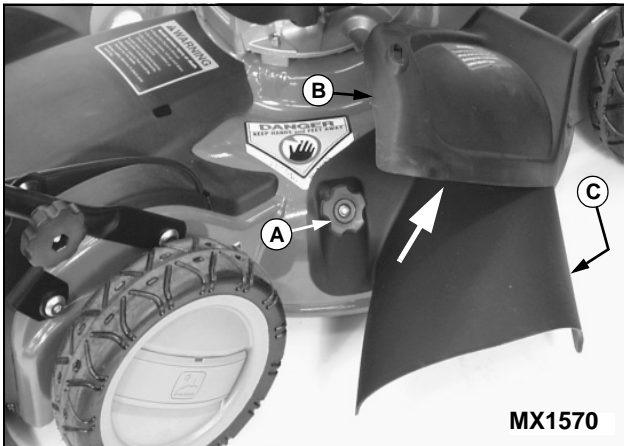

3. Lift and hold spring loaded mulch guard (B) up.
4. Install side discharge chute (C).
 - Slide side discharge chute under mulch guard mounting bracket.
 - Lower mulch guard.
 - Reinstall and tighten knob (A).

Using Grass Bag

CAUTION: Avoid injury! DO NOT operate mower unless mulch guard, side discharge chute or grass bag and bagging chute are in place.
Bagging chute MUST be removed and mulch guard secured in place when grass bag is not being used.

NOTE: Bag may wear and deteriorate. Check condition of bag often. Use a John Deere bag or equivalent to comply with safety specifications.

1. Release blade control lever to stop engine.
2. Grasp handle (A) and handle (B) from left side of mower. Lift bag off mower.

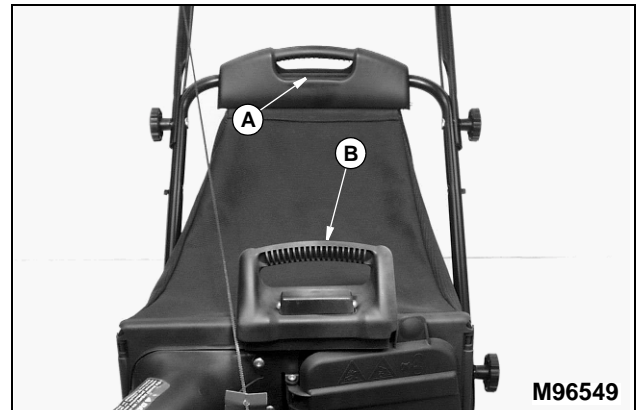

3. Lower front of bag. Raise rear of bag grasping handle (A) and handle (B).



4. Allow doors (C) to swing open. Shake contents of bag to empty out.

Mowing Tips

Before beginning to mow, be sure deck is level and proper cutting height is selected.

OPERATING

When you mow an area for the first time, travel SLOW and cut HIGH so you can:

- Learn the terrain.
- Learn the best mowing pattern.
- Help prevent hitting objects hidden in the grass.

Try to mow grass only when it is dry: Wet grass may plug mower and leave a trail of grass clumps.

Use a travel speed that fits the conditions:

- Travel SLOW when you mow thick, tall grass.
- FAST travel or sharp turns may produce stripes or uneven cut. Slow down. Short, fast turns may scuff ground and pull grass out by the roots.
- Travel at MODERATE speed when you mow a thin stand of grass.

Mow often enough so you cut only 1/3 of grass blade in one mowing. Cutting grass too short may kill grass and let weeds grow easily.

Aerate lawn to help stimulate soil organisms and root growth.

To Avoid Scalping

- Pay attention to the way you mow: scalping can be eliminated.
- If mower scalps easily, cutting height may be too low for ground conditions—especially on lawns with many small mounds and ridges.
- Mow over ridges and through shallow ditches straight-on, not at an angle.

Keep blade sharp: A dull blade will tear grass; tips of grass will then turn brown.

Check lawn regularly for uneven cut. If cut is uneven:

- Mower may not be level. Adjust cutting height levers.

Bagging Tips

For best performance, bagger needs good airflow. To help increase airflow:

- Keep underside of deck and chute clean.
- Cut grass high.

IMPORTANT: Avoid damage! DO NOT leave clippings in bag:

- **Moisture may damage bag.**
- **Damp clippings are a fire hazard.**

- Clean bag often with water from garden hose, from outside to inside of bag. Let bag dry before use.

When bag is full:

- Mower may leave a trail of clippings.
- Clippings may blow out from under deck.
- Top of bag will deflate.

Bagging and Composting

Many communities will no longer haul lawn clippings and leaves to landfills. Bagging and composting clippings and leaves is one way to solve this problem.

Clippings from grass bag may also be used as mulch, or sheet compost, between garden rows and around trees and shrubs. This mulch will:

- Keep weeds from growing.
- Help soil keep moisture.
- Add nutrients to soil as it decays.
- Help keep soil temperature down during hot weather.

You may compost clippings and leaves in various ways. See garden magazines or clubs for information, or go to your local library for help.

Finished compost is crumbly. It is rich in soil nutrients, and can be spread on your lawn. Compost may also be worked into soil. It adds humus to soil and improves soil texture, making soil looser and easier to work.

Mulching Tips

Advantages:

- You do not have to rake or bag grass or leaves.
- Lawn holds moisture better during dry weather.
- Soil temperatures stay down during hot weather.
- Mulch adds nutrients to soil, and reduces need for fertilizer.

Mulching does not make thatch. Frequent shallow watering and fertilizer application produce thatch from roots that grow close to surface.

Be careful when you mulch leaves in Fall. Grass needs

OPERATING

sunlight in Fall to help store food for Winter. A thick layer of mulched leaves can prevent sunlight from getting to grass and smother it. You may have to mow with grass bag to remove this layer.

Mulch leaves only when they are dry.

Mulching wet or damp grass or leaves may cause problems:

- Clippings and leaves may build up on the underside of the mower deck.
- Cut grass and leaves may form clumps.
- Leaves may not be cut into small bits.
- Engine will work harder and use more fuel.
- Clean underside of mower deck after mulching wet or damp grass.

If possible cut only top 1/3 of grass at a time.

Use a different mowing pattern each time you mow. Overlap mowing paths 50–100 mm (2–4 in.) instead of cutting a full swath with each pass.

Operate mower at a slower ground speed. Mulching takes more power.

Keep blade sharp. Check it often.

Keep underside of deck clean.

If clippings are not dispersed evenly or quality of cut is marginal, raise cutting height one or more positions.

After Mowing

- STOP engine. Let it cool. This will help prevent starting a fire when you store the mower.
- Remove and shake bag to remove all clippings. This will help to prevent deterioration of bag and starting a fire.
- Clean top of deck, engine, and chute with brush or compressed air, if possible. This will help to prevent buildup and starting a fire.
- Spray under deck with water under pressure to remove corrosive lawn chemicals and buildup.
- Put mower in safe storage.

REPLACEMENT PARTS

Service Literature

If you would like a copy of the Parts Catalog or Technical Manual for this machine call:

- **U.S. & Canada:** 1-800-522-7448.
- **All Other Regions:** Your John Deere dealer.

John Deere Quality

We recommend John Deere quality parts and lubricants, available at your authorized Scotts servicing dealer.

Part numbers may change, use part numbers listed below when you order. If a number changes, your dealer will have the latest number.

When you order parts, your authorized Scotts servicing dealer needs your machine product identification number and engine serial number. These are the numbers that you have recorded in the Product Identification section of this manual.

Touch-up paint is available in 340 grams (12 oz.) aerosol cans. Scotts Orange (part number: TY24745).

| ITEM | PART NUMBER |
|------------------------------|-----------------|
| Air Cleaner: | |
| • Foam Pre-cleaner | GC00440 |
| • Paper Element | GC00441 |
| Traction Drive Belt | |
| • SP6211 | GC00073 |
| • SP6213 | GC00081 |
| Standard Mulch Blade | GC00344 |
| Bagging Blade (Optional) | GC00175 |
| Spark Plug | Champion RC12YC |
| SAE 30, Engine Oil (1 quart) | TY22070 |

(Part numbers are subject to change without notice. Part Numbers may be different outside the U.S.A.)

SERVICE INTERVALS

Service Intervals

Please use the following timetables to perform routine maintenance on your machine. Service procedures included in this manual but not on this chart are to be performed on an as needed basis.

IMPORTANT: Avoid damage! If you operate mower in extreme heat, dust or other severe conditions, service more often than shown below.

Before Each Use

- Check oil level.

After Each Use

- Clean the mower.

First 5 Hour

- Change engine oil. (Break-in)
- Lubricate mower axles.
- Lubricate drive shaft hub bushings.

Every 25 Hours Or Once A Year

- Tighten blade bolt.
- Clean or replace air cleaner paper element.
- Clean and gap spark plug.
- Clean belt and transmission area.
- Change engine oil.
- Lubricate mower axles.
- Lubricate drive shaft hub bushings.

SERVICE

Engine Warranty Maintenance Statement

Maintenance, repair, or replacement of the emission control devices and systems on this engine, which are being done at the customer's expense, may be performed by any nonroad engine repair establishment or individual. Warranty repairs must be performed by an authorized Scotts servicing dealer.

Adjusting Carburetor

NOTE: Carburetor is calibrated by the engine manufacturer and should not require any adjustments.

NOTE: If engine is operated at altitudes above 1829 m (6,000 ft), some carburetors may require a special high altitude main jet. See your authorized Scotts servicing dealer.

If engine is hard to start or runs rough, check the TROUBLESHOOTING section of this manual.

After performing the checks in the troubleshooting section and your engine is still not performing correctly, contact your authorized Scotts servicing dealer.

Avoid Fumes



CAUTION: Avoid injury! Engine exhaust fumes can cause sickness or death:

- If it is necessary to run an engine in an enclosed area, use an exhaust pipe extension to remove the fumes.
- Always try to work in a well ventilated area.

Engine Oil

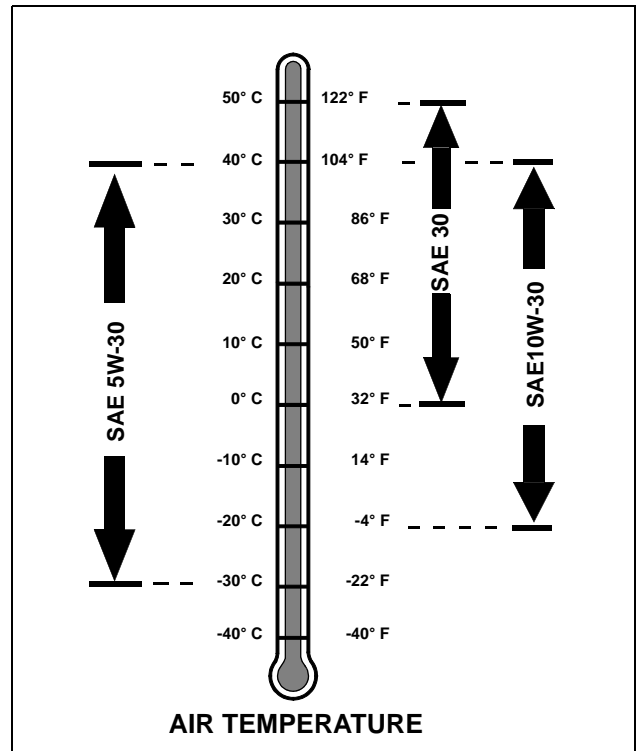

Use oil viscosity based on the expected air temperature range during the period between oil changes.

The following John Deere oils are preferred:

- TORQ-GARD SUPREME® (SAE 30)

The following John Deere oils are also recommended, based on their specified temperature range:

- TURF-GARD® (SAE 10W-30)
- PLUS-4® (SAE 10W-30)

Other oils may be used if above John Deere oil is not available, provided they meet one of the following specifications:

- SAE 10W-30—API Service Classification SG or higher
- SAE 30—API Service Classification SC or higher

Checking Engine Oil Level



CAUTION: Avoid injury! Before you check or add oil, STOP engine. Let it cool.

1. Stop engine. Put mower on a level surface.

SERVICE



2. Turn oil dipstick (A) 1/4 turn counterclockwise. Remove dipstick and wipe it with a clean cloth.

IMPORTANT: Avoid damage! If oil level is below the ADD mark, DO NOT run the engine.

3. Install dipstick. Turn dipstick 1/4 turn clockwise and tighten.

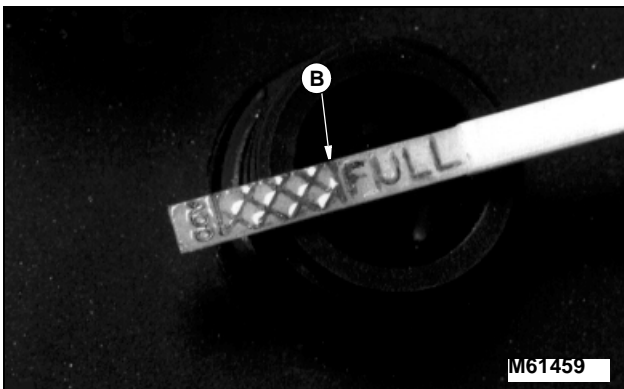

4. Remove dipstick. Check oil level. Oil level **MUST BE** between ADD and FULL marks. If not, pour oil into dipstick tube to bring level to FULL mark (B).
5. Install and tighten dipstick.

Changing Engine Oil



CAUTION: Avoid injury!

- Used oil may harm environment and people if it is dumped on the ground or into a drain or a body of water. Call your local Recycling Center or authorized Scotts servicing dealer to learn how to recycle used oil.
- Engine may be hot, use caution to avoid burns to the hands.

IMPORTANT: Avoid damage!

- Change oil after first 5 hours of operation.
- Change oil while engine is warm.
- If mower is not operated 25 hours during the mowing season, change oil before storing mower.
- Help prevent air cleaner damage and hard starting, turn mower onto the LEFT side when servicing.

NOTE: Two different methods can be used for changing the engine oil. Both options are acceptable service procedures based on customer preference.

TO CHANGE ENGINE OIL FROM THE TOP:

1. Park mower on a level surface.
2. Run engine until fuel tank is empty or near empty.
3. Stop engine and disconnect spark plug wire.



4. Turn oil dipstick (A) 1/4 turn left and remove from the filler tube.

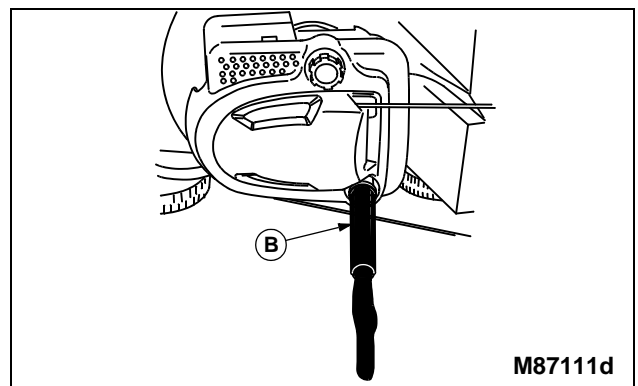

5. Insert plastic drain tube (B) firmly inside filler tube opening.
6. Place a drain pan on the left side of the mower.

SERVICE



CAUTION: Avoid injury! Fuel is highly flammable. Prevent fuel from contacting hot surfaces: DO NOT drain fuel tank. Run engine until fuel tank is very low or empty before turning mower on side to change oil.

7. Turn mower onto its LEFT SIDE.
8. Allow engine oil to drain from the dipstick filler tube location into the drain pan.
9. After oil has drained, return mower to an upright position.
10. Remove plastic drain tube. Clean area around filler tube.
11. Add 0.47 L (16 oz) oil through dipstick filler tube.
12. Install dipstick. Turn dipstick 1/4 turn right to tighten.
13. Remove dipstick. Check oil level. Add oil to FULL mark if necessary.
14. Install and tighten dipstick.
15. Connect spark plug wire.



CAUTION: Avoid injury! Be careful of sharp edges on mower blades. Wear gloves when working under deck.

TO CHANGE ENGINE OIL FROM THE BOTTOM:

1. Stop engine and disconnect spark plug wire.

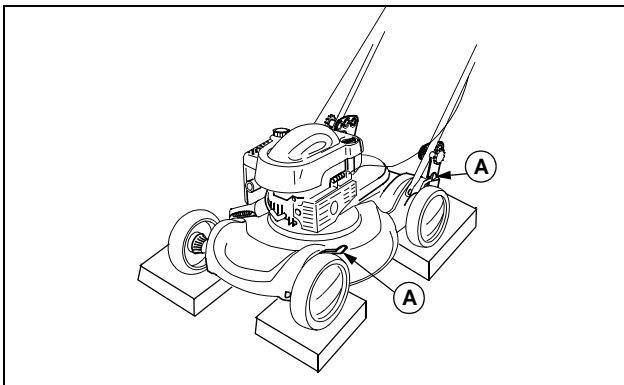

2. Raise cutting height adjustment levers (A) to the highest cutting position. (See Adjusting Cutting Height in the Operating section.) Elevate entire mower an additional 102 mm - 203mm (4-8 in.) using wooden blocks or bricks.
3. Place a drain pan under the mower.

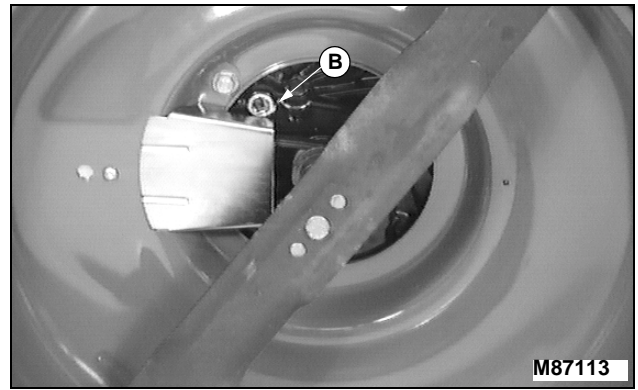

4. Remove drain plug (B) from underside of mower using a 3/8 in. square drive.
5. After oil has drained, clean and install drain plug.
6. Turn oil dipstick 1/4 turn to the left. Remove dipstick.
7. Add 0.47 L (16 oz) oil through dipstick filler tube.
8. Install dipstick. Turn dipstick 1/4 turn right to tighten.
9. Remove dipstick. Check oil level. Add oil to FULL mark if necessary.
10. Install and tighten dipstick.
11. Lower mower.
12. Return cutting height adjustment levers to a desirable cutting height.
13. Connect spark plug wire.

Cleaning and Replacing Air Cleaner Element



CAUTION: Avoid injury! Before you work on engine:

- STOP engine. Let it cool.

IMPORTANT: Avoid damage!

- If operation of the mower is done in very dusty conditions, clean element often.
- Replace paper element when engine starts hard, begins to lose power, or runs rough.
- DO NOT use a damaged element. Replace when necessary.
- DO NOT run engine without element.

1. Stop engine and disconnect spark plug wire.

SERVICE

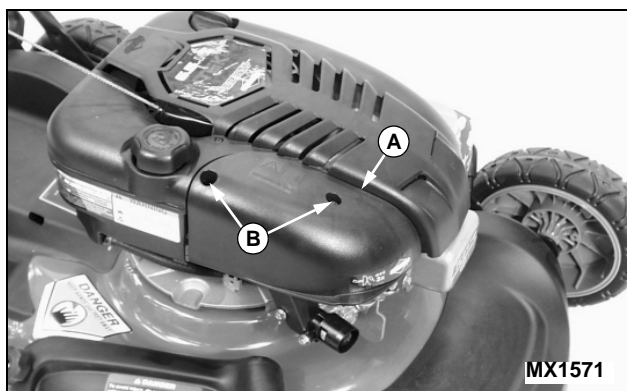

2. Clean area around cover (A).
3. Loosen screws (B) and remove cover.

NOTE: If precleaner or paper element has a break or is damaged, replace it.



4. If precleaner (C) is dirty, carefully remove paper element and precleaner. Remove precleaner from element (D).
5. If paper element is excessively dirty, replace it with a new element.
6. If precleaner is dirty, clean it as follows:
 - Wash it in a solution of warm water and liquid detergent. DO NOT wash paper element.
 - Rinse precleaner.
 - Allow precleaner to air dry.
7. Install precleaner on paper element and install air cleaner.
8. Install air cleaner cover and tighten screws.

Cleaning and Gapping Spark Plug



CAUTION: Avoid injury! Before you remove plug:

- STOP engine. Let it cool.

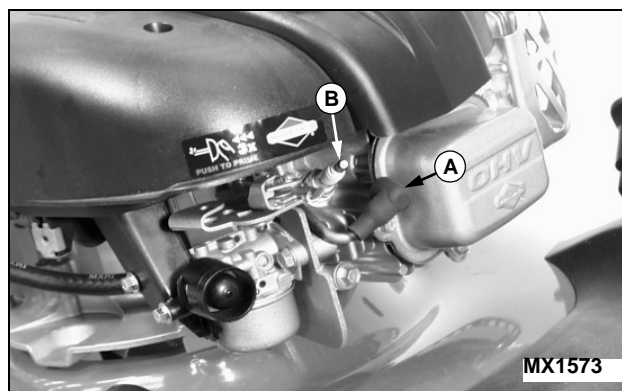

1. Disconnect spark plug wire (A). Remove plug (B).
2. Carefully wire brush carbon from plug. Do not clean it with abrasives in a machine.
3. Inspect plug for damage. Replace damaged plug.
4. Adjust gap to 0.51 mm (0.020 in.).
5. Install and tighten plug to 20 N•m (15 lb-ft).
6. Connect spark plug wire.

Cleaning Engine Cooling Fins



CAUTION: Avoid injury! Wear eye protection to guard against flying debris.

IMPORTANT: Avoid damage! Keep fins clean or engine may overheat.

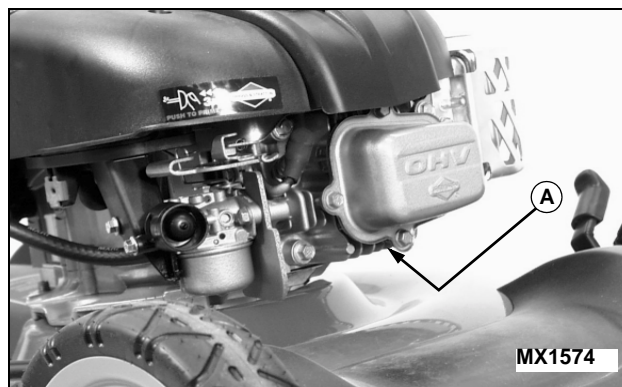

Clean fins (A) with a brush, rag, or compressed air. Also, blow compressed air under the shroud.

SERVICE

Cleaning Drive Belt and Transmission Area

CAUTION: Avoid injury! Before you remove shield:

- STOP engine. Let it cool.
- DO NOT operate mower without belt shield in place.

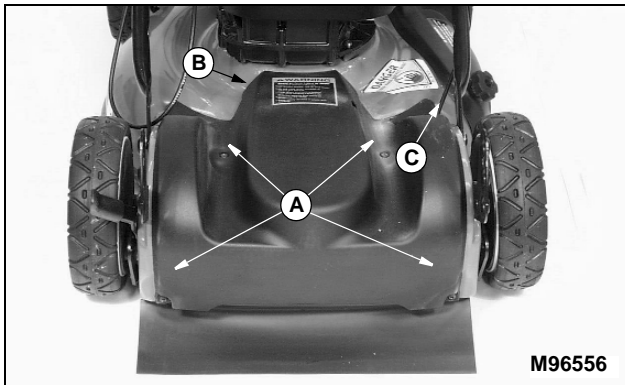

1. Remove hardware (A) and belt shield (B).

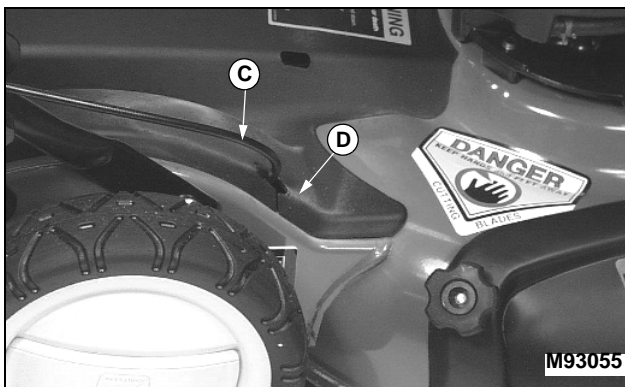

2. Remove control cables (C) from belt shield notch (D).

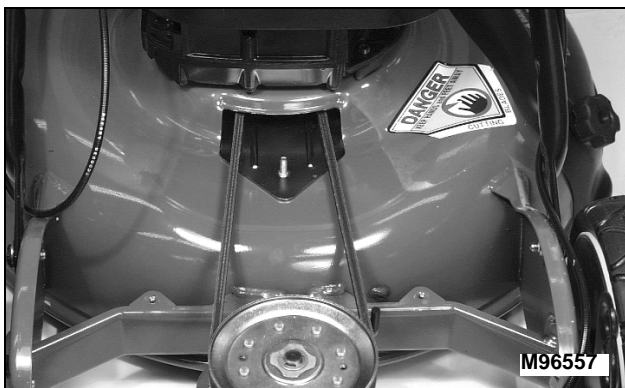

3. Remove clippings from belt area and top of the transmission.
4. Slide control cable into belt shield notch.

5. Install belt shield.

Checking and Replacing Drive Belt

CAUTION: Avoid injury! Before removing belt shield:

- Stop engine and wait for all moving parts to stop.
- Prevent burns by allowing engine to cool.
- Disconnect spark plug wire.
- Wear protective gloves when service is performed within the mower blade area.
- DO NOT operate mower without belt shield.

1. Stop engine and disconnect spark plug wire.

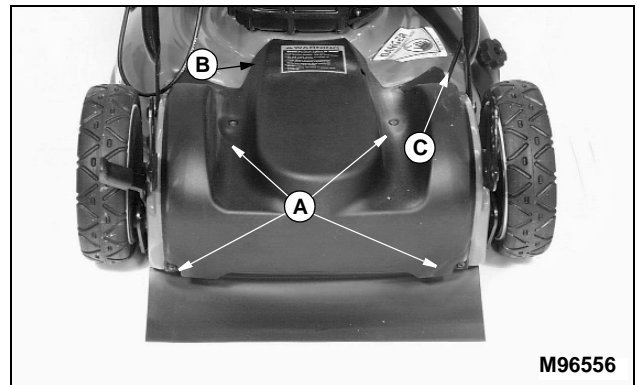

2. Remove hardware (A) and belt shield (B).

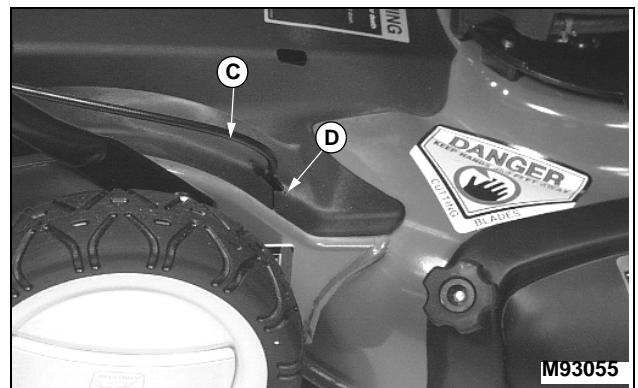

3. Remove control cables (C) from belt shield notch (D).

SERVICE

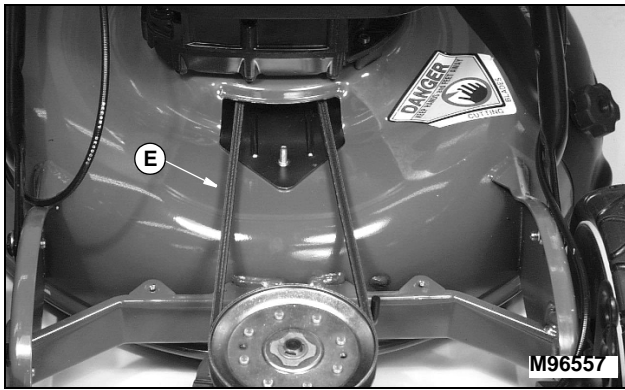

4. Inspect belt (E) for excessive wear or damage.

TO REPLACE DRIVE BELT:

NOTE: On model SP6211 only, the anti-rotation bracket must be removed prior to pushing the drive sheave forward to remove the drive belt.

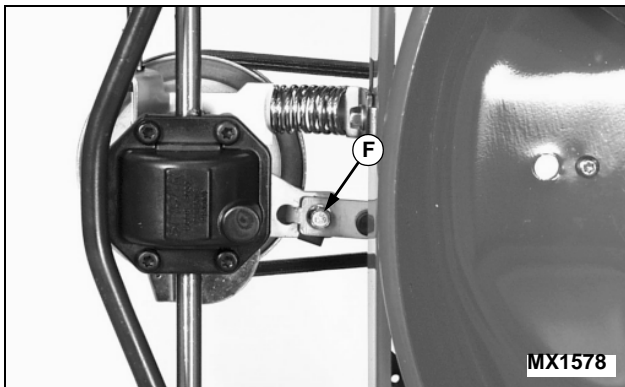

Picture Note: View is from underside of differential.

1. Remove cap screw (F) and anti-rotation bracket.



CAUTION: Avoid injury! Wear protective eyewear when removing belt from drive sheave. Tension spring may come loose.

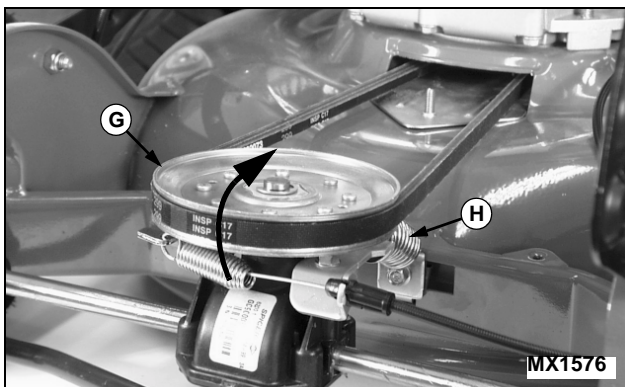

2. Push drive sheave (G) forward to relieve spring tension

on belt.

NOTE: Tension spring (H) may come loose when belt is removed.

3. Remove belt from drive sheave.
4. Move belt into underside of mower deck.
5. Turn mower onto its LEFT SIDE.
6. Remove mower blade. (See Check Blade in this section.)
7. Remove drive belt from blade sheave.
8. Install new drive belt to blade sheave.

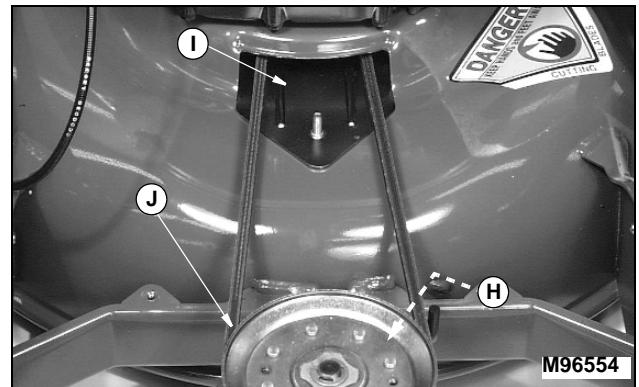

9. Insert belt through deck opening (I).
10. Install tension spring (H) if removed.
11. Check that drive belt is installed on engine sheave.
12. Push drive sheave (J) forward and install belt to sheave.
13. Install anti-rotation bracket and secure with cap screw.
14. Install mower blade.
 - Tighten mower blade bolt to 75 N•m (55 lb-ft).
15. Lower mower.
16. Slide control cables into belt shield notch.
17. Install belt shield and connect spark plug wire.

SERVICE

Transmission Cable Adjustment—SP6213



CAUTION: Avoid injury! Before removing belt shield:

- Stop engine and wait for all moving parts to stop.
- Prevent burns by allowing engine to cool.
- Disconnect spark plug wire.
- Wear protective gloves when service is performed within the mower blade area.
- **DO NOT** operate mower without belt shield.

1. Stop engine and disconnect spark plug wire.

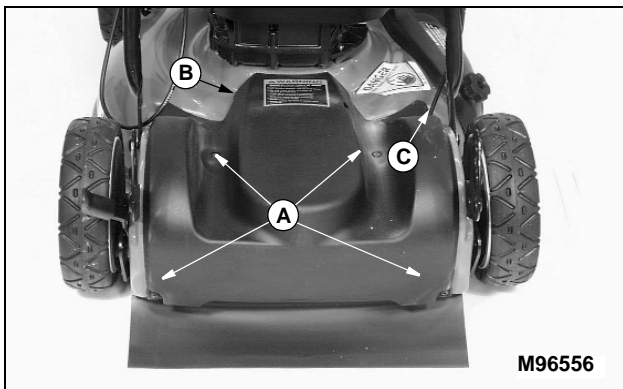

2. Remove hardware (A) and belt shield (B).



CAUTION: Avoid injury! Wear protective eye wear when removing belt from drive sheave. Tension spring may come loose.

NOTE: Transmission cable adjustment can be performed without removing belt and pulley. The belt and pulley have been removed for clarity of pictures.

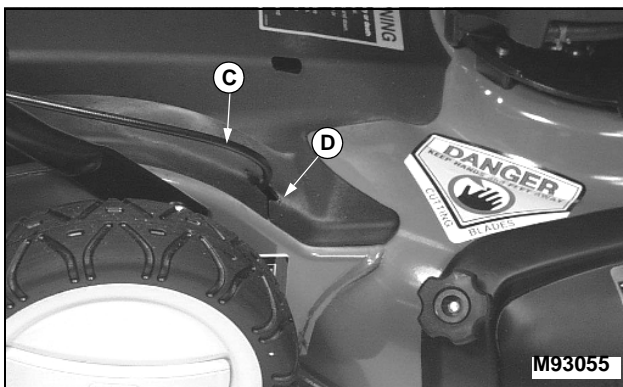

3. Remove control cables (C) from belt shield notch (D).

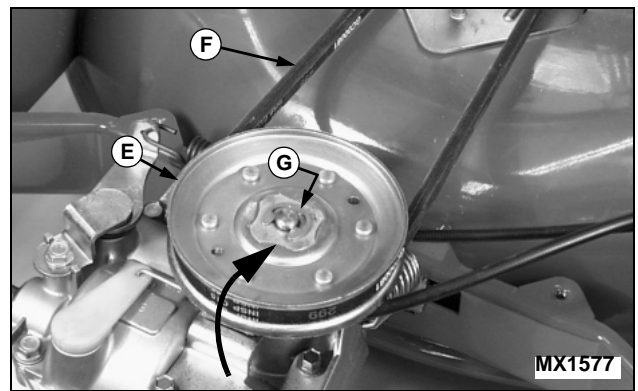

4. Push drive sheave (E) forward to relieve spring tension on belt and remove drive belt (F).

5. Remove E-clip (G) and drive sheave.

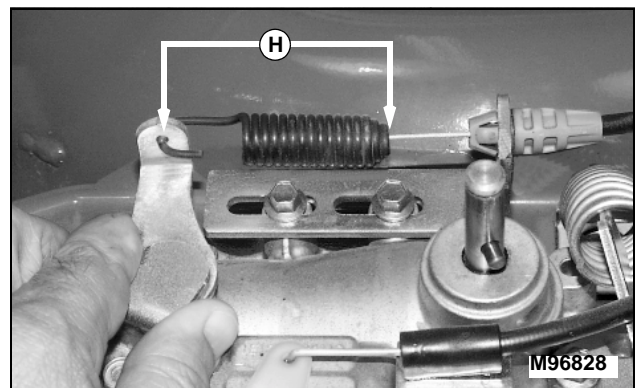

6. Measure the clutch spring length (H) in the relaxed position. Record this value.

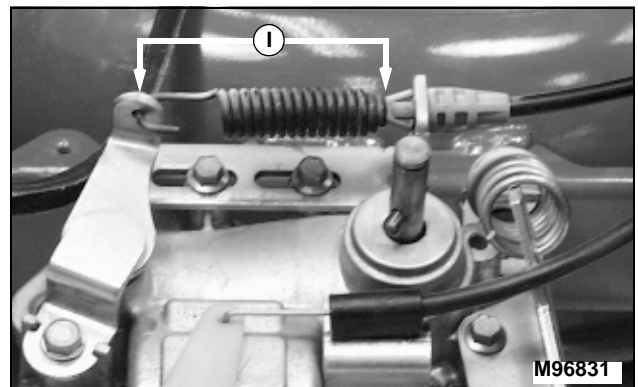

7. Engage the transmission bail (at handle bar) and measure the spring length in the extended position (I).

The spring extension length (the difference between A and B measurements) must be 10 mm (0.390 in.).

SERVICE

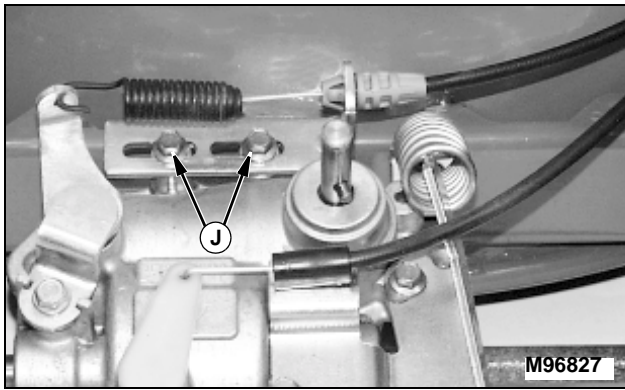

8. To adjust spring extension, use an 8 mm wrench, loosen (do not remove) the cable mount bracket cap screws (J).

NOTE: For transmission clutch to operate properly, there must be a certain amount of spring pressure engaging the cones or the transmission will slip and NOT drive the wheels.

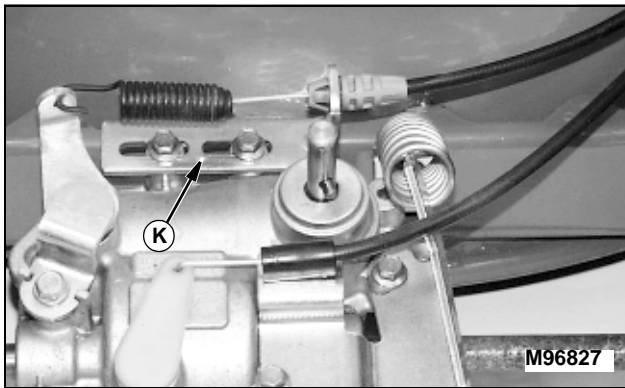

9. Slide bracket (K) the required distance to obtain the 10 mm (0.390 in.) spring extension length (difference between the length of the relaxed spring and the length of the extended spring). Tighten cap screws.

10. Repeat steps 6 and 7 to verify the 10 mm (0.390 in.) spring extension length.

11. Install drive sheave and E-clip.

12. Check that drive belt is installed on engine sheave.

13. Install transmission drive belt.

14. Install cables through notch in cover.

15. Install cover and secure with two bolts and two nuts. Make sure shield is installed with cover.

16. Start engine and verify the transmission is operating properly.

NOTE: Make sure the transmission immediately disengages when the bail is released.

17. If transmission does not disengage when bail is released, reduce spring extension length, and verify transmission is operating properly.

Lubricate Drive Shaft Hub Bushings

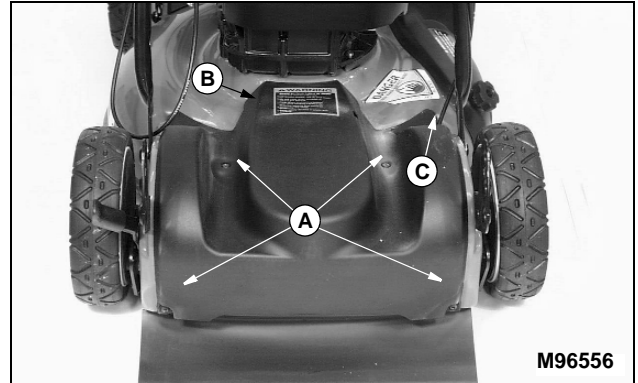

1. Remove hardware (A) and belt shield (B).

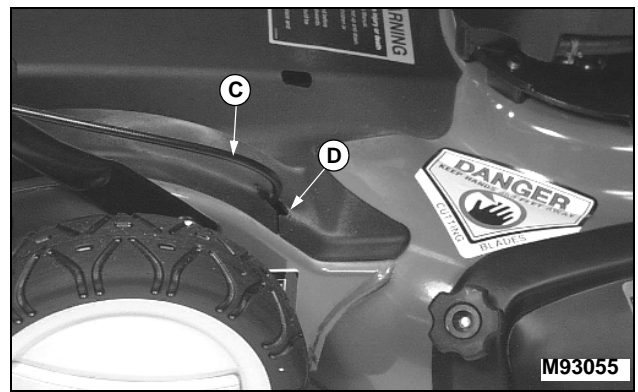

2. Remove control cable (C) from belt shield notch (D).

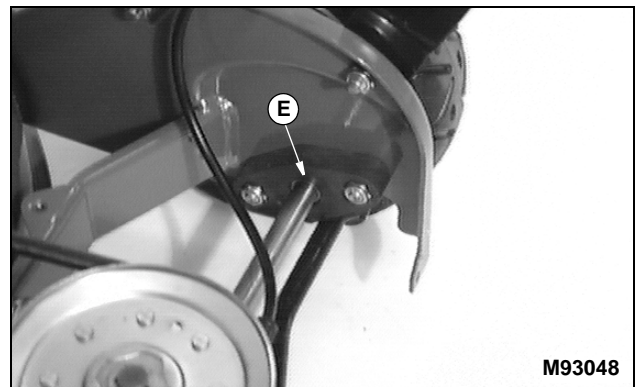

3. Tilt mower slightly to one side. Lubricate driveshaft hub bushing (E) with a few drops of light weight motor oil. Repeat procedure for other side.

4. Slide control cables (C) into belt shield notch (D).

5. Install belt shield.

Lubricate Mower Axles

1. Tip mower to one side to elevate mower wheels slightly off the ground. Use a wood block to keep side of mower in a

SERVICE

raised position.

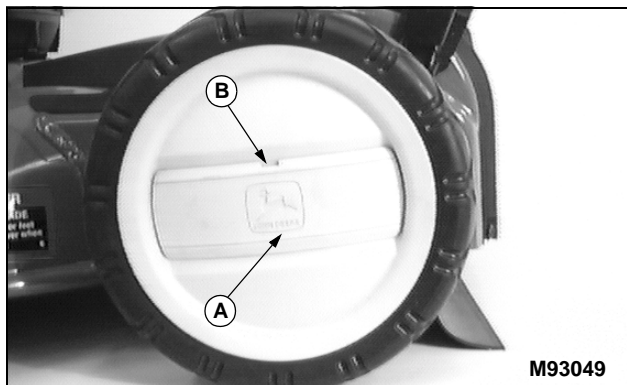

2. Remove plastic hubcaps (A).
 - Use a screwdriver in slot (B) to pry the hubcap from each wheel.

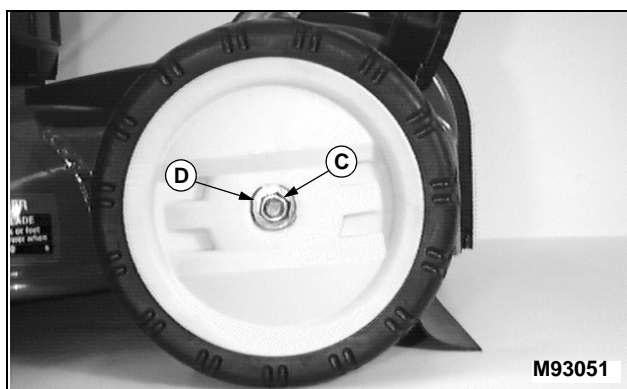

3. Remove locknut (C) and washer (D).
4. Remove wheel from each axle.

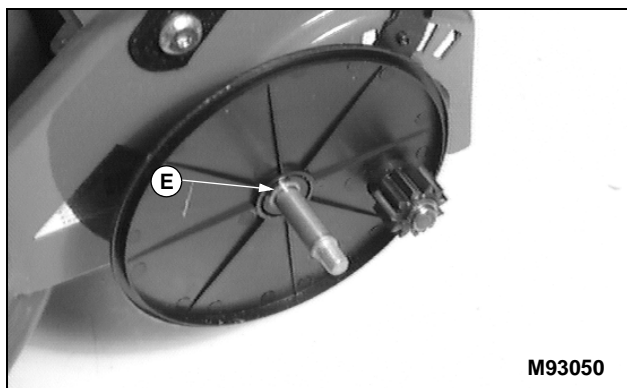

5. Apply a light coating of grease to each axle (E).
6. Install wheels, hardware and hubcaps.
7. Lower mower.
8. Repeat procedure on other side of mower.

Check Blade

CAUTION: Avoid injury! Service blade safely:

- STOP engine. Let it cool.
- Disconnect spark plug wire.
- Wear gloves or wrap blade with a rag.

IMPORTANT: Avoid damage!

Turn mower on its **LEFT SIDE** to help prevent air cleaner damage and hard starting.

NOTE: Sharpened edges on blade tips must face upward when installing blade.

CHECK BLADE:

- Replace damaged blade.

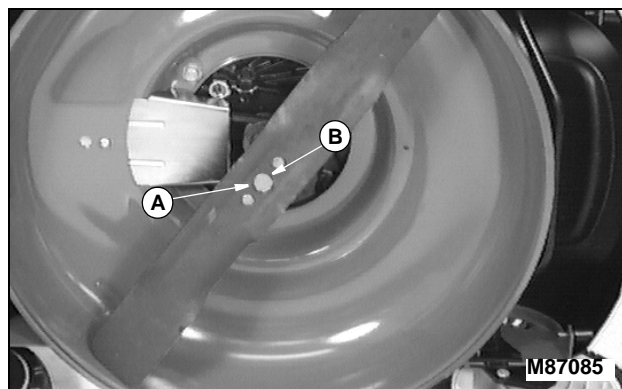

- Tighten Bolt (A) to 75 N•m (55 lb-ft).
- Sharpen dull blade. (See Sharpening Blade in this section.)

TO REMOVE BLADE:

- Remove bolt (A), washer (B), and blade.

Sharpening Blade

CAUTION: Avoid injury! Wear gloves and goggles when sharpening, balancing or installing blade.

IMPORTANT: Avoid damage! Balance blade after you sharpen it. An unbalanced blade may cause excessive vibration.

Sharpen blade with grinder, hand file or electric blade

SERVICE

sharpener.

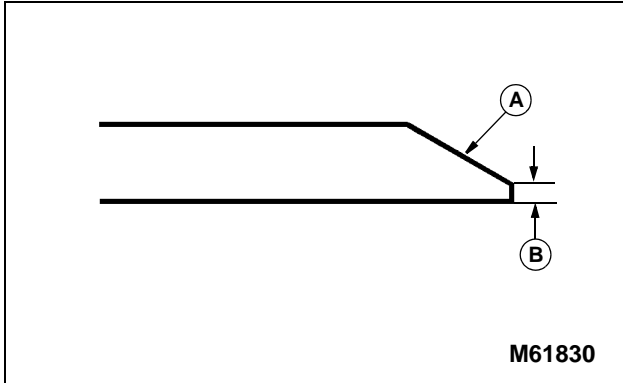

Keep original bevel (A) when you grind. Blade should have 0.40 mm (1/64 in.) cutting edge (B).

Balance and Install Blade

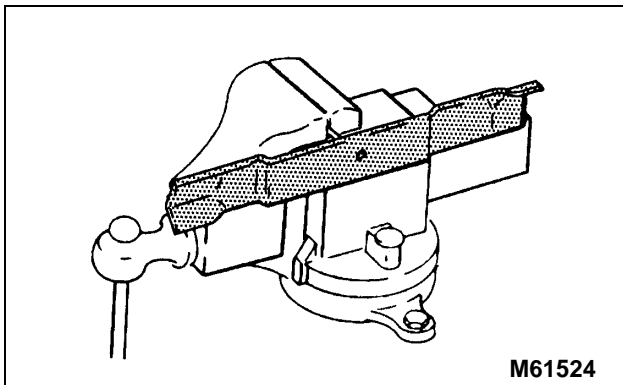

1. Clean blade. Put it on a nail in vise or on a wall. Heavy end of blade will drop. Grind bevel of heavy end. Do not change bevel.
2. Install blade, washer, and bolt.
3. Tighten bolt to 75 N•m (55 lb-ft).

Filling Fuel Tank

Use regular grade 87 octane unleaded fuel.

Add John Deere fuel stabilizer to fuel before using it in your machine to prevent engine damage due to stale fuel. Follow directions on stabilizer container.

IMPORTANT: Avoid damage! Dirt and water in fuel are major causes of engine performance problems. Prevent dirt and debris from entering the fuel tank when filling.

- Use a non-metallic funnel with a non-metallic mesh strainer when filling fuel containers.
- Use a non-metallic funnel with a non-metallic mesh strainer when filling the fuel tank.
- Fill the fuel tank at the end of each day's operation to keep condensation out of the fuel tank.
- Use clean, fresh, stabilized fuel.

Fuel tank capacity is 1.5 L (1.6 qt).

1. STOP engine. If engine is hot let it cool several minutes before you add fuel.
2. Remove grass clippings and other trash from tank area.



3. Remove fuel tank cap (A).
4. Fill tank with fuel only to bottom of filler neck.
5. Install fuel tank cap.

SERVICE

Cleaning Fuel Cap Vent

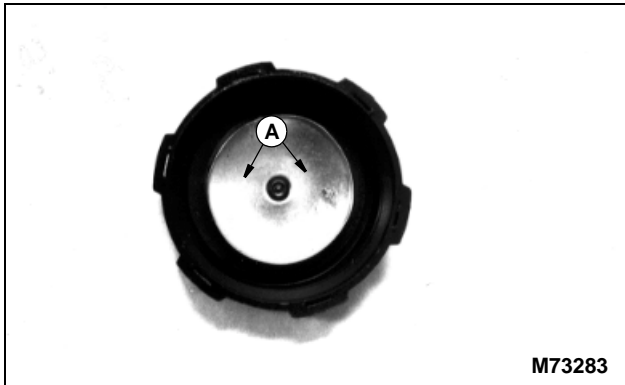

1. Check two vents (A) under metal ring of fuel cap and vent in top, center of cap.
2. Clean cap and vents in nonflammable solvent. Allow cap to dry.
3. Install the cap.

TROUBLESHOOTING

Using Troubleshooting Chart

If you are experiencing a problem that is not listed in this chart, see your authorized Scotts servicing dealer.

When you have checked all the possible causes listed and you are still experiencing the problem, see your authorized Scotts servicing dealer.

| IF | CHECK |
|-----------------------------------|--|
| Engine Will Not Start | <ul style="list-style-type: none">• Prime engine, (Cold - three times, Warm - 1 or 2 times)• Fuel tank is empty.• Stale or dirty fuel.• Disconnected or dirty spark plug. |
| Engine Starts Hard Or Loses Power | <ul style="list-style-type: none">• Dirty fuel tank cap vents.• Stale or dirty fuel.• Dirty air cleaner element.• Disconnected or dirty spark plug. |
| Engine Runs Rough | <ul style="list-style-type: none">• Carburetor needs to be cleaned.• Disconnected or dirty spark plug.• Dirty air cleaner element.• Dirty cooling fins. |
| Engine Overheats | <ul style="list-style-type: none">• Dirty blower housing and cooling fins.• Improper oil level. |
| Engine Vibrates Too Much | <ul style="list-style-type: none">• Loose blade bolt.• Blade dull.• Blade improperly balanced.• Bent blade or crankshaft. |
| Mower Mows Unevenly | <ul style="list-style-type: none">• Pushing mower too fast.• Mowing too fast around corners and mowing pattern not changed.• Insufficient overlapping of cuts when mowing.• Blade dull or not balanced. |
| Bagging Chute Plugs | <ul style="list-style-type: none">• Grass not dry.• Cutting height not raised high enough.• Dirty or full grass bag.• Mowing too fast. |
| Mower Will Not Self-propel | <ul style="list-style-type: none">• Traction belt broken.• Traction belt jumped off pulley.• SP6213 Only, Adjust Transmission Cable• Traction cable stretched or broken. |

TROUBLESHOOTING

| IF | CHECK |
|--|---|
| Mulched Grass Appearance Is Poor: Clumps, Excessive Clippings, Rough Cut, Etc. | <ul style="list-style-type: none">• Grass buildup under deck.• Travel speed too fast.• Blade dull or not balanced.• Cutting height set too low.• Tall grass conditions may dictate that more overlapping of cuts is required. |

STORING MACHINE

Storing Safety



CAUTION: Avoid injury! Engine exhaust fumes can cause sickness or death.

- If it is necessary to run an engine in an enclosed area, use an exhaust pipe extension to remove the fumes. Always try to work in a well ventilated area.
- **DO NOT** store mower with fuel in the tank inside a building where fumes may reach an open flame or spark.
- Allow engine to cool before storing in any enclosure.

Preparing Machine for Storage

1. Repair any worn or damaged parts. Replace parts if necessary. Tighten loose hardware.
2. Clean under the deck.
3. Sharpen mower blades.
4. Paint scratched or chipped metal surfaces to prevent rust.
5. Apply light coat of engine oil to pivot and wear points to prevent rust.
6. Lubricate grease points.

Preparing Fuel and Engine For Storage

Fuel:

If you have been using "Stabilized Fuel", add stabilized fuel to tank until the tank is full.

NOTE: Filling the fuel tank reduces the amount of air in the fuel tank and helps reduce deterioration of fuel.

If you are not using "Stabilized Fuel":

1. Stop mower in a well-ventilated area.

NOTE: Try to anticipate the last time the mower will be used for the season so very little fuel is left in the fuel tank.

2. Allow engine to run until it runs out of fuel.
3. Change engine oil and filter while engine is warm.

IMPORTANT: Avoid damage! Fuel without stabilizer can varnish and partially plug carburetor jets and passageways in a stored machine.

- Use fresh fuel when adding fuel stabilizer. Fuel stabilizers are ineffective when added to fuels that are more than 30 days old.

4. Mix fresh fuel and fuel stabilizer in separate container. Follow stabilizer instructions for mixing.
5. Fill fuel tank with stabilized fuel.
6. Run engine for a few minutes to allow fuel mixture to circulate through carburetor.

Engine:

Engine storage procedure should be used when mower is not to be used for longer than 60 days.

1. Service air filter if necessary.
2. Clean debris from engine air intake screen.
3. Remove spark plug. Put 30 mL (1 oz.) of clean engine oil in cylinder.
4. Install spark plug, but do not connect spark plug wire.
5. Slowly pull starter handle several times to allow oil to be distributed.
6. Store the mower in a dry, protected place. If mower is stored outside, put a waterproof cover over it.

Fold Handles

IMPORTANT: Avoid damage! **DO NOT CRIMP CABLES** when folding handle bars.

1. Remove grass bag and bagging chute if installed.

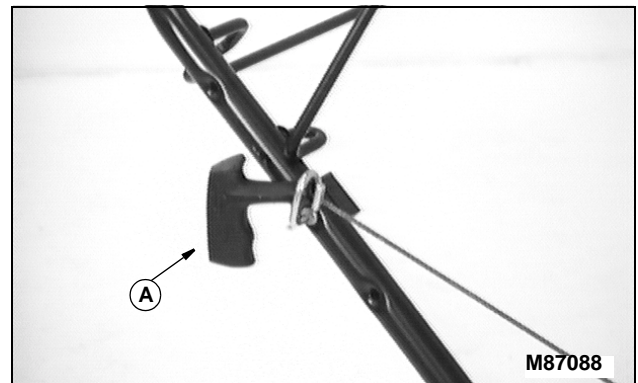

2. Remove starter handle (A) from rope guide.

STORING MACHINE

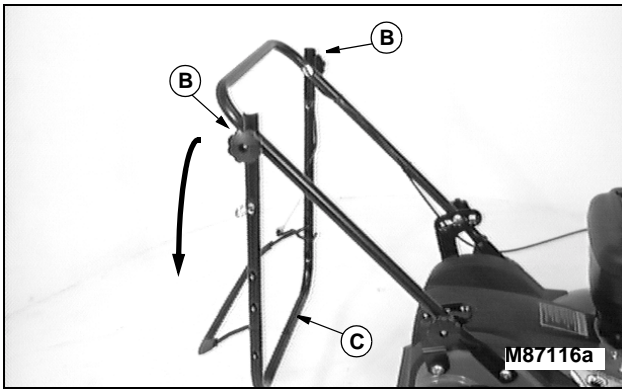

3. Loosen knob (B) 25 mm (1 in.) on each side. Allow upper handle (C) to pivot down.

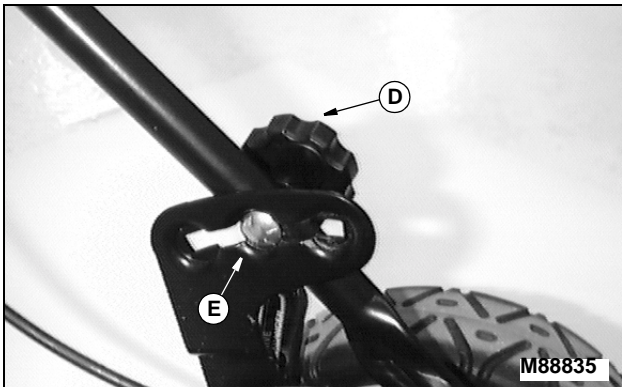

4. Remove knob (D) and carriage bolt (E) from each side.



5. CAREFULLY fold lower handle (F) forward. Guide cables inside lower handle. DO NOT CRIMP CABLES.
6. Install bolts and knobs in lower handle.

Remove Mower from Storage

1. Unfold handles. Tighten knobs. Do not crimp cables.
2. Check engine oil level.
3. Connect wire to spark plug.
4. Inspect shields, safety devices and hardware.

ASSEMBLY

Identify Parts (SP6211 and SP6213)

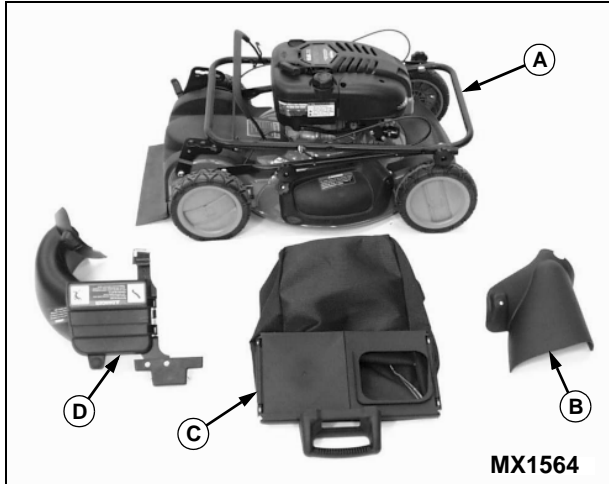

- A - Lawnmower Assembly
- B - Side Discharge Chute
- C - Bagger
- D - Bagger Chute

Unfold Handles

IMPORTANT: Avoid damage! Prevent damage to mower control cables when installing handle assembly. DO NOT pinch or crimp the control cables. Control cables must be inside of handle and unrestricted before tightening hardware.

1. Carefully remove mower from shipping carton.

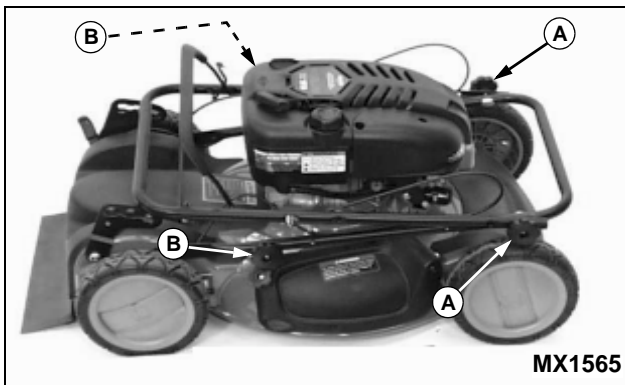

2. Loosen knob (A) approximately 25 mm (1 in.) on each side of upper handle.
3. Remove knob (B) and carriage bolt from each side.
4. Carefully pull folded handle assembly rearward.

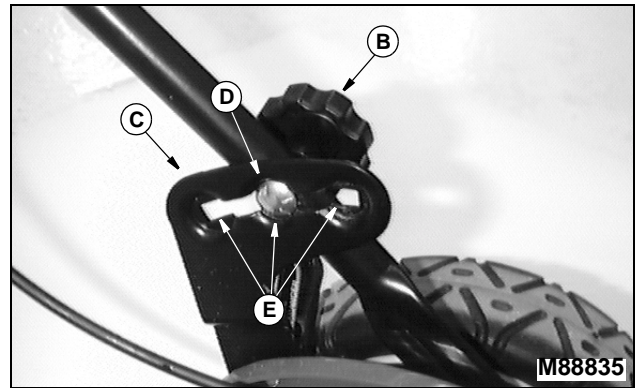

5. Rotate slotted bracket (C) to match a desirable height setting with hole in handle.
6. Install carriage bolt (D) from the inside through hole in slotted bracket (C) and through handle on each side of handle. Use same hole on each side.

NOTE: If handle height is not satisfactory, move handle to another hole and height position. Bolts must travel within slotted adjustment brackets and come to rest within one of the three height setting positions (E) before tightening.

7. Install and tighten knob (B) on each bolt. Both handle knobs should be positioned on the outside of the handles.

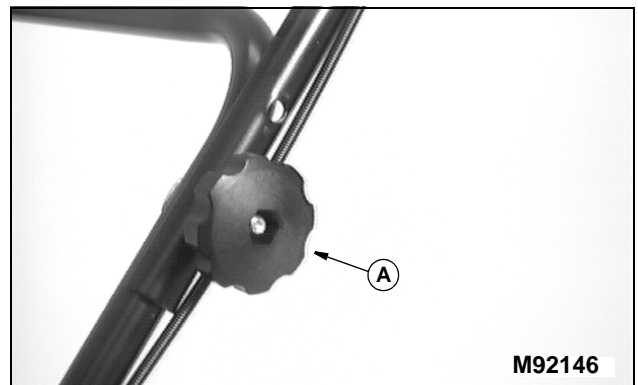

8. Pivot upper portion of handle assembly to a straight and aligning position. Hold handle and tighten knob (A) on each side.

Install Starter Rope

NOTE: To make installation of the starter rope onto the rope guide easier, hold the blade control lever against the handle while pulling the starter rope.

ASSEMBLY

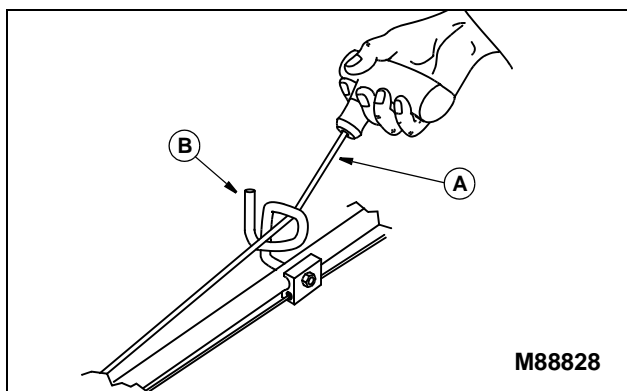

Pull and install starter rope (A) onto rope guide (B) mounted on the right side of the handle.

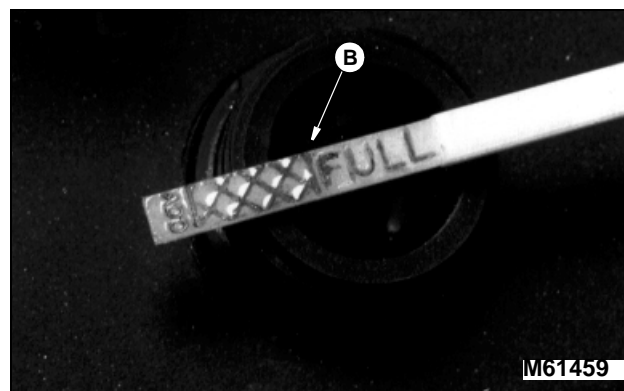

- Check oil level. Oil should be to the FULL mark (B). If not, add oil.

Add Engine Oil

IMPORTANT: Avoid damage! ENGINE IS SHIPPED WITHOUT OIL.

You MUST add oil before running the engine. See Service section for correct oil application.

1. Park mower on a level surface.



2. Turn oil dipstick (A) 1/4 turn to the left. Remove dipstick.
3. Add 0.47 L (16 oz) oil through dipstick filler tube.
4. Check oil level:
 - Install dipstick. Turn dipstick 1/4 turn right to tighten.
 - Remove dipstick.

Install Grass Bag



CAUTION: Avoid injury! DO NOT operate mower unless mulch guard, side discharge chute or grass bag and bagging chute are in place.

Bagging chute MUST be removed and mulch guard secured in place when grass bag is not being used.

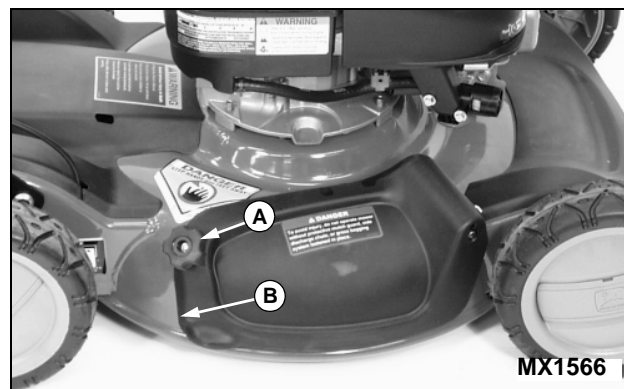

1. Remove mulch guard knob (A).
2. Lift and hold spring loaded mulch guard (B) up.
3. Install bagging chute:

ASSEMBLY

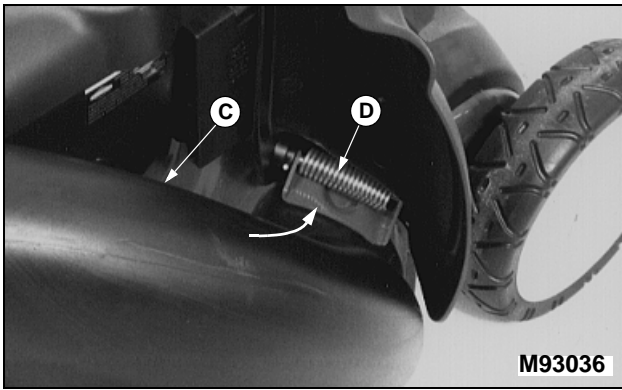

- Slide bagging chute (C) into position under the mulch guard mounting bracket (D).

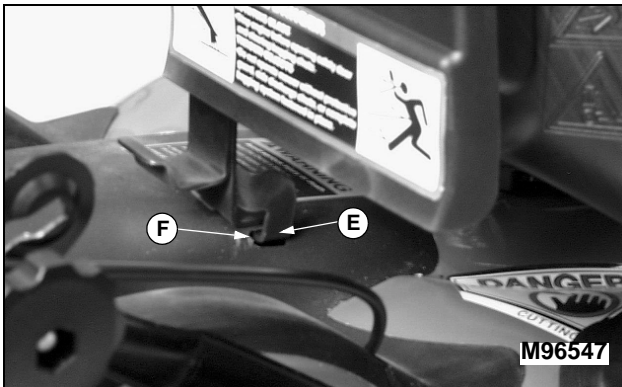

- Insert bagging chute tab (E) into rear mower shield slot (F).



- Reinstall and tighten knob (A).

NOTE: Doors (H) on grass bag must be closed prior to installation onto the bagging chute.



4. Hang grass bag on lower handlebar.
5. Open spring loaded bagging chute safety door (I).
6. Install grass bag onto bagging chute.

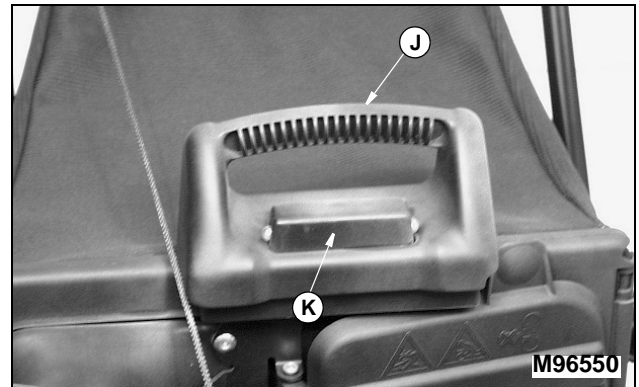

- Grass bag handle (J) should “snap” down onto tab (K).

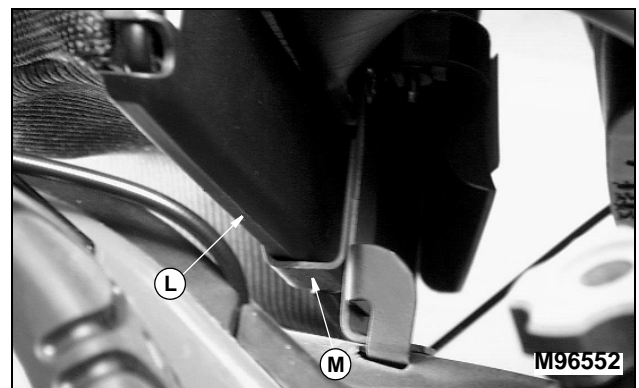

- Make sure front of grass bag (L) rests in bagging chute bracket (M).

ASSEMBLY

Test Mower

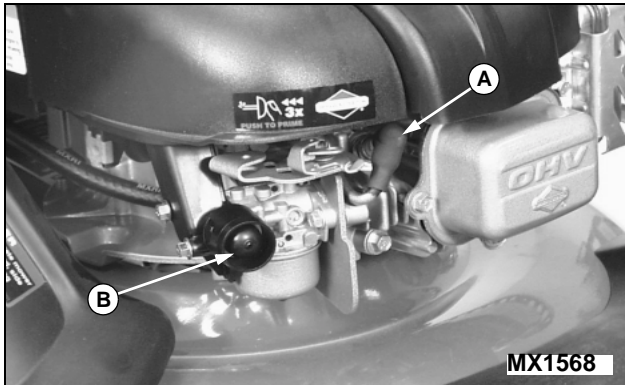

1. Verify that spark plug wire (A) is attached to spark plug.
2. Put enough fuel in fuel tank to test mower operation.
3. Press primer bulb (B) three times to prime engine.

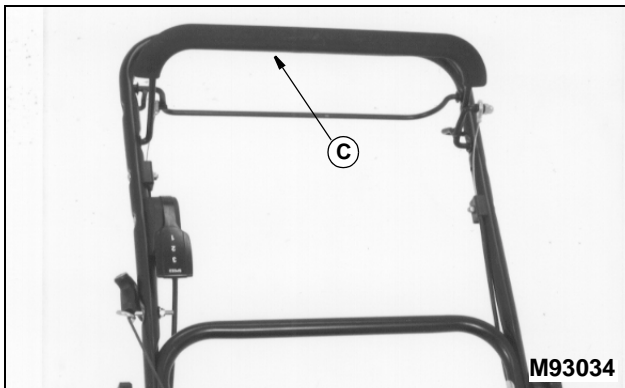

4. Hold blade control lever (C) against handle.
5. Start engine and check mower operation. (See Operating section.)

SPECIFICATIONS

Engine

| | |
|-------------------------|-----------------------|
| Manufacturer | Briggs & Stratton |
| Model | 121602 |
| Horsepower | 4.8 kW (6.5 hp) |
| Cycle | 4 |
| Valve Type | Over Head Valve (OHV) |
| Displacement | 190 cc (11.6 cu in) |
| Choke | Primer Bulb |
| Starter | Recoil |
| Throttle Control | Fixed Speed |
| Lubrication | Splash |
| Spark Plug | Champion RC12YC |
| Spark Plug Gap | 0.51 mm (.020 in) |
| Spark Plug Torque | 20 N•m (15 lb-ft) |

Travel Speed Range

SP6211

| | |
|------------------|--------------------|
| First Gear | 3.9 km/h (2.4 mph) |
|------------------|--------------------|

SP6213

| | |
|-------------------|--------------------|
| First Gear | 3.1 km/h (1.9 mph) |
| Second Gear | 3.9 km/h (2.4 mph) |
| Third Gear | 5.0 km/h (3.1 mph) |

Capacities

| | |
|------------------|----------------|
| Fuel | 1.5 L (1.6 qt) |
| Engine Oil | 0.6 L (20 oz) |

Machine Specifications

| | |
|-------------------------------|-------------------|
| Deck Material | Steel |
| Adjustable Handle | Standard |
| Rear Grass Bag | Standard |
| Side Discharge Chute | Standard |
| Mulching | Standard |
| Mower Blade Bolt Torque | 75 N•m (55 lb-ft) |
| Safety System | Zone Start |

SPECIFICATIONS

Dimensions

Wheel Size 8.75 x 2.25

Mower Weight without Attachments

•SP6211 36.7 kg (81 lb)

•SP6213 38.6 kg (85 lb)

Cutting Height Range 2.5-10.2 cm (1-4 in)

Cutting Width 53.3 cm (21 in)

Recommended Lubricants

Fuel See Filling Fuel Tank in the Service section.

Engine Oil TORQ-GARD SUPREME® (SAE 30 or SAE 10W-30)

Grease John Deere MOLY HIGH TEMPERATURE EP GREASE

..... John Deere HIGH TEMPERATURE EP GREASE

..... John Deere GREASE GARD™

(Specifications and design subject to change without notice)

WARRANTY

LIMITED WARRANTY FOR NEW SCOTTS BRAND PRODUCTS

Manufactured by John Deere
(U.S. Only)

A. GENERAL PROVISIONS - The warranties described below are provided by John Deere Company ("John Deere") to the original purchasers of new Scotts Brand Products Manufactured by John Deere. Under these warranties, John Deere will repair or replace, at its option, any covered part which is found to be defective in material or workmanship during the applicable warranty term. Warranty service must be performed by a dealer or service center authorized by John Deere to service the type of product involved, which will use only new or remanufactured parts or components furnished by John Deere. Warranty service will be performed without charge to the purchaser for parts or labor. The purchaser will be responsible, however, for any service call and/or transportation of product to and from the dealer's or service center's place of business, for any premium charged for overtime labor requested by the purchaser and for any service and/or maintenance not directly related to any defect covered under the warranties below.

B. WHAT IS WARRANTED - All parts of any new Scotts Brand Product Manufactured by John Deere, except batteries, are warranted for the number of months or operating hours specified below. Warranty statements required by law covering engine emission-related parts and components, are found in the Operator's Manual delivered with the machine.

| EQUIPMENT USE | WARRANTY TERM |
|---|---------------|
| 1) IN RESIDENTIAL (Private Homeowner) APPLICATION | 24 Months |
| 2) IN ANY OTHER APPLICATION | 90 Days |

Each warranty term begins on the date of product sale to the purchaser.

C. WHAT IS NOT WARRANTED - JOHN DEERE IS NOT RESPONSIBLE FOR THE FOLLOWING: (1) Used products; (2) Any product that has been altered or modified in ways not approved by John Deere; (3) Depreciation or damage caused by normal wear, lack of reasonable and proper maintenance, failure to follow operating instructions, misuse, lack of proper protection during storage or accident; (4) Normal maintenance parts and service.

D. SECURING WARRANTY SERVICE - To secure warranty service, the purchaser must (1) report the product defect to an authorized dealer and request repair within the applicable warranty term, (2) present evidence of the warranty start date, and (3) make the product available to the dealer or service center within a reasonable period of time.

E. LIMITATION OF IMPLIED WARRANTIES AND OTHER REMEDIES - SCOTTS BRAND PRODUCTS MANUFACTURED BY JOHN DEERE - to the extent permitted by law, neither John Deere nor any company affiliated with it makes any warranties, representations, or promises as to the quality, performance or freedom from defect of the Scotts Brand Products Manufactured by John Deere covered by this warranty. IMPLIED WARRANTIES OF MERCHANTABILITY AND FITNESS FOR A PARTICULAR PURPOSE, TO THE EXTENT APPLICABLE, SHALL BE LIMITED IN DURATION TO THE APPLICABLE PERIOD OF WARRANTY SET FORTH ON THIS PAGE. THE PURCHASER'S ONLY REMEDIES IN CONNECTION WITH THE BREACH OR PERFORMANCE OF ANY WARRANTY ON THE SCOTTS BRAND PRODUCTS MANUFACTURED BY JOHN DEERE ARE THOSE SET FORTH ON THIS PAGE. IN NO EVENT WILL THE DEALER, JOHN DEERE OR ANY COMPANY AFFILIATED WITH JOHN DEERE BE LIABLE FOR INCIDENTAL OR CONSEQUENTIAL DAMAGES. (Note: Some states do not allow limitations on how long an implied warranty lasts or the exclusion or limitation of incidental or consequential damages so the above limitations and exclusions may not apply to you.) This warranty gives you specific

legal rights, and you may also have other rights which vary from state to state.

F. NO DEALER WARRANTY - THE SELLING DEALER MAKES NO WARRANTY OF ITS OWN AND THE DEALER HAS NO AUTHORITY TO MAKE ANY REPRESENTATION OR PROMISE ON BEHALF OF JOHN DEERE, OR TO MODIFY THE TERMS OR LIMITATIONS OF THIS WARRANTY IN ANY WAY.

G. FAILURE DUE TO IMPROPER SET-UP IS NOT COVERED UNDER WARRANTY.

H. If further information is desired, contact a servicing dealer. For the location of servicing dealers in your area call 1-877-356-3698.

LIMITED WARRANTY FOR NEW SCOTTS BRAND PRODUCTS

Manufactured by John Deere
(Canada Only)

A. GENERAL PROVISIONS - The warranties described below are provided by John Deere Limited ("John Deere") to the original purchasers of new Scotts Brand Products Manufactured by John Deere. Under these warranties, John Deere will repair or replace, at its option, any part covered under these warranties which is found to be defective in material or workmanship during the applicable warranty term. Warranty service must be performed by a dealer or service center authorized by John Deere to service the type of product involved, which will use only new or remanufactured parts or components furnished by John Deere. Warranty service will be performed without charge to the purchaser for parts or labor. The purchaser will be responsible, however, for any service call and/or transportation of product to and from the dealer's or service center's place of business, except where prohibited by law, for any premium charged for overtime labor requested by the purchaser and for any service and/or maintenance not directly related to any defect covered under the warranties below.

B. WHAT IS WARRANTED - Subject to paragraph C below, all parts of any new Scotts Brand Product Manufactured by John Deere, except batteries, are warranted for the number of months or days specified below. Warranty statements required by law covering engine emission-related parts and components, if any, are found in the Operator's Manual delivered with the product.

| EQUIPMENT USE | WARRANTY TERM |
|---|---------------|
| 1) IN RESIDENTIAL (Private Homeowner) APPLICATION | 24 Months |
| 2) IN ANY OTHER APPLICATION | 90 Days |

Each warranty term begins on the date of product sale to the purchaser.

C. WHAT IS NOT WARRANTED - JOHN DEERE IS NOT RESPONSIBLE FOR THE FOLLOWING: (1) Used products; (2) Any product that has been altered or modified in ways not approved by John Deere; (3) Depreciation or damage caused by normal wear, lack of reasonable and proper maintenance, failure to follow operating instructions, misuse, lack of proper protection during storage or accident; (4) Normal maintenance parts and service

D. SECURING WARRANTY SERVICE - To secure warranty service, the purchaser must (1) report the product defect to an authorized dealer and request repair or replacement within the applicable warranty term, (2) present evidence of the warranty start date, and (3) make the product available to the dealer or service center within a reasonable period of time.

E. LIMITATION OF IMPLIED WARRANTIES AND OTHER REMEDIES - SCOTTS BRAND PRODUCTS MANUFACTURED BY JOHN DEERE - TO THE EXTENT PERMITTED BY LAW, NEITHER JOHN DEERE NOR ANY

WARRANTY

COMPANY AFFILIATED WITH IT MAKES ANY WARRANTIES, REPRESENTATIONS, CONDITIONS OR PROMISES RESPECTING THE SCOTTS BRAND PRODUCTS MANUFACTURED BY JOHN DEERE AND COVERED BY THIS WARRANTY OTHER THAN THOSE LISTED ABOVE. THIS EXCLUSION INCLUDES FUNDAMENTAL TERMS, REPRESENTATIONS, CONDITIONS AND WARRANTIES WHICH MAY BE EXPRESSED OR IMPLIED, VERBAL OR OTHERWISE, INCLUDING IMPLIED OR STATUTORY CONDITIONS OR WARRANTIES OF MERCHANTABILITY AND FITNESS, WHETHER PURSUANT TO THE SALE OF GOODS ACT OR ANY OTHER STATUTE OF ANY PROVINCE OR OTHERWISE, EXCEPT WHERE SUCH IMPLIED OR STATUTORY CONDITIONS OR WARRANTIES MAY NOT BE EXCLUDED BY LAW.

F. REMEDIES EXCLUSIVE - THE PURCHASER'S ONLY REMEDIES IN CONNECTION WITH THE BREACH OR PERFORMANCE OF ANY WARRANTY ON THE SCOTTS BRAND PRODUCTS MANUFACTURED BY JOHN DEERE ARE THOSE SET FORTH IN THIS WARRANTY EXCEPT FOR THOSE REMEDIES PROVIDED BY LAW WHICH MAY NOT BE EXCLUDED. IN NO EVENT WILL THE DEALER, JOHN DEERE OR ANY COMPANY AFFILIATED WITH JOHN DEERE, BE LIABLE FOR INCIDENTAL OR CONSEQUENTIAL DAMAGES OR INJURIES OR BE LIABLE FOR DAMAGES SUFFERED BY THE PURCHASER AS A RESULT OF FUNDAMENTAL BREACHES OF CONTRACT OR BREACHES OF FUNDAMENTAL TERMS. The limitations of liability contained in this warranty shall only be effective to the extent permitted by law. This warranty gives you specific legal rights and you may also have other rights which vary from jurisdiction to jurisdiction.

G. NO DEALER WARRANTY - EXCEPT FOR WARRANTIES WHICH MAY NOT BE EXCLUDED BY LAW, THE SELLING DEALER MAKES NO WARRANTY OF ITS OWN AND THE SELLING DEALER HAS NO AUTHORITY TO MAKE ANY REPRESENTATION OR PROMISE ON BEHALF OF JOHN DEERE, OR TO MODIFY THE TERMS OR LIMITATIONS OF THIS WARRANTY IN ANY WAY.

H. FAILURE DUE TO IMPROPER SET-UP IS NOT COVERED UNDER WARRANTY.

I. If further information is desired, contact a servicing dealer. For the location of servicing dealers in your area call 1-877-864-2295.

Tire Warranty

John Deere warranty applies for tires available through the John Deere parts system. For tires not available through the John Deere parts system, the tire manufacturer's warranty applicable to your machine may not apply outside the U.S. (See your John Deere dealer for specific information.)

Limited Engine Warranty

FEDERAL AND CALIFORNIA EMISSION CONTROL DEFECTS WARRANTY STATEMENT

YOUR WARRANTY RIGHTS AND OBLIGATIONS

The United States Environmental Protection Agency (EPA), the California Air Resources Board (CARB) and Deere & Company (John Deere) are pleased to explain the emission control system warranty on your 1995 and later utility or lawn and garden equipment engine. In California new utility and lawn and garden equipment engines must be designed, built and equipped to meet the State's stringent anti-smog standards. In other states, new 1997 and later model year equipment engines must be designed, built and equipped, at the time of sale, to meet the U.S. EPA regulations for small non-road engines. The engine must be free from defects in materials and workmanship which cause it to fail to conform with U.S. EPA standards for the first two years of engine use from the date of sale to the ultimate purchaser. John Deere must warrant the emission

control system on your utility or lawn and garden equipment engine for the periods of time listed below provided there has been no abuse, neglect or improper maintenance of your utility or lawn and garden equipment engine.

Your emission control system may include parts such as the carburetor or fuel-injection system, the ignition system, and catalytic converter. Also included may be hoses, belts, connectors and other emission related assemblies.

Where a warrantable condition exists, John Deere will repair your utility or lawn and garden equipment engine at no cost to you including diagnosis, parts and labor.

MANUFACTURER'S WARRANTY COVERAGE:

In California, the 1995 and later utility and lawn and garden equipment engines are warranted for two years. In other states, 1997 and later model year equipment engines are warranted for two years. If any emission related part on your engine is defective, the part will be repaired or replaced by John Deere.

OWNER'S WARRANTY RESPONSIBILITIES

As the utility or lawn and garden equipment engine owner, you are responsible for the performance of the required maintenance listed in your owners manual. John Deere recommends that you retain all receipts covering maintenance on your utility or lawn and garden equipment engine, but John Deere cannot deny warranty solely for lack of receipts or for your failure to ensure the performance of all scheduled maintenance.

As the utility or lawn and garden equipment engine owner, you should however be aware that John Deere may deny you warranty coverage if your utility or lawn and garden equipment engine or a part has failed due to abuse, neglect, improper maintenance or unapproved modifications.

You are responsible for presenting your utility or lawn and garden equipment engine to an authorized John Deere Commercial and Consumer Equipment Retailer as soon as a problem exists. The warranty repairs should be completed in a reasonable amount of time, not to exceed 30 days.

If you have any questions regarding your warranty rights and responsibilities, you should contact your John Deere Commercial and Consumer Equipment Retailer, or the John Deere Customer Communications Center, 1-800-537-8233.

JOHN DEERE EMISSION CONTROL SYSTEM WARRANTY COVERAGE

LENGTH OF WARRANTY COVERAGE

John Deere warrants to the initial owner and each subsequent purchaser that the lawn and garden equipment engine is:

- Designed, built and equipped so as to conform with all applicable regulations adopted by the California Air Resources Board (CARB) pursuant to its authority in Chapters 1 and 2, Part 5, Division 26 of the Health and Safety Code for 1995 and later equipment engines, and all applicable regulations of the United States Environmental Protection Agency (EPA) for 1997 and later equipment engines; and
- Free from defects in materials and workmanship which can cause the failure of an emission warranted part for a period of two years after the engine is delivered to the initial retail purchaser. John Deere is liable for damages to other engine components caused by the failure of a warranted part during the warranty period. If any emission related part on your engine is defective, the part will be repaired or replaced by John Deere.

WARRANTY

WARRANTED PARTS

Coverage under this warranty extends only to the parts listed below (the emission control system parts) to the extent these parts were present on the engine purchased.

| | |
|---|--|
| Fuel Metering System: | Fuel Metering System: |
| | Carburetor and internal parts (or fuel injection system). |
| | Cold start enrichment system. |
| | Air/fuel ratio feedback and control system. |
| Air Induction System: | Air Cleaner |
| | Controlled hot air intake system. |
| | Intake manifold. |
| Particulate Controls: | Traps, filters, precipitators, and any other device used to capture particulate emissions. |
| Exhaust Gas Recirculation (EGR) System: | EGR valve body and carburetor spacer if applicable. |
| | EGR rate feedback and control system. |
| Ignition System: | Spark plugs. |
| | Magneto or electronic ignition system. |
| | Spark advance/retard system. |
| Air Injection System: | Air pump or pulse valve. |
| | Valves affecting distribution of flow. |
| | Distribution manifold. |
| Catalyst or Thermal Reactor System: | Catalytic converter. |
| | Thermal reactor. |
| | Exhaust manifold. |
| Miscellaneous Items Used in Above Systems | Vacuum, temperature, and time sensitive valves and switches. |
| | Electronic controls. |
| | Hoses, belts, connectors, and assemblies. |

Since emission related parts may vary slightly from model to model, certain models may not contain all of these parts and certain models may contain functionally equivalent parts.

WARRANTY SERVICE AND CHARGES

Warranty service shall be provided during customary business hours at any authorized John Deere Commercial and Consumer Equipment Retailer located within the United States of America. Repair or replacement of any warranted part will be performed at no charge to the owner, including diagnostic labor which leads to the determination that a warranted part is defective, if the diagnostic work is performed at an authorized John Deere Commercial and Consumer Equipment Retailer. Any parts replaced under this warranty shall become the property of John Deere.

MAINTENANCE WARRANTY COVERAGE

- a) Any warranted part which is not scheduled for replacement as required maintenance shall be warranted as to defects for the warranty period. Any such part repaired or replaced under the warranty shall be warranted for the remaining warranty period.
- b) Any warranted part which is scheduled only for regular inspection to the effect of "repair or replace as necessary" shall be warranted as to defects for the warranty period. Any such part repaired or replaced under the warranty shall be warranted for the remaining warranty period.
- c) Any warranted part which is scheduled for replacement as required maintenance shall be warranted as to defects only for the period of time up

to the first scheduled replacement for that part. Any such part repaired or replaced under the warranty shall be warranted for the remainder of the period prior to the first scheduled replacement point for that part.

d) Normal maintenance, replacement or repair of emission control devices and systems, which are being done at the customers expense, may be performed by any repair establishment or individual; however, warranty repairs must be performed by an authorized John Deere Commercial and Consumer Equipment Retailer.

e) Any replacement part that is equivalent in performance and durability may be used in the performance of any non-warranty maintenance or repairs, and shall not reduce the warranty obligations of John Deere.

CONSEQUENTIAL WARRANTY COVERAGE

Warranty coverage shall extend to the failure of any engine components caused by the failure of any warranted part still under warranty.

LIMITATIONS

This Emission Control System Warranty shall NOT cover any of the following:

- a) Repair or replacement required as a result of (i) misuse or neglect, (ii) improper maintenance or unapproved modifications, (iii) repairs improperly performed or replacements improperly installed, (iv) use of replacement parts or accessories not conforming to John Deere specifications which adversely affect performance and/or durability, (v) alterations or modifications not recommended or approved in writing by John Deere.
- b) Replacement parts, other services and adjustments necessary for normal maintenance.
- c) Transportation to and from the John Deere Commercial and Consumer Equipment Retailer, or service calls made by the Retailer.

LIMITED LIABILITY

a) The liability of John Deere under this Emission Control System Warranty is limited solely to the remedying of defects in materials or workmanship. This warranty does not cover inconvenience or loss of use of the utility or lawn and garden equipment engine or transportation of the engine to or from the John Deere Commercial and Consumer Equipment Retailer. JOHN DEERE SHALL NOT BE LIABLE FOR ANY OTHER EXPENSE, LOSS, OR DAMAGE, WHETHER DIRECT, INCIDENTAL, CONSEQUENTIAL (EXCEPT AS LISTED ABOVE UNDER "COVERAGE") OR EXEMPLARY ARISING IN CONNECTION WITH THE SALE OR USE OF OR INABILITY TO USE THE UTILITY OR LAWN AND GARDEN ENGINE FOR ANY OTHER PURPOSE.

b) NO EXPRESS EMISSION CONTROL SYSTEM WARRANTY IS GIVEN BY JOHN DEERE WITH RESPECT TO THE ENGINE EXCEPT AS SPECIFICALLY SET FORTH IN THIS DOCUMENT. ANY EMISSION CONTROL SYSTEM WARRANTY IMPLIED BY LAW, INCLUDING ANY WARRANTY OF MERCHANTABILITY OR FITNESS FOR A PARTICULAR PURPOSE, IS EXPRESSLY LIMITED TO THE EMISSION CONTROL SYSTEM WARRANTY TERMS SET FORTH IN THIS DOCUMENT.

c) No dealer is authorized to modify this Federal, California and John Deere Emission Control System Warranty.

LEGAL RIGHTS

This Warranty gives you specific legal rights. You may also have other rights in the State of California for 1995 and later equipment engines and in other states for 1997 and later equipment engines.

THIS FEDERAL AND CALIFORNIA EMISSION CONTROL SYSTEM WARRANTY IS IN ADDITION TO THE JOHN DEERE LIMITED ENGINE WARRANTY.

INDEX

A

| | |
|--------------------------------|----|
| Adjusting Carburetor | 14 |
| Adjusting Throttle Cable | 14 |
| Axles, Lubricate Mower | 21 |

B

| | |
|--|----|
| Bagging and Composting | 10 |
| Bagging Tips | 10 |
| Balance and Install Blade | 23 |
| Belt and Transmission Area, Cleaning | 18 |
| Blade, Check | 22 |
| Blade, Install and Balance | 23 |
| Blade, Sharpening | 22 |
| Bushings, Lubricate Drive Shaft Hub | 21 |

C

| | |
|---|----|
| Capacities | 33 |
| Carburetor, Adjusting | 14 |
| Certification Label | 2 |
| Chute, Using Side Discharge | 9 |
| Cleaning Belt and Transmission Area | 22 |
| Composting, Bagging and | 10 |
| Controls, Engine | 5 |
| Controls, Handle | 5 |
| Controls, Handle and Cutting Height | 5 |
| Cooling Fins, Cleaning | 17 |
| Cutting Height, Adjust | 5 |

D

| | |
|-----------------------------------|----|
| Dealer Set-up | 29 |
| Discharge Chute, Using Side | 9 |

E

| | |
|---|----|
| Element, Paper | 16 |
| Emergency Stopping | 8 |
| Engine and Fuel Storage, Preparing | 27 |
| Engine Oil | 14 |
| Engine Oil Level, Checking | 14 |
| Engine Oil, Changing | 15 |
| Engine Warranty Maintenance Statement | 14 |
| Engine, Add Oil | 30 |

F

| | |
|-------------------------------|----|
| Fuel Cap Vent, Cleaning | 24 |
|-------------------------------|----|

G

| | |
|--------------------------|----|
| Grass Bag, Install | 30 |
|--------------------------|----|

H

| | |
|-----------------------------|----|
| Handle Height, Adjust | 6 |
| Handles, Fold | 27 |
| Handles, Unfold | 29 |

I

| | |
|----------------------------------|----|
| Interval Chart for Service | 13 |
|----------------------------------|----|

L

| | |
|------------------|----|
| Lubricants | 34 |
|------------------|----|

M

| | |
|----------------------------------|----|
| Mower, Remove from Storage | 28 |
| Mower, Test | 32 |
| Mowing Tips | 9 |
| Mulching Tips | 10 |

O

| | |
|----------------------------------|----|
| Oil Level, Checking Engine | 14 |
| Oil, Add Engine | 30 |
| Oil, Changing Engine | 15 |
| Oil, Engine | 14 |

P

| | |
|--------------------------------|----|
| Paper Element, Replacing | 16 |
| Part Numbers | 12 |
| Parts Catalog | 12 |

S

| | |
|--|----|
| Safety Labels | 1 |
| Safety, Maintenance | 3 |
| Safety, Operating | 2 |
| Scalping, To Avoid | 10 |
| Service Intervals | 13 |
| Service Record | 42 |
| Sharpening Blade | 22 |
| Side Discharge Chute, Using | 9 |
| Spark Plug, Cleaning and Gapping | 17 |
| Specifications | 33 |
| Speeds, Travel | 8 |
| Stopping Engine | 8 |
| Storage, Preparing Fuel and Engine for; Fuel Storage ... | 27 |

T

| | |
|-------------------------------------|----|
| Technical Manual | 12 |
| Transmission Cable Adjustment | 20 |
| Troubleshooting Chart | 25 |

W

| | |
|--|----|
| Warranty Maintenance Statement, Engine | 14 |
| Waste Products, Handling | 4 |

QUALITY STATEMENT

Please do not return this product to the store where you purchased it.



Your Scotts product, designed and built by John Deere, is more than just a purchase, it's an investment in quality. That quality goes beyond our equipment to your dealer's parts and service support.

That's why John Deere has initiated a process to handle your questions or problems, should they arise. If you have questions or problems with your new product, please follow the steps below. To locate your nearest authorized Scotts servicing dealer, please call toll free 1-877-864-2295.

Step 1

Refer to your operator's manual

- A. It has many illustrations and detailed information on the safe and proper operation of your equipment.
- B. It gives troubleshooting procedures, and specification information.
- C. It gives ordering information for parts catalogs, service and technical manuals.
- D. If your questions are not answered in the operator's manual, then go to Step 2.

Step 2

Contact your dealer

- A. Your authorized Scotts servicing dealer has the responsibility, authority, and ability to answer questions, resolve problems, and fulfill your parts and service needs.
- B. First, discuss your questions or problems with your dealer's trained parts and service staff.
- C. If the parts and service people are unable to resolve your problem, see the dealership manager or owner.
- D. If your questions or problems are not resolved by the dealer, then go to Step 3.

Step 3

Call the Customer Communications Center

- A. Your authorized Scotts servicing dealer is the most efficient source in addressing any concern, but if you are not able to resolve your problem after checking your operator's manual and contacting your dealer, call the Customer Communications Center.
- B. For prompt, effective service, please have the following ready before you call:
 - The name of the dealer with whom you've been working.
 - Your equipment model number.
 - Number of hours on machine (if applicable).
 - Your 13-digit serial number which you recorded on the inside front cover of this manual.
 - If the problem is with an attachment, your attachment identification number.
- C. Then call 1-877-864-2295 and our advisor will work with your dealer to investigate your concern.

Free Manuals Download Website

<http://myh66.com>

<http://usermanuals.us>

<http://www.somanuals.com>

<http://www.4manuals.cc>

<http://www.manual-lib.com>

<http://www.404manual.com>

<http://www.luxmanual.com>

<http://aubethermostatmanual.com>

Golf course search by state

<http://golfingnear.com>

Email search by domain

<http://emailbydomain.com>

Auto manuals search

<http://auto.somanuals.com>

TV manuals search

<http://tv.somanuals.com>