

**APPROVED**

*By adamss at 11:30 am, Oct 12, 2007*

**SERVICE INSTRUCTIONS**

1. Do NOT attempt to repair or adjust any electrical or mechanical functions on this unit. Doing so will void the Warranty.
2. If you need to exchange the unit, please return it in its original carton, with a sales receipt, to the store where you purchased it. If you are returning the unit more than 30 days after the date of purchase, please see the enclosed Warranty.
3. If you have any questions or comments regarding this unit's operation or believe any repair is necessary, please write to our Consumer Service Department or visit our website at [www.seal-a-meal.com](http://www.seal-a-meal.com).

SUNBEAM PRODUCTS, INC. DOING BUSINESS AS JARDEN CONSUMER SOLUTIONS  
 303 NELSON AVENUE  
 NEOSHO, MO 64850

**1 YEAR LIMITED WARRANTY**

Sunbeam Products, Inc. doing business as Jarden Consumer Solutions or if in Canada, Sunbeam Corporation (Canada) Limited doing business as Jarden Consumer Solutions, (collectively "JCS") warrants that for a period of one year from the date of purchase, this product will be free from defects in material and workmanship. JCS, at its option, will repair or replace this product or any component of the product found to be defective during the warranty period. Replacement will be made with a new or remanufactured product or component. If the product is no longer available, replacement may be made with a similar product of equal or greater value. This is your exclusive warranty. Do NOT attempt to repair or adjust any electrical or mechanical functions on this product. Doing so will void this warranty.

This warranty is valid for the original retail purchaser from the date of initial retail purchase and is not transferable. Keep the original sales receipt. Proof of purchase is required to obtain warranty performance. JCS dealers, service centers, or retail stores selling JCS products do not have the right to alter, modify or in any way change the terms and conditions of this warranty.

This warranty does not cover normal wear of parts or damage resulting from any of the following: negligent use or misuse of the product, use on improper voltage or current, use contrary to the operating instructions and disassembly, repair or alteration by anyone other than JCS or an authorized JCS service center. Further, the warranty does not cover: Acts of God, such as fire, flood, hurricanes and tornadoes.

What are the limits on JCS's Liability?  
 JCS shall not be liable for any incidental or consequential damages caused by the breach of any express, implied or statutory warranty or condition.

Except to the extent prohibited by applicable law, any implied warranty or condition of merchantability or fitness for a particular purpose is limited in duration to the duration of the above warranty.

JCS disclaims all other warranties, conditions or representations, express, implied, statutory or otherwise.

JCS shall not be liable for any damages of any kind resulting from the purchase, use or misuse of, or inability to use the products including incidental, special, consequential or similar damages or loss of profits, or for any breach of contract, fundamental or otherwise, or for any claim brought against purchaser by any other party.

Some provinces, states or jurisdictions do not allow the exclusion or limitation of incidental or consequential damages or limitations on how long an implied warranty lasts, so the above limitations or exclusions may not apply to you.

This warranty gives you specific legal rights, and you may also have other rights that vary from province to province, state to state or jurisdiction to jurisdiction.

How to Obtain Warranty Service

In the U.S.A.

If you have any question regarding this warranty or would like to obtain warranty service, please call 1 (800) 557-4825 and a convenient service center address will be provided to you. Visit [www.seal-a-meal.com](http://www.seal-a-meal.com) for more information.

In Canada

If you have any question regarding this warranty or would like to obtain warranty service, please call 1 (800) 557-4825 and a convenient service center address will be provided to you. Visit [www.seal-a-meal.com](http://www.seal-a-meal.com) for more information.

Canisters, containers, bags, rolls, and other accessories: JCS makes no warranty, express or implied, written or oral, including that of merchantability or fitness for any particular purpose with respect to canisters, containers, bags, rolls, and any other accessories.

In the U.S.A., this warranty is offered by Sunbeam Products, Inc. doing business as Jarden Consumer Solutions located in Boca Raton, Florida 33431. In Canada, this warranty is offered by Sunbeam Corporation (Canada) Limited doing business as Jarden Consumer Solutions located at 20 B Hereford Street, Brampton, Ontario L6Y 0M1. If you have any other problem or claim in connection with this product, please write our Consumer Service Department. **PLEASE DO NOT RETURN THIS PRODUCT TO ANY OF THESE ADDRESSES OR TO THE PLACE OF PURCHASE.**

**Seal a Meal**  
 Vacuum Food Storage System

**Vacuum Food Sealer  
 Space Saving Design**

**Vacuum Food Storage System  
 Reference Guide**



*Preserves the taste and  
 nutritional value of stored foods!*

**[www.seal-a-meal.com](http://www.seal-a-meal.com)**

**RIVAL Seal a Meal**  
 Vacuum Food Storage System

**[www.seal-a-meal.com](http://www.seal-a-meal.com)**

© 2007 Sunbeam Products, Inc. doing business as Jarden Consumer Solutions. All rights reserved. Distributed by Sunbeam Products, Inc. doing business as Jarden Consumer Solutions, Boca Raton, Florida 33431.

Printed in China

VS230/VS240/9100060001424  
 VS230/24007EM1

**READ AND SAVE THESE INSTRUCTIONS**

**VS230/VS240**

## IMPORTANT SAFEGUARDS

When using electrical appliances, basic safety precautions should always be followed, including the following:

1. Read the instructions carefully.
2. Do not use the Vacuum Food Sealer on wet or hot surfaces, or near a heat source.
3. Always use the Vacuum Food Sealer on a level flat surface.
4. Do not immerse any part of the Vacuum Food Sealer, power cord or plug into water or other liquid.
5. To disconnect, unplug the power cord from the electrical outlet. Do not disconnect by pulling on the cord. Always unplug the Vacuum Food Sealer before cleaning.
6. Do not operate the Vacuum Food Sealer with a damaged power cord or plug.
7. Do not operate the Vacuum Food Sealer if it malfunctions or is in any way damaged. If the cord or the machine is damaged, it must be returned to an authorized service center. See warranty for more information.
8. Use the Vacuum Food Sealer only for its intended use.
9. Close supervision is required when this product is used near children.
10. This appliance should not be operated by children.
11. Do not allow the Vacuum Food Sealer to be used as a toy.
12. The Vacuum Food Sealer is not for commercial use. If sealing more than 30 bags or canister in a row, wait at least 25 minutes before continuing to use your vacuum food sealer.

## SAVE THESE INSTRUCTIONS

This appliance is for **HOUSEHOLD USE ONLY**.

Do not attempt to service this product. Service should be performed by an authorized service representative.

A short power-supply cord is provided to reduce the risk resulting from becoming entangled in or tripping over a longer cord. Extension cords are available and are not prohibited from being used when care is exercised in their use. When an extension cord is used the marked electrical rating of the extension cord shall be no less than the marked electrical rating of the appliance. The longer cord shall be arranged so that it does not drape over the counter-top or tabletop where it is capable of being tripped over, snagged, or pulled on unintentionally, especially by children.

### POLARIZED PLUG



This appliance has a polarized plug (one blade is wider than the other). To reduce the risk of electric shock, this plug is intended to fit into a polarized outlet only one way. If the plug does not fit fully into the outlet, reverse the plug. If it still does not fit, contact a qualified electrician.

Do not attempt to modify the plug in any way. If the plug fits loosely into the AC outlet or if the AC outlet feels warm do not use that outlet.

## START ENJOYING THE BENEFITS OF YOUR SEAL-A-MEAL® VACUUM FOOD STORAGE SYSTEM

Thank you for purchasing this Seal-a-Meal® Vacuum Sealer. Seal-a-Meal® products have been helping families save food, money and time for over 35 years. Now we are introducing the new Press/Hold and Release system.

With the new Press/Hold and Release system you firmly press down on the lid and when the Hands-Free Indicator Light illuminates you can remove your hands and let your vacuum sealer do the rest! The machine continues to vacuum and then seal the bag.

Your unit includes the following:

- Food Sealer
- Starter Bag Kit
- Accessory Hose
- Accessory Hose Adapter

By preparing foods and meals in advance and storing with the Seal-a-Meal® Vacuum Storage System, you save time and money.

## FEATURES AND BENEFITS

- **Integrated Bag Storage and Cutter** to make custom sized bags.
- **Moist Seal** setting extends the length of the sealing cycle to provide the securest seal when liquid is present.
- **Press/Hold and Release System** makes it easy to close the lid and start the vacuum function.
- **Vacuums and Seals** preserving the taste and nutritional value of stored foods.
- **Dishwasher Safe Drip Tray System** can be removed from your vacuum sealer and cleaned in the top rack of your dishwasher.
- **Accessory Port** allows vacuum packaging with accessories.
- **Hands-free Indicator Light** illuminates when it is safe to remove hands from the lid.
- **Sealing Indicator Light** illuminates when the appliance is sealing the bag.
- **Open/Cancel Button** cancels the vacuum and seal process or releases the lid once the vacuum and sealing process are complete.

## SEAL-A-MEAL® ACCESSORIES

- Seal-a-Meal® Vacuum Food Storage Canisters:
  - Stackable round canisters save space in the fridge or pantry.
  - Easy to use - Accessory Hose connects directly to lid
  - Dishwasher safe for easy cleaning
  - Protect delicate foods and more

Visit the Seal-a-Meal® web site at [www.seal-a-meal.com](http://www.seal-a-meal.com), for additional Hints and Tips, Questions and Answers, Recipes, and Updates.

## KNOW YOUR SEAL-A-MEAL® VACUUM FOOD STORAGE SYSTEM

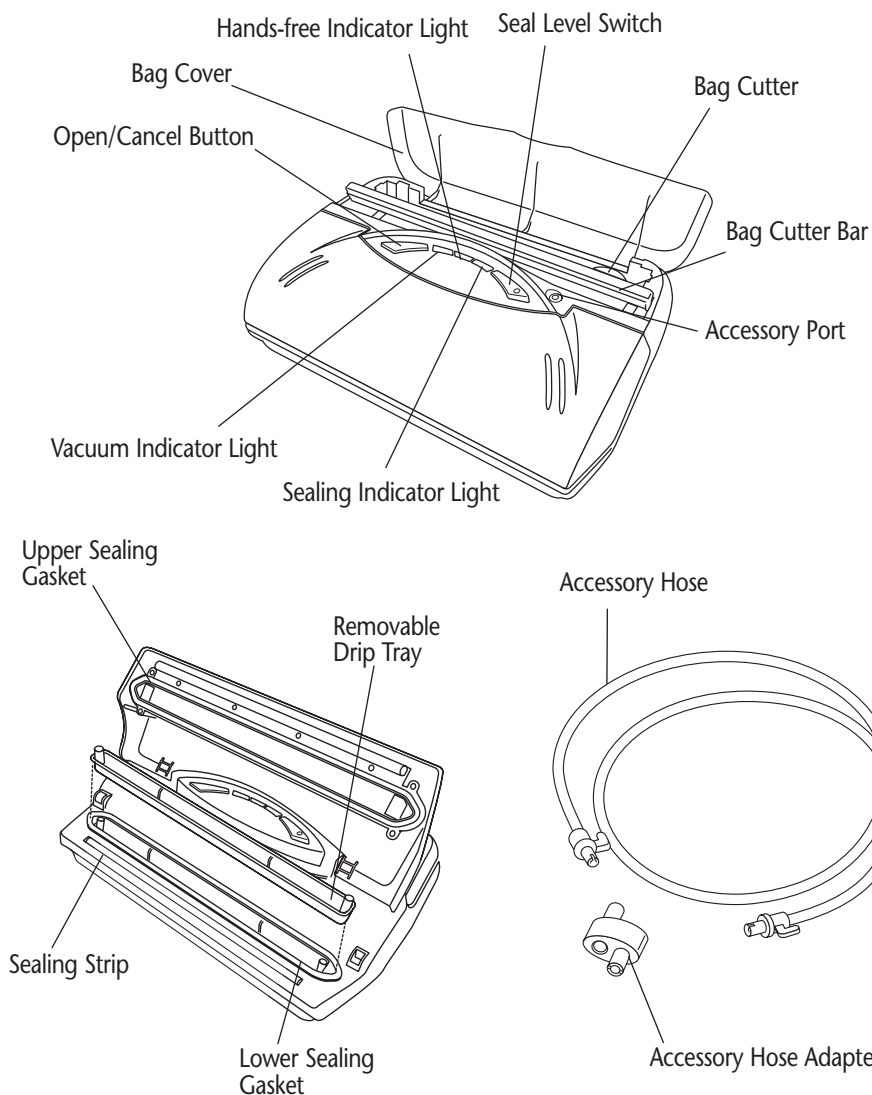

## PREPARING YOUR SEAL-A-MEAL® VACUUM FOOD STORAGE SYSTEM FOR USE

Carefully unpack your Seal-a-Meal® Vacuum Sealer and place it on a level surface. Be sure to remove all packing materials from the inside of the machine.

Clean all parts according to the **CARE AND CLEANING** section in this manual before first use.

## HOW TO MAKE CUSTOM SIZED BAGS WITH THE INTEGRATED BAG ROLL

1. Open Lid and place bag roll into roll storage compartment.
2. Lift up Bag Cutter Bar.
3. Pull enough bag material from roll to hold item to be vacuum packaged, plus 3 inches. Lower the Bag Cutter Bar.

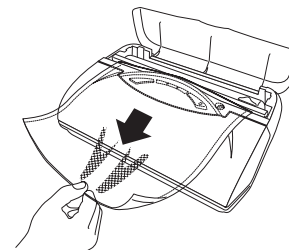

4. Cut desired bag length from Bag Roll. Make sure to cut a straight line. Plug in Power Cord.

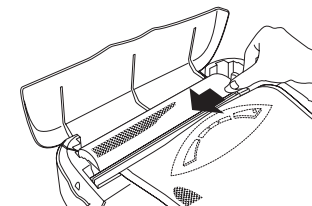

5. Open the Lid. Place one end of the cut bag between the Sealing Strip and the Lower Sealing Gasket. **DO NOT place open end of bag in the Drip Tray**

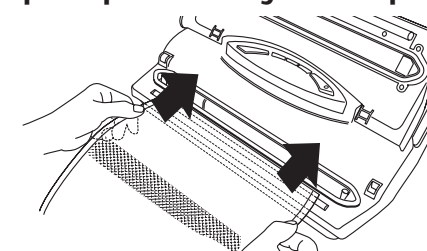

6. Close Lid. Position hands on both sides of the Lid. Press firmly on both sides of the Lid and hold until the motor starts.

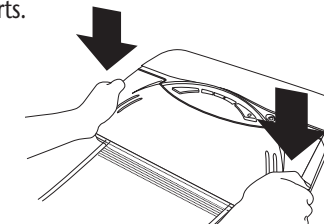

**NOTE:** Sealer will not operate if Lid is not properly closed.

7. Continue to hold the Lid. When the Hands-free Indicator Light illuminates, it is safe to remove your hands from the Lid. The Sealing Indicator Light illuminates when the unit starts sealing the bag.

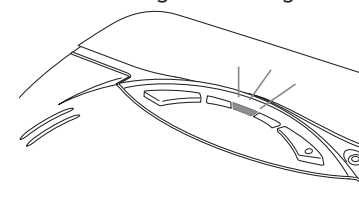

**HOW TO MAKE CUSTOM SIZED BAGS WITH THE INTEGRATED BAG ROLL (CONT.)**

8. When the motor stops and the Progress Indicator Lights shut off, sealing is complete.
9. Press the Open/Cancel button.

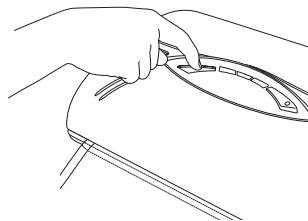

10. The custom sized bag is ready for vacuum sealing.

**NOTE:** The Open/Cancel button can be used to cancel the process mid-cycle and open the Lid. The bag will not be sealed when doing this.

**CAUTION:** This sealer is not for commercial use. If sealing more than 30 bags or canisters in a row wait at least 25 minutes before continuing to use your vacuum food sealer.

**CAUTION:** The unit has a cool down period between cycles. Wait 20 seconds before using again.

**HOW TO VACUUM SEAL WITH SEAL-A-MEAL® BAGS**

1. Place the items to be sealed into a pre-cut or custom sized bag. Leave at least 3 inches between the contents and the top of the bag to allow for bag contraction.
2. Open the Lid and place the open end of the bag down into the Drip Tray.

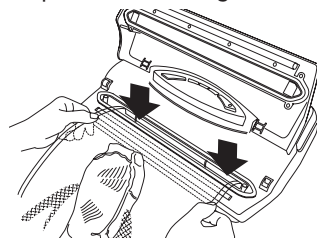

3. Close Lid.
4. Change Press to Select the appropriate Seal Level – Choose Moist for foods with high liquid content or Regular for dry foods.

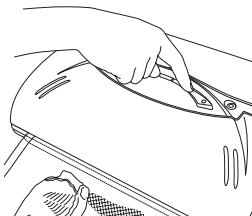

5. To begin the vacuum process, press down firmly on Lid with both hands and hold until the motor starts. Continue to hold the Lid. When the Hands-free Indicator Light illuminates, it is safe to remove hands from the Lid. The unit continues to vacuum and seal the bag.

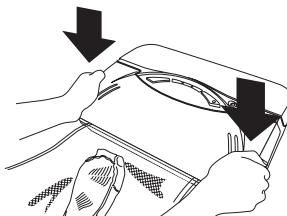
**HOW TO VACUUM SEAL WITH SEAL-A-MEAL® BAGS (CONT.)**

6. When the motor stops and the Progress Indicator Lights shut off, sealing is complete.
7. Press the Open/Cancel button.

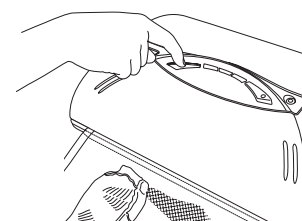

8. Lift the Lid and remove the bag.

**NOTE:** The Open/Cancel button can be used to cancel the process mid-cycle and open the lid. The bag will not be sealed when doing this.

**CAUTION:** This sealer is not for commercial use. If sealing more than 30 bags or canisters in a row wait at least 25 minutes before continuing to use your vacuum food sealer.

**CAUTION:** The unit has a cool down period between cycles. Wait 20 seconds before using again.

**HOW TO VACUUM SEAL WITH SEAL-A-MEAL® ACCESSORIES**

1. Firmly insert one end of the Accessory Hose that came with your Lightweight On-the-Go container into the Accessory Hose Adapter.

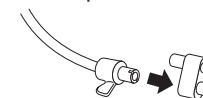

2. Attach the other end of the Adapter into the Accessory Port.

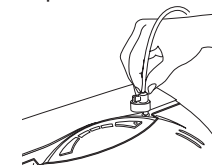

3. Attach the Accessory Adapter over the Vacuum Valve on the Container Lid.

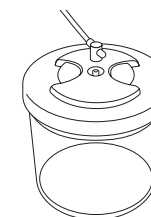

### HOW TO VACUUM SEAL WITH SEAL-A-MEAL® ACCESSORIES (CONT.)

- To begin the vacuum process, press down firmly on Lid with both hands and hold until the motor starts. Continue to hold the Lid. When the Hands-free Indicator Light illuminates, it is safe to remove hands from the Lid. The unit continues to vacuum. Once all of the air is removed, the motor and indicator lights will automatically turn off.

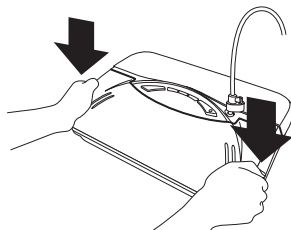

**NOTE:** Sealer will not operate if Lid is not properly closed.

**NOTE:** The Open/Cancel button can also be used to cancel the process mid-cycle and open the Lid.

### HOW TO VACUUM SEAL WITH OTHER BRAND ACCESSORIES

- Firmly insert one end of the Accessory Hose that came with your machine into the Accessory Port.

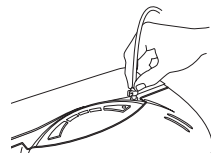

- Attach the other end of the Accessory Hose to the accessory.

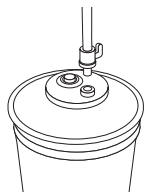

- To begin the vacuum process, press down firmly on Lid with both hands and hold until the motor starts. Continue to hold the Lid. When the Hands-free Indicator Light illuminates, it is safe to remove hands from the Lid. The unit continues to vacuum. Once all of the air is removed, the motor and indicator lights will automatically turn off.

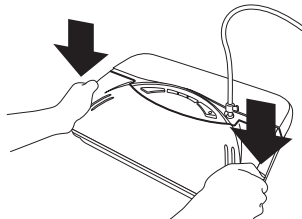

**NOTE:** Sealer will not operate if Lid is not properly closed.

**NOTE:** The Open/Cancel button can also be used to cancel the process mid-cycle and open the Lid.

### CARE AND CLEANING

- Always unplug the unit before cleaning.
- Do not immerse in water.
- Do not use abrasives to clean the unit.
- Wipe the outer surfaces with a soft, damp cloth and soap.
- To clean the inside of the unit, wipe away any food or liquid with a paper towel.
- Dry all parts thoroughly before you plug in and operate the unit again.

#### Cleaning the Removable Drip Tray

The Seal-a-Meal® Vacuum Food Sealer is equipped with a Removable Drip Tray to trap any liquid that may be drawn from the bag. The Drip Tray contains antimicrobial protection, which inhibits the growth of stain and odor causing bacteria and keeps the unit cleaner between uses. Normal cleaning practices should be maintained.

- Lift the lid and carefully remove the Drip Tray as to not spill any contents.
- Wash the Drip Tray in warm, soapy water or on the top rack of the dishwasher.

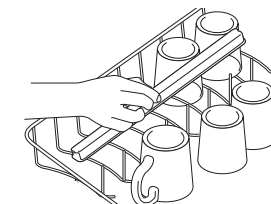
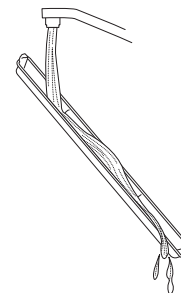

- Allow to dry completely.
- Replace Drip Tray.

#### Cleaning the Bags

- Wash bags in warm, soapy water.
- Bags can be washed in the dishwasher if desired. Turn bags inside out and spread them over the top rack only.
- Allow bags to dry completely before using.

**NOTE:** DO NOT reuse bags if they have been used to store raw meats, fish, oily foods or have been boiled or microwaved.

### HINTS AND TIPS

- **Save Money:** Buy in bulk, separate food into meal size portions, vacuum seal, and freeze. Just remove a the sealed bag, thaw in the refrigerator, and prepare your meal.
- **Save Time:** Prepare meals in advance, vacuum seal, store in the refrigerator or freezer, and reheat for a quick, no-hassle meal.
- **Save Food:** Vacuum seal leftovers to eliminate waste.
- **Save Flavor:** Wash, vacuum, seal, and freeze seasonal fruits and vegetables to enjoy any time of the year.
- **Save clothing, valuable documents, photographs, craft supplies, and much more.**
- **Portion Control:** Separate food into individual portions, write nutritional information on the bag, vacuum seal, and store.
- **Keep Food Fresh Longer.**

Seal-a-Meal® Vacuum Food Storage System Outperforms Conventional Bags & Wraps		
	Storage Time with Conventional Bags & Wraps	Storage Time with Seal-a-Meal® Vacuum Food Storage System
<b>Freezer</b>		
Beef (Steaks, Roasts)	6 – 12 months	2 – 3 years
Beef (Ground, Stew Meat)	3 - 4 months	1 year
Lean Fish (Cod, Haddock)	4 - 6 months	2 years
Fatty Fish (Salmon, Sea Trout)	2- 3 months	1 year
Pork Chops	4 – 6 months	2 – 3 years
Poultry	6 – 12 months	2 – 3 years
Soups and Sauces	2 - 4 months	1 – 2 years
Vegetables	6 – 9 months	2 – 3 years
<b>Refrigerator</b>		
Cheese	2- 4 weeks	4 – 8 months
Deli Meats	3 – 4 days	7 – 10 days
Fruits (Berries)	1 – 5 days	7 - 14 days
Vegetables	2 – 7 days	7 – 14 days
<b>Pantry</b>		
Cereal	2 -3 months	6 – 12 months
Coffee (Ground)	2 weeks	1 – 2 years
Cookies (Homemade)	1 -2 weeks	3 – 6 weeks
Flour	6 - 8 months	1 – 2 years
Nuts	6 - 8 months	1 - 2 years

\*Seal-a-Meal® storage time estimates may vary depending upon preparation, quality of food, and storage conditions.

### TROUBLESHOOTING

PROBLEM	SOLUTION
Nothing happens when I press down on the lid	<ul style="list-style-type: none"> <li>• Make sure the power cord is correctly plugged into the electrical outlet.</li> <li>• Make sure the power cord is not damaged in any way.</li> <li>• Make sure the electrical outlet is operative by plugging in another appliance. If it is not, please check the circuit breakers or fuses in your home.</li> <li>• Make sure the bag is positioned correctly down in the vacuum channel. (See Figures on previous pages)</li> <li>• Press down firmly on both sides of lid.</li> <li>• Wait 20 minutes to allow appliance to cool off, and then try using again.</li> </ul>
Air is not vacuumed from the bag	<ul style="list-style-type: none"> <li>• Check that there are not gaps, folds, wrinkles or holes in the pre-sealed bags.</li> <li>• Verify that the Drip Tray is inserted properly into the unit.</li> <li>• Make sure the Accessory Hose is not inserted into the Accessory Port.</li> <li>• Check for loose, worn or cracked Upper and Lower Sealing Gaskets.</li> <li>• Foods with high liquid contents may prevent the bag from sealing properly. Cut bag open and wipe top inside of bag and reseal.</li> <li>• Check to see if bag is properly inserted into the Drip Tray.</li> <li>• Make sure you've placed the bag in the proper place. When making a bag from a roll, make sure end of cut piece is on Sealing Strip, NOT over Lower Sealing Gasket or in Drip Tray.</li> </ul>
Air has seeped back into the vacuumed bag	<ul style="list-style-type: none"> <li>• Check the seal of the bag. There may be a hole or wrinkle that is allowing air to re-enter the bag. Carefully cut the bag open and re-seal it, or use an entirely new bag.</li> <li>• Make sure there is no moisture or liquid from the food present within the bag. You may need to cut open the bag and re-seal it in moist setting, or use an entirely new bag. Partially freeze foods with excess liquids, prior to vacuum sealing.</li> <li>• Make sure there were no food items with sharp edges that may have punctured the bag. If you find a puncture hole seal the item in an entirely new bag.</li> <li>• Make sure no liquids were drawn to the sealing strip area.</li> <li>• Check for loose, worn or cracked Upper and Lower Sealing Gaskets.</li> <li>• Moisture of foods with high liquid content will prevent the bag from sealing properly. Cut bag open and wipe top inside of bag and reseal.</li> </ul>
Bag melts	<ul style="list-style-type: none"> <li>• The sealing strip may have been too hot during the sealing process. Allow the unit to cool for 20 seconds between uses. If the bag continues to melt, allow the unit to cool with the lid in the upright position for 25 minutes before using.</li> </ul>
Bag will not seal	<ul style="list-style-type: none"> <li>• Check that there aren't any gaps, folds, wrinkles or holes in pre-sealed edges.</li> <li>• Moisture of foods with high liquid content will prevent the bag from sealing properly. Cut bag open and wipe top inside of bag and reseal.</li> <li>• Make sure you've placed the bag in the proper place. When making a bag from a roll, make sure end of cut piece is on Sealing Strip, NOT over Lower Sealing Gasket or in Drip Tray.</li> <li>• Make sure you give the appliance time to cool down. Wait at least 20 seconds between seals.</li> </ul>

**RECIPES**

**OREGANO & GARLIC TOMATO SAUCE**

Use this flavorful sauce immediately or pre-freeze and vacuum seal in a Seal-a-Meal® Vacuum Storage Bag for easy reheating.

- |   |                                       |
|---|---------------------------------------|
| 3 Tbsp. extra-virgin olive oil                  | 1/2 tsp. black pepper, freshly ground |
| 2 medium yellow onions, chopped                 | 3/4 tsp. dried oregano                |
| 2 cloves garlic, minced                         | 3/4 tsp. salt                         |
| 3 28 oz. cans whole peeled tomatoes             | 3 cups swater                         |
| 3 cups tomato sauce (15 oz. can plus 8 oz. can) | 1 tsp. sugar                          |
| 5 Tbsp. canned tomato paste                     |                                       |

In a large, heavy saucepan, heat the olive oil over medium heat. Add the onions and garlic and sauté until softened, about 5 minutes. In a large bowl, crush the tomatoes and add to the saucepan with the remaining ingredients. Stir uncovered for 45 minutes, stirring occasionally, reducing and slightly thickening the sauce.

Makes 16 cups (4 quarts).

**COUNTRY SOUP-IN-A-CANISTER**

Save your leftovers in a Seal-a-Meal® Canister – keep fresh in your refrigerator or freezer.

- |   |                            |
|---|----------------------------|
| 1 lb beef stew meat                     | 1 small onion              |
| 1 carrot                                | 2 celery ribs              |
| 2 garlic cloves                         | 1 28oz can diced tomatoes  |
| basil to taste                          | 3 quarts water             |
| 1 6oz can tomato paste                  | 1/2 cup uncooked wild rice |
| 2 1/2 tsp. black pepper, freshly ground | 1/2 cup dry yellow lentils |
| 3 Tbsp. + 2 tsp. salt                   | 1/2 cup pearl barley       |
| 2 Tbsp. dried onion flakes              | 1/2 cup dry split peas     |
| 2 Tbsp. dried parsley flakes            | 1/2 cup dry red lentils    |
| 2 Tbsp. beef bouillon granules          | 1 bay leaf                 |
| 1 cup uncooked rottini                  |                            |

In a large stockpot, heat 1 tablespoon olive oil over medium heat. Add 1 pound beef stew meat, 1 small diced onion, 1 carrot, peeled and diced, 2 ribs celery, with leaves, washed and diced, and 2 cloves garlic. When the onion is slightly caramelized, add 1 28 oz. can diced tomatoes with basil, 1 6-oz. can tomato paste and 3 quarts water.

Add remaining contents to the stockpot (except for the rottini), stir and bring to a boil. Reduce the heat to low, cover and simmer for 1 hour. Taste and correct any seasonings, add the pasta and stir. Cover and simmer an additional 20 minutes.

Make 18 servings.

**SAVORY HERB MIX**

A flavorful seasoning – and check out [www.seal-a-meal.com](http://www.seal-a-meal.com) for more recipe ideas using Savory Herb Mix!

- |  |                                      |
|--|--------------------------------------|
| 4 Tbsp. salt   | 2 Tbsp. ground paprika               |
| 4 Tbsp. granulated garlic or garlic powder (no salt added) | 2 Tbsp. onion powder                 |
| 4 Tbsp. dried thyme  | 2 Tbsp. black pepper, freshly ground |
| 4 Tbsp. dried parsley                                      |                                      |

Combine all ingredients and mix thoroughly. Place the mix in a Seal-a-Meal® Vacuum Storage Bag and seal airtight. You may store the bag for 1 to 2 years without losing flavor.

**RECIPES**

**SAVORY HERBED CHICKEN WITH TRI-COLORED VEGETABLES**

Seal-a-Meal® Vacuum Storage Bags will keep these vegetables perfectly frozen until you need them, simply prepare ahead!

- |   |  |
|---|--|
| 3 lbs. whole fryer chicken, cut into serving pieces | 1 Tbsp. extra-virgin olive oil               |
| 8 small red potatoes, cleaned and cut in half       | 2 Tbsp. water                                |
| 4 carrots, peeled and cut into thirds               | 2 tsp. Savory Herb Mix (see previous recipe) |
| 1 bunch fresh broccoli, cut into small florets      |  |

Preheat the oven to 375°F. Arrange the chicken pieces, red potatoes, carrots and broccoli in a 9 x 13-inch baking pan. In a small bowl whisk together the Savory Herb Mix, water, and olive oil. Brush the herb oil over the chicken and vegetables and bake, uncovered, for 1 hour, or until the chicken is cooked completely through, with no pink remaining in the thickest part of any individual piece. To serve, place the chicken on a platter, spoon the vegetables around the chicken and drizzle any sauce over the entrée.

Serves 4.

**COWGIRL COOKIES-IN-A-CANISTER**

These cookies have a little bit of everything! Add dried fruit or use butterscotch chips to create your own family favorites. Store your cookies in a Seal-a-Meal® Canister – perfect for the fridge or pantry!

- |                               |                            |
|-------------------------------|----------------------------|
| 1/2 cup butter                | 1/2 cup white sugar        |
| 1 egg                         | 1/2 cup walnuts            |
| 2 Tbsp. milk                  | 1/2 cup rolled oats        |
| 1 tsp vanilla                 | 1/2 cup packed brown sugar |
| 1 cup emsweet chocolate chips | 1/4 tsp. baking powder     |
| 1 1/2 cup all-purpose flour   | 3/4 tsp. baking soda       |

Preheat oven to 350°F. In a large bowl, cream butter until softened. Blend in egg, milk and vanilla, beating until mixed. Add the in the rest of the contents and stir until well blended. Drop by rounded spoonfuls onto a greased cookie sheet. Bake for 10 to 12 minutes. Remove from the oven and transfer the cookies to a wire rack to cool.

**ZESTY LIME MARINADE**

- |                             |                                     |
|-----------------------------|-------------------------------------|
| 1/2 cup of fresh lime juice | 2 cloves of garlic- minced          |
| 2 tbs. grated lime peel     | 1/4 cup of cilantro – chopped fresh |
| 1/2 cup of olive oil        | 2 tsp. of red pepper flakes         |
| Salt & pepper to taste      |                                     |

In a bowl, stir all ingredients until well blended. This is enough marinade for 2 pounds and works well with chicken, beef, fish or shrimp.

For best results, when marinating in a Seal-a-Meal Vacuum Storage Bag, place the food in a Seal-a-Meal Vacuum Storage Bag, fold the bag over and place the unsealed bag inside another Seal-a-Meal Vacuum Storage Bag. Vacuum seal. This helps retain the liquid in the bag.

## Free Manuals Download Website

<http://myh66.com>

<http://usermanuals.us>

<http://www.somanuals.com>

<http://www.4manuals.cc>

<http://www.manual-lib.com>

<http://www.404manual.com>

<http://www.luxmanual.com>

<http://aubethermostatmanual.com>

Golf course search by state

<http://golfingnear.com>

Email search by domain

<http://emailbydomain.com>

Auto manuals search

<http://auto.somanuals.com>

TV manuals search

<http://tv.somanuals.com>