

Welcome to your Sleep Number® Bed

▶ 3000 model
assembly instructions inside

45

80

sleep  number.
by SELECT COMFORT



35

70



Welcome and Congratulations

Welcome and Congratulations,

Congratulations on your purchase of The Sleep Number Bed by Select Comfort™! You're about to join more than 5 million people who've traded their innerspring mattresses for the most innovative sleep surface ever. The technology behind the SLEEP NUMBER® bed is one that recognizes the unique sleeping needs of every individual, which vary according to comfort preference, body type, height, weight, sleeping position, and other health and lifestyle factors. By creating a fully personalized sleep surface, your new Sleep Number® bed offers you customized comfort that can significantly improve your sleep quality.

You'll enjoy years of the latest generation of sleep comfort and technology in your Sleep Number® bed. Our commitment to constant innovation, value and customer satisfaction has repeatedly earned us the *Consumers Digest* Best Buy award. Sleep Number® bed owners like you have made us the No.1 bedding retailer year after year, as ranked by *Furniture/Today*.

We invite you to tell your friends and neighbors about this revolutionary product that can help them attain the most comfortable sleep possible. When your referral results in a purchase, you'll earn valuable rewards* that will make it easier for you to add another Sleep Number® bed to your home and ensure improved sleep for your children or your guests.

We thank you for your purchase and wish you years of personal comfort and restful sleep.

William R. McLaughlin
President & CEO
My Sleep Number® is 55

* See Owners' COMFORT CLUB® Rewards on page 38.

WHAT'S INSIDE

- ▶ Foundation Assembly pg 3
- ▶ Mattress Assembly..... pg 11
- ▶ Firmness Control™ System pg 23
- ▶ Mattress Care..... pg 31
- ▶ Accessories..... pg 33
- ▶ Warranty and Comfort Club® pg 35
- ▶ Comfort Club® Rewards pg 38

Foundation Assembly



Foundation Assembly

If you are missing any items listed on the following page, please e-mail Customer Service at customerservice@selectcomfort.com or call 1.800.472.7185

TROUBLESHOOTING

For answers to some common questions regarding your foundation, see the Frequently Asked Questions at the end of this section.

" I assembled the Sleep Number bed by myself. My wife was in doubt at first, but, after sleeping one night, she said it was magic how well she slept without back pain. Now we sleep longer and more comfortably than on any previous mattress we've owned."

- C. Clark Shedd, Tucson, AZ

BEFORE YOU BEGIN

- ▶ Carefully check the contents of your foundation boxes
- ▶ Decide where to put your new bed
- ▶ Make sure there's an electric power source nearby for use with your Firmness Control™ System
- ▶ Assemble your bed frame if you have one

Your foundation should be assembled directly onto your bed frame or on the floor. Some bed frames have slats that run from one side of the bed to the other. If your bed frame has slats, position the slats evenly to support the foundation. If your bed frame has fewer than three slats, we recommend adding additional slats to ensure adequate support for your foundation.

Caution: With some styles of bed frames, the foundation length may extend beyond the frame's support legs. This situation makes it possible for the frame to tip when significant weight is placed at the foot of the bed. Please use caution when sitting or placing weight on the foot of the bed when using these types of frames.

▶ King foundation

The King foundation consists of two Twins side by side. Complete the assembly of one unit, assemble the second, then place side by side on the bed frame.

CONTENTS

Carefully check the contents of your foundation boxes and compare with the list below. Each component is clearly labeled with the part name and part number.

		QUANTITY			
		Twin	Full	Queen	King
<p>Side Rails</p> 	2 each	2 each	2 each	4 each	
<p>Support /End Beams</p> <p>Texture and surface appearance may vary</p> 	6	6	6	12	
<p>Deck Panels</p> <p>Texture and surface appearance may vary</p> 	2	4	4	4	
<p>Pin Components</p> 	2	2	2	4	
<p>Fabric Coverlet</p> <p>Packaged in the mattress box</p> <p>Shown as packaged</p> 	1	1	1	1	
<p><i>Expanded Queen only</i></p> <p>Corner Brackets</p> <p>Packaged in the mattress box</p> 	0	0	4	0	

1 CONNECT SIDE RAILS

Push the components labeled A side rail and B side rail together.

Joints fit tightly. Push firmly.

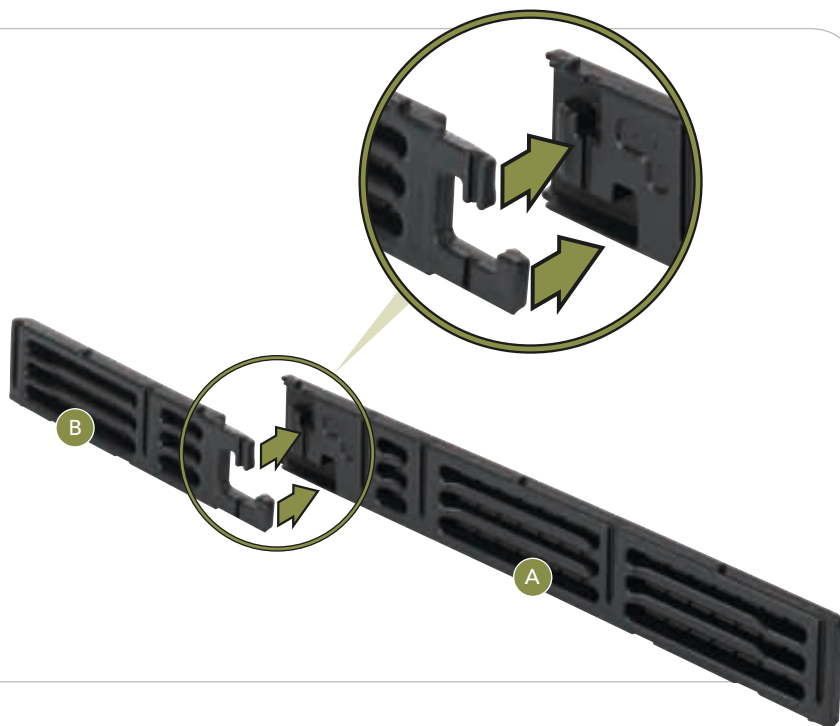

2 INSERT PIN

Slide pins in, "T" end up.

Push firmly.

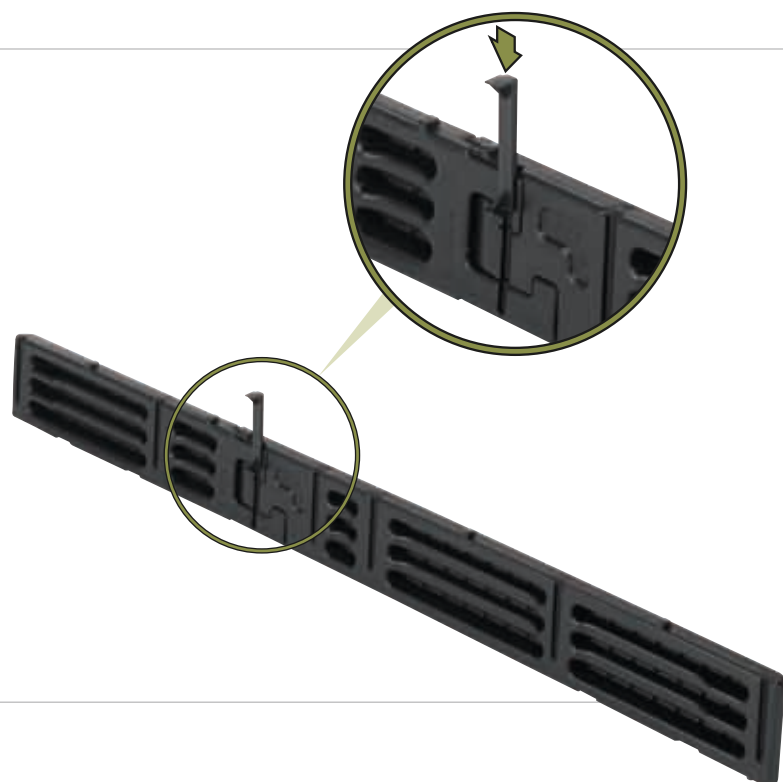

3 INSERT SUPPORT/ END BEAMS

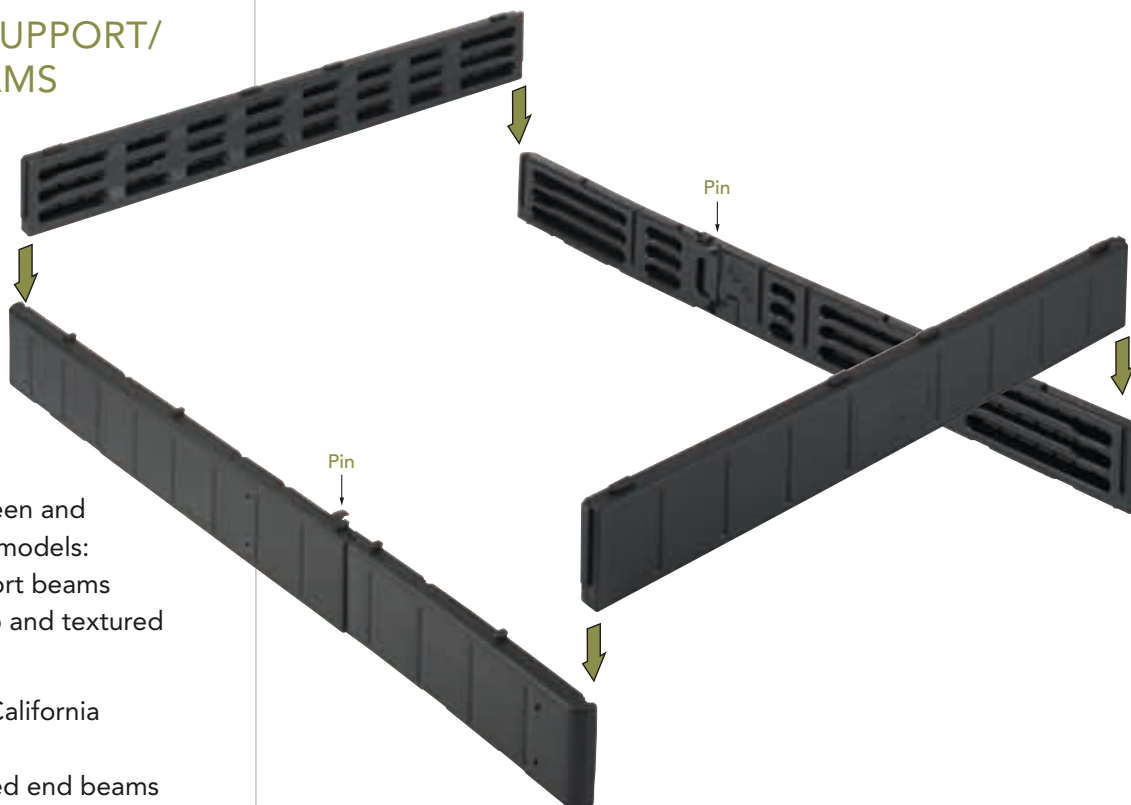

For Twin, Queen and Eastern King models:

- insert support beams with tabs up and textured side out.

For Full and California King models:

- insert labeled end beams followed by remaining support beams with tabs up.

Joints fit tightly. Push firmly until top is flush.

Expanded Queen models only

Attach a corner bracket over each end before connecting to the side rail.

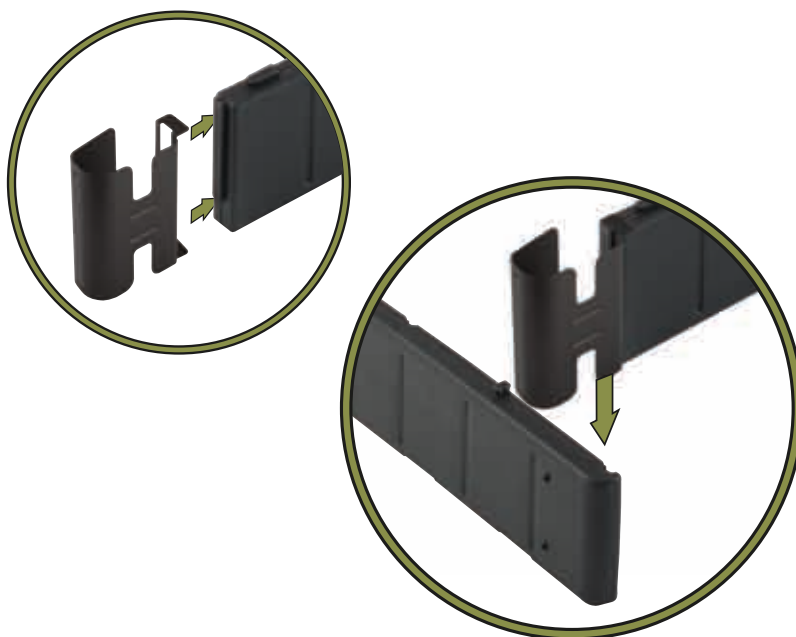

4 INSERT SUPPORT BEAMS

Tab up, match "A" end with "A" groove; match "B" end with "B" groove.

Joints fit tightly, push firmly until top is flush.

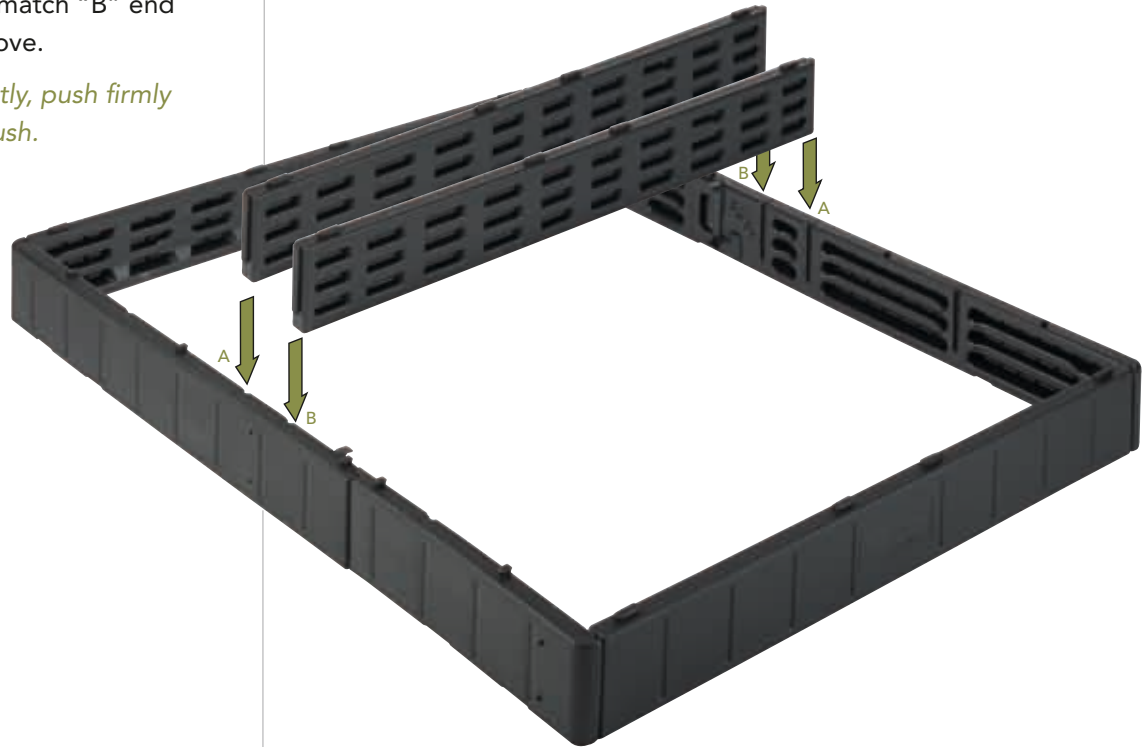

Slide the remaining support beams into the next set of channels.

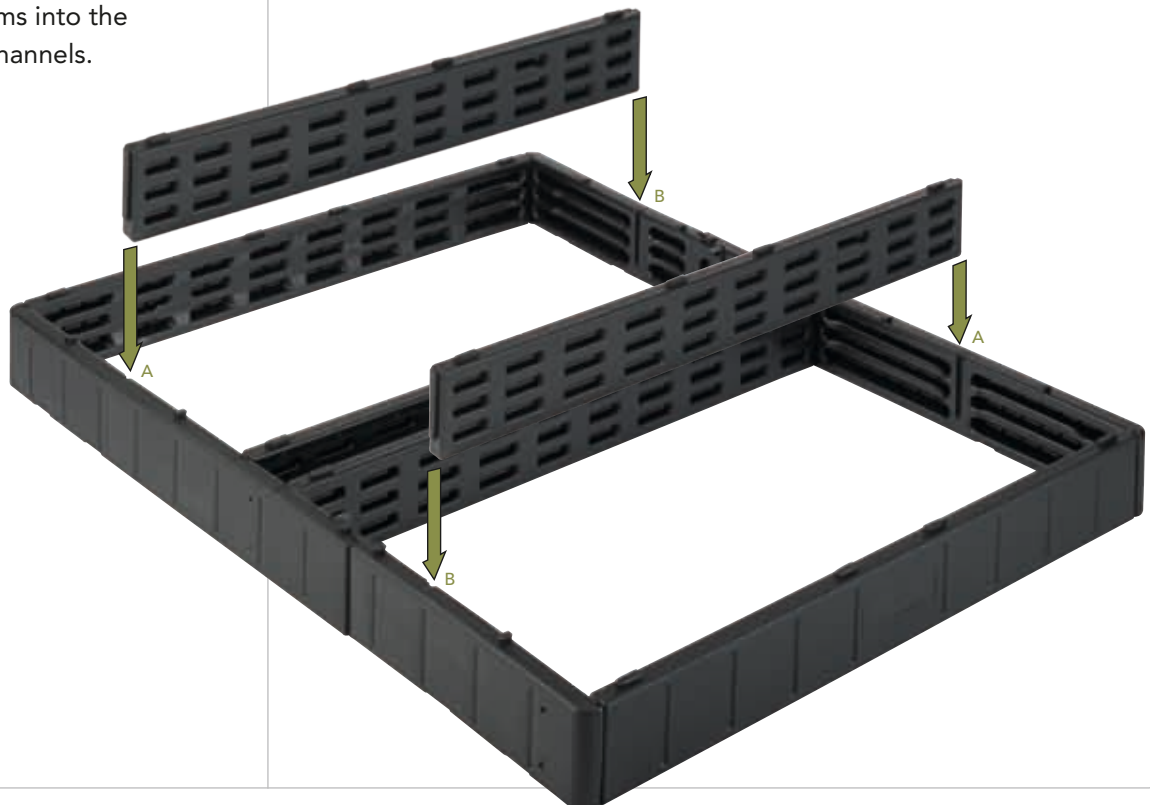

5 PLACE DECK PANELS

Slide panels in until they are flush on sides.

Panels fit snugly, do not force.

Queen shown

Reminder
King foundation consists of two
Twins side by side.

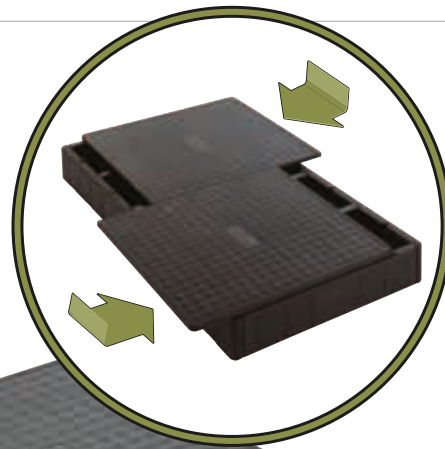

Twin shown



6 PUT ON COVERLET

Work on carefully, one corner at a time, position seam at head of bed.

Expanded Queen coverlet will go over the corner brackets.



YOU'RE DONE! NEXT STEP ► MATTRESS ASSEMBLY

Foundation Frequently Asked Questions

What if I can't get my center support beams flush with the side rails?

Make sure the letter on the center support beam matches the side rail. For example, the end of the center beam labeled "A" should connect to the side rail with the "A" on it. Additional force may be required.

How can I get my pins in all the way?

All pins are wider at one end and narrower at the other end. Make sure the "T" end is up and the narrow end goes into the side rail first. You may need to use a bit of force to get it in place.

What can I do if I can't get the deck panels to lay flat?

First, make sure all the pins and beams are flush. Then, set the deck panel over the notches. You should then be able to slide the panel into place.

Where is the hardware for the footboard and headboard brackets?

The same hardware for attaching the legs to the foundation is used for attaching the brackets. Align the bracket with the holes for the leg bolts. Attach the leg per the instructions.

If you still have questions or need assistance, look for answers on our [Web site](http://www.sleepnumber.com) [sleepnumber.com](http://www.sleepnumber.com) or please call Customer Service at 1.800.472.7185

Mattress Assembly



Mattress Assembly

If you are missing any items listed on the following page, please e-mail Customer Service at customerservice@selectcomfort.com or call 1.800.472.7185

TROUBLESHOOTING

For answers to some common questions regarding your mattress, see the Frequently Asked Questions at the end of this section.

" This is the first time in three years that I slept through the entire night without getting up two or three times. I'm thrilled and amazed! Unbelievable! I wish we had purchased your sleeping system years ago."

- Keith Fisher, Jackson, MI

BEFORE YOU BEGIN

- ▶ Carefully check the contents of your mattress boxes
- ▶ Orientation

These instructions refer to "left" and "right" as if you are standing at the head of the bed looking toward the foot of the bed.

- ▶ Using a Surge Protector

While the Firmness Control™ System may be plugged directly into a wall outlet, we recommend using a surge protector to guard against unexpected power surges. We recommend using a surge protector that is listed to UL® 1449 with a clamping voltage of 330 volts, and a joule rating of 700 or higher.

Please note: Your 20-Year Limited Warranty does not cover damage to the Firmness Control™ System due to a power surge, regardless of the source. See the Limited Warranty on page 37 for more details.

CONTENTS

Carefully check the contents of your mattress boxes and compare with the list below. Each component is clearly labeled with the part name and part number.

		QUANTITY			
		Twin	Full/Queen Single Chamber	Dbl/Queen Dual Chamber	King
<p>Mattress Cover</p> <p>Color and pattern will vary by model</p> <p>Shown as packaged</p> 		1	1	1	1
<p>Foam Border Walls</p> <p>Two long and two short</p> <p>Shown as packaged</p> 		4	4	4	4
<p>Corner Lock System</p> <p>Shown as packaged</p> 		4	4	4	4
<p>Air Chambers</p> 		1	1	2	2
<p>Firmness Control System with Remotes</p> <p>Remotes may vary</p> 		1	1	1	1
<p>Center Foam Wall</p> <p>Dual Chamber models only</p> 		0	0	1	1

1 POSITION MATTRESS COVER

Place on foundation or on existing bed platform.

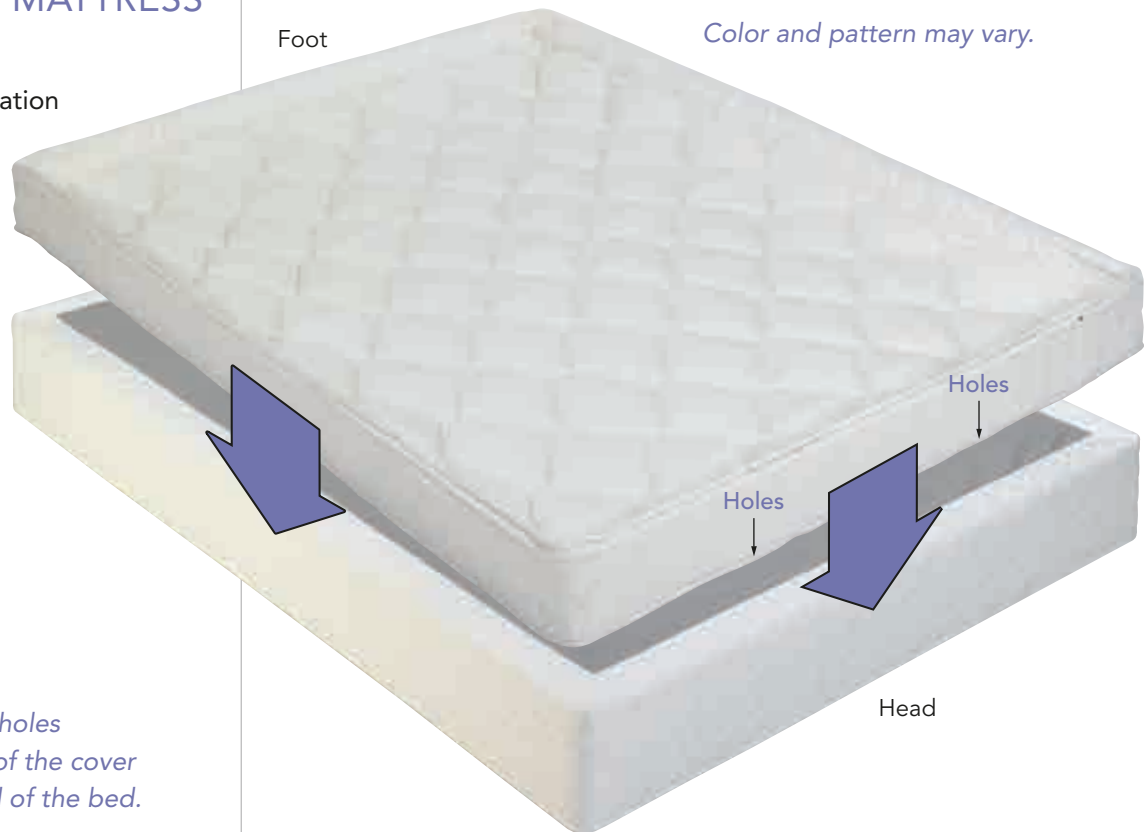

Make sure the holes in the bottom of the cover are at the head of the bed.

2 UNZIP MATTRESS COVER

Set cover aside.



3 PLACE CORNER LOCKS

Place one in each corner.

Corner locks must go under the border wrap.



4 INSTALL FOAM BORDER WALLS

Place long border walls along sides.

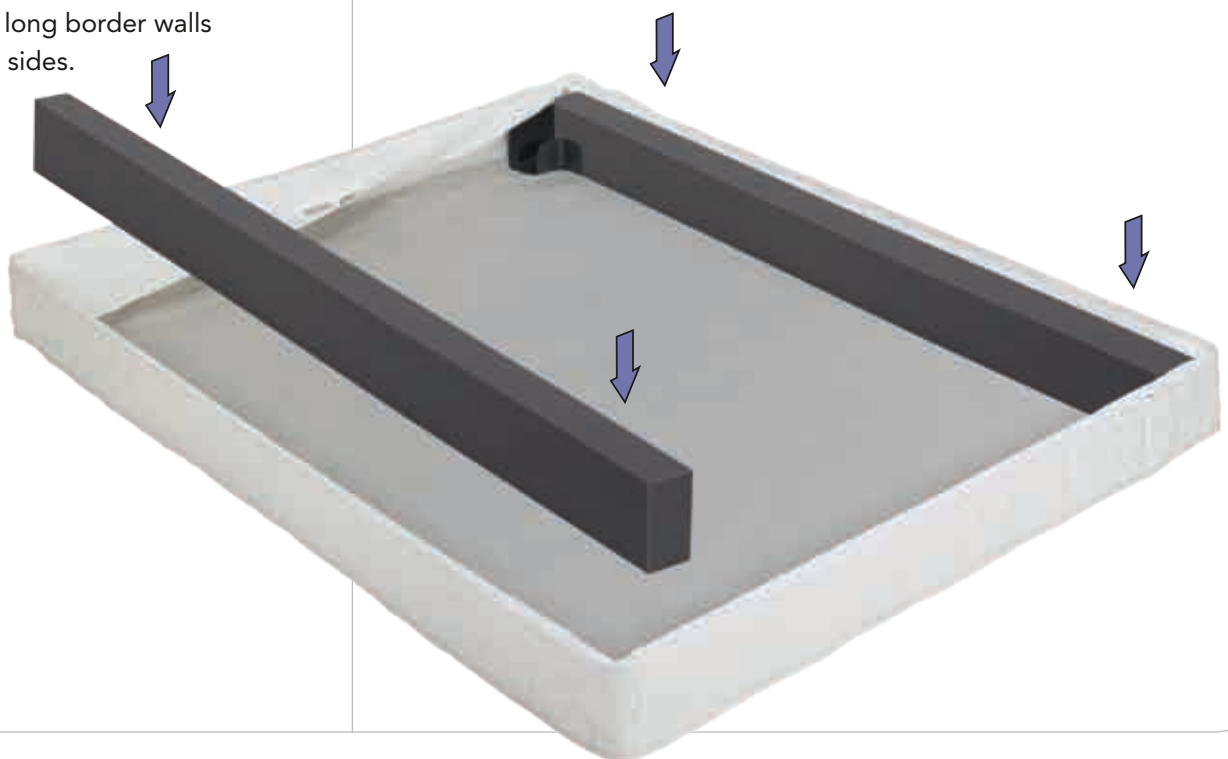

5 INSTALL FOAM BORDER WALLS

Place short border walls at the head and foot.

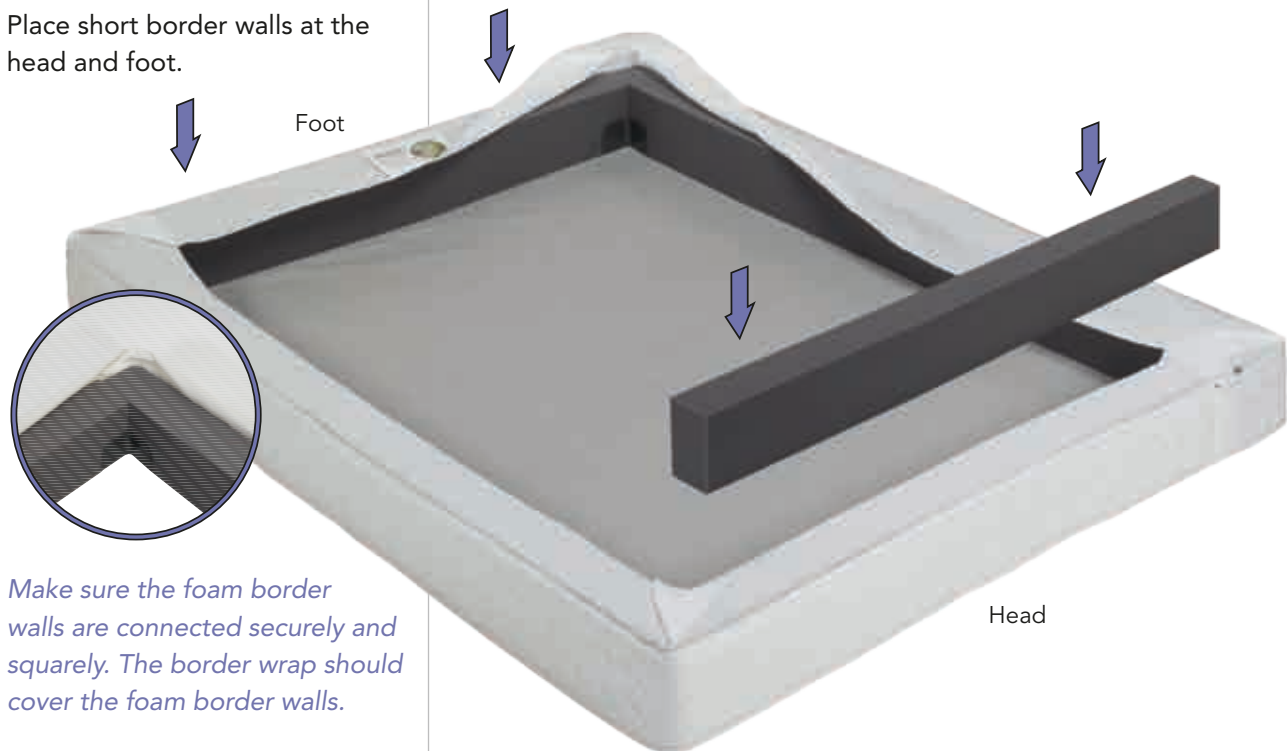

Make sure the foam border walls are connected securely and squarely. The border wrap should cover the foam border walls.

6 INSTALL AIR CHAMBERS

Place air chambers so the hose connectors face the head of the bed, and lay on bottom when inflated.

Dual chambers shown

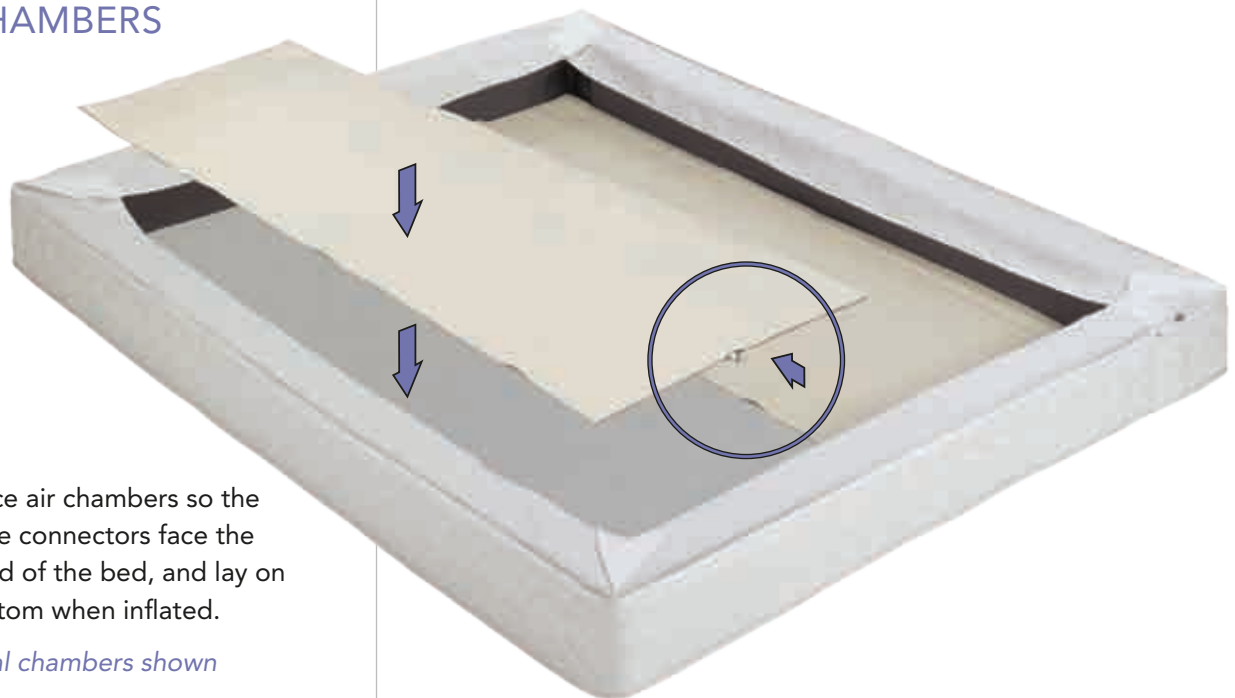

7 CONNECT FIRMNESS CONTROL™ SYSTEM

Place the Firmness Control™ System on the floor at the head of the bed and plug in the power cord.

Key Step:

Pass the hose marked "L" through the hole on the left side of the mattress cover and connect to the left air chamber.

Press hose connections together until they click.

Then complete the right side.

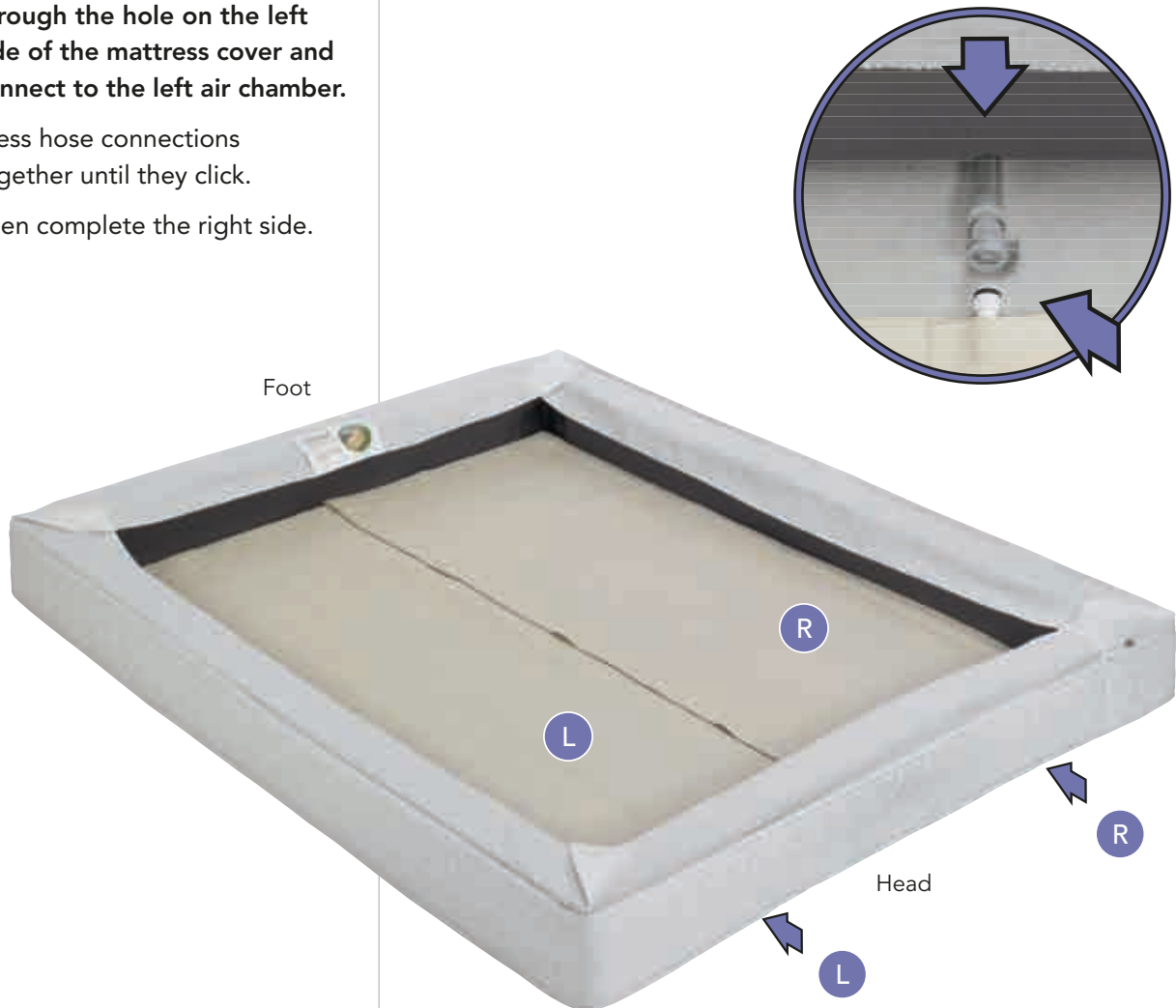

8 INFLATE AIR CHAMBER(S)

Using remote, inflate air chamber.

For dual chamber models, repeat for second air chamber.



If using a digital SLEEP NUMBER® remote, press L or R to activate and select a side.

Press and hold the firmer button to inflate the mattress.

Insert center foam wall between the two chambers.

9 VERIFY BORDER WRAP POSITIONING

Position the border wrap over foam border walls and air chambers as shown.

Important Notice: To ensure compliance with federal and state flammability requirements, the border wrap must be positioned correctly within the mattress as shown in the steps below.

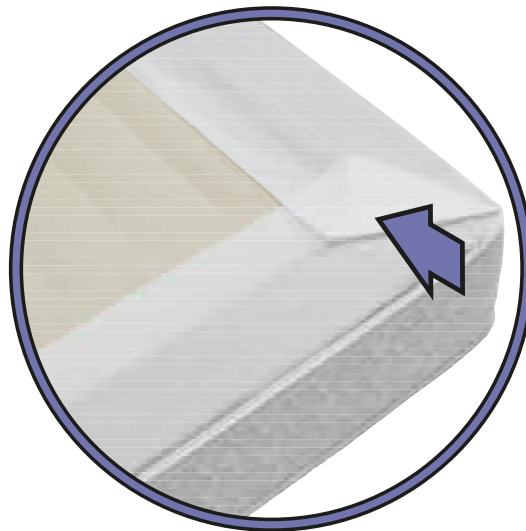

10 MATTRESS COVER

Zip the top of the mattress cover.



Store air chamber caps inside mattress at head of bed.

Color and pattern may vary.

**YOU'RE DONE! NEXT STEP ►
THE FIRMNESS CONTROL™ SYSTEM**

Mattress Frequently Asked Questions

Where are the caps for air chamber(s)? And where should I store them?

The caps are in the Firmness Control™ System box. Please store these in the mattress cover in case you should ever want to disassemble your bed and temporarily cap your air chamber(s).

What do I do if the Firmness Control™ System doesn't run?

Make sure the power cord is securely plugged into the Firmness Control™ System and the wall outlet. Check to see if the power cord is plugged into an outlet that has power and is not connected to an on/off wall switch.

What if I feel like I'm rolling toward the edge or toward the center of the mattress?

Although rare, these sensations could potentially be experienced if one side of the mattress is set quite firm and the other side quite soft. Call Customer Service for a remedy to this situation if it is bothersome to you.

What if I notice a rubber smell from the air chamber?

The odor you may smell is non-toxic and will fade over time. To minimize the smell, allow the air chamber to air out for a few hours and then lay a couple of dryer sheets on top of the air chamber.

Will my bed deflate if there is a power surge or power loss?

No, your mattress will maintain its firmness. To protect your Firmness Control™ System, we do recommend using a surge protector.

The mattress is losing air. What should I do?

The air loss could be caused by either the air chamber or the Firmness Control™ System. To determine which component is causing the air loss, follow these troubleshooting steps:

- Inflate the side of the bed that is losing air to the preferred firmness. If using a digital SLEEP NUMBER® remote, set it to your setting plus five (i.e., if you sleep at a setting of 40, inflate the bed to 45).
- Locate the caps, and cap the side of the bed that is losing air. The assembly instructions suggested storing the air chamber caps in the mattress cover, at the head of the bed, where the zipper starts/ends.
- Leave the air chamber capped for at least eight hours. It is preferable to cap it overnight while sleeping on it.
- Contact Customer Service with the results of the troubleshooting. They will facilitate a component replacement under the terms of the warranty.

Mattress Frequently Asked Questions

Why are there body impressions on the mattress cover?

For the best looking, most crisp appearance, customers should fully inflate the mattress (100 if using a digital Sleep Number® remote). If going to full inflation does not help with body impressions in the cover, the quilted top can be removed and shaken to restore some of the loft to the fiberfill. In addition, a vacuum nozzle may be used to fluff the cover in areas where the fibers have settled from use.

Body impressions in a normal innerspring mattress would be an indication that the spring support is compressing or breaking down. The Sleep Number® bed uses air to support your body. Since air cannot break down, you receive the same support after years of use as you do on the first day of use.

Please contact Customer Service with further questions.

If you still have questions or need assistance, look for answers on our Web site sleepnumber.com or please call Customer Service at 1.800.472.7185

Firmness Control™ System



sleep  number.
by SELECT COMFORT

Firmness Control™ System

If you are missing any items listed on the following page, please e-mail Customer Service at customerservice@selectcomfort.com or call 1.800.472.7185

TROUBLESHOOTING

For answers to some common questions regarding your Firmness Control™ System, see the Frequently Asked Questions at the end of this section.

" I had forgotten what it feels like to wake up feeling good and with energy. Sleeping on the Sleep Number bed has made a big difference. Thank you for making me feel good again."

- Vicky Hendricks, Hartford, KY

THINGS TO REMEMBER

► Reasons to alter the firmness of your bed

- strained muscles
- back pain
- weight change
- pregnancy
- sunburn
- new sleep position

as well as

- to facilitate getting out of bed, if needed
- to achieve a fuller bed appearance

► Dual Adjustability

If you purchased a dual chamber model, you have the ability to personalize each side of your SLEEP NUMBER® bed. Since no two body types are the same, each sleep partner should find their own comfort level.

If your model came with one remote for a dual chamber bed, the "L" button on the remote corresponds to the left side of the bed (left is determined when lying on your back on the bed).

WHAT IS A SLEEP NUMBER® SETTING?

Your Sleep Number® is a setting between 0–100 that represents the ideal combination of mattress comfort, firmness and support for your body, giving you the best night's sleep possible.

YOUR SLEEP NUMBER® SETTING

When you shopped for The Sleep Number Bed by Select Comfort™, you may have discovered your Sleep Number® setting. You should use this as a starting point when setting the firmness of your Sleep Number® mattress. If you don't have your Sleep Number® setting, this section will take you through the process of finding your Sleep Number® setting and will provide you with additional information about your Sleep Number® bed. If you don't already have your Sleep Number® setting or if you would like to experiment with finding a different Sleep Number® setting, use the instructions below.

EVALUATING YOUR COMFORT LEVEL

As you are customizing the Sleep Number® bed for your optimum comfort level, you will want to evaluate your sleep position and determine how you feel as compared to the diagrams below, then make adjustments to your firmness or pillow if needed. Your pillow should help keep your body aligned properly, otherwise it may interfere with your ability to sleep comfortably. Visit sleepnumber.com or one of our stores to get a PillowFitSM profile and see the extensive selection of innovative pillows we carry for all sleep positions and fill preferences.

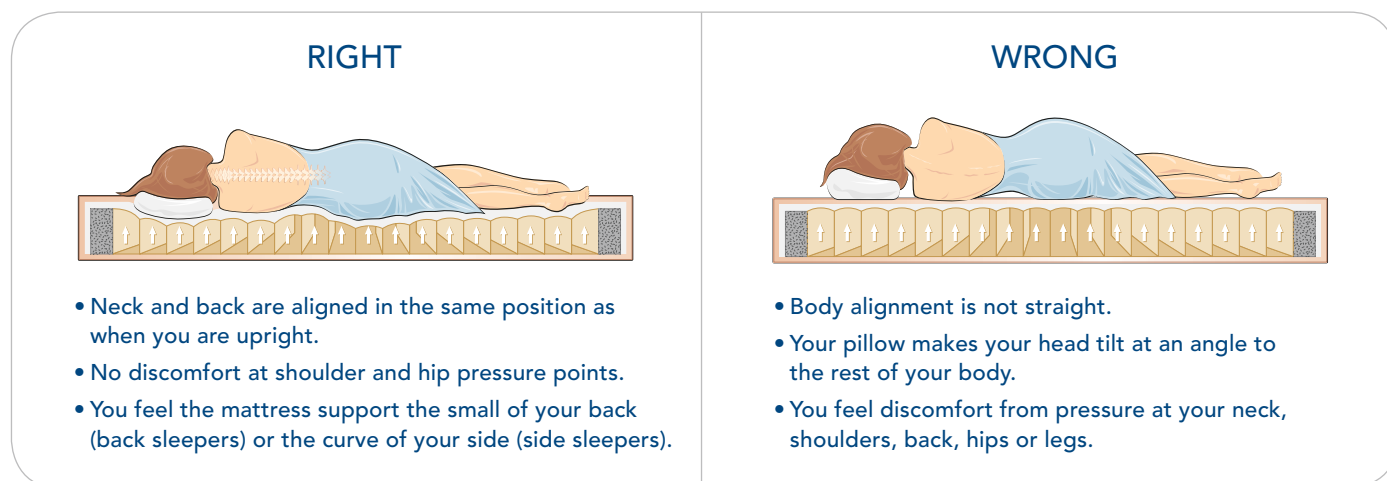

GIVE IT TIME

It sometimes takes several nights of sleeping at different settings to discover your ideal Sleep Number®. If you would like to experiment further with your Sleep Number® setting, you may want to consider keeping a sleep journal. When you have found a Sleep Number® setting where you feel comfortable, log this number into your sleep journal. Try to sleep at this Sleep Number® setting for a minimum of five nights, adjusting in increments of 5 or 10 only. It will take your body that long to become accustomed to a new sleep surface. After five nights, reevaluate your comfort level and log the new setting into your sleep journal, adding comments if helpful. Repeat the process until you have found the perfect setting for you.

If, after trying four different Sleep Number® settings, you have not found your ideal Sleep Number® setting and would like additional assistance, go to sleepnumber.com and click on Customer Center or call 1.800.472.7185 to reach a Customer Service Representative. Our trained Customer Service Representatives may be able to recommend adjustments, make suggestions or pinpoint concerns that might be contributing to less than ideal comfort. Improving your sleep is our expertise.

IDENTIFY YOUR REMOTE AND ITS FUNCTIONS

3000 wired



Firmer
Softer

wakes when any button is pressed

3000 wired Single Chamber



Firmer
Softer

wakes when any button is pressed

3000 wired Dual Chamber

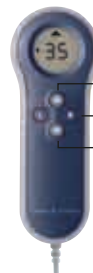

Firmer
Side
Softer

wakes when L or R button is pressed

BUTTON

FUNCTION

3000 Firmer ▲
Softer ▼

Press and **hold** down buttons to make the bed softer ▼ or firmer ▲ until comfortable, then release.

Side (L) and (R)

Press to choose a side, it will display the previous SLEEP NUMBER® setting.

Class B Device Statement: (Section 15.105 (b) of the FCC Rules) "Note: This equipment has been tested and found to comply with the limits for a Class B digital device, pursuant to part 15 of the FCC Rules. These limits are designed to provide reasonable protection against harmful interference in a residential installation. This equipment generates, uses, and can radiate radio frequency energy and, if not installed and used in accordance with the instructions may cause harmful interference to radio communications. However, there is no guarantee that interference will not occur in a particular installation. If this equipment does cause harmful interference to radio or television reception, which can be determined by turning the equipment off and on, the user is encouraged to try to correct the interference by one or more of the following measures:

- Reorient or relocate the receiving antenna.
- Increase the separation between the equipment and receiver.
- Connect the equipment into an outlet on a circuit different from that to which the receiver is connected.
- Consult the dealer or an experienced radio/TV technician for help.

This device complies with Part 15 of the FCC Rules. Operation is subject to the following two conditions: (1) this device may not cause harmful interference, and (2) this device must accept any interference received, including interference that may cause undesired operation.

FINDING YOUR SLEEP NUMBER® SETTING

► Step 1

- Lie on one side of the Sleep Number® bed in your normal sleep position, holding your remote.

► Step 2

- Evaluate your comfort level.

► Step 3

- If you have a dual chamber model press L or R to choose a side.

► Step 4

- Press and hold the firmer or softer buttons and let the bed adjust. Repeat until you have reached your desired level of comfort. If you've upgraded to a digital remote, your new Sleep Number® setting will be displayed.

► Step 5

- Your setting will be displayed for five seconds.

► Step 6

- Try this Sleep Number® setting for a minimum of five nights, then reevaluate and make adjustments accordingly.

SLEEP NUMBER® STUDY

As you can see, Sleep Number® bed owners find comfort at all settings from 0–100, however the majority of sleepers find their Sleep Number® setting between 35–50.

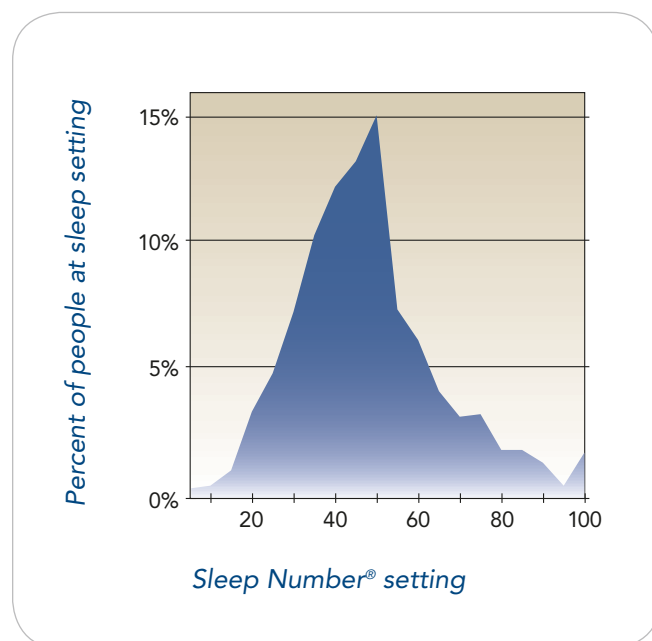

Firmness Control™ System Frequently Asked Questions

Will my bed deflate if there is a power surge or power loss?

No, your mattress will maintain its firmness. To protect your Firmness Control™ System, we recommend using a surge protector.

What do I do if the Firmness Control™ System doesn't run?

Make sure the power cord is securely plugged into the wall outlet. Check to see if the power cord is plugged into an outlet that has power and is not connected to an on/off wall switch. If the Firmness Control™ System still will not function, call Customer Service.

Why does my Sleep Number® setting change?

There are several factors that can contribute to the fluctuations in a SLEEP NUMBER® setting. A Sleep Number® setting is based on the combination of body weight, volume of air in the air chamber and sleep position.

- Temperature: An increase or decrease in temperature can cause changes in the Sleep Number® setting. A heated mattress pad will cause the Sleep Number® setting to increase.
- Barometric Pressure: Changes in atmospheric pressure related to weather and altitude can cause your Sleep Number® setting to change.
- Weight: The Firmness Control™ System acts similarly to a scale; more weight means a higher Sleep Number® setting. In addition, the way that the weight is distributed will affect the reading.
- Sleep Position: The more concentrated the weight is, the greater chance the Sleep Number® setting will be higher (i.e., when you lie on your side). When it is distributed throughout the chamber more, it is more likely that the Sleep Number® setting will be lower (i.e., when you lie on your back or stomach).

Sleep Journal

Sleep Number® setting	Number of nights	Comments

Mattress Care

25

60

MATTRESS CARE

The cover of your SLEEP NUMBER® mattress may be spot cleaned with carbonated water. Do not dry clean the mattress cover or put it in a washing machine. Also, please do not apply stain guard, as it may cause yellowing of the fabric.

Select Comfort is a leader in the industry in the use of materials designed to inhibit the growth of allergens or microorganisms that, in rare circumstances, can form inside any mattress, bedding, pillow or upholstered product.

Advanced antimicrobial safeguards are incorporated into every Sleep Number® bed. Key components of the mattress have been treated to protect the bed from contaminants such as mold, mildew and bacteria growth. The unique, zip-open design of the Sleep Number® bed allows you to easily open, ventilate or vacuum if you choose.

In rare instances under the right conditions, mold or mildew can form inside many types of mattresses, bedding or upholstered products. Should this condition occur in your mattress, please contact our customer service department so we can work with you to return your bed to factory-fresh condition.

TRANSPORTING YOUR SLEEP NUMBER® BED

Your Sleep Number® bed is lighter than any conventional bed, making it much easier to move.

Moving it yourself

- The foundation should always be disassembled. Bag all hardware so that it is not lost.
- The cover and foam should all be double bagged to prevent stains.
- The chambers should be deflated and boxed to prevent possible abrasions and other damage.
- The Firmness Control™ System should be packed in a box, surrounded by some sort of packing material if the original box is not available.
- The remote, caps and instructions should be tucked in the box with the pump to prevent them from being lost.

Using a moving company

- The foundation should always be disassembled. Bag all hardware so that it is not lost.
- The mattress can be fully inflated, capped off, and should be packaged in a mattress box for moving.
- The Firmness Control™ System should be packed in a box, with packing material, and transported in a manner where it will be exposed to minimal shock and vibration.

Creating a Healthy Sleep Environment

An estimated 50 million Americans suffer from allergies, and the bedroom presents some especially difficult challenges. A few simple steps you can take to create a healthy sleep environment include:

- Use a dehumidifier to reduce any potential mold or mildew growth. Keep humidity levels under 60 percent.
- Use a high-quality mattress pad to protect your mattress from moisture. You may want to consider a waterproof mattress pad if you perspire heavily while sleeping.
- Use allergen covers on pillows and mattresses to reduce dust mites, which can trigger allergies and asthma. Wash bedding weekly in hot water.
- Vacuum the bedroom regularly, using a high quality vacuum cleaner such as one with a HEPA filter, one that does deep cleaning, or a central vacuum system.
- Wait 20-30 minutes before making your bed each morning, turning the covers back and allowing the mattress to air out for a bit.
- If possible, avoid placing your bed on an outside wall or above an air conditioning or heating vent, which can cause condensation and increase the likelihood of mold growth in many mattresses.
- You could also use a high-quality electronic air purifier to remove additional airborne particulates from the bedroom.
- Please note: Ozone generators ARE NOT recommended for use in the same room with the Sleep Number® bed, as they can degrade components of the bed over time.

Accessories



PERSONALIZED COMFORT FROM HEAD TO TOESM WITH EXCLUSIVE SELECT COMFORT[®] ACCESSORIES

Pillows

Our sleep-position pillows are available in memory foam, Intralux[®] comfort material, 100% down, down blend or down-alternative fills. You'll be amazed at the difference a perfectly fitted pillow can make. We can fit you with a comfortable, supportive pillow that fits your sleep position, unique shape, and mattress firmness or SLEEP NUMBER[®] setting.

Blankets and Comforters

Experience all-season comfort with products designed to meet the different warmth needs of every sleeper. Dual warmth items allow couples to further customize their sleep.

Sheet Sets

Custom designed to fit your Sleep Number[®] bed, our sheet sets are available in pima cotton sateen, luxurious Supima[®] cotton and our finest Egyptian cotton. Available in a variety of colors.

Mattress Pads

Protect your investment with our high-quality mattress pads, and add a layer of comfort and breathability to your Sleep Number[®] bed.

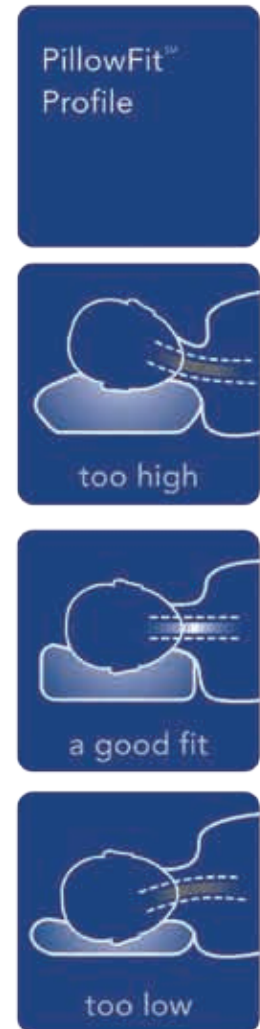

LOGIC[™] LABEL

The Logic[™] Label takes guesswork out of where to start making your bed. Instead of trying to fit mattress pads or sheets around the wrong bed corners and coming up short, you'll be guided with a simple visual cue that perfectly positions all your Sleep Number[®] bedding. Each bedding accessory carries a small label to match the one featured at the end of your Sleep Number[®] bed—your bed linens will be positioned correctly when all the labels align.

Warranty and Comfort Club®

80

" We love our bed. Now all of our friends are getting Sleep Number beds and they love them too. I just received an email from a friend who purchased a King Sleep Number bed and finally found relief from his back pain. What more can we say than 'Thank You' for this fabulous product. We'll never stop recommending your beds."

- Jolie C., Homewood, IL

DEFECTIVE OR DAMAGED COMPONENTS

If any component of the mattress or foundation is found to be defective in materials or workmanship within first two years of the original purchase date, they will be replaced by Select Comfort at no cost to you. Within the first two years, all shipping charges to replace a defective component will be covered by Select Comfort. If any component of the mattress or foundation is found to be defective in materials or workmanship after two years from the original purchase date, the terms of the Limited Warranty will apply. After two years from the date of purchase, you will be responsible for the cost of shipping the defective component back to Select Comfort and any related costs. Contact our Customer Service Department at 1.800.472.7185 for troubleshooting assistance and if you need to process the replacement order. We recognize the fact that components may break, become soiled or unusable and may not be covered under the warranty. As long as you own our bed and can provide proof of purchase, you can purchase replacement components. All component sales are final and carry a 2-Year Limited Warranty from the purchase date. Product discounts and accessory promotions do not apply to components. Call our Customer Service department for current pricing and to process the component purchase.

RETURN POLICY

We hope you are completely satisfied with your SLEEP NUMBER® bed, but if you decide to return the bed during the In-Home Trial, contact Customer Service before packing your bed. All merchandise being returned must be in good condition and be given a Return Merchandise Authorization number from Customer Service, which will expire 30 days from date of issue. All refunds will be issued to the original method of payment within approximately 15 business days after all products have been received at Select Comfort. All shipping and incidental charges to return the bed are the customer's responsibility.

LIMITED WARRANTY

What is covered:

- Select Comfort warrants that your mattress and/or foundation will be free from defects in materials and workmanship for a period of 20 years from the original purchase date.
- Warranty is limited to product repair or replacement only.

What is not covered:

- Conditions arising from normal wear and tear. (Conditions arising from normal wear and tear include, but are not limited to: mattress cover compression, foam compression, or discoloration of components.)
- Damage from tampering with any component or from opening the Firmness Control™ System.
- Damage from misuse or abuse of the warranted product or component.
- Damage from laundering or dry-cleaning.
- Acts of God, such as but not limited to lightning damage.

What you must do:

- Return the warranted product or component in sanitary condition to an authorized SELECT COMFORT® service center. Select Comfort will incur the cost of shipping up to two years after the original purchase date; after two years, the return shipping to Select Comfort will be at the customer's expense.
- Please telephone our Customer Service Department at 1.800.472.7185 to locate the nearest authorized service center and arrange for the return of the warranted product or component.

What we will do:

- Select Comfort, at its option, will repair or replace the defective product or component at a cost to the original purchaser based on the following table. The "price" is the price of the defective product or component at the time the warranty claim is made, or the price of a comparable product or component if the original product or component is no longer in production.

Years after purchase date	Original purchaser's cost
Up to 2 years	No Cost
2-20 years	20% plus 4% of price for each year from original purchase date.

- For example, if a warranty claim arises 12 years after the original purchase date, the cost to the original purchaser would be 68% of the price (that is, 20% plus 4% for each of the 12 years) and Select Comfort would be responsible for the remaining 32% of the price.

- Select Comfort reserves the right to substitute products or components of equal or better quality, and to use or deliver refurbished products or components in the repair or replacement of any product under this Limited Warranty.

What will void this warranty:

- Tampering with any component or opening the Firmness Control™ System and its hand control unit.
- Misuse or abuse of the warranted product or component.
- Sale, transfer or other disposal of the warranted product or component.

Limitations:

- Your exclusive remedy, IN LIEU OF ALL INCIDENTAL, SPECIAL OR CONSEQUENTIAL DAMAGES, INCLUDING FOR NEGLIGENCE, is limited to repair or replacement of any product or component deemed to be defective under the terms and conditions stated above. Select Comfort will bear no other damages or expenses.
- Customer maintains responsibility for installation of parts replaced under terms of the warranty.
- Select Comfort reserves the right to refuse to repair or replace any product or component that is returned in an unsanitary condition.
- This Limited Warranty applies only to the product as used in the United States and Canada. It is not applicable in U.S. territories or other countries.
- This Limited Warranty is non-transferable.
- Repair or replacement of a product or component under the terms of this Limited Warranty in no way lengthens the Limited Warranty period.
- ANY IMPLIED WARRANTIES APPLICABLE TO THIS PRODUCT, INCLUDING ANY WARRANTIES OF MERCHANTABILITY OR FITNESS FOR A PARTICULAR PURPOSE, ARE LIMITED IN DURATION TO THE DURATION OF THIS WRITTEN LIMITED WARRANTY.

Some states do not allow the exclusion or limitation of incidental or consequential damages, or limitations on how long an implied warranty lasts, so the above limitations may not apply to you. This warranty gives you specific legal rights and you may also have other rights, which vary from state to state.

All claims relating to the Limited Warranty of Select Comfort® products should be made by contacting Customer Service at 1.800.472.7185 or writing to Select Comfort Customer Service, 6105 Trenton Lane North, Minneapolis, MN 55442.

COMFORT CLUB® REWARDS

It's amazing how many SLEEP NUMBER® bed purchasers are referred to us by family and friends! Chances are you will soon be telling someone about the difference the Sleep Number® bed has made in your life. We appreciate it when owners like you help us spread the word to others about our revolutionary bed. It is our company's mission to improve lives by Revolutionizing the Way America SleepsSM— one bed at a time.

Tell Your Family and Friends and Earn Rewards!

As an owner, you are eligible to participate in our Owners-Only rewards program. Every time someone you refer purchases The Sleep Number Bed by Select Comfort™, you can earn Comfort Club® Reward Certificates! These certificates can be redeemed any time you shop with us—on accessories such as pillows or mattress pads, or even toward the purchase of another bed! Call 1.800.422.4204 for details.

Tell Us Why You Like Your Bed

We'd love to hear why you like your new Sleep Number® bed. If you have any comments about the product and service you received, or suggestions as to how we might serve you better, please fill out the form on this page and send it in.



Please tell us why you like your new Sleep Number Bed by Select Comfort™.

Comments:

Name Email

Address Bed model purchased

City/State/Zip Your Sleep Number® setting

Phone May we reprint your comments? Y N

▲ Tear page from manual, fold and mail.

Another satisfied
Sleep Number® bed owner

sleep  number
by SELECT COMFORT



NO POSTAGE
NECESSARY
IF MAILED
IN THE
UNITED STATES

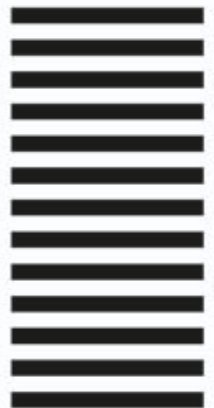

BUSINESS REPLY MAIL
FIRST-CLASS MAIL PERMIT NO.6 MINNEAPOLIS, MN

POSTAGE WILL BE PAID BY ADDRESSEE

select  comfort

CREATOR OF THE SLEEP NUMBER® BED

SELECT COMFORT CORPORATION
6105 TRENTON LANE NORTH
MINNEAPOLIS MN 55442

Help is just a click or phone call away.

If you ever have product questions or need additional assistance obtaining optimal comfort, please visit us at:

sleepnumber.com

or call

1.800.472.7185

Representatives are available (CST):

Monday–Friday 7am – 10pm

Saturday 8am – 5:30pm

Sunday 10am – 6:30pm



110484

sleep  number.
by SELECT COMFORT

6105 Trenton Lane North, Minneapolis, Minnesota 55442

Free Manuals Download Website

<http://myh66.com>

<http://usermanuals.us>

<http://www.somanuals.com>

<http://www.4manuals.cc>

<http://www.manual-lib.com>

<http://www.404manual.com>

<http://www.luxmanual.com>

<http://aubethermostatmanual.com>

Golf course search by state

<http://golfingnear.com>

Email search by domain

<http://emailbydomain.com>

Auto manuals search

<http://auto.somanuals.com>

TV manuals search

<http://tv.somanuals.com>