

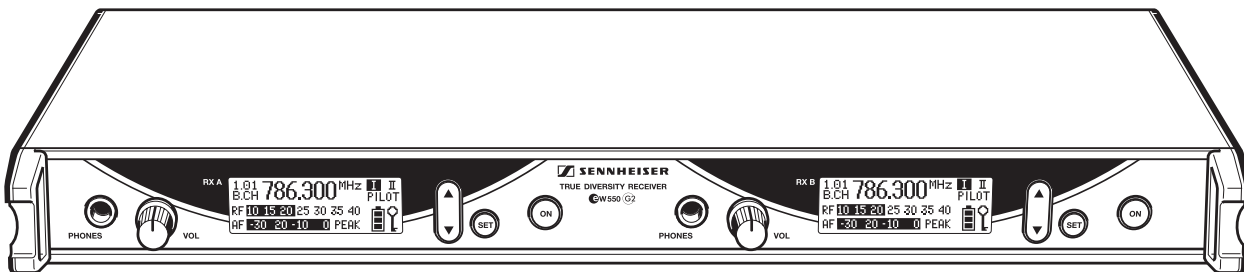

EM 550 **G2**

Instructions for use



Thank you for choosing Sennheiser!

We have designed this product to give you reliable operation over many years. Over half a century of accumulated expertise in the design and manufacture of high-quality electro-acoustic equipment have made Sennheiser a world-leading company in this field.

Please take a few moments to read these instructions carefully, as we want you to enjoy your new Sennheiser product quickly and to the fullest.

Contents

The EM 550 G2 twin receiver	40
The channel bank system	40
Safety instructions	41
Delivery includes	41
Areas of application	42
Overview of operating controls	43
Indications and displays	44
Indications and displays of the receivers	44
Remote displays of an ew 500 G2 transmitter	44
Preparing the receiver for use	46
Mounting the receiver feet	46
Connecting the antennas	46
Connecting and mounting remote antennas	46
Daisy-chaining up to eight twin receivers	47
Connecting the mains cable	47
Connecting the amplifier/mixing console	48
Service interfaces	48
Mounting the twin receiver into a 19" rack	48
Mounting the antennas	48
Using the twin receiver	50
Switching the twin receiver on/off	50
Connecting the headphones/adjusting the volume	50
Activating/deactivating the lock mode	50
The operating menu	51
The buttons	51
Overview of menus	51
Working with the operating menu	52
Operating menu of the receiver RX A or RX B of the twin receiver	53
Adjustment tips for the operating menu	56
Switching between channel banks	56
Switching between the channels in a channel bank	56
Selecting the frequencies to be stored in the channel bank "U"	56
Scanning the channel banks for free channels	57
Multi-channel operation	58
Adjusting the audio output level	58
Adjusting the squelch threshold	58
Doing the soundcheck	59
Selecting the standard display	60
Entering a name	60
Loading the factory-preset default settings	61
Activating/deactivating the pilot tone evaluation	61
Activating/deactivating the lock mode	61
Using the equalizer	62
Adjusting the contrast of the graphic display	62
Exiting the operating menu	62
Troubleshooting	63
Error checklist	63
Recommendations and tips	64
Care and maintenance	64
Additional information	65
HDX noise reduction	65
Wireless transmission systems	65
Squelch	66
Diversity reception	67
Specifications	68
Connector assignment	69
Accessories	69

The EM 550 G2 twin receiver

The EM 550 G2 twin receiver consists of two complete true diversity receivers in a single 19" rack housing. The two receivers can be operated independently from each other. The EM 550 G2 has an integrated antenna splitter, enabling you to daisy-chain up to eight twin receivers.

The EM 550 G2 can be combined with transmitters of the ew 500 G2 series to make high-quality state-of-the-art RF transmission systems for professional applications. The transmitters and the twin receiver have a high level of operational reliability and are extremely user-friendly. The excellent transmission reliability is based on the use of

- further optimized PLL synthesizer and microprocessor technology,
- the HDX noise reduction system,
- the pilot tone squelch control,
- the true diversity technology (rack-mount receiver only),
- and the scan function for scanning the channel banks for free channels.

The channel bank system

The twin receiver is available in five UHF frequency ranges with 1,440 receiving frequencies per frequency range. Please note: Frequency usage is different for each country. Your Sennheiser agent will have all the necessary details on the available legal frequencies for your area.

Range A: 518 to 554 MHz
 Range B: 626 to 662 MHz
 Range C: 740 to 776 MHz
 Range D: 786 to 822 MHz
 Range E: 830 to 866 MHz

Each receiver of the EM 550 G2 has nine channel banks with up to 20 switchable channels each.

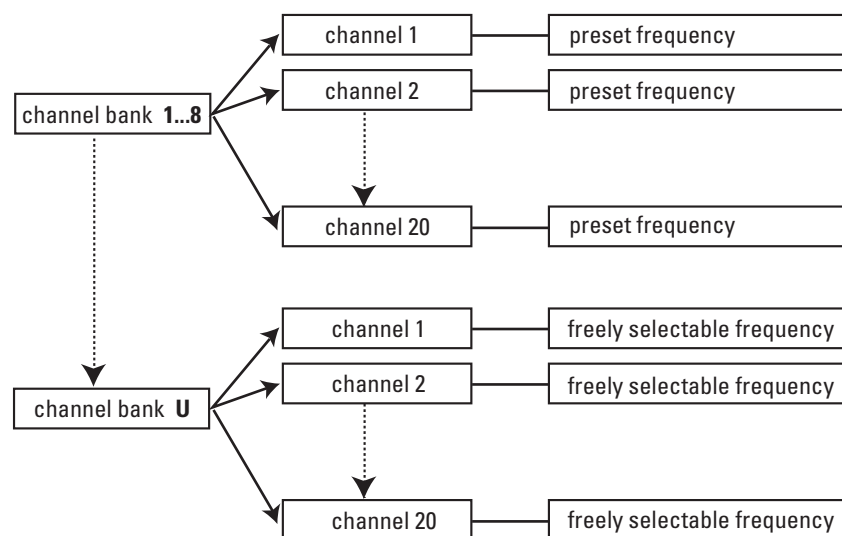

Each of the channels in the channel banks "1" to "8" has been factory-preset to a receiving frequency (see enclosed frequency table). These receiving frequencies cannot be changed but have been preset so that e.g. country-specific regulations on frequency usage are taken into account.

The channel bank "U" (user bank) allows you to store your selection out of 1,440 receiving frequencies that are freely selectable within the preset frequency range.

Safety instructions

Never open an electronic unit! If units are opened by customers in breach of this instruction, the warranty becomes null and void.

Keep the unit away from central heating radiators and electric heaters. Never expose it to direct sunlight.

Use the unit in dry rooms only.

Use a damp cloth for cleaning the unit. Do not use any cleansing agents or solvents.

Attention! High Volume!



This is a professional transmission system. Commercial use is subject to the rules and regulations of the trade association responsible. Sennheiser, as the manufacturer, is therefore obliged to expressly point out possible health risks arising from use.

The sound pressure at the headphone outputs of the twin receiver may exceed 85 dB(A). 85 dB(A) is the sound pressure corresponding to the maximum permissible volume which is by law (in some countries) allowed to affect your hearing for the duration of a working day. It is used as a basis according to the specifications of industrial medicine. Higher volumes or longer durations can damage your hearing. At higher volumes, the duration must be shortened in order to prevent damage. The following are sure signs that you have been subjected to excessive noise for too long a time:

- You can hear ringing or whistling sounds in your ears.
- You have the impression (even for a short time only) that you can no longer hear high notes.

Delivery includes

The packaging contains the following items:



- 1 EM 550 G2 twin receiver
- 1 mains cable
- 2 telescopic antennas
- 1 rack adapter
- Instructions for use

Areas of application

The EM 550 G2 twin receiver can be combined with transmitters of the ew 500 G2 series (SK 500 G2 bodypack transmitter, SKM 500 G2 radiomicrophone or SKP 500 G2 plug-on transmitter). The transmitters are available in the same five UHF frequency ranges and are equipped with the same channel bank system with factory-preset frequencies. An advantage of the factory-preset frequencies is that

- a transmission system is ready for immediate use after switch-on,
- several transmission systems can be operated simultaneously on the preset frequencies without causing intermodulation interference.

Together with a matching transmitter and a microphone, the receiver is suitable for the following areas of applications:

Transmitter and suitable accessories (to be ordered separately)		Area of application
	with ME 2 clip-on microphone (condenser, omni-directional)	Theater, presentations
	with ME 4 clip-on microphone (condenser, cardioid)	Theater, PA applications
	with ME 3 headmic (condenser, super-cardioid)	Vocals, sports (aerobic)
	with instrument cable	Using instruments wirelessly
	with MD 835 microphone head (dynamic, cardioid)	Speech, vocals
	with MD 845 microphone head (dynamic, super-cardioid)	Vocals (high feedback rejection)
	with ME 865 microphone head (condenser, super-cardioid)	Vocals, presentations (high feedback rejection)
	with MMD 935 microphone head ¹⁾ (dynamic, cardioid)	Vocals (in venues with high ambient noise levels)
	Suitable microphones (to be ordered separately): <ul style="list-style-type: none"> • Dynamic microphones • Condenser microphones with internal power supply • Condenser microphones with 48 V phantom powering 	Speech, vocals, presentations

¹⁾ MMD 935 only available as optional microphone head

Overview of operating controls

The EM 550 G2 consists of two complete receivers (RX A and RX B) in a 19" rack housing. The two receivers can be operated independently from each other, therefore all operating controls are available separately for each receiver.

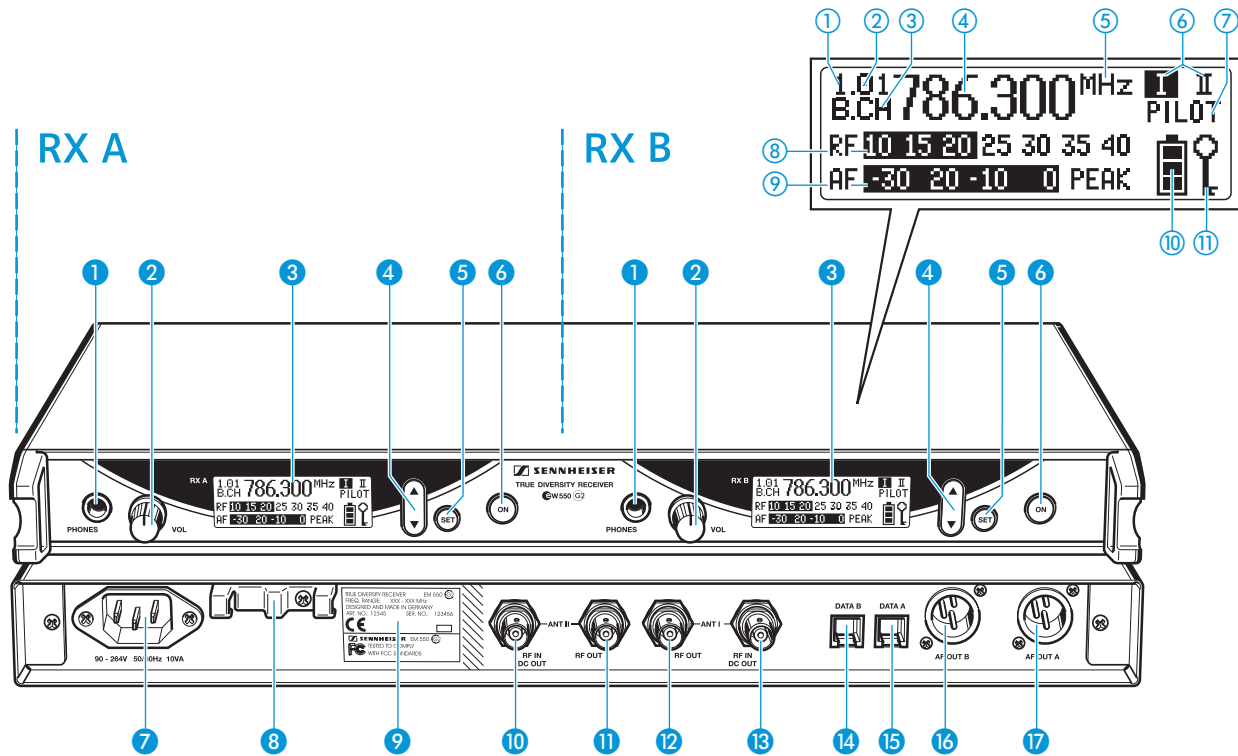

Operating controls

- ① Headphone output (PHONES), 1/4" (6.3 mm) jack socket
- ② Headphone volume control (VOL)
- ③ Graphic display, backlit
- ④ ▲/▼ rocker button, backlit
- ⑤ SET button, backlit
- ⑥ ON button, backlit (serves as the ESC (cancel) key in the operating menu)
- ⑦ 3-pin IEC mains connector
- ⑧ Cable grip for mains cable
- ⑨ Type plate
- ⑩ BNC socket, antenna input II (ANT II – RF IN, DC OUT)
- ⑪ BNC socket, cascading output II (ANT II – RF OUT)
- ⑫ BNC socket, cascading output I (ANT I – RF OUT)
- ⑬ BNC socket, antenna input I (ANT I – RF IN, DC OUT)
- ⑭ Service interface B (DATA B)
- ⑮ Service interface A (DATA A)
- ⑯ XLR-3M socket (male) for AF output B, balanced (AF OUT B)
- ⑰ XLR-3M socket (male) for AF output A, balanced (AF OUT A)

Graphic display panel

- ① Display for the current channel bank "1...8, U"
- ② Display for the current channel number "1...20"
- ③ "B.CH" – abbreviation for channel bank and channel number
- ④ Alphanumeric display
- ⑤ "MHz" – appears when the frequency is displayed
- ⑥ Diversity display (antenna I or antenna II active)
- ⑦ "PILOT" display (pilot tone evaluation is activated)
- ⑧ Level display for received RF signal "RF"
- ⑨ Level display for received audio signal "AF", with "PEAK" warning
- ⑩ 4-step transmitter battery status display
- ⑪ Lock mode icon (lock mode is activated)

Note:

For further illustrations and examples of the different standard displays, please refer to the section "Selecting the standard display" on page 60.

Indications and displays

Each receiver of the EM 550 G2 provides information on its own operating states and those of the received ew 500 G2 transmitter (remote displays).

Indications and displays of the receivers

"PILOT" display

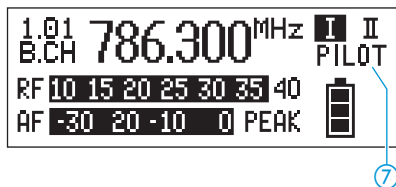

The "PILOT" display ⑦ appears on the display panel when the pilot tone evaluation is activated (see "Activating/deactivating the pilot tone evaluation" on page 61).

Diversity display

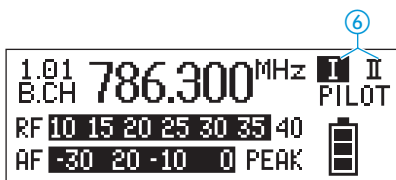

The receivers operate on the true diversity principle (see "Diversity reception" on page 67).

The diversity display ⑥ indicates whether diversity section I (i.e. antenna 1) or diversity section II (i.e. antenna 2) is active.

Button backlighting

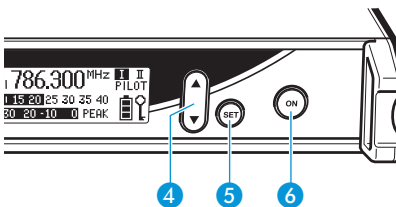

During standby operation, the ON button ⑥ is backlit in red. When the receiver is switched on, the SET button ⑤ and the ▲/▼ button ④ are additionally backlit in green.

Remote displays of an ew 500 G2 transmitter

Transmitter battery status indication

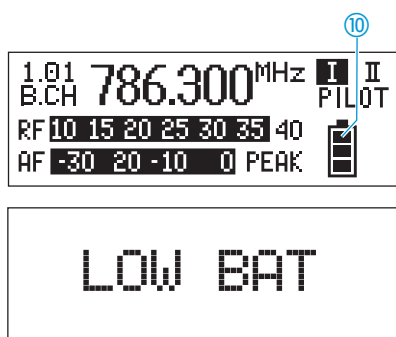

The 4-step transmitter battery status display ⑩ provides information on the remaining battery/accupack capacity of the received ew 500 G2 transmitter:

3 segments:	capacity approx. 100 %
2 segments:	capacity approx. 70 %
1 segment:	capacity approx. 30 %

Battery icon flashing LOW BAT

In addition, the text "LOW BAT" (backlit in red) flashes in alternation with the standard display.

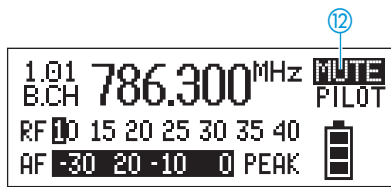

"MUTE" display

The "MUTE" display 12 appears on the display panel and the backlighting of the standard display switches from green to red. In addition, the text "MUTE" flashes in alternation with the standard display when

- the RF signal of the received transmitter is too weak,
- the received transmitter has been muted (with the pilot tone transmission or evaluation activated).

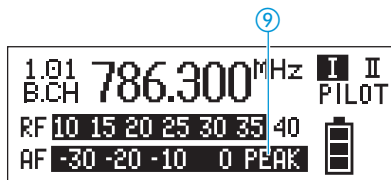

Modulation display

The level display for audio signal "AF" shows the modulation of the received transmitter.

When the transmitter's audio input level is excessively high, the receiver's level display for audio signal "AF" 9 shows full deflection.

When the transmitter is overmodulated frequently or for an extended period of time, the text "PEAK" (backlit in red) flashes in alternation with the standard display.

Preparing the receiver for use

Mounting the receiver feet

To ensure that the receiver cannot slip on the surface on which it is placed, four self-adhesive soft rubber feet are supplied.

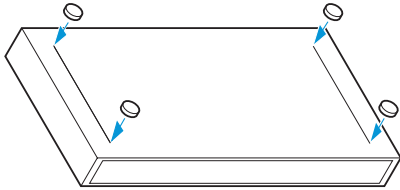

- ▶ Ensure that the base of the receiver is clean and free from grease before mounting the rubber feet.
- ▶ Fix the rubber feet to the base of the receiver by peeling of the safety paper and fitting them as shown in the diagram on the left.

Attention!

Some furniture surfaces have been treated with varnish, polish or synthetics which might cause stains when they come into contact with other synthetics. Despite a thorough testing of the synthetics used by us, we cannot rule out the possibility of staining.

Connecting the antennas

The supplied telescopic antennas can be mounted quickly and easily and are suitable for all applications where – good reception conditions provided – a wireless transmission system is to be used without a large amount of installation work.

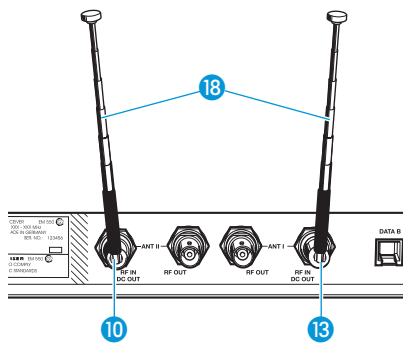

- ▶ Connect the telescopic antennas 18 to the BNC sockets 10 and 13 at the rear of the receiver.
- ▶ Pull the telescopic antennas out and align them upwards in a V-shape.

Connecting and mounting remote antennas

When the receiver position is not the best antenna position for optimum reception, you can use remote antennas. These are available as accessories.

- ▶ Connect the remote antennas to the BNC sockets 10 and 13 at the rear of the receiver. For connecting the antennas, use RG 58 co-axial cable. Ready made up antenna cables from Sennheiser are available as accessories with lengths of 1 m, 5 m and 10 m (see "Accessories" on page 69).



Attention!

To supply an active directional antenna (e.g. A 12 AD-UHF for the UHF range) or an antenna booster (e.g. AB 1), a direct voltage (which cannot be switched off) is output via the BNC sockets. If you use antennas from other manufacturers, take into account that these must be installed with direct voltage decoupling, i.e. isolated. The output voltage supply is short-circuit proof. An active antenna connected to this supply increases the current consumption of the overall unit.

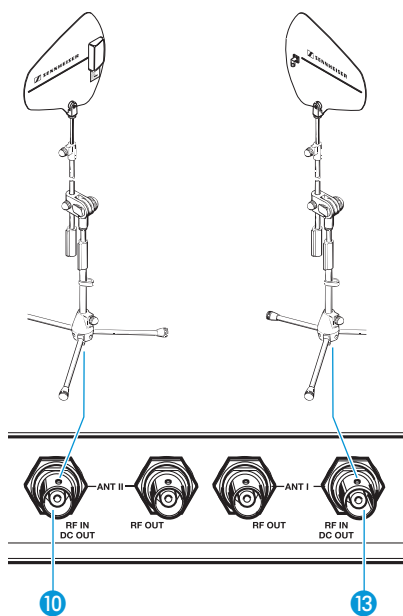

Essential notes on mounting remote antennas:

- Position antennas in the same room in which the transmission takes place!
- Maintain a minimum distance of 50 cm from metal objects (including reinforced-concrete walls)!
- Maintain a minimum distance of 1 m between receiving antennas!

Daisy-chaining up to eight twin receivers

The twin receivers feature an integrated antenna splitter so that up to eight twin receivers can be daisy-chained without any additional antenna splitters being required. Only daisy-chain receivers which operate in the same frequency range (see "The channel bank system" on page 40).

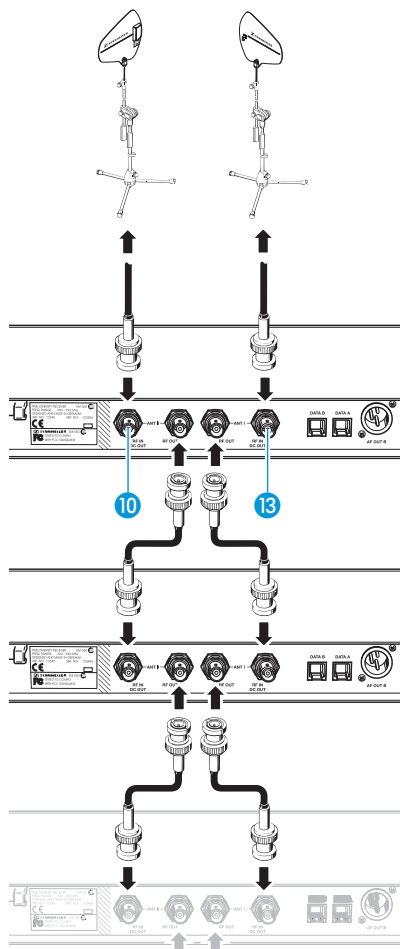

- ▶ Connect the two supplied telescopic antennas or two remote antennas (optional accessories) to the BNC sockets 10 and 13 at the rear of the first twin receiver.
- ▶ Use BNC cables to daisy-chain the twin receivers as shown in the diagram on the left.

Note:

To supply an active directional antenna, a direct voltage (which cannot be switched off) is output via the BNC sockets 10 and 13 of the twin receivers. For optimum reception quality, we recommend limiting the number of daisy-chained twin receivers to 8.

Connecting the mains cable

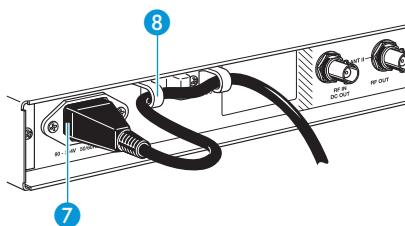

Use the mains cable to connect the twin receiver to the mains (90–264 V AC, 50–60 Hz).

- ▶ Pass the mains cable through the cable grip 8.
- ▶ Plug the mains cable into socket 7.

Connecting the amplifier/mixing console

The two audio outputs of the twin receiver are available as transformer balanced XLR-3M sockets. You can connect an amplifier or a mixing console to each audio output.

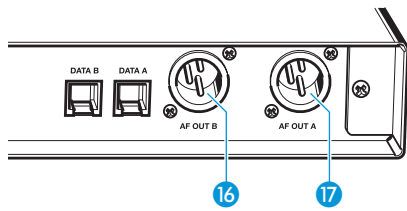

- ▶ Connect the amplifier/mixing console to the XLR-3M sockets AF OUT B **16** (receiver RX B) or AF OUT A **17** (receiver RX A).
- ▶ Via the operating menu, adapt the level of the audio output (AF OUT A and/or AF OUT B) to the input of the amplifier/mixing console (see "Adjusting the audio output level" on page 58).

Service interfaces

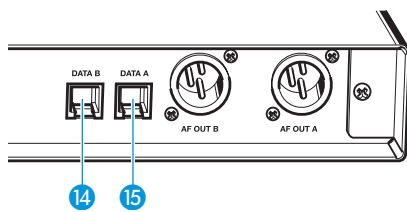

The two service interfaces DATA B **14** and DATA A **15** are only required for servicing purposes.

Mounting the twin receiver into a 19" rack

For mounting the twin receiver into a 19" rack, use the supplied GA 2 rack adapter. The GA 2 rack adapter consists of:

- 2 rack mount "ears" **19**
- 4 recessed head screws M 3x6

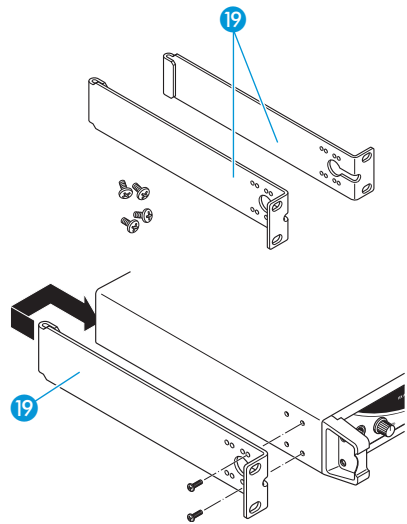

- ▶ Hook the two rack mount "ears" **19** to the rear panel of the twin receiver.
- ▶ Secure the rack mount "ears" to the twin receiver using two of the supplied recessed head screws (M 3x6) respectively.
- ▶ Slide the twin receiver into the 19" rack.
- ▶ Secure the rack mount "ears" to the rack.

Mounting the antennas

When rack-mounting the twin receiver, use the GA 3030 AM antenna mount (optional accessory) for mounting the telescopic antennas to the front of the GA 2 rack adapter. The GA 3030 AM antenna mount consists of:

- 2 BNC extension cables (screw-in BNC socket **20** to BNC connector **21**)
- 2 antenna holders **22**
- 2 plain washers
- 2 nuts

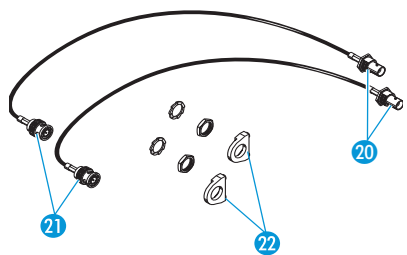

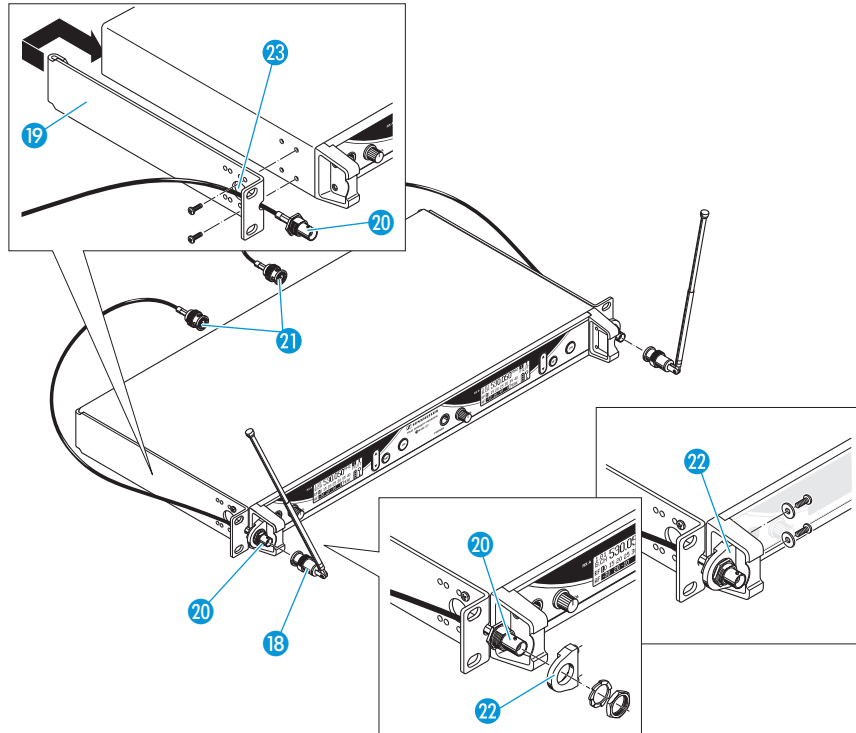

- ▶ Guide the BNC cable with the BNC connector 21 through the hole 23 on the rack mount "ear".
- ▶ Hook the two rack mount "ears" 19 to the rear panel of the twin receiver.
- ▶ Secure the rack mount "ears" to the twin receiver using two of the supplied recessed head screws (M 3x6) respectively.
- ▶ Screw the two BNC sockets 20 to the antenna holders 22 using the supplied plain washers and nuts.
- ▶ Screw the two antenna holders 22 to the handles of the twin receiver.
- ▶ Connect the two BNC connectors 21 to the BNC sockets 10 (ANT II) and 13 (ANT I) at the rear of the twin receiver.
- ▶ Slide the twin receiver into the 19" rack.
- ▶ Secure the rack mount "ears" to the rack.
- ▶ Connect the telescopic antennas 18 to the BNC sockets 20.
- ▶ Pull the telescopic antennas out and align them upwards in a V-shape.

Note:

Use remote antennas (available as accessories) when the receiver position is not the best antenna position for optimum reception.

Using the twin receiver

Switching the twin receiver on/off

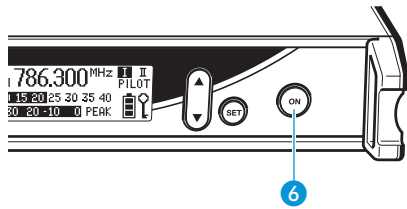

Each receiver of the EM 550 G2 is switched on and off separately with the **ON** button. The receivers can only be switched off when the standard display is shown on the display panel. When in the operating menu, briefly pressing the **ON** button will cancel your entry (ESC function) and return you to the standard display with the last stored settings.

- ▶ Press the **ON** button **6** to switch the receiver on.
- ▶ To switch the receiver off, press the **ON** button until "OFF" appears on the display.

Connecting the headphones/adjusting the volume

Each receiver of the EM 550 G2 has its own separate headphone output **1** for monitoring the audio signal.

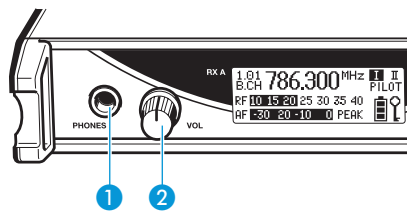

- ▶ Connect headphones with a 1/4" (6.3 mm) jack plug to the headphone output (PHONES) **1**.

Attention! High volume!

Even short exposure to high volume levels will damage your hearing! Set the volume for the connected headphones to the minimum before putting the headphones on.

- ▶ First, set the volume control **2** to the lowest volume by turning it to the left as far as possible. Then gradually turn up the volume.

Volume up? – NO!

When people use headphones, they tend to choose a higher volume than with loudspeakers. Listening at high volume levels for long periods can lead to permanent hearing defects. Please protect your hearing, Sennheiser headphones have an excellent sound quality even at low volumes.

Activating/deactivating the lock mode

Each receiver of the EM 550 G2 has a lock mode that can be activated or deactivated via the operating menu (see "Activating/deactivating the lock mode" on page 61). The lock mode prevents that the receiver is accidentally programmed or switched off during operation.

The operating menu

The operating menu is the same for both receivers of the EM 550 G2 and can be used almost intuitively. To ensure that adjustments to the settings can be made quickly and "without looking", the necessary operating steps for the twin receiver and the ew 500 G2 transmitters are similar.

The buttons

Buttons	Mode	To...
ON	Standard display	switch the receiver on and off
	Operating menu	cancel the entry and return to the standard display
	Setting mode	cancel the entry and return to the standard display
SET	Standard display	get into the operating menu
	Operating menu	get into the setting mode of the selected menu
	Setting mode	store the settings and return to the top menu level
▲/▼	Standard display	without function
	Operating menu	change to the previous menu (▲) or change to the next menu (▼)
	Setting mode	adjust the setting of the selected menu: option (▲/▼)

Overview of menus

Display	Function of the menu
Bank	Switching between channel banks
Channel	Switching between the channels in a channel bank
Tune	Setting a receiving frequency for the channel bank "U" (user bank)
Scan	Scanning the channel banks for free channels
AF Out	Adjusting the audio output level
Squelch	Adjusting the squelch threshold
Soundcheck	Doing the soundcheck
Display	Selecting the standard display
Name	Entering a name
Reset	Loading the factory-preset default settings
Pilot	Activating/deactivating the pilot tone evaluation
Lock	Activating/deactivating the lock mode
Equalizer	Changing the frequency response of the audio signal
LCD Contr	Adjusting the contrast of the graphic display
Exit	Exiting the operating menu and returning to the standard display

Working with the operating menu

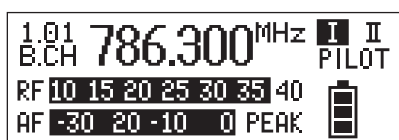

By way of example of the "Tune" menu, this section describes how to use the operating menu. The operating steps for adjusting the settings via the menu are similar for both receivers of the EM 550 G2.

After switching the receiver RX A or RX B on, the standard display is shown on the display panel.

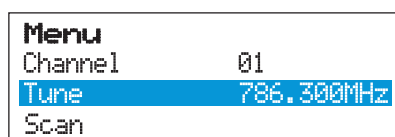

Getting into the operating menu

- ▶ Press the **SET** button to get from the standard display into the operating menu. The last selected menu and its current setting are displayed with a background.



Selecting a menu

- ▶ Press the **▲/▼** rocker button to select a menu.
- ▶ Press the **SET** button to get into the setting mode of the selected menu. The name of the menu and its current setting are displayed.

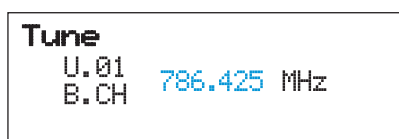

Adjusting a setting

- ▶ Press the **▲/▼** rocker button to adjust the setting. The new setting becomes effective immediately. By briefly pressing the **▲/▼** rocker button, the display jumps either forwards or backwards to the next setting. In the "Channel", "Tune" and "Name" menu, the **▲/▼** rocker button features a "fast search" function. If you hold down a button, the display cycles continuously, allowing you to get fast and easily to your desired setting.



Storing a setting

- ▶ Press the **SET** button to store the setting. "Stored" appears on the display, indicating that the setting has been stored. The display then returns to the top menu level.

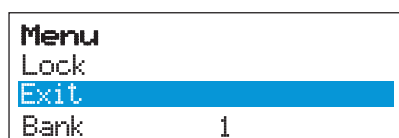

Exiting the operating menu

- ▶ Select the "Exit" menu to exit the operating menu and to return to the standard display. When in the operating menu, briefly pressing the **ON** button will cancel your entry (ESC function) and return you to the standard display with the last stored settings.

Operating menu of the receiver RX A or RX B of the twin receiver

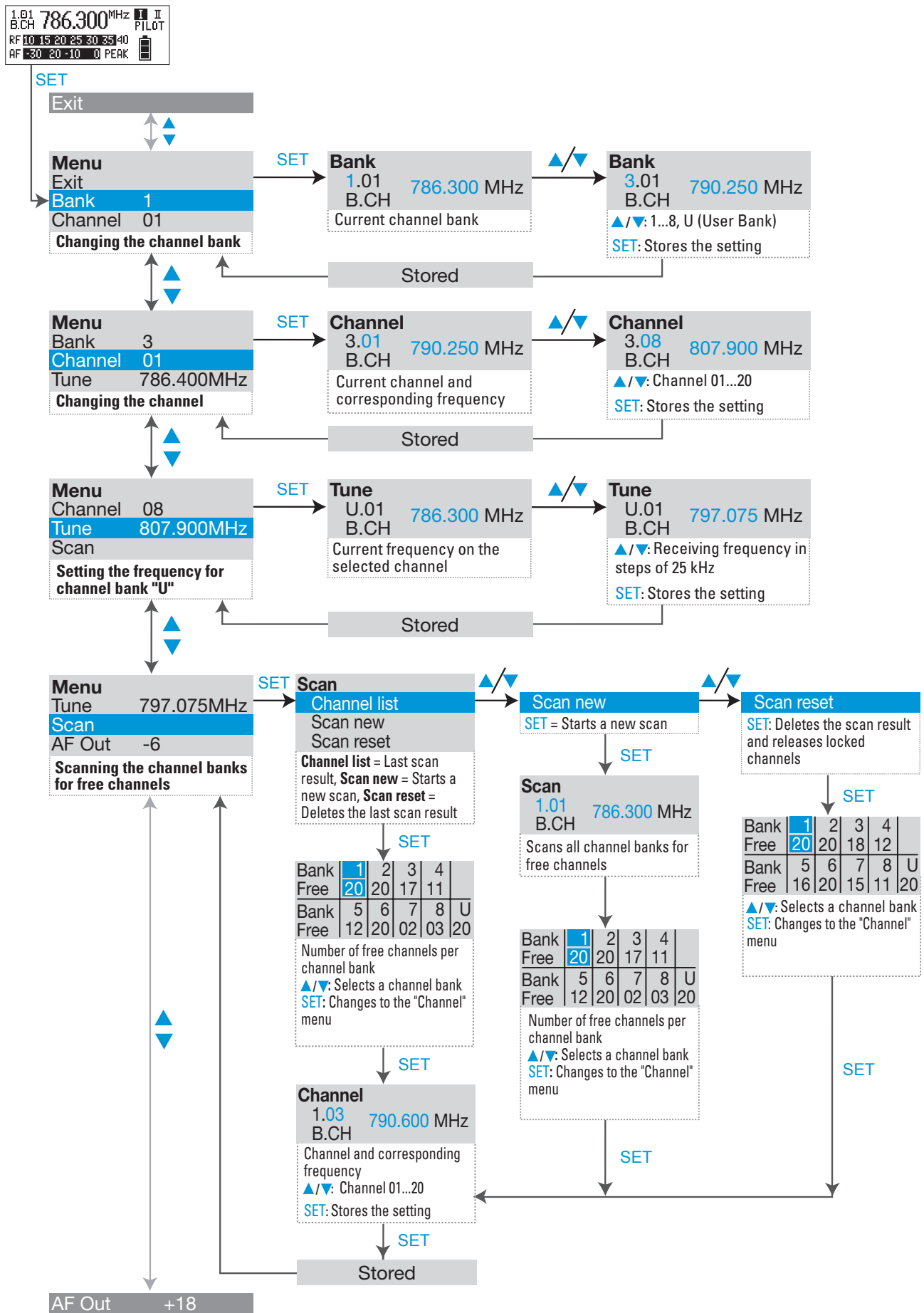

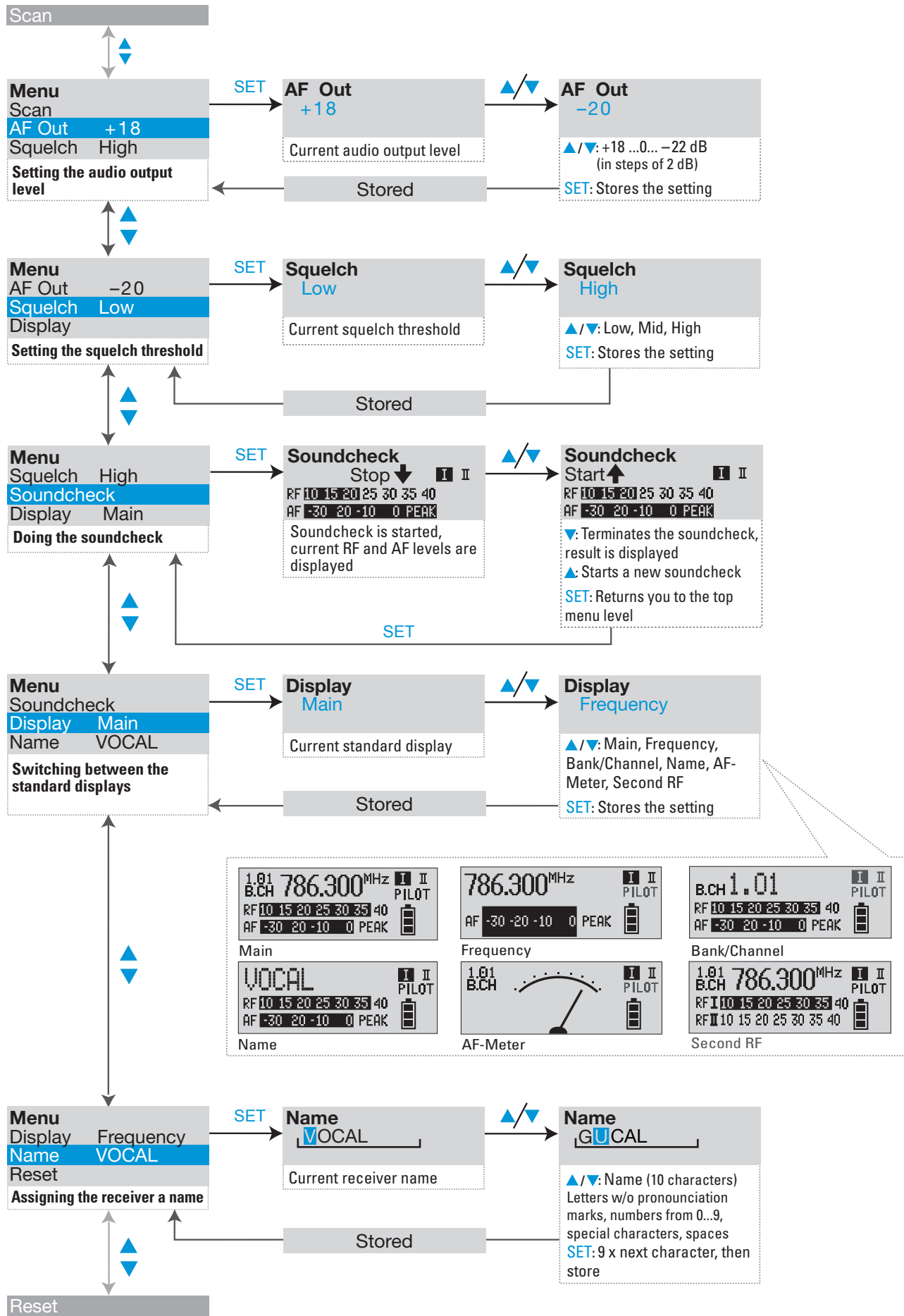

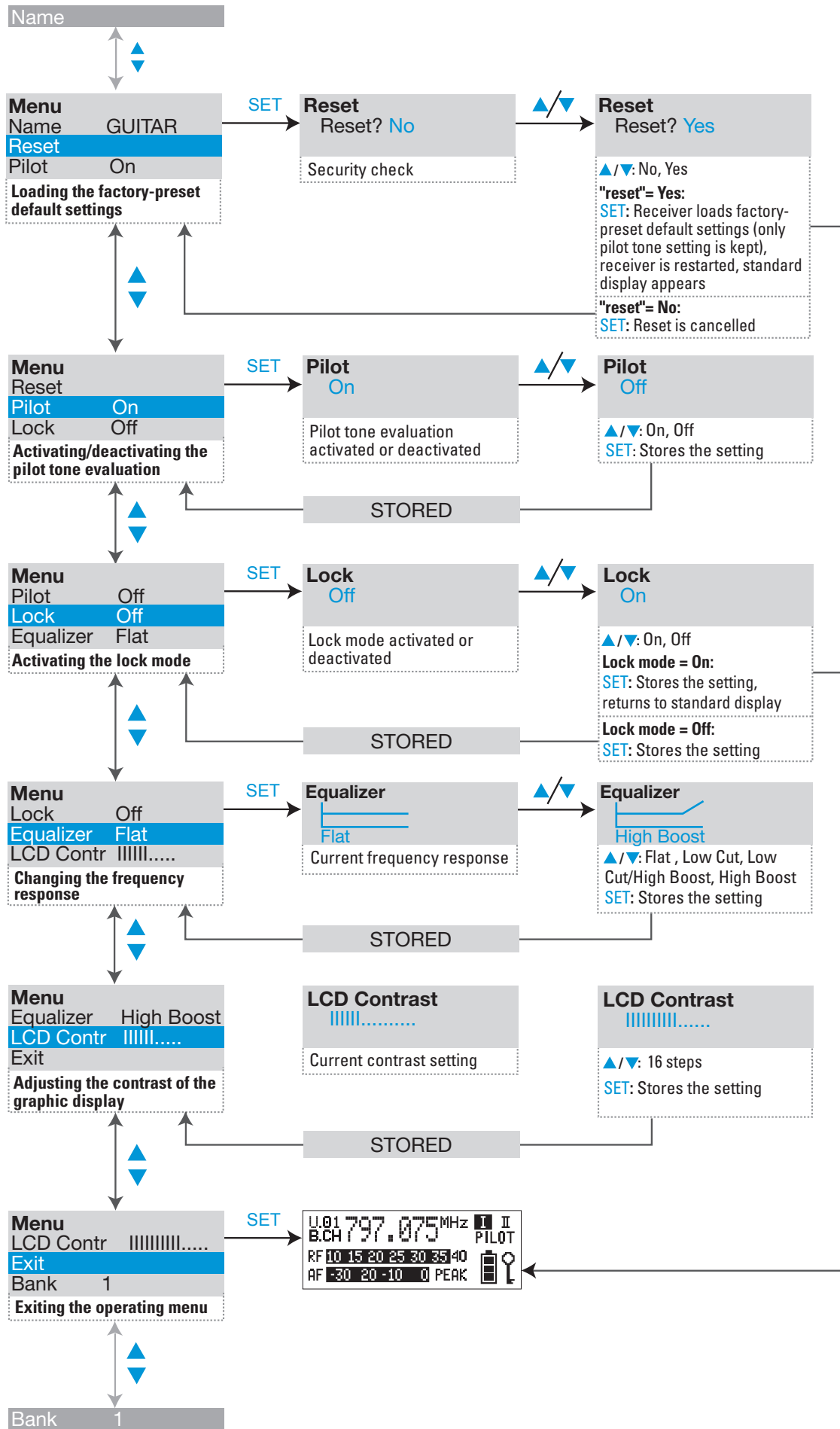

Adjustment tips for the operating menu

The following adjustment tips refer to the operating menus of both receivers of the EM 550 G2.

Switching between channel banks

Bank

Each receiver of the EM 550 G2 has nine channel banks between which you can switch via the "Bank" menu. The channel banks "1" to "8" have up to 20 switchable channels that are factory-preset to a receiving frequency (see "The channel bank system" on page 40). The channel bank "U" (user bank) has up to 20 switchable channels to store your selection out of 1,440 receiving frequencies that are freely selectable within the preset frequency range.

When switching from one channel bank to another, the channel with the lowest channel number is automatically displayed. If, during the last scan of this channel bank, an interfering frequency was detected on the channel with the lowest channel number, the receiver display panel automatically displays the next free channel (see below).

Switching between the channels in a channel bank

Channel

Via the "Channel" menu, you can switch between the different channels in a channel bank. When switching between the channels, please observe the following:

- Always set the transmitter and the receiver of a transmission link to the same channel.
- After scanning the channel banks (see "Scanning the channel banks for free channels" on page 57), only the free channels can be chosen on the receiver. Set the transmitter and the receiver to one of the free channels.

Selecting the frequencies to be stored in the channel bank "U"

Tune

Via the "Tune" menu, you can select the frequencies to be stored in the channel bank "U" (user bank).

When you have selected one of the channel banks "1" to "8" and then select the "Tune" menu, the receiver automatically switches to channel 01 of the channel bank "U". In this case, "U.01" briefly appears on the display.

- ▶ Use the ▲/▼ rocker button to select the desired receiving frequency. Receiving frequencies are tunable in 25-kHz steps within a switching bandwidth of 36 MHz max. For intermodulation-free frequencies, please refer to the enclosed frequency table.

Scanning the channel banks for free channels

Scan

Before putting one or several transmission links into operation, you should scan the channel banks for free channels.

Scan

Channel list
Scan new
Scan reset

Bank	1	2	3	4	
Free	20	20	17	11	
Bank	5	6	7	8	U
Free	12	20	02	03	20

Channel

1.01 786.300 MHz
B.CH

Displaying a list of all free channels

Via the "Channel list" menu, you can display the number of free channels for all channel banks.

- ▶ Select the "Scan" menu.
- ▶ Select "Channel list" to display the last scan result. The illustrated list is an example list and may look different in other frequency ranges. The number of free channels is displayed for all channel banks.

- ▶ For further details, select a channel bank by using the ▲/▼ rocker button and then press the SET button. This gets you into the "Channel" menu where you can select a channel of this channel bank or display the frequency of a channel.

Starting the scan

- ▶ Before starting the scan, switch all transmitters of your system off, since channels used by switched-on transmitters will not be displayed as "free channels".
- ▶ Select the "Scan" menu.
- ▶ Select "Scan new" and confirm your selection by pressing the SET button.

Note:

The scanning process takes approx. 1 minute.

After the scan is completed, the number of free channels is displayed for all channel banks. Channels that are used or subject to interference are locked and cannot be selected. The same result is displayed when selecting the "Channel list" menu.

- ▶ For further details, select a channel bank by using the ▲/▼ rocker button and then press the SET button. This gets you into the "Channel" menu where you can select a channel of this channel bank or display the frequency of a channel.

Releasing locked channels

- ▶ Select the "Scan" menu.
- ▶ Select "Scan reset" and confirm your selection by pressing the SET button. The last scan result is deleted and all channels can now be selected again.

Scan

Channel list
Scan new
Scan reset

Bank	1	2	3	4	
Free	20	20	17	11	
Bank	5	6	7	8	U
Free	12	20	02	03	20

Scan

Channel list
Scan new
Scan reset

Bank	1	2	3	4	
Free	20	20	18	12	
Bank	5	6	7	8	U
Free	16	20	15	11	20

Multi-channel operation

Combined with ew 500 G2 transmitters, the receivers can form transmission links that can be used in multi-channel systems. For multi-channel operation, only use the free channels in a channel bank.

Before putting the transmission links into operation, we recommend performing an auto scan.

- ▶ Scan one of the two receivers of the EM 550 G2 for free channels.
- ▶ Select a channel bank with a sufficient number of free channels.
- ▶ Set all transmitter/receiver pairs in your multi-channel system to the free channels in this channel bank.

Bank	1	2	3	4	
Free	20	20	17	11	
Bank	5	6	7	8	U
Free	12	20	02	03	20

Adjusting the audio output level

AF Out

Via the "AF Out" menu, you can adjust the audio output level of each receiver of the EM 550 G2. The level can be adjusted in 22 steps. Adapt the level of the audio output (receiver RX A: AF OUT A or receiver RX B: AF OUT B) to the input of the connected unit. The following figures are a guide to the best settings:

Line level input:	0 to +18 dB
Microphone level input:	-22 to -6 dB

Adjusting the squelch threshold

Squelch

Both receivers are equipped with a squelch that can be adjusted via the "Squelch" menu. The squelch eliminates annoying noise when the transmitter is switched off. It also suppresses sudden noise when there is no longer sufficient transmitter power received by the receiver.

Note:

Before adjusting the squelch threshold to a different setting, set the volume on a connected amplifier to the minimum.

There are three possible squelch settings:

- Low = low
- Mid = middle
- High = high

Selecting the setting "Low" reduces the squelch threshold, selecting the setting "High" increases the squelch threshold. Adjust the squelch threshold – with the transmitter switched off – to the lowest possible setting that suppresses hissing noise.

IMPORTANT!

Notes:

If the squelch threshold is adjusted too high, the transmission range will be reduced. Therefore, always adjust the squelch threshold to the lowest possible setting.

When in the setting mode of the "Squelch" menu, pressing the ▼ button (DOWN) for more than three seconds will switch the squelch off. "Off" appears on the display. If no RF signal is being received, hissing noise will occur. This setting is for test purposes only.

Doing the soundcheck

Soundcheck

By doing a soundcheck, you can check the reception area for field strength gaps ("dropouts") which cannot be compensated for by the receiver's diversity circuitry. You can do the soundcheck without the help of another person.

- ▶ Switch the transmitter on.
- ▶ Select the "Soundcheck" menu. The soundcheck is started immediately.
- ▶ With the transmitter, walk up and down the transmission area.
- ▶ Press the ▼ button on the receiver to terminate the soundcheck and to display the result of the soundcheck. The level displays "RF" and "AF" will indicate the lowest RF and the highest AF level of the received transmitter.



Optimize the RF level by repositioning the receiving antennas.

The audio level should be as high as possible (max. 0 dB) without the level display for audio signal "AF" showing full deflection (see the section "Adjusting the sensitivity" in the operating manual of the transmitter).

If both receiving antennas are connected and aligned, the diversity displays I and II appear on the display panel.

If no transmitter is being received, the "MUTE" display appears on the display panel.

- ▶ To do another soundcheck (e.g. with an improved antenna arrangement, another transmitter position or a new transmitter sensitivity), press the ▲ button.

Selecting the standard display

Display

Via the "Display" menu, you can select the standard display:

Selectable standard display	Contents of the display
"Main" (standard display)	
"Frequency" (display of the frequency)	
"Bank/Channel" (display of the channel bank and channel number)	
"Name" (display of the freely selectable name)	
"AF meter" (graphic display of the AF level)	
"Second RF" (display of the RF levels of the two diversity sections)	

Entering a name

Name

Via the "Name" menu, you can enter a freely selectable name for the receiver. You can, for example, enter the name of the performer for whom the adjustments have been made.

The name can be displayed on the standard display and can consist of up to ten characters such as:

- letters (without pronunciation marks),
- numbers from 0 to 9,
- special characters e.g. () - . _ and spaces.

To enter a name, proceed as follows:

- ▶ Press the **SET** button to get into the setting mode of the "Name" menu. The first segment starts flashing on the display.
- ▶ With the **▲/▼** buttons you can now select a character. By briefly pressing a button, the display jumps either forwards or backwards to the next character. If you hold down a button, the display starts cycling continuously.

- ▶ Press the **SET** button to change to the next segment and select the next character.
- ▶ Have you entered the name completely? Press the **SET** button to store your setting and to return to the top menu level.

Loading the factory-preset default settings

Reset

Via the "Reset" menu, you load the factory-preset default settings. Only the selected setting for the pilot tone remains unchanged. After the reset, the receiver is restarted and the standard display is shown on the display panel.

Activating/deactivating the pilot tone evaluation

Pilot

Via the "Pilot" menu, you can activate or deactivate the pilot tone evaluation.

The pilot tone supports the receiver's squelch function (Squelch) and protects against interference due to RF signals from other units. The transmitter adds an inaudible signal, known as the pilot tone, to the transmitted signal. The receiver detects and evaluates the pilot tone, and is thus able to identify the signal of the matching transmitter and mute all others.

Transmitters of the ew 500 series (first generation) do not transmit a pilot tone and the receivers of the ew 500 series (first generation) cannot evaluate the pilot tone. Nevertheless, you can combine the EM 550 G2 receiver with a transmitter of the first generation. However, when combining units, please observe the following:

- With an ew 500 G2 transmitter and the ew 500 G2 receiver:
Activate the pilot tone function with both transmitter and receiver.
- With an ew 500 transmitter and the ew 500 G2 receiver or vice versa:
Deactivate the pilot tone function with the ew 500 G2 transmitter or receiver.

Activating/deactivating the lock mode

Lock

Via the "Lock" menu, you can activate or deactivate the lock mode.

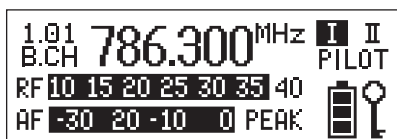

The lock mode prevents that the receiver is accidentally programmed or switched off during operation. The lock mode icon on the display indicates that the lock mode is activated.

To deactivate the lock mode, first press the **SET** button and then press the **▲/▼** buttons to select "Off". If you confirm your selection by pressing the **SET** button, the buttons can be operated as usual.

Using the equalizer

Equalizer

Via the "Equalizer" menu, you can change the treble and bass of the audio signal available at the audio output AF OUT A (receiver RX A) or AF OUT B (receiver RX B):

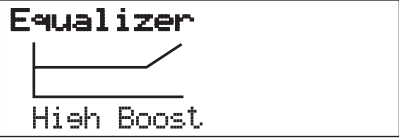
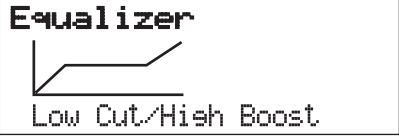
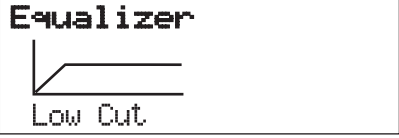
Selectable setting	Display
"Flat" (treble and bass of the output signal remain unchanged)	
"High Boost" (boosting the treble)	
"Low Cut/High Boost" (cutting the bass and boosting the treble)	
"Low Cut" (cutting the bass)	

Adjusting the contrast of the graphic display

LCD Contr

Via the "LCD Contr" menu, you can adjust the contrast of the graphic display in 16 steps.

Exiting the operating menu

Exit

Via the "Exit" menu, you can exit the operating menu and return to the standard display.

Troubleshooting

Error checklist

Problem	Possible cause	Possible solution
No operation indication	No mains connection	Check the connections of the mains cable
No RF signal	Transmitter and receiver are not on the same channel	Set transmitter and receiver to the same channel
	Transmitter is out of range	Check the squelch threshold setting (see "Adjusting the squelch threshold" on page 58) or reduce the distance between transmitter and receiving antenna
RF signal available, no audio signal, "MUTE" display appears on the display panel	Transmitter is muted ("MUTE")	Deactivate the muting function (see operating manual of the transmitter)
	Receiver's squelch threshold is adjusted too high	See "Adjusting the squelch threshold" on page 58
	Transmitter doesn't transmit a pilot tone	Switch the pilot tone transmission on the transmitter on or switch the pilot tone evaluation on the receiver off
	Transmitter sensitivity is adjusted too low	Adjust the transmitter sensitivity correctly
Audio signal has a high level of background noise	Receiver's AF output level is adjusted too low	See "Adjusting the audio output level" on page 58
	Transmitter sensitivity is adjusted too high	Adjust the transmitter sensitivity correctly
Audio signal is distorted	Receiver's AF output level is adjusted too high	See "Adjusting the audio output level" on page 58
No access to a certain channel	During scanning, an RF signal has been detected on this channel and the channel has been locked	See "Scanning the channel banks for free channels" on page 57
	During scanning, a transmitter of your system operating on this channel has not been switched off	See "Multi-channel operation" on page 58
During the soundcheck, only one diversity display (I or II) appears on the display panel	One of the antennas is not connected correctly	Check the antenna connections

If problems occur that are not listed in the above table or if the problems cannot be solved with the proposed solutions, please contact your local Sennheiser agent for assistance.

Recommendations and tips

... for optimum reception

- Transmission range depends to a large extent on location and can vary from about 10 m to about 150 m. There should be a "free line of sight" between transmitting and receiving antennas.
- If, with the twin receiver, reception conditions are unfavourable, you should use two remote antennas which are connected via antenna cable.
- To avoid overmodulating the receiver, observe a minimum distance of 5 m between transmitting and receiving antennas.
- Observe a minimum distance of 50 cm between receiving antennas and metal objects (such as cross members or reinforced-concrete walls).

... for multi-channel operation

- For multi-channel operation, you can only use the channels within a channel bank. Each of the channel banks "1" to "8" accommodates up to 20 factory-preset frequencies which are intermodulation-free. For alternative frequency combinations, please refer to the enclosed frequency table. The freely selectable frequencies can be selected via the "Tune" menu and can be stored in the channel bank "U".
- When using several transmitters simultaneously, interference can be avoided by maintaining a minimum distance of 20 cm between two transmitters.
- Use special accessories for multi-channel applications (see "Accessories" on page 69).

Care and maintenance

Use a slightly damp cloth to clean the twin receiver from time to time.

Note:

Do not use any cleansing agents or solvents.

Additional information

HDX noise reduction

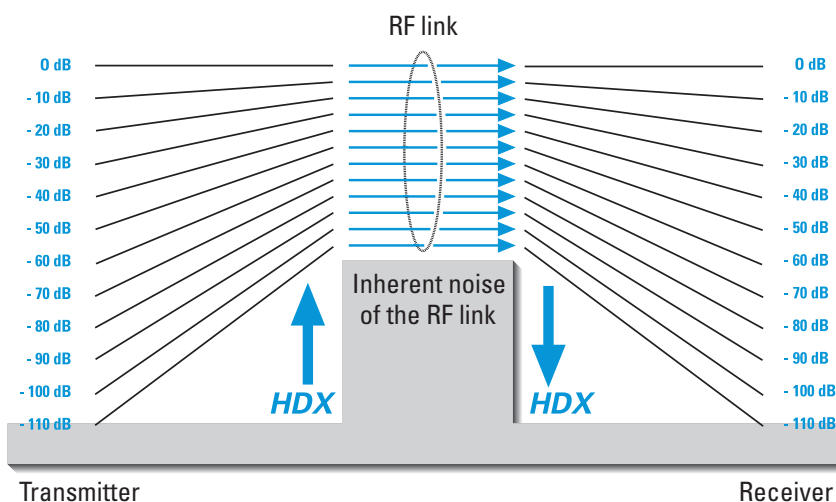

Progress you can hear:

The evolution wireless G2 series is equipped with HDX, the Sennheiser noise reduction system that reduces RF interference. It increases the signal-to-noise ratio in wireless audio transmission to more than 110 dB.

HDX is a wideband compander system which compresses the audio signal in the transmitter in a 2:1 ratio (related to dB) to lift it above the inherent noise floor of the RF link. A 110 dB dynamic range signal is thus transmitted with an effective dynamic range of only 55 dB, which is above the 60 dB noise floor of the RF link. In the receiver the signal is expanded in an identical and opposite way in a 1:2 ratio to restore the original signal, at the same time reducing the RF noise to below the noise floor of the receiver.

HDX has been specially developed for high quality radiomicrophone systems.

Note:

Only transmitters and receivers that are equipped with HDX can work correctly with each other. If non HDX equipment was mixed with HDX, the dynamic range would be drastically reduced and the transmission would sound blunt and flat. HDX is permanently active and cannot be switched off.

Wireless transmission systems

With the ew 500 G2 series, Sennheiser puts an end to cable tangles and enables complete freedom of movement. The systems operate exclusively in the UHF band. UHF transmission is extremely reliable and is far less prone to interference than the overcrowded VHF band – harmonics from mains units, fluorescent tubes, refrigerators, computers, etc. are virtually eliminated. Also indoor propagation of UHF radio waves is better than VHF so that the RF power can be kept low – this is also an advantage when using multi-channel systems. Finally, UHF frequency ranges are being approved all over the world for radiomicrophone usage – in some countries licence-free.

Squelch

Pilot tone squelch

The ew 500 G2 transmitters add a pilot tone to the audio signal. The receiver checks incoming audio signals to see if the pilot tone is present. In the absence of the pilot tone, the receiver's audio output will remain muted, even if a strong RF signal is present.

This prevents strong interfering signals from causing hissing noise in the receiver when the transmitters are switched off.

In order to benefit from this feature, the pilot tone function must be activated on both the transmitter and the receiver. The receiver's pilot tone function is factory-preset to "ON" (= activated).

Field strength-dependent squelch

Depending on the strength of the received RF signal, the receiver's audio output is opened or muted. Via the "Squelch" menu of the receiver, the squelch threshold can be adjusted in three steps (Low, Mid, High).

Diversity reception

The two receivers of the EM 550 G2 operate on the "true diversity" principle:

A receiving antenna receives not only the electromagnetic waves which reach it by a direct path, but also the reflections of these waves which are created in the room by walls, windows, ceilings and fittings. When these waves are superimposed, destructive interference occurs, which can also be called "field strength gaps". Repositioning the receiving antenna can bring a solution. With mobile transmitters, however (which all radiomicrophones are), the "field strength gap" will then occur with a different transmitter position. These "field strength gaps" can only be eliminated with true diversity receivers.

In true diversity, instead of one antenna and one receiver there are now two antennas and two receiver sections. The antennas are spatially separated. By means of a comparison circuit, the receiver section with the strongest RF signal is always switched to the common AF output. The risk of the occurrence of "field strength gaps" in both antennas at the same time is virtually nonexistent.

The receiver display panel shows the active diversity section (I or II) ^⑥.

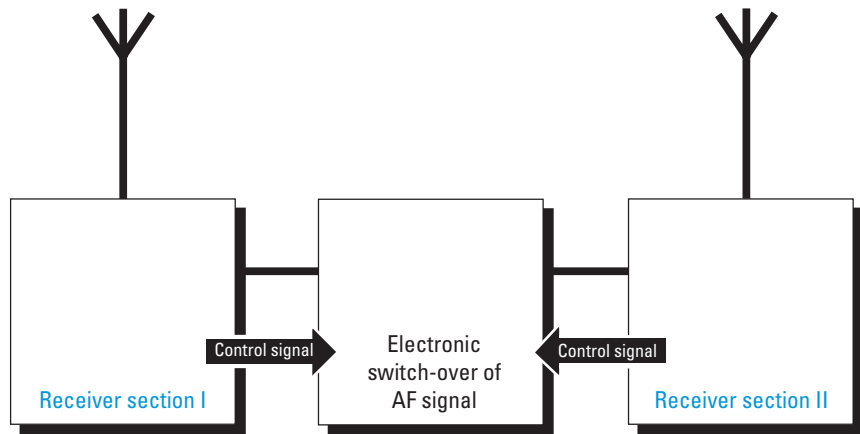
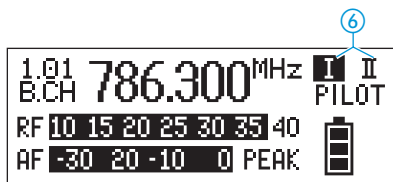

Specifications

RF characteristics

Modulation	wideband FM
Frequency ranges	518–554, 626–662, 740–776, 786–822, 830–866 MHz
Receiving frequencies	8 channel banks with up to 20 factory-preset channels each 1 channel bank with up to 20 freely selectable channels (1,440 frequencies, tunable in steps of 25 kHz)
Switching bandwidth	36 MHz
Nominal/peak deviation	±24 kHz / ±48 kHz
Frequency stability	≤ ±15 ppm
Receiver principle	true diversity
Sensitivity (with HDX, peak deviation)	typ. 1.5 µV at 52 dBA _{rms} S/N ratio
Adjacent channel rejection	≥ 70 dB
Intermodulation attenuation	≥ 70 dB
Blocking	≥ 80 dB
Squelch	4 steps: Off Low: 5 dBµV Mid: 15 dBµV High: 25 dBµV
Pilot tone squelch	can be switched off
Antenna inputs	2 BNC sockets (50 Ω)
Cascading outputs	2 BNC sockets (50 Ω) gain: 0 dB ±2 dB (related to antenna inputs)

AF characteristics

Noise reduction system	Sennheiser HDX
EQ presets (switchable, effect the line and monitor outputs):	
Preset 1: "Flat" AF frequency response	40–18,000 Hz
Preset 2: "Low Cut" Cut	approx. -3 dB at 200 Hz
Preset 3: "HiBoost" Boost	approx. +6 dB at 10,000 Hz
Preset 4: "Low Cut & Hi Boost" Cut Boost	approx. -3 dB at 200 Hz approx. +6 dB at 10,000 Hz
S/N ratio (at 1 mV and peak deviation)	≥ 115 dB(A) (AF OUT)
THD (at nominal deviation and 1 kHz)	≤ 0.9 %
AF output voltage (at peak deviation 1 kHz _{AF})	+18 dB _u to -22 dB _u , adjustable in steps of 2 dB (transformer balanced)
AF outputs	2 XLR-3M sockets

Overall unit

Temperature range	-10 °C to +55 °C
Power supply	90–264 V AC
Mains connector	3-pin; protection class I
Booster supply voltage	11 V DC, cannot be switched off
Max. booster current	≤ 150 mA (limited per antenna socket)
Power consumption	40 VA
Dimensions [mm]	436 x 215 x 43
Weight	approx. 3,500 g

Connector assignment

XLR-3F connector,
transformer balanced

1/4" (6.3 mm) stereo jack plug for
headphone output

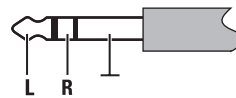
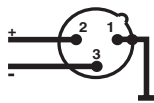

Accessories

GA 3030 AM	Antenna mount	
A 1031-U	UHF antenna, passive, omni-directional, can be mounted onto a stand	
A 12-AD	UHF-antenna, active, directional	
AB 2-A	UHF antenna booster, 10 dB gain powered via ASP 2/NT 1	518–554 MHz
AB 2-B		626–662 MHz
AB 2-C		740–776 MHz
AB 2-D		786–822 MHz
AB 2-E		830–866 MHz
GZL 1019-A1 / 5 / 10	Antenna cable with BNC connectors	1 m / 5 m / 10 m

Sennheiser electronic GmbH & Co. KG
30900 Wedemark, Germany
Phone +49 (5130) 600 0
Fax +49 (5130) 600 300
www.sennheiser.com

Printed in Germany

Publ. 12/03

90676/A01

Free Manuals Download Website

<http://myh66.com>

<http://usermanuals.us>

<http://www.somanuals.com>

<http://www.4manuals.cc>

<http://www.manual-lib.com>

<http://www.404manual.com>

<http://www.luxmanual.com>

<http://aubethermostatmanual.com>

Golf course search by state

<http://golfingnear.com>

Email search by domain

<http://emailbydomain.com>

Auto manuals search

<http://auto.somanuals.com>

TV manuals search

<http://tv.somanuals.com>