

# RCA

## Television User's Guide

Changing Entertainment. Again.

Please read this manual before  
operating this product for the  
first time.

TOCOM 15775710



**Model: CR20310**

# Important Information

---

## WARNING

To reduce the risk of fire or electric shock, do not expose this TV to rain or moisture.

## WARNING

RISK OF ELECTRIC SHOCK  
DO NOT OPEN

To reduce the risk of electric shock, do not remove cover (or back). No user serviceable parts inside. Refer servicing to qualified service personnel.



This symbol indicates "dangerous voltage" inside the product that presents a risk of electric shock or personal injury.



This symbol indicates important instructions accompanying the product.

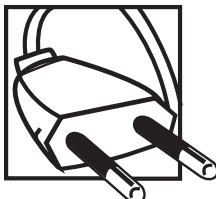

**Caution:** To prevent electric shock, insert plug firmly into outlet.

**Power Consumption:** 110-220V ~ 50/60 Hz A.C.  
70 W (for model CR20310)

**If fixed (non-moving) images are left on the screen for long periods, they may be permanently imprinted on the picture tube. Such images include network logos, phone numbers, and video games. This damage is not covered by your warranty. Extended viewing of channels displaying these images should be avoided.**

## Chapter 1: Setup and Connections

<b>Things to Consider Before You Connect</b> .....	4
Protect Against Power Surges .....	4
Protect Components from Overheating .....	4
Position Cables Properly to Avoid Audio Interference .....	4
Important Stand and Base Safety Information .....	4
Use Indirect Light .....	4
<b>Choose Your Connection</b> .....	5
Cables Needed to Connect Components to Your TV .....	5
Connection: TV Only .....	6
Connection: TV + VCR .....	6
Connection: TV + VCR + Satellite Receiver .....	7
<b>The Front of Your TV</b> .....	8
<b>Turn on the TV</b> .....	9
<b>Automatic Tuning</b> .....	9
<b>The Buttons on the Remote Control</b> .....	10

## Chapter 2: Menus and Features

<b>The Point and Select Method</b> .....	12
<b>TV Main Menu</b> .....	12
<b>The Picture Menu</b> .....	12
<b>Sound Menu</b> .....	13
<b>Channel Menu</b> .....	14
<b>Tuning Menu</b> .....	14
<b>Setup Menu</b> .....	15
Using Closed Captioning .....	16
<b>Channel Marker</b> .....	16

## Chapter 3: Other Information

<b>Troubleshooting</b> .....	18
<b>Care and Cleaning</b> .....	20
<b>Index</b> .....	21

**This page left blank intentionally**

# Connections & Setup

## Chapter Overview:

- Things to Consider Before You Connect
- Choose Your Connection
- The Front of Your TV
- Put Batteries in the Remote
- How to Use the Remote Control to Complete the Setup
- Buttons on the Remote Control

**NOTE:** Illustrations are for representation only. Your product and on-screen displays might differ.

**Changing Entertainment. Again.**



## Things to Consider Before You Connect

### Protect Against Power Surges

- Connect all components before you plug any of their power cords into the wall outlet.
- Turn off the TV and/or component before you connect or disconnect any cables.
- Make sure all antennas and cables are properly grounded. Refer to the Important Safeguards sheet packed with your TV.

### Protect Components from Overheating

- Don't block ventilation holes on any of the components. Arrange the components so that air can circulate freely.
- Don't stack components.
- When you place components in a stand, make sure you allow adequate ventilation.
- If you connect an audio receiver or amplifier, place it on the top shelf so the heated air from it won't flow around other components.

### Position Cables Properly to Avoid Audio Interference

- Insert each cable firmly into the designated jack.
- If you place components above the TV, route all cables down the side of the back of the TV instead of straight down the middle of the back of the TV.
- If your antenna uses 300-ohm twin lead cables, do not coil the cables. Also, keep the twin lead cables away from audio/video cables.

### Important Stand and Base Safety Information







Choose the location for your TV carefully. Place the TV on a stand or base that is of adequate size and strength to prevent the TV from being accidentally tipped over, pushed off, or pulled off. This could cause personal injury and/or damage the TV.

### Use Indirect Light

Don't place the TV where sunlight or room lighting will be directed toward the screen. Use soft or indirect lighting.

## Choose Your Connection

There are several ways to connect your TV. Please use the following chart to determine which connection is best for you. Proceed to the appropriate page and connect your TV.

Components	Cables Needed	Connection Title	Go to...
 TV	1 Coaxial	TV Only	page 6
  TV      VCR	2 Coaxial Audio/Video	TV + VCR	page 6
   TV      VCR      Satellite	4 Coaxial Audio/Video	TV + VCR + Satellite Receiver	page 7

## Cables Needed to Connect Components to Your TV

You will need the following types of cables for the connections represented in this book.

**Notes:** Audio/Video cables (A/V cables for short) are usually sold as a bundled set, but the connection pictures in this book show each cable separately for better visibility. Use the White and Red cables for audio connections and the Yellow cable for video connections.

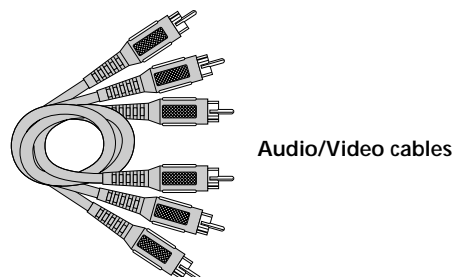
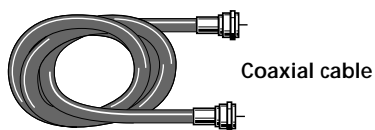

# Connections & Setup

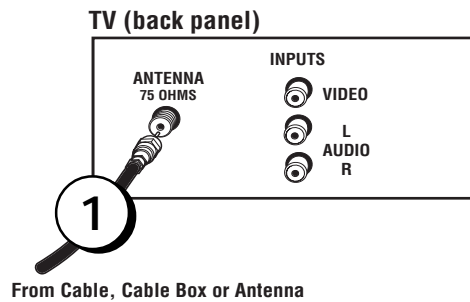
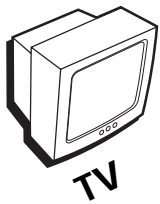

## Connection: TV Only

### 1. Connect the TV to your cable or antenna

Connect the coaxial cable from your cable or antenna to the ANTENNA jack on the back of your TV.

**Go to page 9**

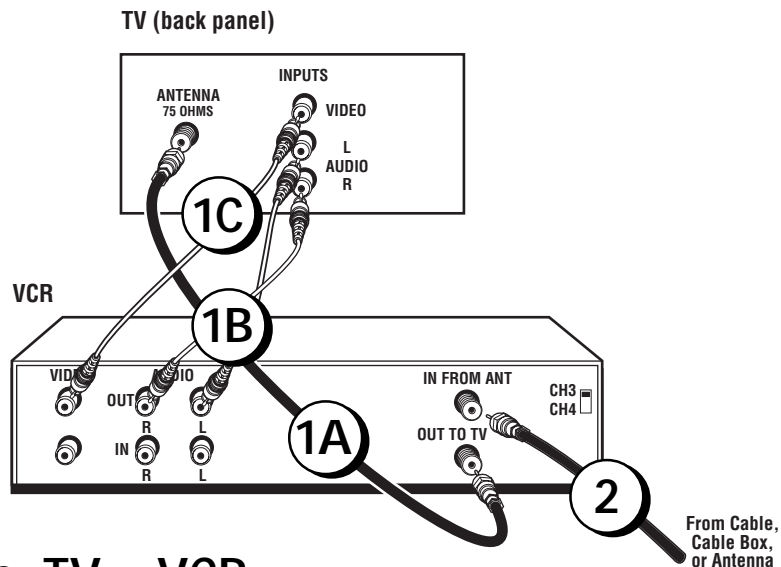
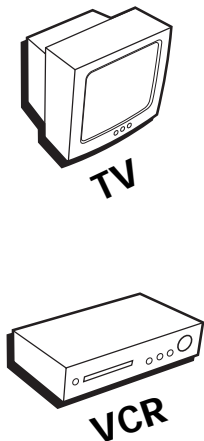

## Connection: TV + VCR

### 1. Connect your TV to your VCR

- Connect a coaxial cable to the ANTENNA jack on your TV and to the Output Jack on your VCR (sometimes labeled OUT TO TV).
- Connect the white and red audio cables to the AUDIO IN jacks on the back of the TV and to the corresponding audio output jacks on the VCR.
- Connect the video cable (yellow) to the VIDEO IN jack on the back of the TV and to the Video Output Jack on the VCR.

### 2. Connect cable or antenna to your VCR

Connect the coaxial cable from your cable outlet, cable box, or antenna to the Input Jack on your VCR (sometimes labeled IN FROM ANTENNA or IN FROM ANT).

**Go to page 9**



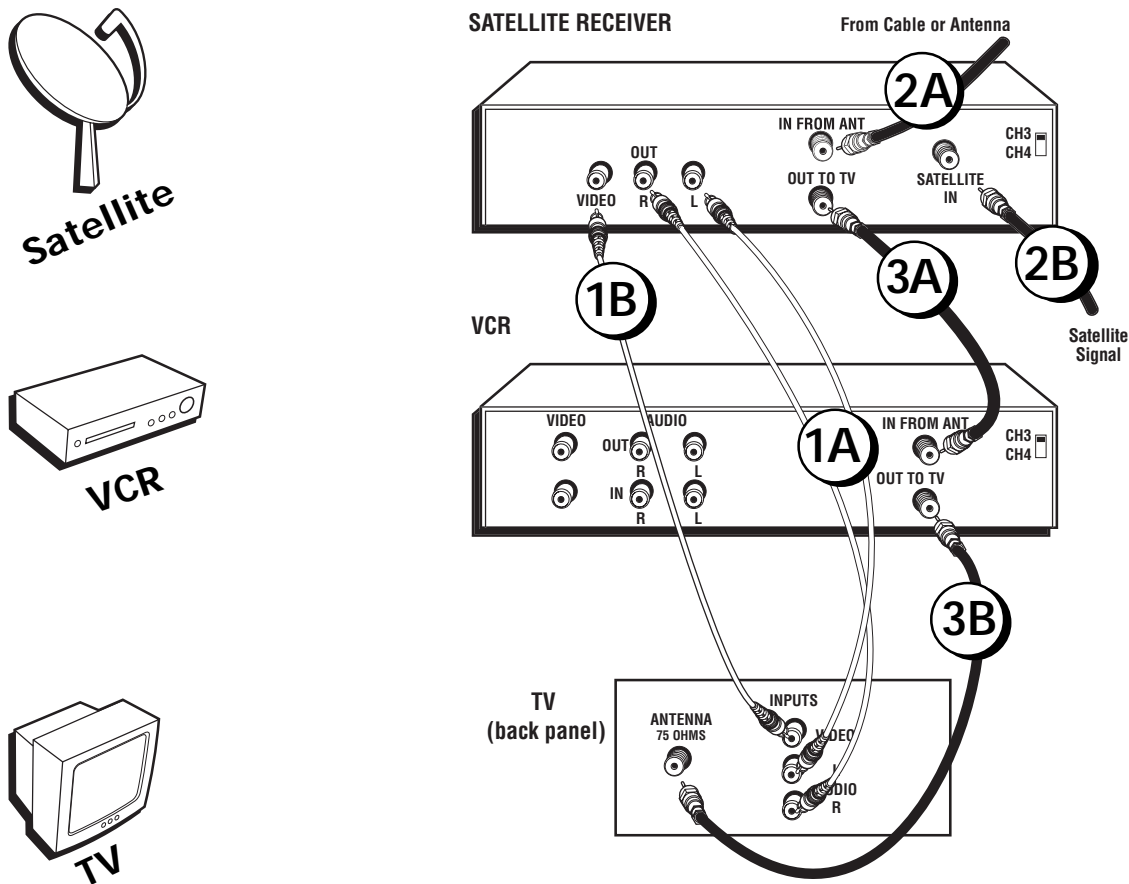

## Connection: TV + VCR + Satellite Receiver

### 1. Connect your Satellite Receiver to your TV

- Connect the white and red audio cables to the AUDIO IN jacks on the back of the TV and to the audio output jacks on the satellite receiver.
- Connect the video cable (yellow) to the VIDEO IN jack on the back of the TV and to the Video Output Jack on the satellite receiver.

### 2. Connect coaxial cables to the Satellite Receiver

- Connect the coaxial cable from your cable outlet, cable box, or antenna to the Input Jack on your satellite receiver (sometimes labeled IN FROM ANT).
- Connect the coaxial cable from your satellite dish antenna to the Input Jack on your satellite receiver (sometimes labeled SATELLITE IN).

### 3. Connect the Satellite Receiver to the VCR and to the TV

- Connect a coaxial cable to the Output Jack (sometimes labeled OUT TO TV) on the satellite receiver and to the Input Jack on the VCR (sometimes labeled IN FROM ANT).
- Connect a coaxial cable to the Output Jack on the VCR (sometimes labeled OUT TO TV) and to the CABLE/ANTENNA jack on the TV.

Go to page 9

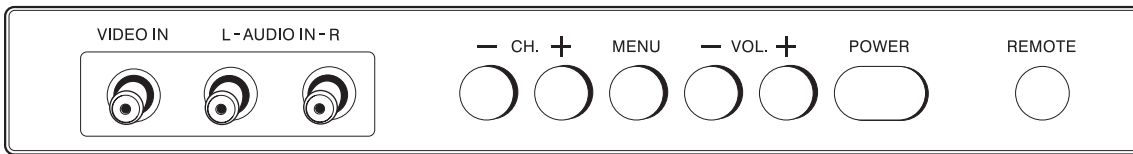

## The Front of Your TV

### Front Panel

If you cannot locate your remote you can use the buttons of your TV to operate many of the TV's features.

**MENU** Brings up the Main menu. When in the menu system, it selects highlighted items. Also returns you to the previous menu.

**CH -** Scans down through the current channel list. When you're using the TV's menu system, it acts like a down arrow.

**CH +** Scans up through the channel list. When you're using the TV's menu system, it acts like an up arrow.

**VOL -** Decreases the volume. When you're using the TV's menu system, it acts like a left arrow.

**VOL +** Increases the volume. When you're using the TV's menu system, it acts like a right arrow.

**POWER** Turns the TV on and off.

### Front Panel Jacks

You can access the component you connected by pressing the INPUT button on your remote to select AV2.

**VIDEO (in)** Allows you to connect a component such as a VCR, camcorder or Internet access device.

**AUDIO L and R (in)** Receives audio signals from another component such as a VCR, camcorder or Internet access device.

## Plug in the TV

Plug the end of the power cord into the wall outlet. Make sure to insert the plug completely into the outlet.

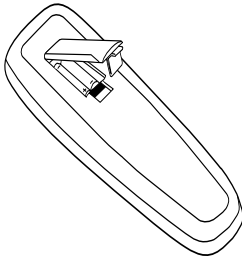

## Put Batteries in the Remote

1. Remove the battery compartment cover on the remote.
2. Insert new batteries. Match the polarities (+ and -) on the batteries with the diagram on the remote.
3. Put the battery compartment cover back on the remote.

## How to Use the Remote Control to Complete Setting Up the TV

The technical term is “Navigation” – how you move through the on-screen menus. The theory is the same throughout the menu screens: highlight your choice and select it.

To highlight a menu item, use the CHAN ^/v buttons to move up or down. Use the VOL +/- buttons to select an item or change its setting.

Press MENU to select an item.

**Note:** *Highlighted means that the menu item stands out from other menu items on the list (appears darker, brighter, or a different color).*

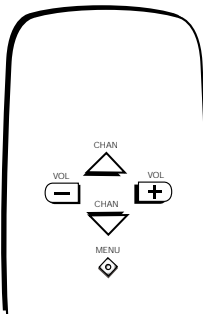

Use the CHAN ^/v and VOL +/- buttons along with the MENU button to move through the menu system.

## Turn on the TV

Press the POWER button on the remote control or on the TV itself.

## Automatic Tuning

The first time you turn on your TV the screen shown on the left appears.

Your TV can search for all channels that are viewable through your antenna or cable-TV system. This is sometimes called “automatic tuning.” Follow the steps below to start automatic tuning.

1. Make sure you have either an off-air antenna or another component connected to the ANTENNA jack on the back of your TV.
2. Press VOL+ begin the automatic tuning.

Your TV automatically cycles through all channel numbers and places the active channels into channel memory. When your TV is finished, it tunes to the lowest channel in its channel memory.

3. Press CHAN ^ or CHAN v to access the channels in the channel list. The channels can also be accessed using the number buttons on the remote.

**Note:** *If you change your location or cable company, you will need to Memorize Channels again.*

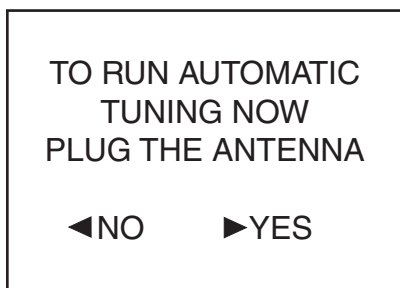

## The Buttons on the Remote Control

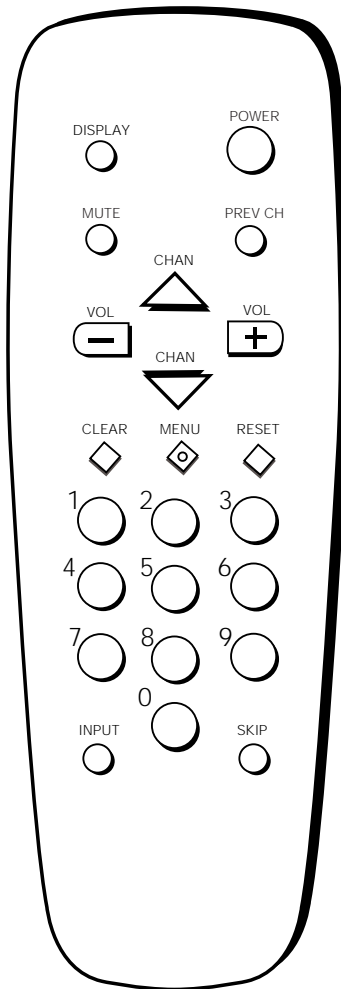

**DISPLAY** Brings up available channel information.

**POWER** Turns the TV on and off.

**MUTE** Turns off the TV's sound. Press again to restore the sound.

**PREV CH** Returns you to the previous channel.

**VOL - or VOL +** Decreases or increases the TV's volume. Also used as left and right arrows in the menu system.

**CHAN ^ or CHAN v** Scans up or down through the current channel list. Press once to change channels; press and hold to continue changing channels. Also used as up and down arrows in the menu system.

**CLEAR** Removes any menu or display from the screen and returns you to TV viewing. Also cancels the SKIP timer.

**MENU** Brings up the Main menu. When in the menu system, selects highlighted items or returns you to the previous menu.

**RESET** Returns all picture quality controls to their original settings.

**(0-9) Number Buttons** Enters channel numbers and time settings directly through the remote control. To enter a three-digit channel, press and hold the first digit, then add the second two.

**INPUT** Press to toggle through available input sources (AV1, AV2, etc.).

**SKIP (Commercial Skip)** Press once before changing channels. The TV will wait 30 seconds before returning you to the original channel. Press again to add more time. Press CLEAR to cancel the SKIP timer.

# Menus and Features

### Chapter Overview:

- Point and Select Method
- Main Menu
- Picture Menu
- Sound Menu
- Channel Menu
- Tuning Menu
- Setup Menu
- Channel Marker

**NOTE:** Illustrations are for representation only. Your product and on-screen displays might differ.

**Changing Entertainment. Again.**



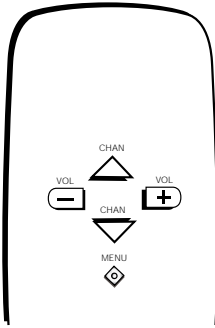

Use the CHAN ^/v and VOL + buttons to move through the menu system.

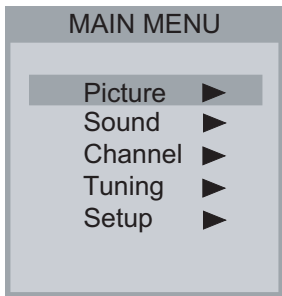

### Tip

Feel free to explore the menu system. If you're ever unsure where you are in the menu system, or you're just plain tired of exploring, press CLEAR to remove the menus from the screen and start over again.

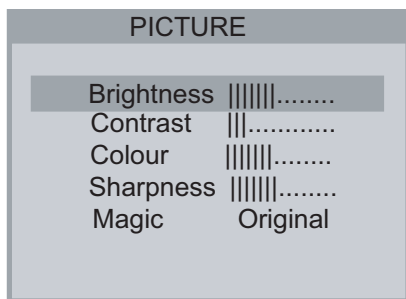

## The Point and Select Method

You only need to know one rule to use the on-screen menus and control panels: point and select.

1. Point to a menu item using the CHAN ^/v buttons to move up or down.
2. Select a menu item by pressing the VOL+ button.

Selecting an item tells the TV's menu system to go ahead and make the change or go to a place you have indicated.

## TV Main Menu

The Main menu is your gateway to controlling the TV. It lets you adjust the TV's picture, sound and channel settings, as well as setup the TV to your match your preferences.

To select a menu item:

1. Press MENU to bring up the TV's Main menu.
2. Point to a menu item using the CHAN buttons on the remote. Select that item by pressing VOL+ on the remote.
3. To exit any menu screen, press MENU *twice*, or press CLEAR *once*.

## The Picture Menu

The Picture Quality menu contains five slider controls that adjust the TV's picture. Use the CH ^/v to select an item, and use the VOL +/- adjust the controls.

**Brightness** Adjusts the brightness of the picture.

**Contrast** Adjusts the difference between light and dark areas of the picture.

**Colour** Adjusts the richness of the color.

**Sharpness** Adjusts the crispness of edges in the picture.

**Magic** Toggles between four preset picture settings:

**Personal** Sets the picture quality to the settings you've defined.

**Original** Returns the picture settings to their factory presets.

- **Brightness** Sets the picture to a darker overall level.

+ **Brightness** Sets the picture to a brighter overall level.

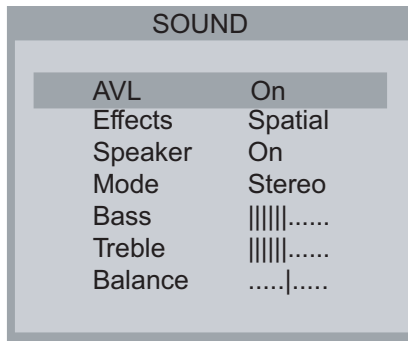

## Sound Menu

**AVL (Auto volume)** Reduces the annoying blasts in volume during commercial breaks, and also amplifies softer sounds in program material. Eliminates the need to constantly adjust volume control.

**Effects** Use the VOL + and – buttons to toggle through the following sound settings:

**Surround** Electronically expands a stereo signal to create a more “involving” sound.

**Stereo** Splits the incoming stereo audio signal into left and right channels. Most TV programs and recorded materials have stereo audio.

**Spatial** Electronically “widens” sound from stereo broadcasts, stereo VCRs, digital satellite systems, DVD players, and LaserDisc players for a fuller, more spacious sound.

**Speaker** Use the VOL + and – buttons to toggle between *On* (which turns on your TV’s internal speakers) and *Off* (which turns off your TV’s internal speakers).

**Mode** Use the VOL + and – buttons to toggle between the following options:

**Mono** Plays the sound in mono only. Use this setting when receiving broadcasts with weak stereo signals.

**Stereo** Splits the incoming stereo audio signal into left and right channels. Most TV programs and recorded materials have stereo audio.

**SAP (Secondary Audio Program)** Plays the program’s audio in a second language, if one is available. SAP audio is broadcast in mono. SAP is also used to broadcast a program’s audio with descriptions of the video for the visually impaired.

**Bass** Use the VOL + and – buttons to adjust the TV’s bass.

**Treble** Use the VOL + and – buttons to adjust the TV’s treble.

**Balance** Use the VOL + and – buttons to adjust the TV’s balance.

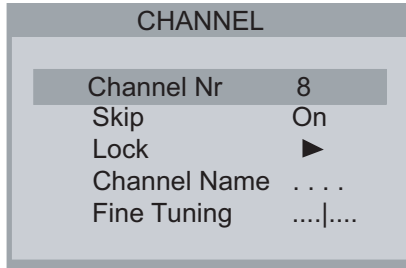

## Channel Menu

**Channel Nr** Use the VOL + and – buttons to scroll up and down through the channels available via your antenna. You can enter the channel number directly using the number buttons.

**Skip** Use the VOL + and – buttons to indicate whether you want to skip the channel number indicated when you scan through the channels.

**On** Skips the selected channel.

**Off** Includes the selected channel in your channel list.

**Lock** Use the VOL+ button to access the following items in the Lock menu:

**Password** To access the lock menu, use the number buttons on the remote to enter your password. The first time you use this feature, enter the default password, “7685.” After that you can use either your own password once you’ve set it, or the factory password.

**Channel Nr** Use the VOL + and – buttons to scroll up and down through the channels available via your antenna. You can enter the channel number directly using the number buttons.

**Lock** Use the VOL + and – buttons to toggle between ON and OFF.

**On** Locks the channel selected.

**Off** Leaves the current channel unlocked.

**New Password** Use the number buttons on your remote to set a new password.

**Panel Lock** Locks and unlocks the front panel. Use the VOL + and – buttons to turn the front panel lock on and off. When the front panel is locked you must use the remote to control the TV.

**Channel Name** Press the VOL + to name the current channel. Use the CHAN ^/v buttons to enter a four-character label for the channel. Press VOL + to go to the next character. Press VOL – to go back to the previous character. Once you’ve entered all four characters, press VOL + to confirm the name. The TV can store up to 40 labels in memory.

**Fine Tuning** Use VOL + and VOL – to adjust the fine tuning of the selected channel.

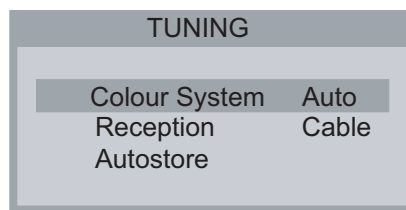
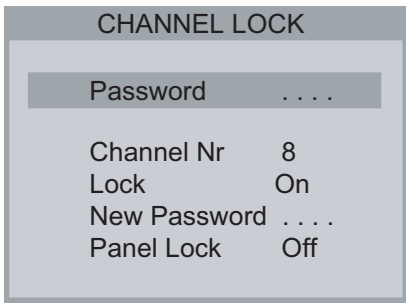

## Tuning Menu

**Colour System** Use the VOL + or VOL – buttons to select the broadcast standard used in your area.

**Auto** Automatically detects the broadcast standard used in your area.

**PAL-N** Sets your TV to receive broadcasts in the PAL-N standard.

**PAL-M** Sets your TV to receive broadcasts in the PAL-M standard.

**NTSC** Sets your TV to receive broadcasts in the NTSC standard.



**Reception** Use the VOL + or VOL - buttons to select the type of input signal you connected to the antenna jack on the back of your TV.

**Auto** Automatically detects the type of input signal you're using (cable or antenna).

**Antenna** Choose this option if you have an off-air antenna connected to the antenna jack on the back of your TV.

**Cable** Choose this option if you have a cable feed connected to the antenna jack on the back of your TV.

**Autostore** Press VOL + to start the Autostore channel search, which places all active channels into memory.

SETUP	
Closed Caption	CC1
Language	English
Screen Saver	On
Demo	
Clock	16:29
. On Screen	On
Alarm	Off
. Time	00:00
. Channel	5

## Setup Menu

**Closed Caption** Lets you choose which captioning mode is used for displaying captioning information. Use VOL + and VOL - to select from the following nine choices:

**Off** No closed captioning is displayed.

**CC1** Displays the primary captioning information in the primary language.

**CC2, CC3, CC4** Displays the secondary captioning information.

**Text 1-4** Displays captioning information in text mode.

**Note:** The Text modes cover nearly half of the picture on the screen to display the closed-captioned text. Most broadcasters use the CC mode, which displays a few lines of captions at a time.

**Language** Use VOL + and VOL - to select your preferred language for the menus: *English* or *Spanish*.

**Screen Saver** Your TV has a built-in screen saver that appears when there is no signal present in order to prolong the life of your TV. Use VOL + and VOL - to toggle between *On* and *Off*.

**Demo** Starts a demonstration of the TV's main features. Press VOL + to start the demonstration.

**Clock** Lets you set the clock. Use the number buttons on the remote to enter the current time.

**On Screen** Displays the time in the channel banner everytime you change channels. Use VOL + and VOL - to toggle between *On* and *Off*.

**Alarm** Turns the TV on automatically at a set time on a set channel. Use the VOL+ and VOL - buttons to toggle between *On* and *Off*.

**Time** Use the number buttons on the remote to enter the time you want the TV to turn on automatically.

**Channel** Use the number buttons or VOL + and VOL - to select the channel to which you want the TV to tune when it turns on automatically.

**Note:** The TV turns off automatically if it remains inactive for five minutes immediately after being turned on by the alarm.

---

## Tip

If you don't know which Closed-Caption mode to use, select *CC1*. *CC1* is probably the mode that is used in your area. *CC2*, *CC3*, and *CC4* are reserved for foreign languages, but are rarely used at this time.

---

## Using Closed Captioning

Many programs are encoded with closed-captioning information, which lets you display the audio portion of a program as text on the TV screen.

Closed captioning is not available on all channels at all times. Only specific programs encoded with closed-captioning information are applicable.

### Turning off Closed-Caption

1. Select *Setup* from the Main menu. *Closed Caption* is highlighted in the *Setup* menu.
2. Use the VOL + or VOL - to cycle through the choices until you reach *Off*.
3. Press MENU twice (or CLEAR once) to exit the menu system.

## Channel Marker

The Channel Marker comes up when you first turn on the TV, change channels, or press the DISPLAY button.

**08:59** Displays the current time.

**WRTV** Displays the label assigned to the current channel.

**06** Displays the current channel.

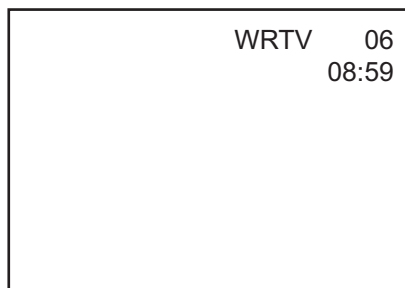

# Other Information

### Chapter Overview:

- Troubleshooting
- Care and Cleaning
- Index

**Changing Entertainment. Again.**



## Troubleshooting

Most problems you encounter with your TV you can correct by consulting the Troubleshooting list that follows.

### ***TV Problems***

---

#### **TV won't turn on**

- Press the POWER button.
- Make sure the TV is plugged in.
- Check the wall receptacle (or extension cord) to make sure it is "live" by plugging in something else.
- Something might be wrong with your remote control. Press the POWER button on the front of the TV. If the TV turns on, check the remote control solutions on the next page.
- Make sure the remote is pointed directly at the remote sensor on the TV's front panel.
- The front panel buttons may be locked (disabled). Use the remote control to unlock the front panel controls by selecting *Lock* in the *Channel* menu, then selecting *Panel Lock* and choosing *OFF*.

#### **Front panel buttons don't work**

- The front panel buttons may be locked (disabled). Use the remote control to unlock the front panel controls by selecting *Lock* in the *Channel* menu, then selecting *Panel Lock* and choosing *OFF*.
- Unplug the TV for 15 minutes and then plug it back in. Turn the TV on and try again.

#### **TV turns off while playing**

- If the TV remains inactive for five minutes after being turned on by the Alarm function, it will automatically turn off.
- Electronic protection circuit may have been activated because of a power surge. Wait 30 seconds and then turn the TV on again. If this happens frequently, the voltage in your house may be abnormally high or low.

#### **TV turns on unexpectedly**

- The Alarm function may have been activated. Go to p. 15 for instructions.

#### **Blank screen**

- Make sure the component connected to the TV is turned on.
- Try another channel.

#### **No sound, picture okay**

- Maybe sound is muted. Press the volume up button to restore sound.

#### **Can't select certain channel**

- Channel may be locked out in the *Channel Lock* menu.
- Channel may not be in the channel memory. Try using the number buttons on the remote.
- If using a VCR, make sure the TV/VCR button on the VCR is in the correct mode (press the TV/VCR button on your VCR).

## Troubleshooting

### No picture, no sound but TV is on

- Maybe the cable/antenna setting is set to the wrong position. Select *Tuning* from the Main menu, highlight the *Reception* option, and use the VOL + and VOL - buttons to choose the correct signal type. Go to pages 16 for detailed instructions.
- The channel might be inactive — change channels.
- If you're watching your VCR and it's connected with coaxial cable to the ANTENNA jack, tune the TV to channel 3 or 4 (whichever channel is selected on the 3/4 switch on the back of your VCR). Also check to make sure the TV/VCR button on the VCR is in the correct mode (press the TV/VCR button on your VCR).

### Sound okay, picture poor

- Check antenna connections. Make sure all of the cables are firmly connected to the jacks.
- Try adjusting sharpness function to improve weak signals. Go to page 21 for more instructions.

### Black box appears on the screen

- Closed-captioning might be on. Check the *Closed-Caption* item in the *Setup* menu. Go to page 16 for more instructions.

### Color distorted in one or more areas of the screen

- Try unplugging the set for at least 15 minutes. Plug the set back in (make sure to insert the plug firmly into the socket) and press POWER on the remote or on the TV itself. For best results, position the TV before you plug it back in.

## *The Remote Control Doesn't Work*

---

- Something might be between the remote and the remote sensor on the component. Make sure there is a clear path.
- Maybe the remote isn't aimed directly at the TV.
- Maybe batteries in remote are weak, dead or installed incorrectly. Put new batteries in the remote.
- You might need to drain the remote's microprocessor: remove batteries and press the number 1 button for at least 60 seconds. Release the 1 button, replace the batteries, and (if necessary) program the remote again.

## Care and Cleaning

**CAUTION: Turn OFF your TV before cleaning.**

You can clean the TV as required, using a soft lint-free cloth. Be sure to occasionally dust the ventilation slots in the cabinet to help assure adequate ventilation.

**The TV's screen may be cleaned with a soft, lint-free cloth as well. Take care not to scratch or mar the screen. If necessary, you may use a cloth dampened with warm water.**

**Never use strong cleaning agents, such as ammonia-based cleaners, or abrasive powder. These types of cleaners will damage the TV.**

While cleaning do not spray liquid directly on the screen, or allow liquid to run down the screen and inside the TV. Also, avoid placing drinks or vases with water on top of the TV. This could increase the risk of fire or shock hazard or damage to the TV.

**Caution:** If fixed (non-moving) images are left on the screen for long periods, they may be permanently imprinted on the picture tube. Such images include network logos, phone numbers, and video games. This damage is not covered by your warranty. Extended viewing of channels displaying these images should be avoided.

## Index

- A**
  - Advanced connections 7
  - Audio
    - menu 14
- B**
  - Basic
    - connections 6
  - Batteries for the remote 9
- C**
  - CABLE/ANTENNA jack 6, 7
  - Cables
    - audio/video 5
    - coaxial 5
  - CHAN 10
  - Channel indicator 16
  - Channel list 9, 10
  - Channel numbers 10
  - CLEAR 10
  - Coaxial cable 5
  - Connections
    - multiple 7
    - TV + VCR 6
    - TV only 6
  - Current channel list 10
- E**
  - Entering channel numbers 10
- F**
  - Fixed images 20
  - Front panel
    - buttons 8
    - jacks 8
- I**
  - INPUT 10
  - Input sources 10
- L**
  - Labels 16
- M**
  - Main menu 10
  - Memory 14
  - MENU 10
  - MUTE 10
- N**
  - Number buttons 10
- P**
  - Point and select 12
  - PREV CH button 10
  - Previous channel 10
- R**
  - Remote, batteries 9
  - Remote buttons 10
  - RESET 10
- S**
  - Satellite receiver, connecting 7
- T**
  - Time display 16
  - Troubleshooting 18
  - TV, connecting 6
- V**
  - VCR, connecting 6
  - VIDEO IN jack 6, 7

Please do not send any products to the Indianapolis address listed in this manual or on the carton. This will only add delays in service for your product.

**Thomson multimedia Inc.**

10330 North Meridian Street  
Indianapolis, IN 46290

©2001 Thomson multimedia Inc.  
Trademark(s)® Registered  
Marca(s) Registrada(s)  
Printed in Manaus, Brazil  
TOCOM 15775710



## Free Manuals Download Website

<http://myh66.com>

<http://usermanuals.us>

<http://www.somanuals.com>

<http://www.4manuals.cc>

<http://www.manual-lib.com>

<http://www.404manual.com>

<http://www.luxmanual.com>

<http://aubethermostatmanual.com>

Golf course search by state

<http://golfingnear.com>

Email search by domain

<http://emailbydomain.com>

Auto manuals search

<http://auto.somanuals.com>

TV manuals search

<http://tv.somanuals.com>