

# RCA

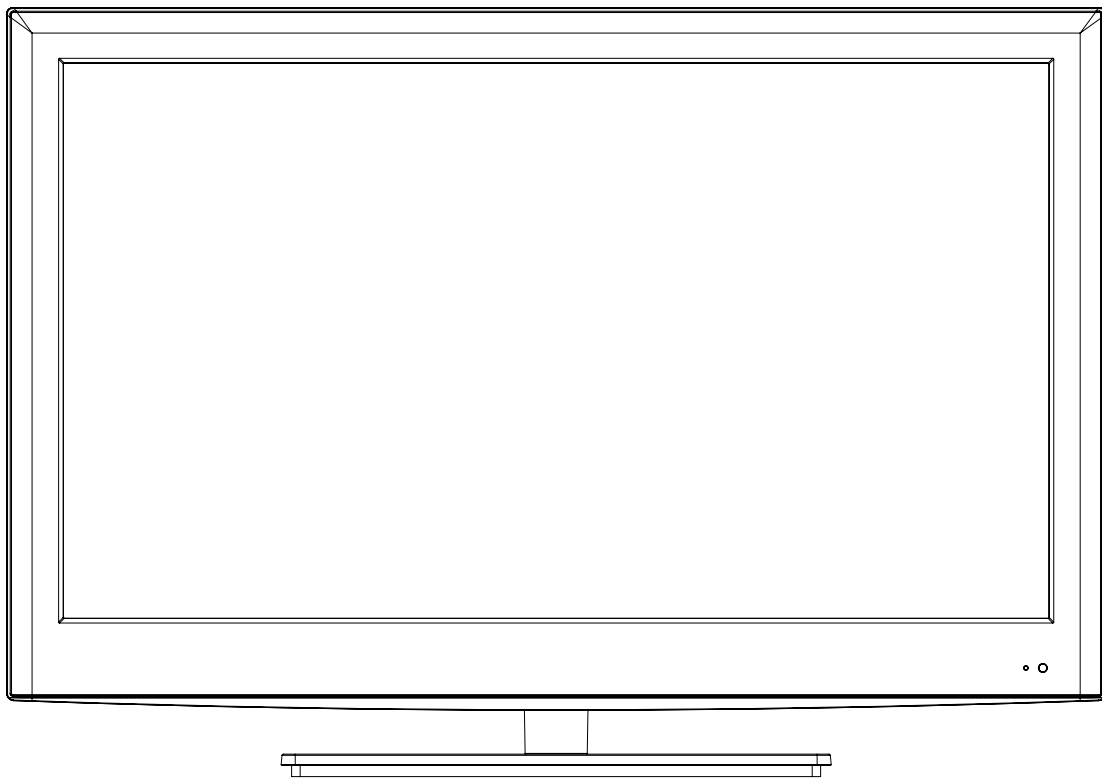

## User Manual

Model: J22DE220

**Before connecting, operating or adjusting this product, please read the manual completely. Please keep this manual for future reference.**

# Table of Contents

---

<b>Important Safety Instructions</b> .....	<b>1</b>
<b>Important Notice</b> .....	<b>4</b>
<b>Preparations</b> .....	<b>5</b>
<b>Identification of Controls</b> .....	<b>7</b>
<b>Connections</b> .....	<b>10</b>
<b>Basic Operations</b> .....	<b>13</b>
<b>Getting Started</b> .....	<b>14</b>
<b>USB (Multimedia) Menu</b> .....	<b>22</b>
<b>Troubleshooting</b> .....	<b>24</b>
<b>Specifications</b> .....	<b>25</b>
<b>Wall mounting operation</b> .....	<b>26</b>

# Important Safety Instructions

Electrical energy can perform many useful functions, but it can also cause personal injuries and property damage if improperly handled. This product has been engineered and manufactured with the highest priority on safety. But **IMPROPER USE CAN RESULT IN POTENTIAL ELECTRICAL SHOCK OR FIRE HAZARD**. In order to prevent potential danger, please observe the following instructions when installing, operating and cleaning the product. To ensure your safety and prolong the service life of your TV product, please read the following precautions carefully before using the product.

**1. Read these instructions**---All operating instructions must be read and understood before the product is operated.

**2. Keep these instructions**---These safety and operating instructions must be kept in a safe place for future reference.

**3. Heed all warnings**---All warnings on the product and in the instructions must be observed closely.

**4. Follow all instructions**---All operating instructions must be followed.

**5. Do not use this apparatus near water**---for example, near a bathtub, washbowl, kitchen sink, or laundry tub, in a wet basement, or near a swimming pool, and the like.

Do not use immediately after moving from a low temperature to high temperature environment, as this causes condensation, which may result in fire, electric shock, or other hazards.

The apparatus shall not be exposed to dripping or splashing and that no objects filled with liquids, such as vases, shall be placed on the apparatus.

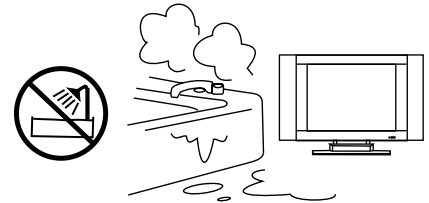

**6. Clean only with dry cloth**---Unplug this product from the wall outlet before cleaning. Do not use liquid cleaners or aerosol cleaners. Use a damp cloth for cleaning.

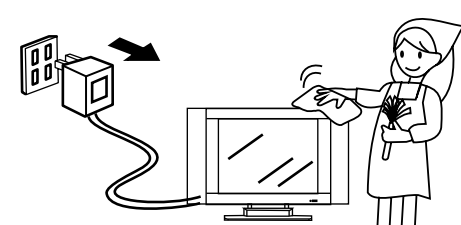

**7. Ventilation**---Do not block any ventilation openings. Install in accordance with the manufacturer instructions. The vents and other openings in the cabinet are designed for ventilation. Do not cover or block these vents and openings since insufficient ventilation can cause overheating and/or shorten the life of the product. Do not place the product on a bed, sofa, rug or other similar surface, since they can block ventilation openings. This product is not designed for built-in installation; do not place the product in an enclosed place such as a bookcase or rack, unless proper ventilation is provided or the manufacturer's instructions are followed.

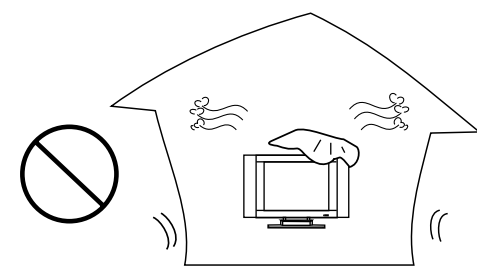

**8. Heat sources**---Do not install near any heat sources such as radiators, heat registers, stoves, or other apparatus (including amplifiers) that produce heat.

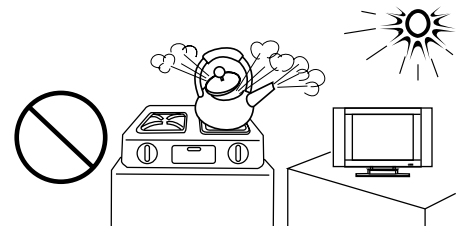

**9. Grounding or Polarization**---Do not defeat the safety purpose of the polarized or grounding-type plug. A polarized plug has two blades with one wider than the other. A grounding type plug has two blades and a third grounding prong. The wide blade or the third prong are provided for your safety. If the provided plug does not fit into your outlet, consult an electrician for replacement of the obsolete outlet.

**10. Power cord protection**---Protect the power cord from being walked on or pinched particularly at plugs, convenience receptacles, and the point where they exit from the apparatus.

**NOTE:** where the mains plug or an appliance coupler is used as the disconnect device, the disconnect device shall remain readily operable.

**11. Attachments**---Only use attachments/accessories specified by the manufacturer. Do not use attachments not recommended by the manufacturer. Use of improper attachments can result in accidents.

# Important Safety Instructions (Continued)

**12. Stand**---Use only with the cart, stand, tripod, bracket, or table specified by the manufacturer, or sold with the apparatus. Do not place the product on an unstable trolley, stand, tripod or table. Placing the product on an unstable base can cause the product to fall, resulting in serious personal injuries as well as damage to the product. When mounting the product on a wall, be sure to follow the manufacturer's instructions. Use only the mounting hardware recommended by the manufacturer.

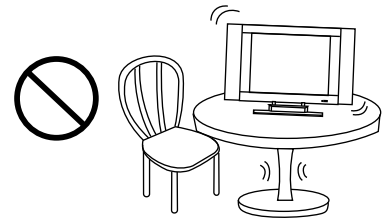

**13. Move carefully**---When a cart is used, use caution when moving the cart/apparatus combination to avoid injury from tip-over. Sudden stops, excessive force and uneven floor surfaces can cause the product to fall from the trolley. Never attempt to move the TV unless the AC power cord has been disconnected.



**14. Lightning**---Unplug this apparatus during lightning storms or when unused for long periods of time. For added protection for this television equipment during a lightning storm, or when it is left unattended and unused for long periods of time, unplug it from the wall outlet and disconnect the antenna. This will prevent damage to the equipment due to lightning and power-line surges.

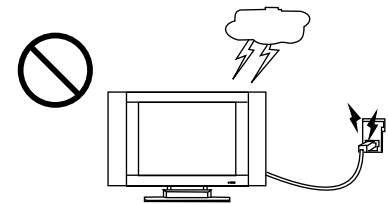

**15. Servicing**---Refer all servicing to qualified service personnel. Servicing is required when the apparatus has been damaged in any way, such as power-supply cord or plug is damaged, liquid has been spilled or objects have fallen into the apparatus, the apparatus has been exposed to rain or moisture, does not operate normally, or has been dropped.

**16. Replacement parts**---In case the product needs replacement parts, make sure that the service person uses replacement parts specified by the manufacturer, or those with the same characteristics and performance as the original parts. Use of unauthorized parts can result in fire, electric shock and/or other danger.

**17. Overloading**---Do not overload wall outlets, extension cords, or convenience receptacles on other equipment as this can result in a risk of fire or electric shock.

**18. Entering of objects and liquids**---Never insert an object into the product through vents or openings. High voltage flows in the product, and inserting an object can cause electric shock and/or short internal parts. For the same reason, do not spill water or liquid on the product.

**19. Damage requiring service**---If any of the following conditions occurs, unplug the power cord from the AC outlet, and request a qualified service person to perform repairs.

- a. When the power cord or plug is damaged.
- b. When a liquid is spilled on the product or when objects have fallen into the product.
- c. When the product has been exposed to rain or water.
- d. When the product does not operate properly as described in the operating instructions.

Do not touch the controls other than those described in the operating instructions. Improper adjustment of controls not described in the instructions can cause damage, which often requires extensive adjustment work by a qualified technician.

- e. If the product has been dropped or the cabinet has been damaged in any way.
- f. When the product displays an abnormal condition or exhibits a distinct change in performance. Any noticeable abnormality in the product indicates that the product needs servicing.

**20. Safety checks**---Upon completion of service or repair work, request the service technician to perform safety checks to ensure that the product is in proper operating condition.

**21. Wall or ceiling mounting**---When mounting the product on a wall or ceiling, be sure to install the product according to the method recommended by the manufacturer. This is a safety feature.

## Important Safety Instructions (Continued)

**22. Power source**---This product is intended to be supplied by a listed power supply indicated on the marking label. If you are not sure of the type of power supply to your home, consult your product dealer or local power company. For added protection for this product during a lightning storm, or when it is left unattended and unused for long periods of time, unplug it from the wall outlet and disconnect the cable system. This will prevent damage to the product due to lightning and power line surges. When the unit has to be used with another power supply voltage, the power cable must be changed. Consult your product dealer. The socket outlet should be installed near the equipment and easily accessible. Use only the power cord designated by our dealer to ensure safety and EMC. When connecting other products such as VCRs and personal computers, you should turn off the power of the unit for protection against electric shock.

**23. Panel protection**---The display panel used in this product is made of glass. Therefore, it can break when the product is dropped or impacted upon by other objects. Be careful not to be injured by broken glass pieces in case the display panel breaks.

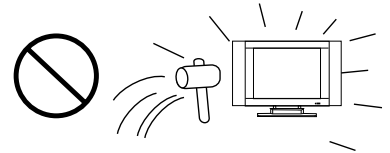

**24. Pixel defect**---The display panel is a very high technology product, giving you finely detailed pictures. Occasionally, a few non-active pixels may appear on the screen as a fixed point of blue, green or red. Please note that this does not affect the performance of your product.

**WARNING:** For continued safety, apparatus with class I construction shall be connected to a mains socket outlet with a protective earthing connection.

# Important Notice

---

---

## About Temperature

### Do not use in hot and cold rooms (locations)

- When the unit is used in rooms (locations) with low temperature, the picture may leave trails or appear slightly delayed. This is not a malfunction, and the unit will recover when the temperature returns to normal.
- Do not leave the unit in a hot or cold location. Also, do not leave the unit in a location exposed to direct sunlight or near a heater, as this may cause the cabinet to deform and the to malfunction.
- Storage temperature: 32°F to +122°F
- Working temperature: 41°F to +104°F

---

## About After-Image

The extended use of fixed image program material can cause a permanent after-image on the screen.

This background image is viewable on normal programs in the form of a stationary fixed image. This type of irreversible screen deterioration can be limited by observing the following steps:

- A. Reduce the brightness/contrast setting to a minimum viewing level.
- B. Do not display the fixed image for extended periods of time.
- C. Turn the power off when not in actual use.

### Important Information Regarding Use of Video Games, Computers, Captions or Other Fixed Image Displays.

- Do not allow a still picture to be displayed for an extended period, as this can cause a permanent after-image to remain on the screen.

Examples of still pictures include logos, video games, computer images, teletext and images displayed in 4:3 mode.

### CAUTIONS:

- The permanent after-image on the screen resulting from fixed image use is not an operating defect and as such is not covered by the warranty.
- This product is not designed to display fixed images for extended periods of time.

**Do not let images display in 4:3 mode for extended periods of time.**

---

## Cleaning and Maintenance

### To clean this unit, wipe with a soft, dry cloth.

If the surfaces are extremely dirty, use a soft cloth dipped in a soap and water solution or a weak detergent solution.

- Use eyeglass cleaner to remove stubborn dirt from the screen.
- Never use alcohol, paint thinner or benzine to clean this unit.
- Before using a chemically treated cloth, read the instructions that came with the cloth carefully.

# Preparations

## Using the Remote Control

- Use the remote control by pointing it towards the remote sensor window of the set. Objects between the remote control and sensor window may prevent proper operation.

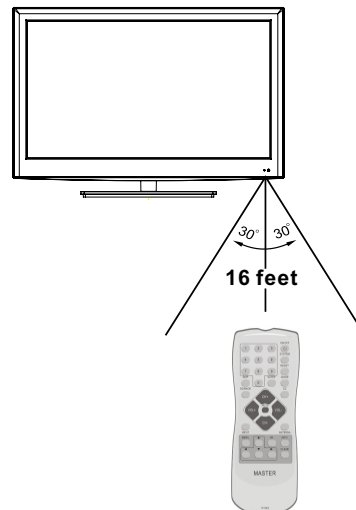

### Cautions regarding use of remote control

- Do not expose the remote control to shock. In addition, do not expose the remote control to liquids, and do not place in an area with high humidity.
- Do not install or place the remote control under direct sunlight. The heat may cause deformation of the unit.
- The remote control may not work properly if the remote sensor window of the main unit is under direct sunlight or strong lighting. In such a case, change the angle of the lighting or the TV set, or operate the remote control closer to the remote sensor window.

## Installing the Batteries

If the remote control fails to operate the TV functions, replace the batteries in the remote control.

- 1 Open the battery cover.
- 2 Insert two size AA batteries.
  - (Place the batteries with their terminals corresponding to the (+) and (-) indications in the battery compartment.)
- 3 Replace the cover.

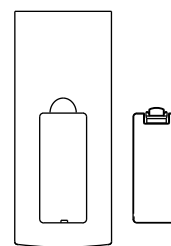

### Precaution on battery use

- Dispose of batteries in a designated disposal area.
- Batteries should always be disposed of with the environment in mind. Always recycle or dispose of batteries in accordance with applicable laws and regulations.
- Improper use of batteries can result in a leakage of chemicals and/or explosion. Be sure to follow the instructions below.
  1. Place batteries with their terminals corresponding to the (+) and (-) indications.
  2. Different types of batteries have different characteristics. Do not mix batteries of different types.
  3. Do not mix old and new batteries. Mixing old and new batteries can shorten the life of new batteries and/or cause old batteries to leak chemicals.
  4. Remove batteries as soon as they are non-operable. Chemicals that leak from batteries can cause a rash. If chemical leakage is found, wipe with a cloth.
  5. If the remote control is not used for an extended period of time, remove the batteries from the remote control.
  6. The batteries (battery pack of batteries installed) shall not be exposed to excessive heat such as sunshine, fire or the like.

# Preparations (Continued)

## Antenna Connection

INSTALL the unit in a room where direct light will not fall upon the screen. Total darkness or a reflection on the picture screen may cause eyestrain. Soft and indirect lighting is recommended for comfortable viewing.

Optimal picture reception requires good signal and will generally mean that an amplified antenna must be used.

The exact type and position of the antenna will depend upon your particular area.

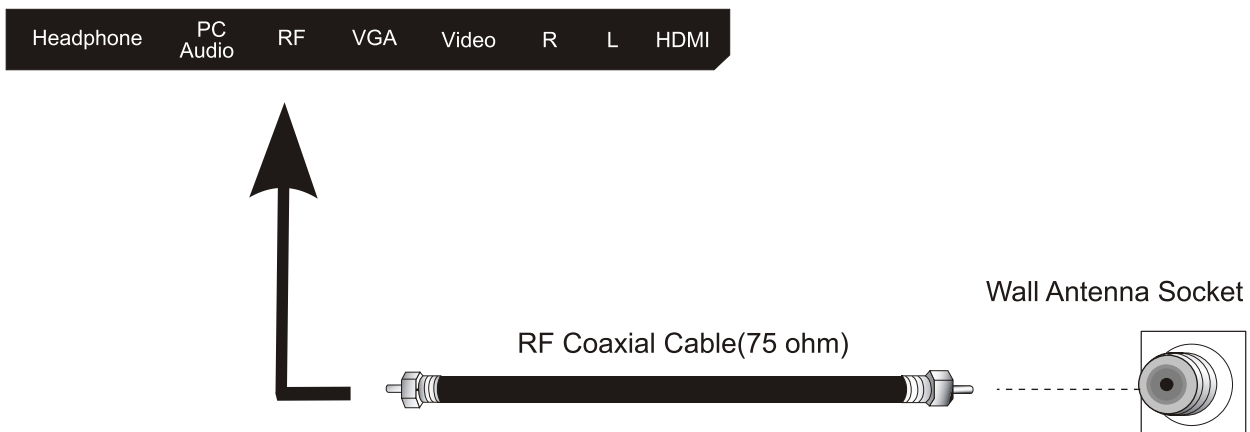

### Note:

- It is recommended that the 75-ohm coaxial cable be used to eliminate interference and noise which may occur due to radio wave conditions.
- The antenna cable should not be bundled with the power cord and the like.
- If the antenna is not installed properly, contact your dealer for assistance.

## Power Connection

Insert the AC plug into a conveniently located AC outlet.

### Note

- This product should be operated only from the type of power source indicated on the marking label.
- Always unplug the AC cord from power outlet when not using for a long period of time.



# Identification of Controls

## Main Unit (control panel)

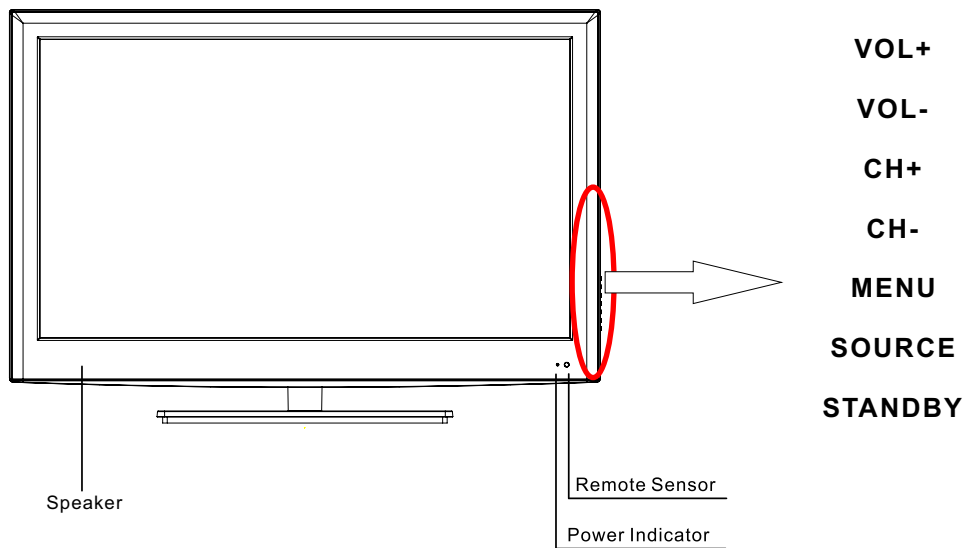

### 1. STANDBY

Press this button to turn the unit ON from STANDBY mode. Press it again to turn the set back to STANDBY.

### 2. SOURCE

To access INPUT SOURCE menu

### 3. MENU

Press this button to access the menu main page.

### 4. CH+/-

Press these two buttons to directly change the TV channel;  
In menu operations, these buttons serve as up/down buttons.

### 5. VOL+/-

Press the **VOL+** or **VOL -** button to directly increase or decrease the sound volume level;  
In menu operations, these buttons serve as right/left buttons.

## NOTE:

*Functions of **CH+/-**, **VOL+/-**, **MENU**, **SOURCE** and **STANDBY** are also provided to the remote control. This operation manual provides a description based on operating functions with the remote control.*

# Identification of Controls (Continued)

## Main Unit (connectors)

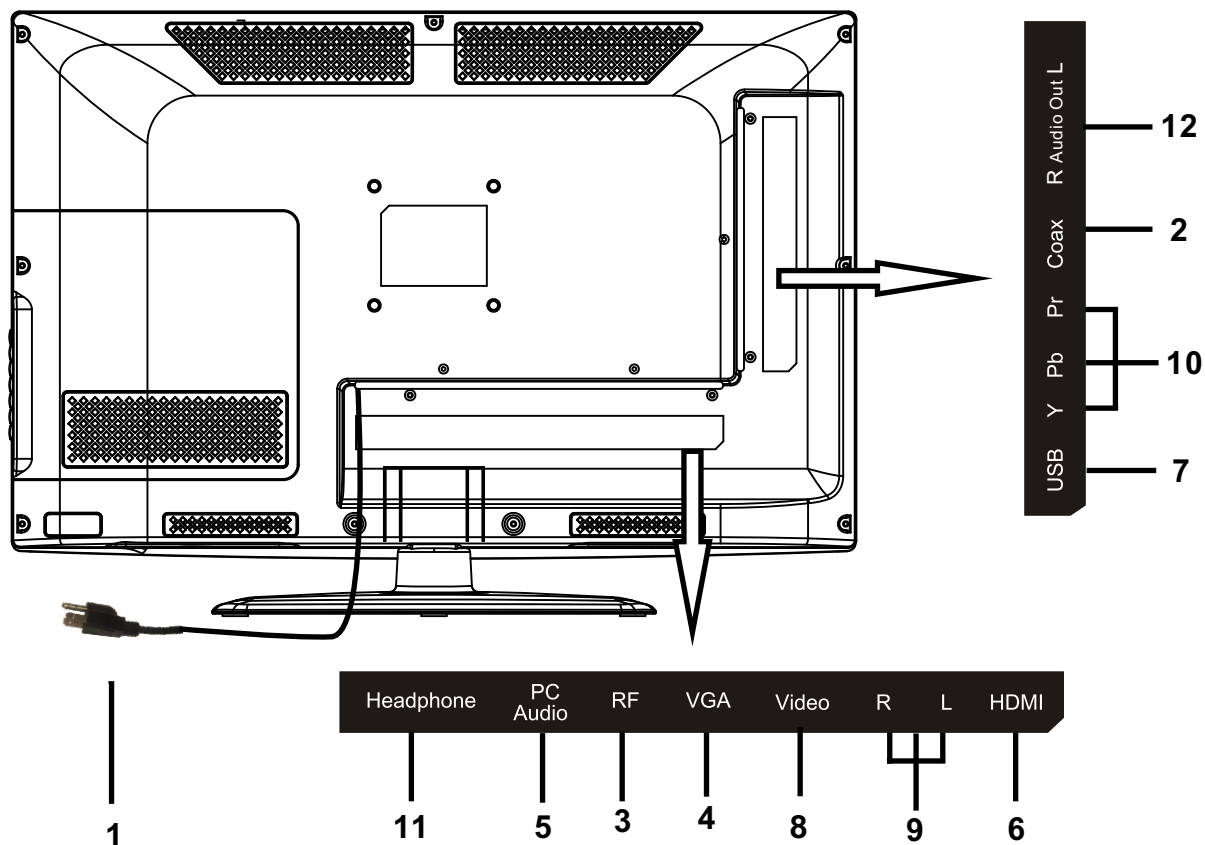

1. **POWER CORD**-Main power input.

2. **COAX**-Connect the SPDIF receiver.

3. **RF**-This connection is for digital or analog cable without the cable box or over-the-airwave antennas. The tuner is a hybrid tuner that tunes to both analog and digital channels. This connection uses coaxial RF cable.

4. **VGA** - This connection port connects to a PC for video using VGA cable. Be sure to connect your audio cable to the VGA Stereo input if you want sound out of VGA video source.

5. **PC Audio** -This connection port is for people who want to provide audio to the TV when using a PC. The sources use 3.5mm mini-jack audio cable.

6. **HDMI**-HDMI connects to devices that use HDMI cable, such as Blu-ray or HD DVD player, or HD cable / satellite set-top box. This connection port receives pure digital audio and high definition signal through one single cable. This port also can accept a HDCP video device for video.

7. **USB**-Connect to portable USB storage device.

8. **Video** -Video connects to devices that use composite video cables such as VCR or DVD player or Wii™. Connect the yellow for video and the red / white for audio. **Please Note: audio is shared with YPbPr port.**

9. **L/R**-These two connections are audio connection for either YPbPr or Video port.

10. **YPbPr**-This connection port is for DVD players or satellite / cable set-top boxes that use component cables. From left to right, connect green, blue, and red for video, and then connect white for left channel audio, and red for right channel audio. **Please Note: audio is shared with Video port.**

11. **Headphone Out.**

12. **R/L Out**-These two connections are audio out.

# Identification of Controls (Continued)

## Remote Control Unit

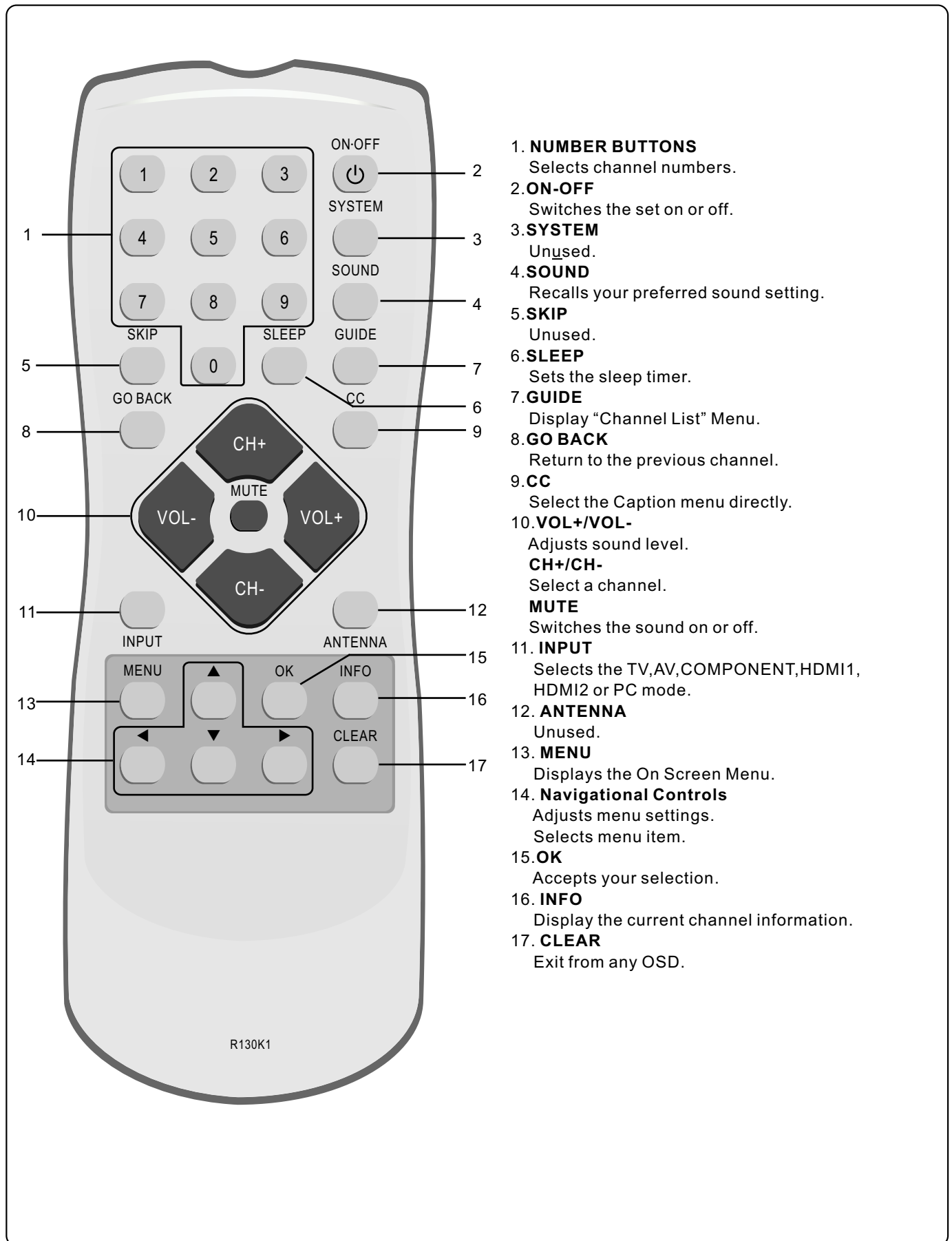

1. **NUMBER BUTTONS**  
Selects channel numbers.
2. **ON-OFF**  
Switches the set on or off.
3. **SYSTEM**  
Unused.
4. **SOUND**  
Recalls your preferred sound setting.
5. **SKIP**  
Unused.
6. **SLEEP**  
Sets the sleep timer.
7. **GUIDE**  
Display "Channel List" Menu.
8. **GO BACK**  
Return to the previous channel.
9. **CC**  
Select the Caption menu directly.
10. **VOL+/VOL-**  
Adjusts sound level.
11. **INPUT**  
Selects the TV, AV, COMPONENT, HDMI1, HDMI2 or PC mode.
12. **ANTENNA**  
Unused.
13. **MENU**  
Displays the On Screen Menu.
14. **Navigational Controls**  
Adjusts menu settings.  
Selects menu item.
15. **OK**  
Accepts your selection.
16. **INFO**  
Display the current channel information.
17. **CLEAR**  
Exit from any OSD.

R130K1

# Connections

## Cautions Before Connecting

- Carefully check the terminals for position and type before making any connections.
- The illustration of the external equipment may be different depending on your model.
- Loose connectors can result in image or colour problems. Make sure that all connectors are securely inserted into their terminals.
- Refer to the operating manual of the external device as well.
- When connecting an external device, turn the power off to avoid any issues.

## Connecting a VCR

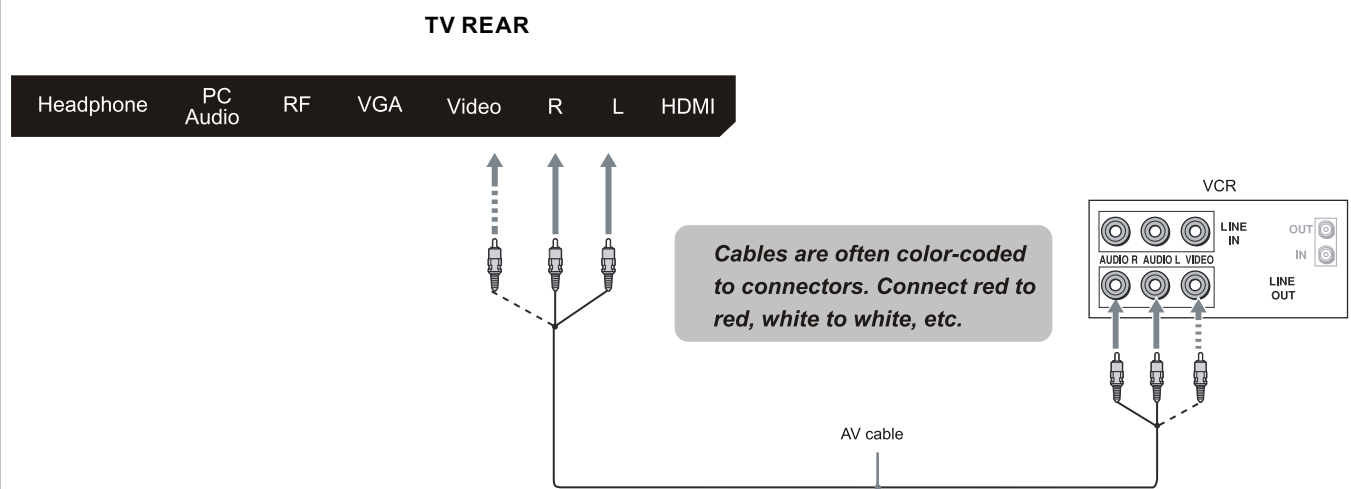

### How to connect:

Connect the Audio/Video cables between the Audio (L/R)/Video jacks on the unit and VCR.

### To play VCR

1. Turn on your TV, then press **SOURCE** button. The **INPUT SOURCE** menu opens.
2. Press **▲** or **▼** to select **AV**, then press **OK** to confirm.
3. Turn on your VCR, insert a videotape and press the **Play** button.

# Connections (Continued)

## Connecting Component Video

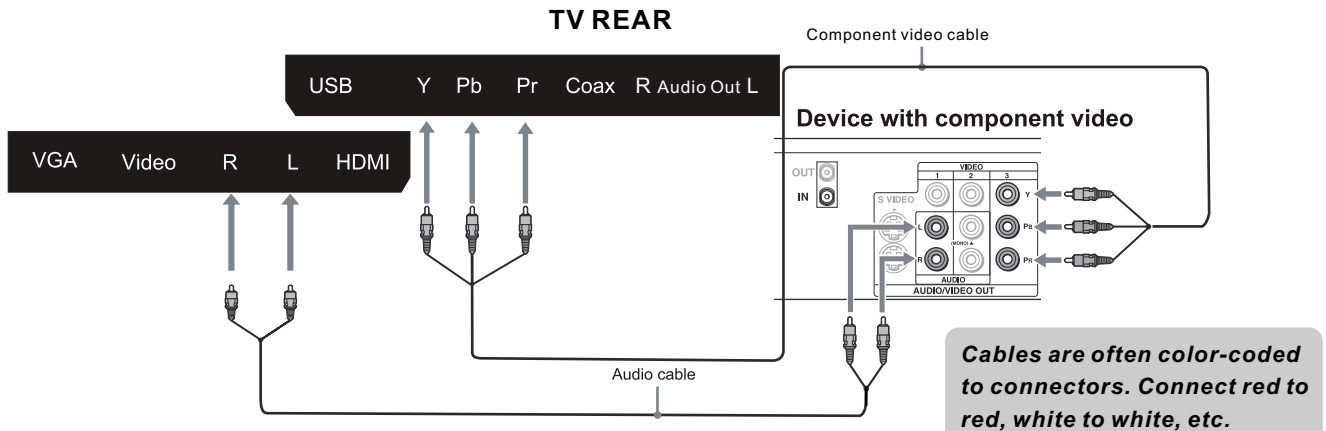

### To connect a device using component video:

Connect the Component Video cable between the Y, Cb/Pb, Cr/Pr input jacks on the unit and Y, Cb/Pb, Cr/Pr output jacks on the device .

Connect the Audio cable between the AUDIO input jacks on the unit and AUDIO output jacks on the device.

### To play component video from an external device:

1. Turn on your TV, then press **SOURCE** button. The **INPUT SOURCE** menu opens.
2. Press **▲** or **▼** to select **YPbPr**, then press **OK** to confirm.
3. Turn on your external device and set it to the correct mode. See the device's user guide for more information.

## Connecting Headphones

Insert the plug of the headphone into the TV's Headphone jack.

When using headphones, adjust the headphone volume so as to avoid excessive levels, as hearing damage may result.

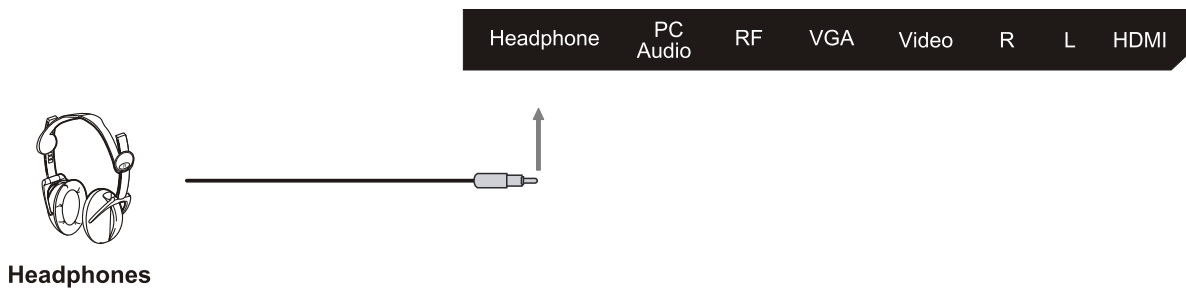

# Connections (Continued)

## Connecting an HDMI device

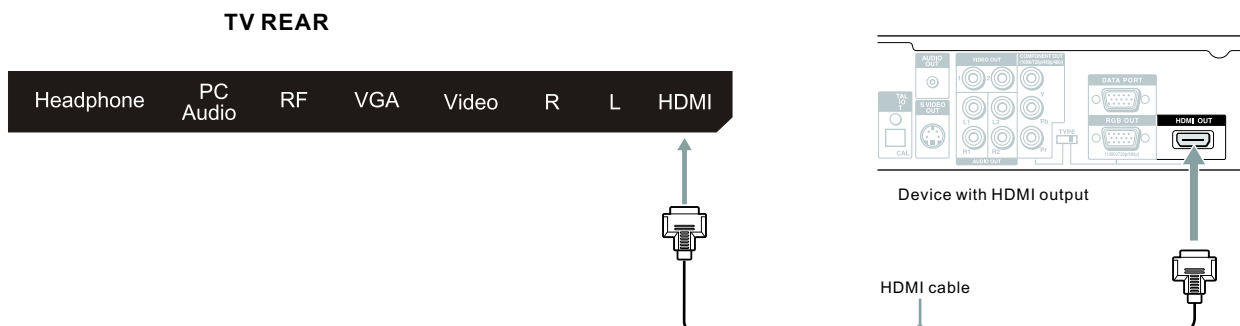

### How to connect a device using HDMI Connection:

Connect the HDMI cable between the HDMI interface on the unit and HDMI output on the device.

### To play from the device using HDMI:

1. Turn on your TV, then press **SOURCE** button. The **INPUT SOURCE** menu opens.
2. Press **▲** or **▼** to select **HDMI**, then press **OK** to confirm.
3. Turn on your device and set it to the correct mode. See the device's user guide for more information.

### Note:

If the external device has DVI output only, use a DVI to HDMI adapter cable to connect to the HDMI terminal. Connect the audio cable to the **VGA AUDIO IN** jack on the TV rear.

## Connecting a Computer

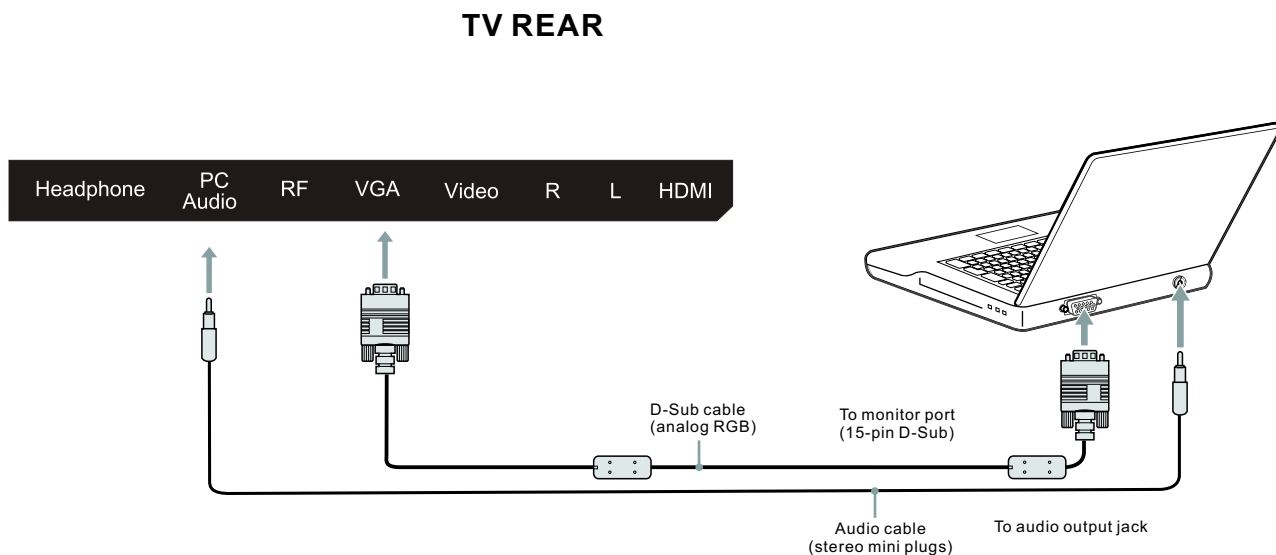

### How to connect:

Connect a VGA cable between the VGA jack on the computer and the VGA input jack on the unit.  
Connect an Audio cable between the AUDIO output on the computer and AUDIO input jack on the unit.

### To play video from a computer

1. Turn on your TV, then press **SOURCE** button. The **INPUT SOURCE** menu opens.
2. Press **▲** or **▼** to select **PC**, then press **OK** to confirm.
3. Turn on your computer, and adjust the display properties as required.

# Basic Operations



In this manual, the OSD ( On Screen Display) may be different from your TV's, because this is just an example for the TV operation.

## Turning On/Off the Power

### ■ Turning On

Insert the power cord into the wall outlet.

Press the **STANDBY** button on the unit or the **ON-OFF** button on the remote control, the unit will be turned on and you will be ready to use its features.

### ■ Turning Off

With the power on, press the **STANDBY** button on the unit or the **ON-OFF** button on the remote control to turn off the unit, and put the unit in standby mode. To cut off the power completely, please disconnect the AC power cord.

**Note:** If there is no signal input for a certain time, the TV will auto go to standby mode.

## Switching Sources

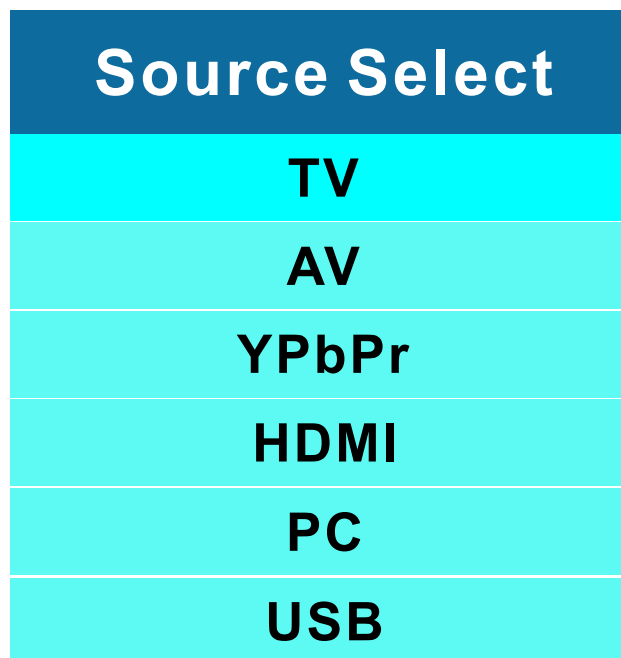

- 1.Press the **SOURCE** button on top of the TV or the **INPUT** button on the remote control and you will see the picture above.
- 2.Use **▲▼** buttons to select the source you want to switch to and press the **OK** button in the middle of the **▲▼** buttons.

# Getting Started



In this manual, the OSD ( On Screen Display) may be different from your TV's, because this is just an example for the TV operation.

## If You've Connected Antenna or Cable to the TV

If an antenna or cable (**without a cable box**) is connected to your TV's tuner, you will need to go through an INITIAL SETUP process in order to watch the TV.

1. Press MENU to open the menu



2. Use the ◀ or ▶ button to select the CHANNEL icon and press **OK**.

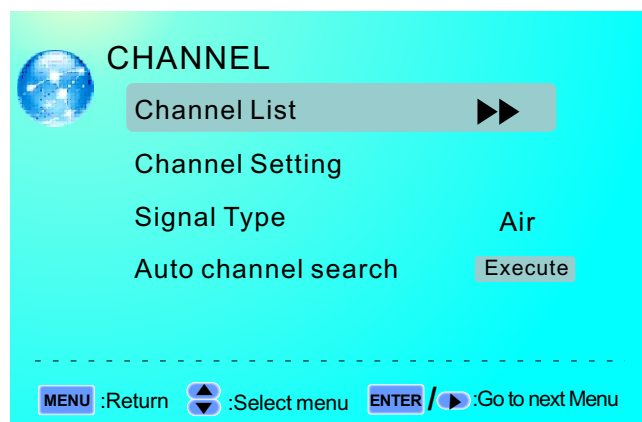

3. Use the ▲ or ▼ buttons to highlight the signal type and press ◀ or ▶ to select your connection either AIR or CABLE.

4. Use the ▲ or ▼ buttons to select AUTO CHANNEL SEARCH and press **OK** to scan for channels.

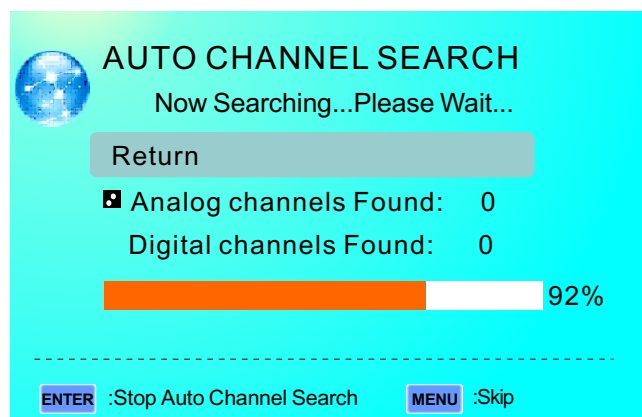

5. Once the scanning finishes, you can begin to watch TV.



## OSD (On Screen Display) Options



**PICTURE** This main option has functions for changing the picture settings for all ports, such as tint, contrast, sharpness.

**SOUND** This main option has functions for changing sound settings for all ports, such as SPDIF Type, treble, bass, and acoustic cinema enhancement....etc.

**CHANNEL** This main option has functions for the tuner port, such as scanning channels, editing channels, specific range scans, audio language, tuner mode....etc.

**PARENTAL** This main option has functions for only composite and TV port. The purpose of this option is to block TV inappropriate for children.

**SETUP** This main option has functions for all ports, OSD language, caption styles, time setup, automatic synchronization, sleep timer and power on timer, power off timer.

**OTHERS** This main option has functions for all ports, OSD language, caption styles, time setup, automatic synchronization, sleep timer and power on timer, power off timer.

### PICTURE

This option allows users to adjust the TV's picture sharpness, color, tint, and other various functions.

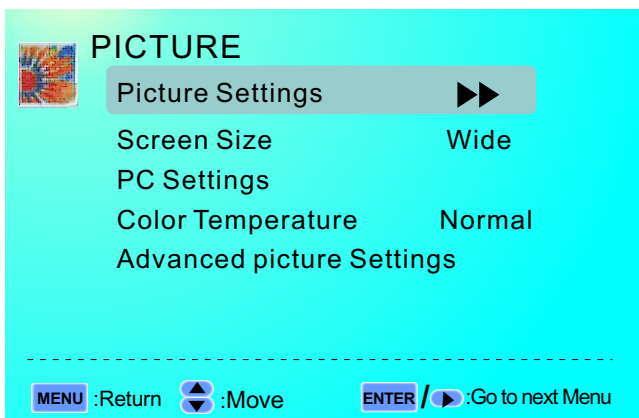

1.Press MENU to open the OSD.

2.Press ◀ or ▶ to select PICTURE and press **OK**.

3.Use ▲ or ▼ to select the one you want to adjust and ◀ or ▶ or **OK** to adjust them.

#### I.PICTURE SETTINGS

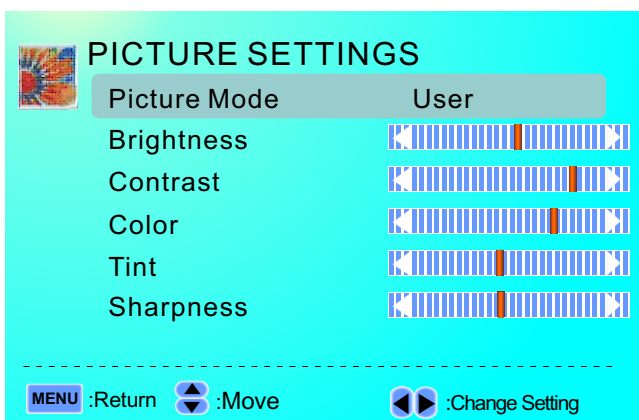

i.PICTURE MODE This feature changes various color modes for the TV.

ii.BRIGHTNESS This feature changes the picture's detail in dark colors.

iii.CONTRAST This feature changes the difference between dark and bright objects.

iv.COLOR This feature changes the amount of color in the picture.

v.TINT This feature changes the white balance of the color.

vi.SHARPNESS This feature changes the picture quality.

# PICTURE

## II.SCREEN Size

I.SCREEN SIZE This featur changes the various aspects of the TV's video.(Aspects include Wide,Cinema,Zoom,Normal.)

## III.PC SETTINGS

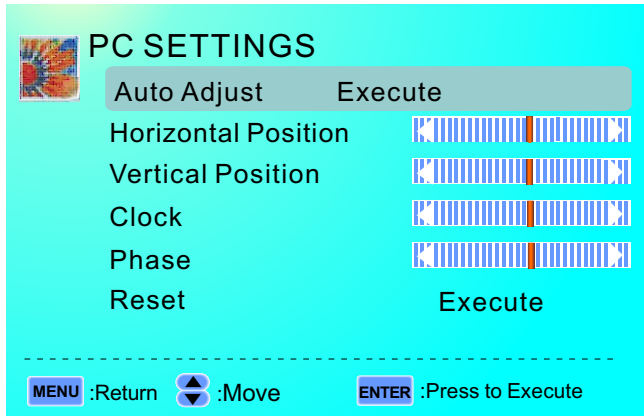

i.AUTO ADJUST This feature automatically adjusts the picture syncing in with the signal of the PC.

ii.HORIZONTAL POSITION This feature adjusts the to the left or right position of the PC picture.

iii.VERTICAL POSITION This feature adjusts the up or down position of the PC picture.

iv.CLOCK This tunes in large increments the picture quality of the PC picture.

v.PHASE This tunes in small increments the picture quality of the PC.

vi.RESET This resets the settings of PC settings.

IV.COLOR TEMPERATURE This feature adjusts the color temperature of the TV, giving warm, normal, cool, (warm being more red, cool being more blue and normal being neutral color).

## V.ADVANCE PICTURE SETTINGS

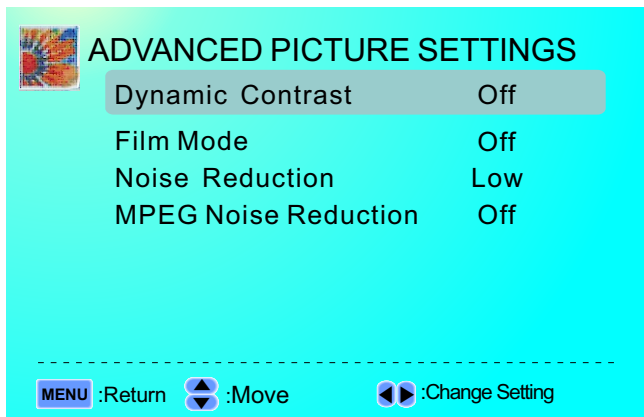

i.DYNAMIC CONTRAST This feature allows the HDTV to automatically adjust the contrast of the HDTV depending on the picture you are viewing.

ii.FILM MODE This feature is **24p** that syncs with DVD movies, and should be enabled when viewing DVD video to allow smoother frame rate.

iii.NOISE REDUCTION This feature reduces general pixilation by blurring them.

iv.MPEG NOISE REDUCTION This feature reduces DVD video pixilation by blurring them.

# SOUND

This option allows users to adjust the TV's sound functions.

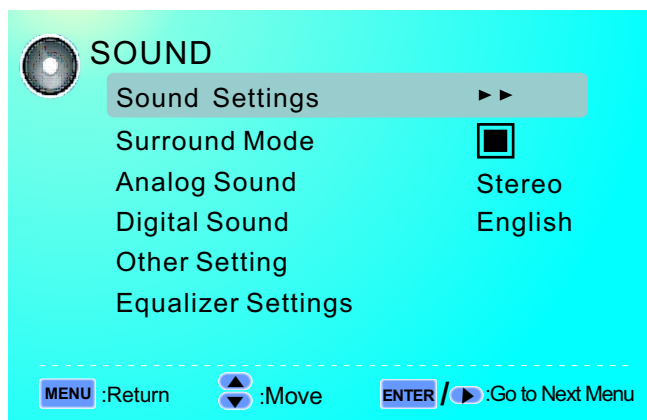

1. Press MENU to open the OSD.

2. Press ◀ or ▶ to select SOUND and press **OK**.

3. Use ▲ or ▼ to select the one you want to adjust and ◀ or ▶ or **OK** to adjust them.

## I. SOUND SETTINGS

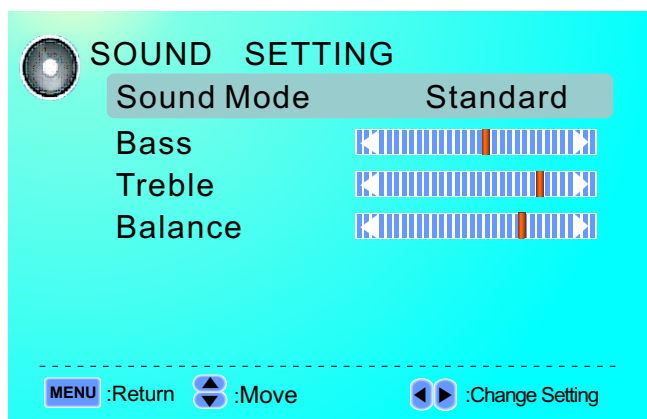

i. **SOUND MODE** This feature switches between preset settings (presets include standard, soft, user, and dynamic).

ii. **BASS** This feature adjusts the audio bass level of the HDTV.

iii. **TREBLE** This feature adjusts the audio treble level of the HDTV.

iv. **BALANCE** This feature adjusts the balance between the two speakers moving sound from left to right.

**II. SURROUND MODE** This feature enables the TV two speakers to provide a wider sound effect.

**III. ANALOG SOUND** This feature adjusts the second audio programming in analog channels.

**IV. DIGITAL SOUND** This feature adjusts the digital second audio programming in digital channels.

**V. Other setting** This feature select the AVL, Speaker and Digital Audio output.

## SOUND

**VI.EQUALIZER SETTINGS** This feature enables the internal equalizer of the speakers. You can adjust the settings individually or use the presets (user, off, rock, pop jazz).

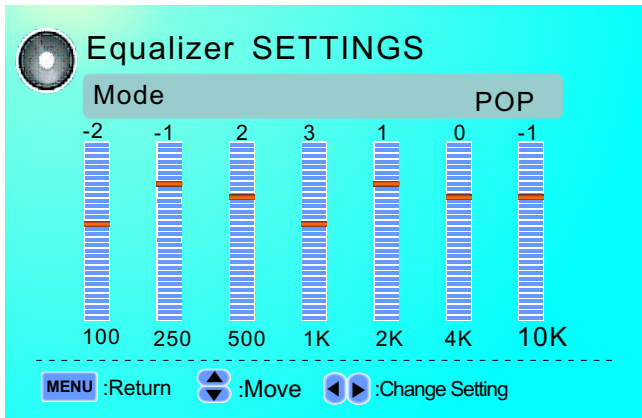

## CHANNEL

This option allows user to adjust the TV's tuner functions.

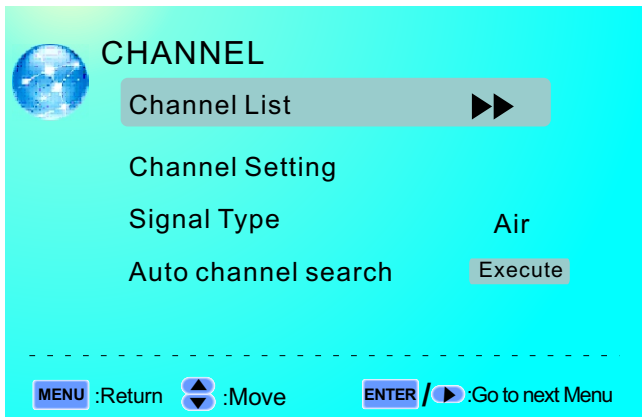

- 1.Press MENU to open the OSD.
- 2.Press ◀ or ▶ to select CHANNEL and press **OK**.
- 3.Use ▲ or ▼ to select the one you want to adjust and ◀ or ▶ or **OK** to adjust them.

**I.CHANNEL LIST** This feature gives you the list of channels currently found by the TV.

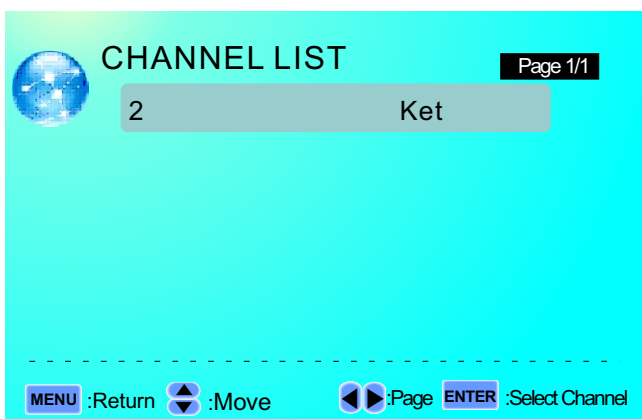

## CHANNEL II.CHANNEL SETTINGS

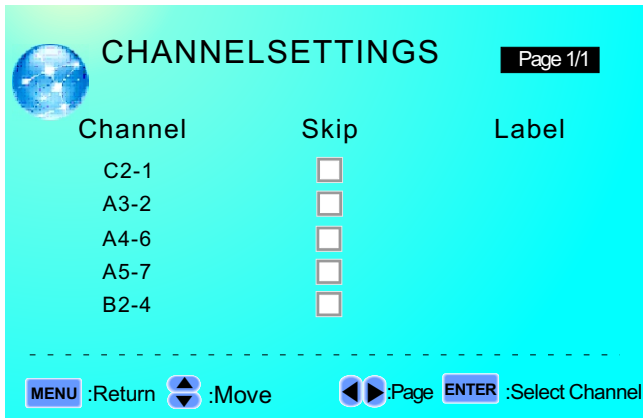

**III.SIGNAL TYPE** This feature allows you to switch between air (such as using antenna) and cable.

**IV.AUTO CHANNEL SEARCH** This feature searches channels automatically for you.

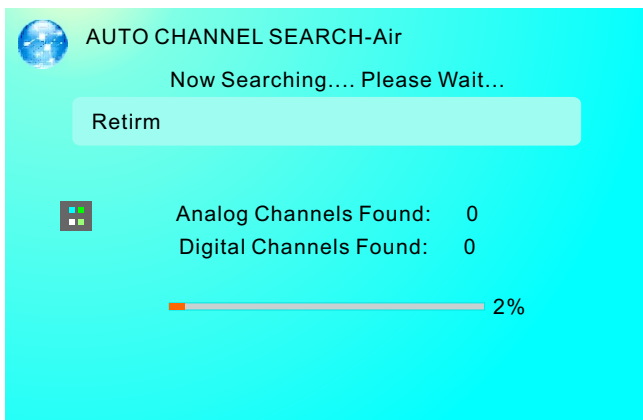

## PARENTAL

This option allows users to filter TV programs and movies while using the TV tuner. To use this option you will need to enter in the password first.

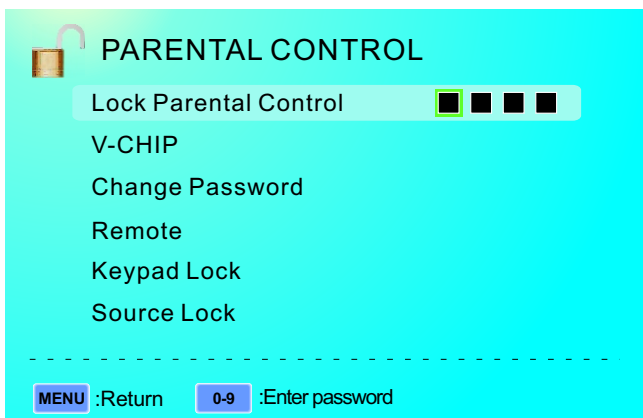

1.Press MENU to open the OSD.

2.Press ◀ or ▶ to select PARENTAL CONTROL and press **OK**.

3.Use ▲ or ▼ to select the one you want to adjust and ◀ or ▶ or **OK** to adjust them.

**I.LOCK PARENTAL CONTROL** This feature allows you to input a password in order to access the other features. (The default password is “0000”)

**II.V-CHIP** This feature can into the submenu to adjust.

**III. CHANGE PASSWORD** This feature changes the password of the parental control function.

**IV.KEYPAD LOCK** This feature locks the buttons on the TV from functioning.

**V.SOURCE LOCK** This feature locks different sources from working.

# SETUP

This option allows user to adjust the TV's miscellaneous options.

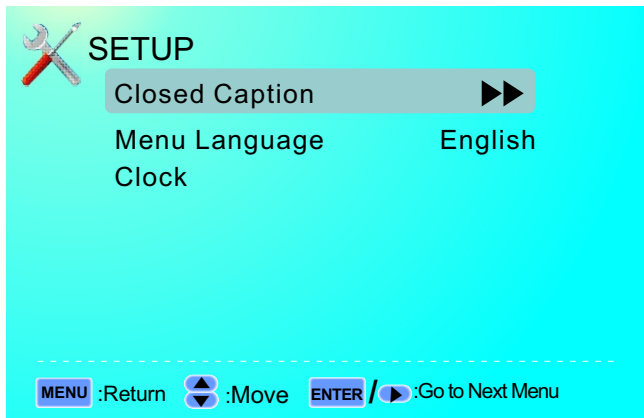

1. Press MENU to open the OSD.
2. Press ◀ or ▶ to select SETUP and press **OK**.
3. Use ▲ or ▼ to select the one you want to adjust and ◀ or ▶ or **OK** to adjust them.

## I. CLOSED CAPTION This provides your TV tuner, AV ports with subtitles.

- i. CAPTION DISPLAY This turns on or off the closed captioning.
- ii. ANALOG CAPTION TYPE This chooses the subchannel that supplies the closed captioning. For United States, usually the setting is CC1. TEXT1-4 displays advertisements of the channel.
- iii. DIGITAL CAPTION TYPE This chooses the subchannel for digital channel closed captioning.
- iv. DIGITAL CC PRESET This unlocks users ability to change caption styles.
- v. DIGITAL CC STYLE This feature changes caption options of digital closed captioning.

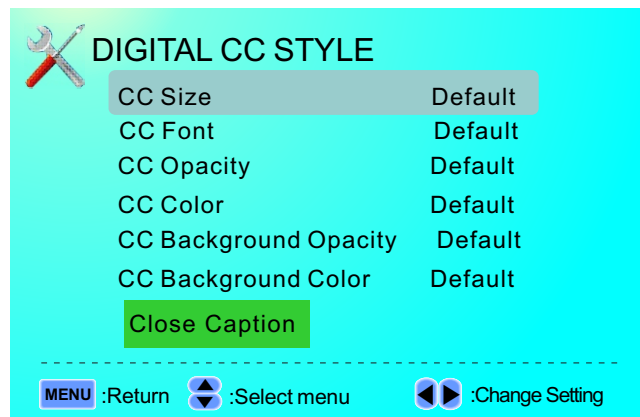

- A) CC OPACITY This changes the transparency of the captioning.  
B) Text COLOR This changes the color of the text.  
C) CC BACKGROUND OPACITY This changes the transparency of background of the text.  
D) CC BACKGROUND COLOR This changes the color of the background.

## II. MENU LANGUAGE This function adjusts the language of the menu (English, French, Spanish).

### III. CLOCK

- i. TIME ZONE This adjusts the time zone for the TV's clock.
- ii. AUTO CLOCK This feature sets the TV to the TV channel's clock. **(You must have antenna to use this feature.)**
- iii. SETUP TIME This feature manually lets you adjust the time and date.
- iv. DAY OF WEEK This feature tells you the day of the week.

## OTHERS

This option allows users to set other features of the TV.

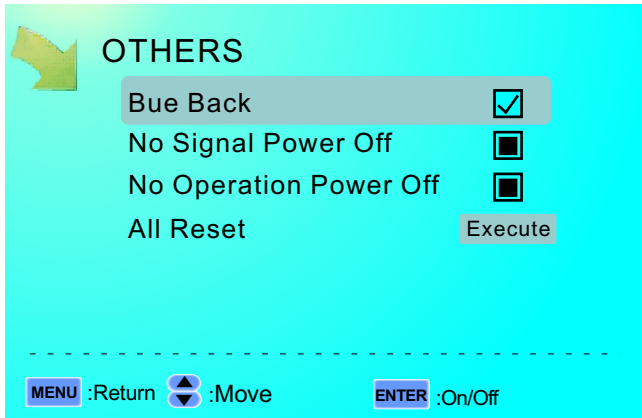

1.Press MENU to open the OSD.

2.Press ◀ or ▶ to select OTHERS and press **OK**.

3.Use ▲ or ▼ to select the one you want to adjust and ◀ or ▶ or **OK** to adjust them.

**I.BLUE BACK** This feature gives the TV a blue default background when there is no signal.

**II.NO SIGNAL POWER OFF** This feature turns the TV off if there is no signal given to the TV after a certain time.

**III.NO OPERATIONS POWER OFF** This feature turns the TV off if there are no commands given to the TV after a certain time.

**IV.ALL RESET** This reset all the options in the MENU back to it's default values.

## USB (Multimedia) Menu

The TV is a widescreen TV with an USB port. With the USB port the TV can access USB flash drives (up to 2GB) and display pictures or play MP3 files. To use this feature connect a USB flash drive to the USB port of the TV and press the INPUT button to select USB source to start browsing for music and pictures.

Once you select the USB input source the USB menu will come up. Select either the music or picture you want to browse using the arrow buttons. Press the OK button to select the file you want.

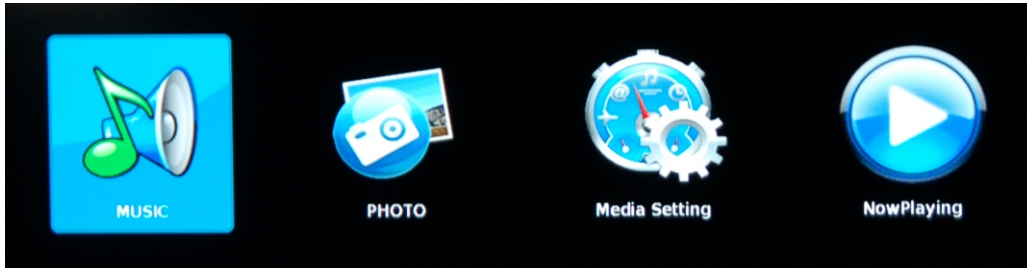

### Browsing Music and Photo

In the USB function, select Music or Photo. Use the ▲ or ▼ button to select the file you want and use the ▶ to play the file. Use the EXIT button to exit a folder.

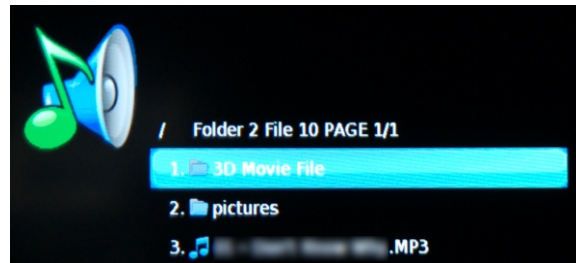

### Media Setting

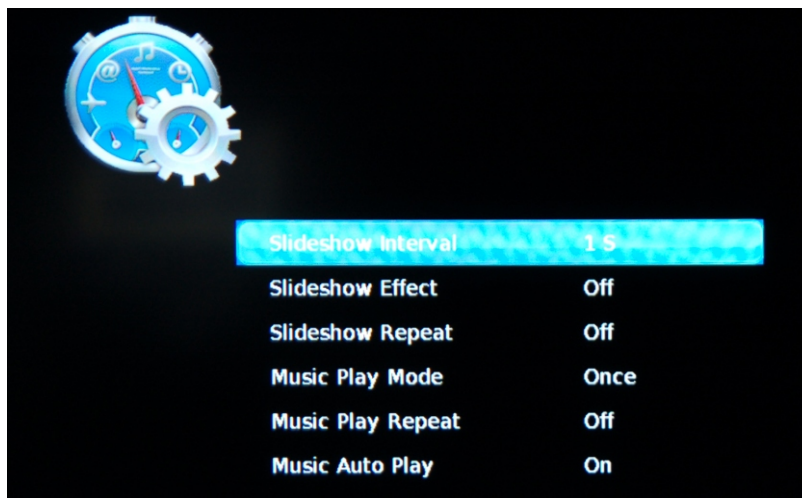

- 1.SLIDESHOW INTERVAL This option adjusts the time interval of a displayed picture.
- 2.SLIDESHOW EFFECT This option adjusts the video effects when pictures interchange.
- 3.SLIDESHOW REPEAT This option toggles the repeat function for displaying pictures.
- 4.MUSIC PLAY MODE This option adjusts the music playing option.
- 5.MUSIC PLAY REPEAT This option toggles the repeat function for playing music.
- 6.MUSIC AUTO PLAY This function toggles the auto play feature which will play any music found in the USB flash drive once you insert the flash drive.

### Technical Limitation

- 1.The USB port does not support USB hubs.
- 2.The USB flash drive supports FAT32 and FAT16 file system only.
- 3.The biggest file size is 4 gigabyte (FAT32).
- 4.The picture function only supports JPEG file (baseline only, progressive is not supported).
- 5.The music function only supports MP3 that is from 32-48khz using a data rate of 32-320 kbps.
- 6.All USB functions are operated by the remote control. None of the buttons physically located on the TV will respond to USB functions.



# Troubleshooting

---

If, after reading these operating instructions, you have additional questions related to the use of your television, please call the services center in your local area.

Before calling service, please check the symptoms and follow suggested solutions.

## Remote Control

<i>Problem</i>	<i>Possible Solutions</i>
Remote control does not operate	<ul style="list-style-type: none"><li>• The batteries could be weak. Replace the batteries.</li><li>• Check the orientation of the batteries.</li><li>• Make sure the power cord is plugged in.</li></ul>

---

## Video and Audio

<i>Problem</i>	<i>Possible Solutions</i>
No picture (screen not lit), No sound	<ul style="list-style-type: none"><li>• Make sure the power cord is plugged in.</li><li>• Press ON-OFF on the TV or on the remote control.</li><li>• Try another channel; it could be station trouble.</li></ul>
Dark, poor or no picture (Screen lit), good sound	<ul style="list-style-type: none"><li>• Select a proper picture mode.</li><li>• Adjust the brightness in the video setting.</li><li>• Check the antenna/cable connections.</li></ul>
No color/dark picture/color is not correct	<ul style="list-style-type: none"><li>• Adjust the color saturation in the video setting.</li></ul>
Only snow and noise appear on the screen	<ul style="list-style-type: none"><li>• Check the antenna/cable connections.</li><li>• Try another channel; it could be station trouble.</li></ul>
Dotted lines or stripes	<ul style="list-style-type: none"><li>• Adjust the antenna.</li><li>• Move the TV away from noise sources such as cars, neon signs, or hair dryers.</li></ul>
Double images	<ul style="list-style-type: none"><li>• Using a highly directional outdoor antenna or a cable may solve the problem.</li></ul>
Good picture, no sound	<ul style="list-style-type: none"><li>• The sound may be muted. Press MUTE again to cancel.</li><li>• Make sure the stereo mode is set to stereo or mono.</li></ul>
Audio noise	<ul style="list-style-type: none"><li>• Communication problems may occur if infrared communication equipment (e.g., infrared cordless headphones) is used near the TV. Move the infrared communication equipment away from the TV until the noise is eliminated.</li></ul>

---

## Troubleshooting (Continued)

---

<i>Problem</i>	<i>Possible Solutions</i>
One or some channels can't be displayed	<ul style="list-style-type: none"><li>• These channels may be blocked. Please unblock them (see &lt;Setting Parental Controls&gt; section).</li><li>• These channels may be set hidden. You may set it to show or select them with 0-9 number buttons.</li></ul>
Some items can't be accessed	<ul style="list-style-type: none"><li>• If a setting option appears in gray, this indicates that the settings option is unavailable in current input mode.</li></ul>
TV cabinet creaks	<ul style="list-style-type: none"><li>• When the TV is in use, there is a natural rise in temperature, causing the cabinet to expand or contract and may be accompanied by a slight creaking noise. This is not a malfunction.</li></ul>
Control buttons do not operate	<ul style="list-style-type: none"><li>• Disconnect the power cord and wait for a few seconds. Then re-plug the power cord and turn on the unit again.</li></ul>

### **Note:**

*If your problem is not solved, turn your unit off and then on again.*

### **Cautions:**

*Never attempt to repair a defective TV yourself.*

## Specifications

---

Panel	22 inches
Pixel pitch	0.24825(H) x 0.24825 (V)
Resolution	1920 x 1080
Aspect Ratio	16 : 9
Display colors	16.7M colors
Contrast	1000:1
Brightness	250 cd/m <sup>2</sup>
Response time	5 ms
Viewing angle	170 (H) / 160(V)
Backlight life	30,000 hours
INPUT	TV/AV/YPbPr/HDMI/PC
Function buttons	STANDBY, SOURCE, MENU, CH-, CH+, VOL-, VOL+
Power supply	100-240V~
Speaker	3w + 3w
Dimensions	532 x 381 x 166 mm
Weight	3.3 Kg

### Note:

1. Design and specifications are subject to change without notice.
2. Weight and dimensions shown are approximate.
3. Specifications and external appearance may be changed for the sake of improvement.

## Wall mounting operation

### Attaching or Removing the TV Stand

1. To attach the base, align the base and the TV. Place the TV's neck on the base and rotate the base shown below. Then insert and tighten the screws shown below.

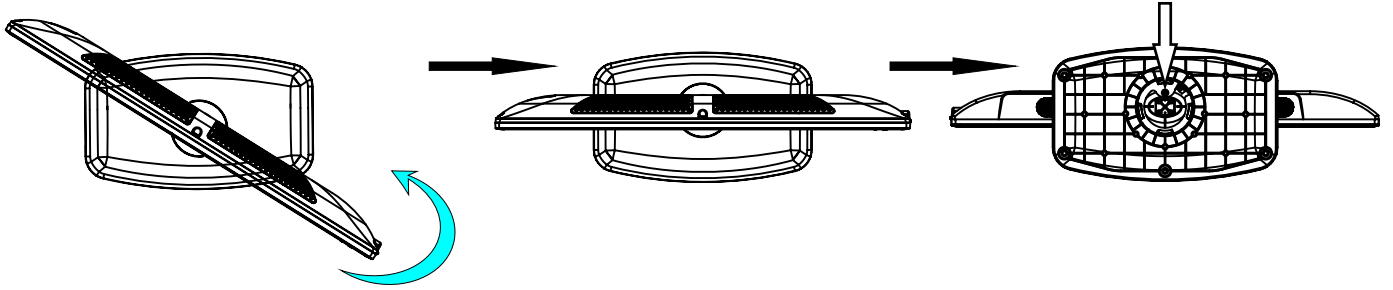

2. To remove the stand, remove the screws in the circled area and the neck will come off.

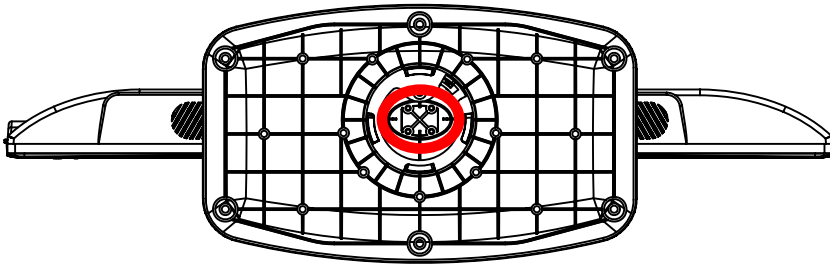

### Rear View Mounting Pattern

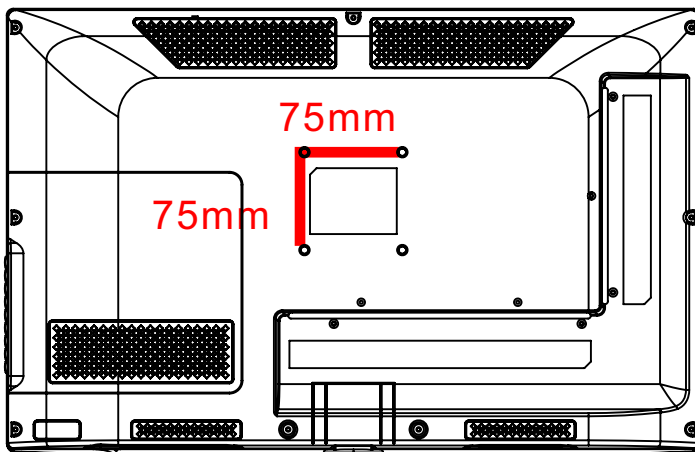

Mounting Specification: **75mm x 75mm** using screw size **M4 (not supplied)**. Length of screw should not exceed **8mm**. Please Note: The **8mm** length of screw refers to how deep the screw can go inside the mounting holes. When you're buying screws, you should add the original **8mm** to the thickness of your mounting plate in order to get the total screw length. **If you are mounting the TV please consult a qualified installer for further instructions on bracket support and wall support.**

## Free Manuals Download Website

<http://myh66.com>

<http://usermanuals.us>

<http://www.somanuals.com>

<http://www.4manuals.cc>

<http://www.manual-lib.com>

<http://www.404manual.com>

<http://www.luxmanual.com>

<http://aubethermostatmanual.com>

Golf course search by state

<http://golfingnear.com>

Email search by domain

<http://emailbydomain.com>

Auto manuals search

<http://auto.somanuals.com>

TV manuals search

<http://tv.somanuals.com>