

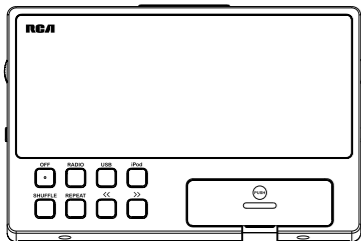

user manual
manual de usuario

RP5500i
RP5502i



EN/E

It is important to read this instruction book prior to using your new product for the first time. Es importante leer este manual antes de usar por vez primera su equipo.

General controls

Front view

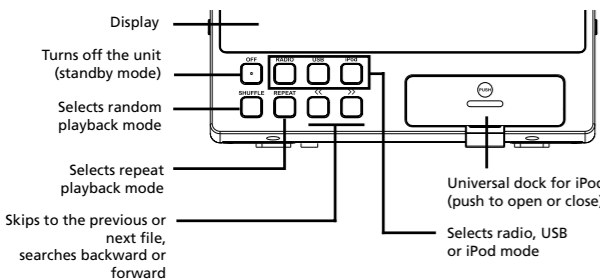

Top view

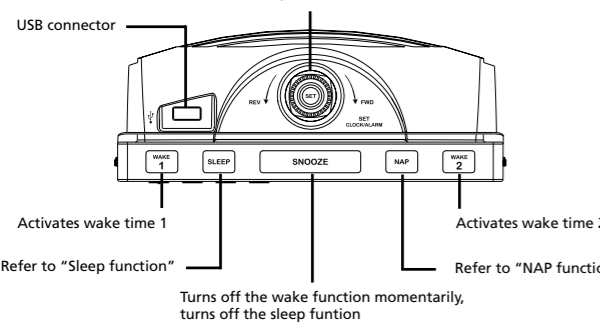

iPod

Listening to iPod

1. Push the universal dock for iPod on the front of the unit to open it.
2. Eight adapters are supplied. Check the table on the right and use the appropriate adapter for your iPod.
3. Place the adapter and then your iPod on the universal dock for iPod.
4. Press **iPod** on the front of the unit to select the iPod mode.
5. Playback from the iPod starts automatically. Press **iPod** to pause the playback and press again to resume. Press << / >> to skip to the previous or next file. Press and hold << / >> to search backward or forward.
6. Press **SHUFFLE** to play the files in random order in the iPod. Random playback indication shows on the iPod when the function is activated. Press again to cancel the function.
7. Press **REPEAT** to select a repeat playback mode (repeat 1 or repeat all). Repeat playback indication shows on the iPod when the function is activated. Press **REPEAT** until no repeat playback indication shows on the iPod to cancel the repeat playback.

Note:

- You may charge the battery of your iPod through the universal dock for iPod while the unit is turned off (standby mode) or in the iPod mode. Charging control should be operated on the iPod.
- If no iPod is connected in the iPod mode, the unit will exit the iPod mode and turn off automatically.

iPods	Adapters
iPod mini 4GB / 6GB	3
iPod 20GB & U2 Special Edition	4
iPod 40GB (4th Generation)	5
iPod photo & color i2 iPod	6
iPod photo with color display 20GB / 30GB	6
iPod photo with color display 40GB / 60GB	7
iPod nano 2GB / 4GB	8
iPod with video 30GB	9
iPod with video 60GB	10

* For the latest iPod models, please use the adapter provided with your iPod.

Make for:

- iPod with video (30GB, 60GB, 80GB) **5th generation**
- iPod photo (20GB U2 Special Edition, 30GB U2 Special Edition, 40GB, 60GB) **4th generation**
- iPod (20GB, 20GB U2 Special Edition, 40GB) **4th generation**
- iPod nano (2GB, 4GB) **1st generation**
- iPod mini (4GB, 6GB) **1st & 2nd generations**

FCC information

This device complies with Part 15 of the FCC Rules. Operation is subject to the following two conditions: (1) This device may not cause harmful interference, and (2) this device must accept any interference received, including interference that may cause undesired operation. In accordance with FCC requirements, changes or modifications not expressly approved by Thomson Inc. could void the user's authority to operate this product. This device generates and uses radio frequency (RF) energy, and if not installed and used properly, this equipment may cause interference to radio and television reception.

If this equipment does cause interference to radio or television reception (which you can determine by unplugging the unit), try to correct the interference by one or more of the following measures:

- Re-orient the receiving antenna (that is, the antenna for the radio or television that is "receiving" the interference).
- Move the unit away from the equipment that is receiving interference.
- Plug the unit into a different wall outlet so that the unit and the equipment receiving interference are on different branch circuits.

If these measures do not eliminate the interference, please consult your dealer or an experienced radio/television technician for additional suggestions. Also, the Federal Communications Commission has prepared a helpful booklet, "How to Identify and Resolve Radio-TV Interference Problems." This booklet is available from the U.S. Government Printing Office, Washington, DC 20402. Please specify stock number 004-000-00345-4 when ordering copies.

For your records

In the event that service should be required, you may need the model number and the serial number. In the space below, record the date and place of purchase and the serial number:
Model No.:
Date of Purchase:
Place of Purchase:
Serial No.:

Service information

This product should be serviced only by those specially trained in appropriate servicing techniques. For instructions on how to obtain service, refer to the warranty included in this user manual.

The AC/DC Adaptor supplied with this product is intended to be correctly orientated in a vertical or floor mount position.

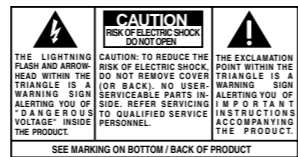

WARNING: TO PREVENT FIRE OR ELECTRICAL SHOCK HAZARD, DO NOT EXPOSE THIS PRODUCT TO RAIN OR MOISTURE.

This Class B digital apparatus complies with Canadian ICES-003. Cet appareil numérique de la class B est conforme à la norme de NMB-003 du Canada.

General controls

Side views

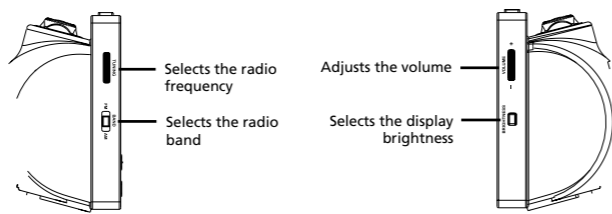

Bottom view

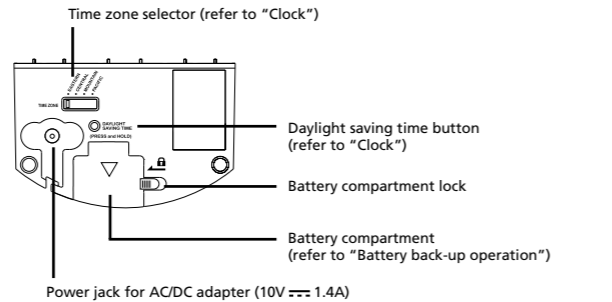

Wake function

Set the wake time

- This unit allows 2 wake times to be set.
1. Press **SET** on the top of the unit until the icon WAKE1 or WAKE2 flashes on the display.
 2. Rotate the knob on the top of the unit to set the wake time. The time decrements or increments follows by a faster rate when you rotate and hold the knob.
 3. To save and exit the wake time setting, wait for about 5 seconds or press **SET** until all clock setting ⌚, WAKE 1 and WAKE 2 icons are off. The wake 1 or wake 2 time is now set.
 - To check the wake time after setting, press **SET** until the icon WAKE1 or WAKE2 flashes and the respective assigned wake time shows on the display.

Select the wake source

You may be woken up by the alarm, radio, music from iPod or USB flash player.

1. Set a wake time (refer to the above instructions).
2. Press **WAKE 1** or **WAKE 2** to select a wake mode. Corresponding icon lights on the front of the unit.

- 1 - Wake time 1 by alarm
- 1 - Wake time 1 by radio
- 1 - Wake time 1 by iPod
- 1 - Wake time 1 by USB flash player
- 2 - Wake time 2 by alarm
- 2 - Wake time 2 by radio
- 2 - Wake time 2 by iPod
- 2 - Wake time 2 by USB flash player

Waking to Alarm (🔔)

- Note:
- The unit equips with **GRAD-U-WAKE** feature, the alarm tone volume will increase gradually to its maximum in about 30 to 45 seconds.
 - If you set the wake function with low volume level before going to bed, we advise using Waking to Alarm mode to wake you up since the volume will automatically increase.
 - When the AC power is disconnected, all wake mode will be reverted to alarm tone.

- Waking to RADIO (📻)
3. Select a desired wake up radio channel (refer to "Listening to the radio"). If no wake up channel is set, your last listening radio station will be selected.
 4. Adjust the volume to your desired level.
 5. Press **OFF** to turn off the unit.

Waking to iPod (📱)

3. Adjust the volume to your desired level. The last played file on the iPod will be played when the wake function activates.
4. Press **OFF** to turn off the unit.

Note: If there is no iPod connected, the alarm tone will sound instead even if Waking to iPod mode is selected.

PLEASE READ AND SAVE THIS FOR FUTURE REFERENCE
IMPORTANT SAFETY INSTRUCTIONS

Some of the following information may not apply to your particular product; however, as with any electronic product, precautions should be observed during handling and use.

- Read these instructions.
- Keep these instructions.
- Heed all warnings.
- Follow all instructions.
- Do not use this apparatus near water.
- Clean only with dry cloth.
- Do not block any ventilation openings. Install in accordance with the manufacturer's instructions.
- Do not install near any heat sources such as radiators, heat registers, stoves, or other apparatus (including amplifiers) that produce heat.
- Do not defeat the safety purpose of the polarized or grounding-type plug. A polarized plug has two blades with one wider than the other. A grounding type plug has two blades and a third grounding prong. The wide blade or the third prong is provided for your safety. If the provided plug does not fit into your outlet, consult an electrician for replacement of the obsolete outlet.
- Protect the power cord from being walked on or pinched particularly at plugs, convenience receptacles, and the point where they exit from the apparatus.
- Only use attachments/accessories specified by the manufacturer.
- Use only with the cart, stand, tripod, bracket, or table specified by the manufacturer, or sold with the apparatus. When a cart is used, use caution when moving the cart/apparatus combination to avoid injury from tip-over.
- Unplug this apparatus during lightning storms or when unused for long periods of time.
- Refer all servicing to qualified service personnel. Servicing is required when the apparatus has been damaged in any way, such as power-supply cord or plug is

damaged, liquid has been spilled on objects have fallen into the apparatus, the apparatus has been exposed to rain or moisture, does not operate normally, or has been dropped.



- **ADDITIONAL SAFETY INFORMATION**
- Apparatus shall not be exposed to dripping or splashing and no objects filled with liquids, such as vases, shall be placed on the apparatus.
- Always leave sufficient space around the product for ventilation. Do not place product in or on a bed, rug, in a bookcase or cabinet that may prevent air flow through vent openings.
- Do not place lighted candles, cigarettes, cigars, etc. on the product.
- Connect power cord only to AC power source as marked on the product.
- Care should be taken so that objects do not fall into the product.
- Do not attempt to disassemble the cabinet. This product does not contain customer serviceable components.
- **IF YOUR PRODUCT OPERATES ON BATTERIES**, adhere to the following precautions:
 - A. Any battery may leak electrolyte if mixed with a different battery type, if inserted incorrectly, or if all batteries are not replaced at the same time.
 - B. Any battery may leak electrolyte or explode if disposed of in fire or an attempt is made to charge a battery not intended to be recharged.
 - C. Discard leaky batteries immediately. Leaking batteries can cause skin burns or other personal injury. When discarding batteries, be sure to dispose of them in the proper manner, according to your state/provincial and local regulations.

Clock

Auto clock set

You do not have to set the clock time as a built-in automatic time system is equipped in this clock powered by 3V (2 AA batteries, included and installed). All you have to do is to plug this clock for power and current time will be shown automatically after setting the time zone and daylight saving time (read below). However, the batteries can also be exhausted and we recommend that you replace the batteries every 2-3 years.

Setting time zone

Slide the time zone selector at the bottom of the unit to Eastern, Central, Mountain or Pacific time zone (refer to the maps on the right).

Daylight saving time

Press and hold the Daylight Saving Time button at the bottom of the unit to turn on/off in areas observing not observing such time change. The icon ☀ shows on the display when daylight saving time is active.

WARNING: Avoid playing with these buttons when setting clock or wake time.

Display brightness

Press **BRIGHTNESS** to dim the display and press again to restore to the original brightness level. When the display is dimmed, the blue indicator on the universal dock for iPod will also be turned off.

Important information

Safety precautions

- Make sure that you keep your set away from water and high temperatures.
- Do not use your system immediately after transporting it from a cold place to a warm place, as condensation may cause the system to malfunction.
- Keep your unit away from humid areas and abnormally hot places.
- To prevent personal injury, do not reverse any batteries.
- The use of apparatus in moderate climates.
- The apparatus should not be exposed to dripping or splashing and no objects filled with liquids, such as vases, should be placed on the apparatus.
- Attention should be drawn to the environmental aspects of battery disposal.
- Minimum distances (2cm) should be kept around the apparatus for sufficient ventilations.
- The ventilation should not be impeded by covering the ventilation opening with items, such as newspaper, tablecloths, curtains, etc.
- The rating plate is located at the bottom cabinet of apparatus.

Technical information

Product: Clock Radio
Brand: RCA
Model: RP5500i, RP5502i

Electrical consumption

External AC adaptor: 10V ~ 1.4A
Power consumption: 120VAC x 0.7A

The descriptions and characteristics in this owner's manual are for the purpose of general reference only and not as a guarantee. In order to provide you with the highest quality product, we may make changes or modifications without prior notice. The English version serves as the final reference on all product and operational details should any discrepancies arise in other languages.

iPod is a trademark of Apple Computer, Inc., registered in the U.S. and other countries.

Maintenance

Clean the unit with a soft cloth, or a damp chamois leather. Never use solvents.

Clock

US time zones



Canadian time zones

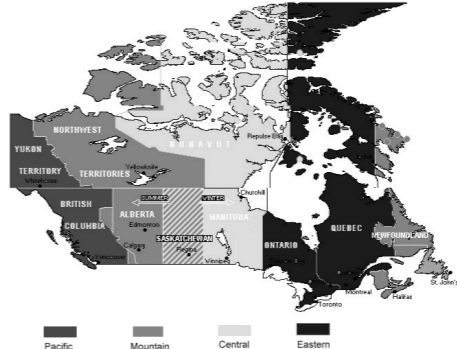

Sleep function

In the sleep mode, the radio, iPod or USB flash player (if connected) turns off automatically. To set the sleep time, simply:

1. Press **SLEEP** repeatedly to cycle among the sleep time available (90min, 60min, 30min, 15min and OFF. 90min is the default setting).
- If necessary, press << / >> to further set the sleep time. Each press of the button will decrease or increase one minute. For example, to set 35 min, press **SLEEP** to select 30min and then press >> 5 times.
- The icon flashes while selecting.
2. When the desired sleep time is selected, release **SLEEP** and wait for about 5 seconds, the sleep time is now set. The radio (default) turns on and the icon lights on the display.

NAP function

For catnaps up to 2 hours without disturbing the regular alarm settings, the NAP function wakes you up after a short period of time. Simply:

1. Press **NAP** repeatedly to cycle among the NAP time available (10min, 20min, 30min, 60min, 90min, 120min and OFF. 20min is the default setting).
- If necessary, press << / >> to further set the NAP time. Each press of the button will decrease or increase one minute. For example, to set 35min, press **NAP** to select 30 min and then press >> 5 times.
- The icon NAP flashes while selecting.

Getting started

Plugging in for power

Insert the connector of the AC/DC adapter to the power jack at the bottom of the unit. External AC/DC adaptor input power supply: 100-240V ~ 50/60Hz

Note:

Power is fed to the unit even when it is not functioning. To cut the power supply off, the power cable must be unplugged.

Battery back-up operation

This clock radio is equipped with a memory holding system that can be powered with 2 "AA" batteries (included). The power failure protection circuit will not operate unless battery is installed. When normal household power is interrupted, or AC line cord is unplugged, the batteries will power the clock radio to keep track of time and alarm settings programmed into memory. When the battery backup functions, the digital display will not light, however, the function of alarm still occurs during the power interruption if remaining battery power is adequate. Normal operation will resume after AC power is restored so you will not have to reset the time or the alarm.

Install battery as follow:

1. Remove battery compartment door (located at the bottom of the radio) by applying thumb pressure to the tab on battery door and then lift the door out and off the cabinet.
2. Insert 2 AA battery (included).
3. Replace the compartment door.

Note: we recommend that you replace the batteries every 2-3 years.

Radio & USB

Listening to the radio

1. Press **RADIO** on the front of the unit to turn on the radio.
2. Slide **BAND** to select the radio band. The selected radio band shows on the display.
3. Rotate **TUNING** to select frequency. The selected frequency shows on the display.
4. Press **OFF** to turn off the radio.

Built-in AFC

The Built-in Automatic Frequency Control (AFC) works only on FM. It helps reducing drift on FM reception and keeping the clock locked in on the FM station to which it is tuned.

When tuning in FM stations, you may notice that the station you are tuning can be well-tuned on two or three nearby points on the dial. Always tune carefully at the loudest and clearest point.

AM Antenna

A built-in ferrite rod antenna eliminates the need for an outside antenna for AM reception. Rotating the unit slightly may improve reception of distant AM stations.

Listening to the external USB flash player

1. Connect an external USB flash player (with mp3 music) to the USB connector at the top of the unit.
2. Press **USB** on the front of the unit to select the USB mode.
3. Playback from the USB flash player starts automatically. Press **USB** to pause the playback (the TRACK icon flashes during pause) and press again to resume.

U.S. Limited Warranty

What your warranty covers:
• Defects in materials or workmanship.
For how long after your purchase:
• 90 days from date of purchase - unit exchange, which includes parts and labor.
• 91 days to 1 year from date of purchase - unit exchange, which includes parts only; you pay the labor.

What we will do:
• Provide you with a new, or at our option, a refurbished unit. The exchange unit is under warranty for the remainder of the original product's warranty period.
• Proof of purchase in the form of a bill of sale or receipted invoice which is evidence that the product is within the warranty period must be presented to obtain warranty service. For rental firms, proof of first rental is also required.

How to make a warranty claim:
• Properly pack your unit. Include any cables, etc., which were originally provided with the product. We recommend using the original carton and packing materials.
• Include evidence of purchase date such as the bill of sale. Also print your name and address and a description of the defect.
• Send via standard mail or its equivalent to: Thomson Inc., Product Exchange Center, 11721 B Alameda Avenue, Socorro, Texas 79927

What your warranty does not cover:
• Customer instruction. (Your Owner's Manual provides information regarding operating instructions and user controls. For additional information, ask your dealer.)
• Installation and set-up service adjustments.
• Batteries.
• Damage from misuse or neglect.
• Products which have been modified or incorporated into other products.
• Products purchased or serviced outside the USA.

Power failure indicator

When external DC power is interrupted (disconnected) for a short period of time, both time and alarm settings will change (unless batteries are installed). After external DC power is restored (reconnected), the Digital Display will blink to indicate that power was interrupted and you should readjust the time and alarm settings.

IMPORTADOR
Comercializadora Thomson de México, S.A. de C.V.
Álvaro Obregón No. 151. Piso 13.
Col. Roma. Delegación Cuauhtémoc
C.P. 06700. México, D.F.
Telefono: 52-55-11-020360
RFC: CTM-980723-K55

EXPORTER
Thomson Inc.
P.O. Box 1976
Indianapolis, IN 46206 - 1976
©2007 Thomson Inc.
Trademark(s) © Registered

Marque(s) @ Deposited(s)
Marca(s) @ Registrada(s)
www.rcaaudiovideo.com
Printed in China / Impreso en China

Free Manuals Download Website

<http://myh66.com>

<http://usermanuals.us>

<http://www.somanuals.com>

<http://www.4manuals.cc>

<http://www.manual-lib.com>

<http://www.404manual.com>

<http://www.luxmanual.com>

<http://aubethermostatmanual.com>

Golf course search by state

<http://golfingnear.com>

Email search by domain

<http://emailbydomain.com>

Auto manuals search

<http://auto.somanuals.com>

TV manuals search

<http://tv.somanuals.com>