

PLAYING A DISC

This user manual explains the basic instructions for operating this unit. Some DVDs are produced in a manner that allows specific or limited operation during playback. Therefore, this unit may not respond to all operating commands. THIS IS NOT A DEFECT. Please refer to the instructions

accompanying the specific DVD in question for more information about the options available on that DVD. A screen may appear on the screen during operation. It means that the desired operation is not permitted by the unit or disc.

Playing a Disc

- Press the **STANDBY / ON** button to turn on the unit. See **CUSTOMIZING THE FUNCTION SETTINGS** before proceeding to step 2.
- Press the **OPEN/CLOSE** button to open the disc tray.
- Place a disc onto the disc tray with the label side up.
- Press the **OPEN/CLOSE** button to close the disc tray. It takes a short while for your unit to load the disc. After loading, for most DVDs, the unit will automatically take you main menu or start playing.
- If the unit does not automatically start playing the DVD, press the **PLAY** button.

Pausing Playback (Still Mode)

Press the **PAUSE** button on the remote. To resume normal playback, press the **PLAY** button. Each time you press the **PAUSE** button, the picture advances one frame.

Stopping Playback

- Press the **STOP** button at the location where you want to interrupt playback. To resume playback at the position where the disc was stopped, press the **PLAY** button.
- If you press the **STOP** button twice, the unit's memory will be cleared and pressing the **PLAY** button will reset the disc to the beginning.

Fast Forward / Fast Reverse

- Press the **SEARCH** or **SEARCH** button when a disc is playing. Each time you press the **SEARCH** or **SEARCH** button, the playback speed changes in the following sequence:

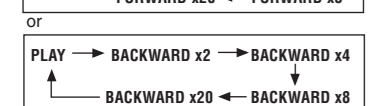
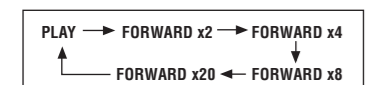

- Press the **PLAY** button when you reach the desired point to resume normal playback.

Notes:

- The unit mutes sound and subtitles during reverse and forward scan of DVDs.
- The fast playback speed may differ depending on the disc.

Skipping to a Different Chapter/Title

- Press the **PREV** button to go back to current or previous chapters/tracks.
- Press the **NEXT** button to advance chapters/tracks.
- For audio CDs, use the number buttons on the remote control to jump immediately to the desired track number.

Slow-motion Play

- Press the **SLOW** button on the remote in play mode.
- Each time the **SLOW** button is pressed, the speed of slow-motion playback changes in the following sequence:

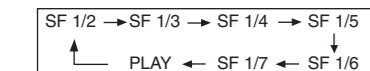

- After approx. two seconds, playback will continue from the new angle you selected.
- If no button is pressed within 10 seconds, playback continues without changing the current angle.

Notes:

- This function can only be used for discs on which scenes shot from multiple angles have been recorded.
- If only one angle is recorded, "1/1" is displayed.

Zooming into an image

- While a disc is playing, press the **ZOOM** button to enlarge the image in several levels.
- While an image is zoomed, you can use the **▲**, **▼**, **◀** or **CURSOR** button to shift the view and display the part you want.
- To return to normal view, press the **ZOOM** button until the "ZOOM: OFF" shows. The screen will return to normal.
- When you reach the edge of the image, the display will not shift anymore in that direction.

Display Function

While the disc is playing, press the **DISPLAY** button on the remote control repeatedly to display information on operation status.

e.g.

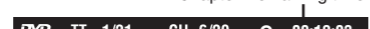
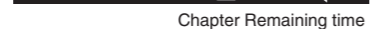

LOCATING A DESIRED SECTION

Locating a specific chapter / track

If you know the chapter / track number you want to play, you can locate a specific chapter / track by directly selecting a chapter / track number.

- Press the **GOTO** button to search your desired chapter / track.
- Press **◀** or **▶** button to highlight a chapter / track and press the corresponding number button(s) for the chapter you want.
- Press the **OK** button to confirm. The unit will start playback about 3 seconds later.

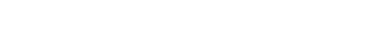
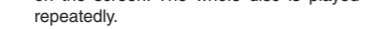
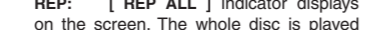
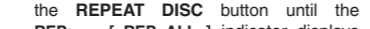
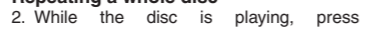
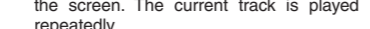
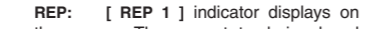
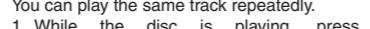
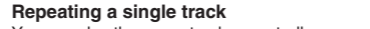
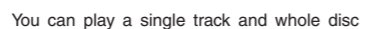
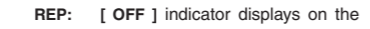
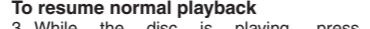
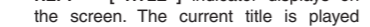
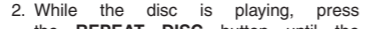
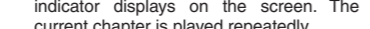
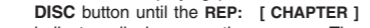
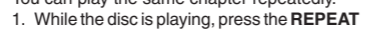
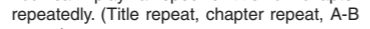
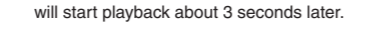
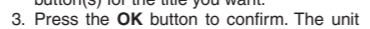
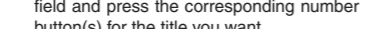
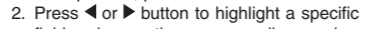
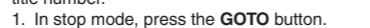
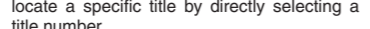
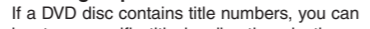

Elapsed Time:
Elapsed time from the beginning of the chapter/title which is currently playing.

Remaining Time:
Remaining time of the chapter/title which is currently playing.

Chapter Remaining time

Title Elapsed time

Total time

Notes:

- Some discs may not respond to this process.
- Some scenes may not be located as precisely as you specified.
- This method for accessing specific locations is available only within the current title of the DVD disc.

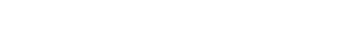
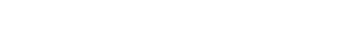
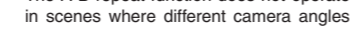
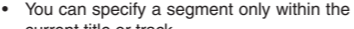
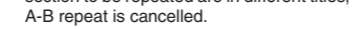
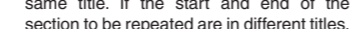
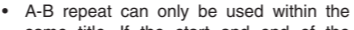
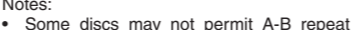
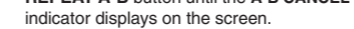
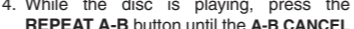
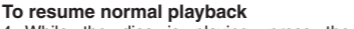
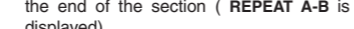
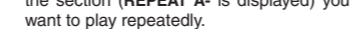
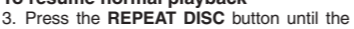
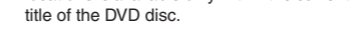
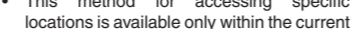
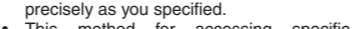
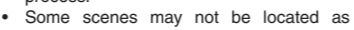
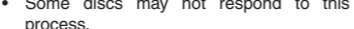
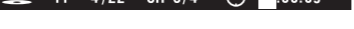

PROGRAMMABLE MEMORY

The two types of programmed playback provided by this unit are title/chapter programmed playback and track programmed playback.

Title / Chapter programmed playback

- Press the **MEMORY** button.
- Enter the title numbers in [] . Use **▶** button to move the highlight to chapter and enter the chapter numbers in [] .
- Use **▲**, **▼**, **◀** or **▶** button to move to the other field.
- Repeat steps 2 to 3.
- Press the **PLAY** button to start the programmed playback.

Note: If you press the **STOP** button twice, the programmed selection will be cleared.

Track programmed playback

- Press the **MEMORY** button.
- Enter the track numbers in [] .
- Use **▲**, **▼**, **◀** or **▶** button to other field.
- Repeat steps 2 to 3.
- Press the **PLAY** button to start the programmed playback.

PLAYING PICTURE FILE DISC

This unit can play picture files recorded on CD-R and CD-RW discs.

Playing a Picture File Disc

- Open the disc door.
- Place a picture file disc onto the tray with label side up.
- Close the disc door.
- The unit will load the disc and automatically display the contents of the disc on the screen, while playing the beginning of the first picture file. These files will then be played back one by one.
- Press **◀** or **▶** button to select a picture file to view.
- Press the **▲**, **▼**, **◀** or **▶** CURSOR button to view and select the files that you want to view, then press the **OK** button to confirm the selected file.

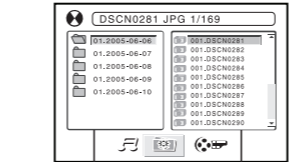

Folders Files within the current folder

- You can press the **PAUSE** button to interrupt playback, and press the **PLAY** button to resume playback.
- You can use the **GOTO** function or use the numbered buttons to enter the number of a picture file to quickly select the image.
- Press the **ANGLE** button on the remote control to rotate the picture orientation by 90°.

iPod FEATURES

iPod Dock Adapter

Before connecting your iPod, you need to install the appropriate iPod Dock Adapter (supplied with the iPod) in the dock of the unit.

Installing the iPod Dock Adapter

- Push to open the iPod docking door.
- Place your iPod Dock Adapter into the dock until it sits firmly in place.

Removing the iPod Dock Adapter

- Remove the iPod Dock Adapter as shown.
- Replace it with another one you need.

Connecting your iPod

- Ensure the appropriate iPod Dock adapter that was supplied with your iPod is installed.
- Insert your iPod into the connector in the dock.
- Press the **SOURCE** button to select the iPod mode. Your iPod will be connected automatically, and iPod Home menu appears.

Important:

Before docking your iPod, MAKE SURE your iPod has the latest FIRMWARE.

Notes:

- Some discs may not permit A-B repeat operation.
- A-B repeat can only be used within the same title. If the start and end of the section to be repeated are in different titles, A-B repeat is cancelled.
- You can specify a segment only within the current title or track.
- The A-B repeat function does not operate in scenes where different camera angles are recorded.

- Press **REPEAT DISC** button to select a repeat playback mode (a single repeat or all songs repeat). Press again repeatedly to cancel this repeat playback.
- Press the **RETURN** button to go back to the previous menu.

Playing Photos

- In iPod Home menu, use the **▼ / ▲** button to select Photos and press the **OK** button. "Navigate your iPod Photo Library directly from your iPod" will appear on the screen.

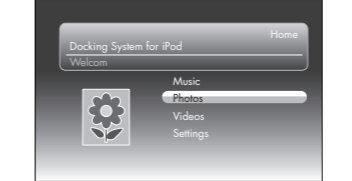

- Use the **▼ / ▲** button to navigate the iPod menu lists and select a photo, press the **OK** button to begin playback. (You may also use the control wheel and keys on your iPod to operate it.)
- Press the **PAUSE** button to pause, press the **PLAY** button to resume.
- Press the **REVERSE** / **FAST** button to skip to the previous / next photo.
- Press the **RETURN** button to go back to the previous menu.

Using an iPod Touch to view the photo

- In iPod Home menu, use the **▼ / ▲** button to select Photos and press the **OK** button. "Navigate your iPod Photo Library directly from your iPod" will appear on the screen.
- Touch the "Photos" selection on iPod panel, and then select the photo your prefer.
- Touch the "▶" to confirm the photo.
- Touch the "Yes" to activate iPod's video output. The photo will appear on the screen.

Step 2



Step 3



Step 4

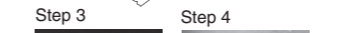

Step 2



Step 3



Step 4

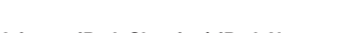
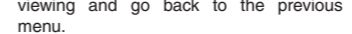

Step 2

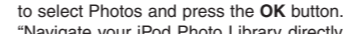
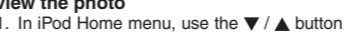

Step 3

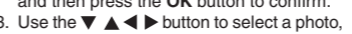
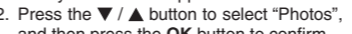

Step 4

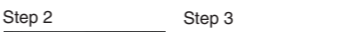

Step 2



Step 3

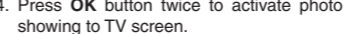

Step 4

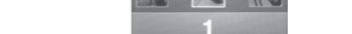



User manual

DRC300i



SAFETY PRECAUTIONS

Caution Marking and rating plate was located at rear enclosure of the apparatus.

CAUTION RISK OF ELECTRIC SHOCK DO NOT OPEN. CAUTION: TO REDUCE THE RISK OF ELECTRIC SHOCK, DO NOT REMOVE COVER (OR BACK). NO USER-SERVICEABLE PARTS INSIDE.

The lightning flash with an arrowhead symbol, within the equilateral triangle, is intended to alert the user to the presence of uninsulated "dangerous voltage" within the product's enclosure that may be of sufficient magnitude to cause an electric shock.

The exclamation point within the equilateral triangle is intended to alert the user to the presence of important operating and maintenance (servicing) instructions in this user manual.

CAUTION INVISIBLE LASER RADIATION WHEN OPEN AND INTERLOCKS DEFEATED. AVOID EXPOSURE TO BEAM.

CLASS 1 LASER PRODUCT. The symbol for Class II (Double Insulation). This product contains a low power laser device.

On Placement

- Do not use the unit in places that are extremely hot, cold, dusty, or humid. The ventilation should not be impeded by covering the ventilation openings with items such as newspaper, table-cloths, curtains, etc. When connecting or disconnecting the AC power cord, grip the plug and not the cord itself. Pulling the cord may damage it and create a hazard. When you are not going to use the unit for a long period of time, disconnect the AC power cord. No naked flame sources such as lighted candles should be placed on the AC power cord and the unit. Leave a minimum of 10 cm around the apparatus for ventilation. Attention should be drawn to the environmental aspects of battery disposal. Use of apparatus in moderate climates.

On Condensation

- When left in a heated room where it is warm and damp, water droplets or condensation may form inside the unit. When there is condensation inside the unit, the unit may not function normally. Let the unit stand for 1 to 2 hours before turning the power on, or gradually heat the room and let the unit dry before use.

Rating Plate Location

- The rating plate is located on the rear of unit.

WARNING. Should any trouble occur, disconnect the AC power cord and refer servicing to a qualified technician. Main plug is used as the disconnect device, it shall remain readily operable and should not be obstructed during intended use. To be completely disconnected the apparatus from supply mains, the main plug of the apparatus shall be disconnected from the mains socket outlet completely.

Notes on Copyright

It is forbidden by law to copy, broadcast, show, broadcast on cable, play in public, or rent copyrighted material without permission. Apparatus Claims of U.S. Patent Nos. 6,836,549; 6,381,747; 7,050,698; 6,516,132; and 5,583,936 licensed for limited viewing uses only.

This product incorporates copyright protection technology that is protected by U.S. patents and other intellectual property rights. Use of this copyright protection technology must be authorized by Macrovision, and is intended for home and other limited viewing uses only unless otherwise authorized by Macrovision. Reverse engineering or disassembly is prohibited.

IMPORTANT SAFETY INSTRUCTIONS

- 1. Read these instructions. 2. Keep these instructions. 3. Heed all warnings. 4. Follow all instructions. 5. Do not use this apparatus near water. 6. Clean only with a dry cloth. 7. Do not block any of the ventilation openings. Install in accordance with the manufacturer's instructions. 8. Do not install near any heat sources such as radiators, heat registers, stoves, or other apparatus (including amplifiers) that produce heat. 9. Do not defeat the safety purpose of the polarized or grounding - type plug. A polarized plug has two blades with one wider than the other. A grounding type plug has two blades and a third grounding prong. The wide blade or the third prong is provided for your safety. When the provided plug does not fit into your AC power outlet, consult an electrician for replacement of the obsolete outlet. 10. Protect the AC power cord from being walked on or pinched particularly at plugs, convenience receptacles, and the point where they exit from the apparatus.

- 11. Only use attachments/accessories specified by the manufacturer. 12. Use only with a cart, stand, tripod, bracket, or table specified by the manufacturer, or sold with the apparatus. When a cart is used, use caution when moving the cart/apparatus combination to avoid injury from tip-over. 13. Unplug this apparatus during lightning storms or when unused for long periods of time. 14. Refer all servicing to qualified service personnel. Servicing is required when the apparatus has been damaged in any way, such as the AC power cord or plug is damaged, liquid has spilled or objects have fallen into the apparatus, the apparatus has been exposed to rain or moisture, does not operate normally, or has been dropped.



Portable Cart Warning

DISC FORMATS

The unit can playback:

Table with 4 columns: DVD VIDEO [8cm/12cm disc], Audio CDs [8cm/12cm disc], CD-R CD-RW Compatible.

Region Management Information

This unit is designed and manufactured to respond to the Region Management Information that is encoded on DVDs. If the region number printed on the DVD does not correspond to the region number of this unit, it cannot play that disc.

The region number of this unit is 1.

Disc Function or Operation that is Not Available

When the [Hand] appears on the screen, it indicates that the function or operation attempted is not available at that time. This occurs because the DVD manufacturer determines the specific functions of DVDs. Certain functions may not be available on some DVDs. Be sure to read the documentation provided with the DVD.

Icons Used on DVDs

- Language selections for audio, Language selections for subtitles, Screen aspect ratio, Multiple camera angles, Region code indicator.

Note: When playing back a CD-G (Graphics) or CD EXTRA disc, the audio portion will be played, but the graphic images will not be shown.

SOUND SYSTEM

Dolby Digital

Dolby Digital is a technology developed by Dolby Laboratories. Soundtracks encoded in Dolby Digital can reproduce from one to 5.1 discrete channels of excellent quality audio. The unit automatically recognizes the Dolby Digital bitstream and provides a downmix suitable for two-channel listening. An additional Dolby Digital decoder is required for reproduction of the discrete multi-channel soundtracks available on many DVDs.

Manufactured under license from Dolby Laboratories. 'Dolby' and the double-D symbol are trademarks of Dolby Laboratories.



ACCESSORIES

Please check and identify the supplied accessories.

- Remote Control x 1, 2xAAA batteries x 1, AV cable x 1.

REMOTE CONTROL

Using the Remote Control

- Point the remote control at the REMOTE SENSOR located on the unit. When using this unit in very bright light, the infrared REMOTE CONTROL SENSOR may not work properly. The recommended effective distance for remote operation is about 16 feet (5 meters).

Battery Replacement

When the batteries become weak, the operating distance of the remote control will be greatly reduced and you will need to replace the batteries.

Notes:

- If the remote control is not going to be used for a long time, remove the batteries to avoid damage caused by battery leakage corrosion. When discarding batteries, environmental problems must be considered and local rules or laws governing the disposal of these batteries must be strictly followed.

To Change Remote Batteries

- 1. Open the battery door. 2. Insert two AAA size batteries.

WARNING: Do not dispose of the battery in fire or it may explode or leak. Batteries shall not be exposed to excessive heat such as sunshine, fire or the like.

CAUTION: Danger of explosion if battery is incorrectly replaced. Replace only with the same or equivalent type.

TROUBLESHOOTING GUIDE

Table with 2 columns: SYMPTOM, CAUSE (AND REMEDY). Rows include: No power, The remote control does not function, No sound or only a very low-level sound is heard, No picture or abnormal color, No output on your HDMI TV, Severe hum or noise is heard, The disc does not play.

No output on your HDMI TV.

Severe hum or noise is heard.

The disc does not play.

The DVD door cannot open.

MAINTENANCE

Cleaning the Disc

- A defective or soiled disc inserted into the unit can cause sound to drop out during playback. Handle the disc by holding its inner and outer edges. Do NOT touch the surface of the unlabeled side of the disc. Do NOT stick paper or tape on the surface. Do NOT expose the disc to direct sunlight or excessive heat. Clean the disc before playback. Wipe the disc from the center outward with a cleaning cloth. NEVER use solvents such as benzene or alcohol to clean the disc. Do NOT use irregular shaped discs (example: heart shaped, octagonal, etc.). They may cause malfunctions.

Cleaning the Unit

- Be sure to turn the unit off and disconnect the AC power cord before maintaining the unit. Wipe the unit with a dry soft cloth. If the surfaces are extremely dirty, wipe clean with a cloth that has been dipped in a weak soap-and-water solution and wrung out thoroughly, then wipe with a dry cloth. Never use alcohol, benzene, thinner, cleaning fluid or other chemicals. Do NOT use compressed air to remove dust.

Important Note

Before transporting the unit, remove the disc from the disc compartment.

CONTROL REFERENCE GUIDE

Remote Control

- OPEN/CLOSE Button: Press to open or close the disc tray. STANDBY/ON Button: Press to turn on the unit or put it in standby mode. AUDIO Button: Press to select one of the audio sound tracks programmed on a DVD or to select the audio output mode on an audio CD. ANGLE Button: Press to switch the camera angle of the video presentation when scenes with multiple camera angles are recorded on a DVD. MEMORY Button: Press to create programs. Press to rotate JPG files in iPod mode. DISPLAY Button: Press to change disc status information displayed on the TV screen. SETUP Button: Press to open and close the SETUP menu screen. CURSOR (Up, Down, Left, Right) Button: Press to highlight selections on a menu screen and adjust certain settings. OK Button: Press to confirm selections on a menu screen. CLEAR Button: Clear input selections and cancel certain playback functions. Press to select iPod's "Remote UI mode" or "Extended Interface mode". PLAY Button: Press to start playback. STOP Button: Press to stop playback. SEARCH Button: Fast reverse playback. REV Button: Press to move backwards through titles, chapters or tracks on a disc. Number (0-9) Buttons: A-B REPEAT Button: Press to perform point-to-point repeat playback on a DVD or CD. SOURCE Button: Selects input sources. SUBTITLE Button: Press to select one of the subtitle languages programmed on a DVD. ZOOM Button: Zoom in an image.

Unit

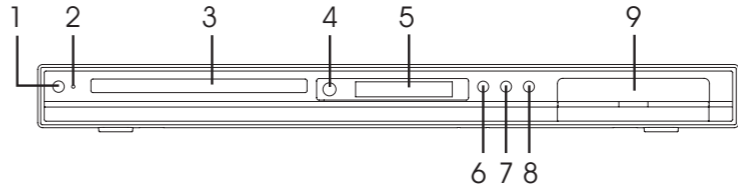

- 1. STANDBY/ON Button: Turn the unit on or put it in standby mode. Power Indicator: Indicator On: The unit is in standby mode. Indicator Off: The unit is turned on. 2. DISC TRAY: Opens or closes the tray by pressing the OPEN/CLOSE button. 3. REMOTE SENSOR: Receives the remote control unit signals. 4. DISPLAY LENS: Display units information. 5. OPEN/CLOSE Button: Opens or closes the tray. 6. PLAY Button: Starts or resumes playback of a disc. 7. STOP Button: Stop playing a disc. 8. iPod dock door: Push to open the iPod dock. 9. DISPLAY LENS: Display units information.

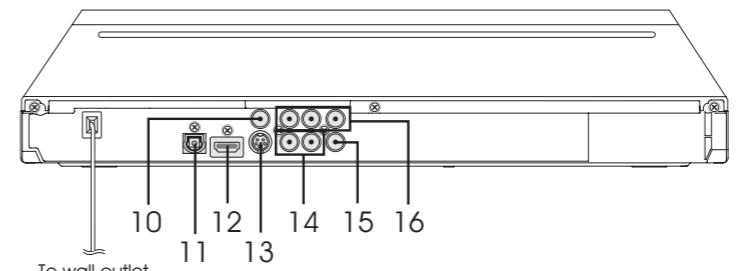

- 10. VIDEO OUT jack, 11. OPTICAL OUT jack, 12. HDMI OUT jack, 13. S-VIDEO jack, 14. LEFT/RIGHT AUDIO OUT jacks, 15. COAXIAL DIGITAL AUDIO OUT jack, 16. COMPONENT VIDEO OUT jacks (Y, Pb & Pr).

SETUP AND CONNECTIONS

CONNECTING TO A TV

The unit can be connected to your TV in several different ways, depending on the design of your TV. Note: Use only one of the below listed connection method for connecting to your TV.

A. RCA AUDIO/VIDEO JACKS

- 1. Use the Audio/Video cable (supplied). Connect the VIDEO OUT and left/right AUDIO OUT jacks on the unit to the VIDEO IN and left/right AUDIO IN jacks on your TV. 2. Use the S-video cable (not supplied). If the TV has a S Video input, connect the unit with an S video cable. When using an S-Video cable, do not connect the yellow video cable and component video cables (Y/Pb/Pr).

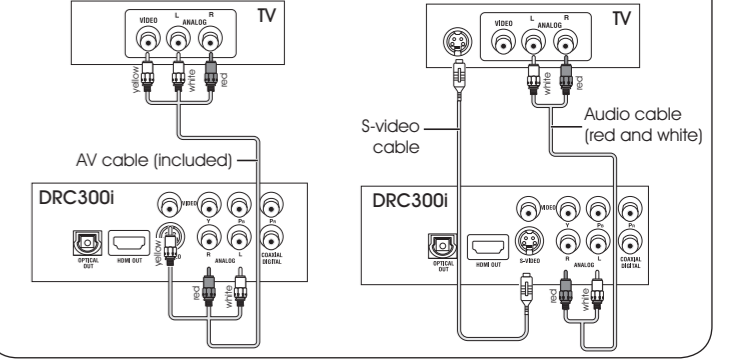

B. COMPONENT VIDEO OUT (DVD)

Some TVs or monitors are equipped with component video inputs. Use an audio cable (not supplied), connect the left/right AUDIO OUT jacks on your unit to the left/right AUDIO IN jacks on your TV.

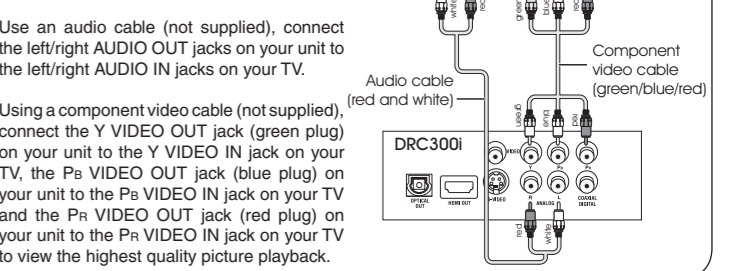

C. CONNECTING TO A DISPLAY (Using a HDMI cable)

For TVs that support it, HDMI can provide the best quality audio and video output (depending on media source), and so is the preferred connection type. The HDMI cable incorporates both audio and video signals, so you will have just one cable running from the unit to your TV.

- Press the HDMI button on the remote control to change output signals as below: 480p (progressive), 720p (progressive), 1080i (interlace), 1080p (progressive).

Using the HDMI cable (not included), connect the HDMI OUT jack on your unit to the HDMI IN jack on your TV or HDMI-compatible display.

- When using the HDMI cable, do not connect to other analog video outputs. Set an output signal from the HDMI terminal of the DVD player in accordance with your TV's input signal. When using HDMI cable, set the HDMI Audio to PCM.

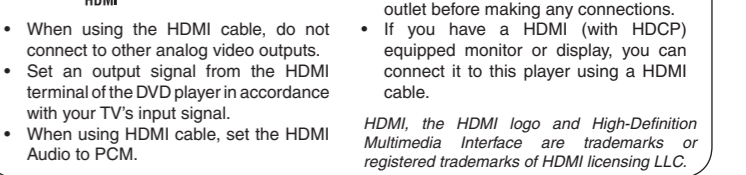

CONNECTING TO OPTIONAL EQUIPMENT (AMPLIFIER)

A. ANALOGUE CONNECTION

Using an audio/video cable, connect the left/right AUDIO OUT jack on your unit to the AUDIO IN jack on your other source.

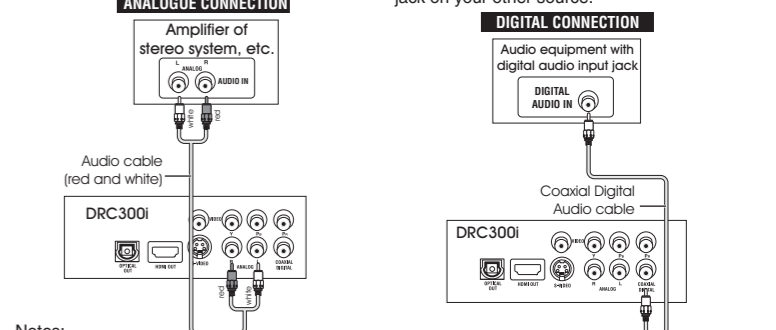

- When you connect the unit to other equipment, be sure to turn off the power and unplug all of the equipment from the wall outlet before making any connections. If the external equipment is television and this audio system is close to it, you may experience the interference if the tuner function is selected while the television is working. Refer to the instruction manual of the connected equipment as well.

Free Manuals Download Website

<http://myh66.com>

<http://usermanuals.us>

<http://www.somanuals.com>

<http://www.4manuals.cc>

<http://www.manual-lib.com>

<http://www.404manual.com>

<http://www.luxmanual.com>

<http://aubethermostatmanual.com>

Golf course search by state

<http://golfingnear.com>

Email search by domain

<http://emailbydomain.com>

Auto manuals search

<http://auto.somanuals.com>

TV manuals search

<http://tv.somanuals.com>