

DRC6282 EN

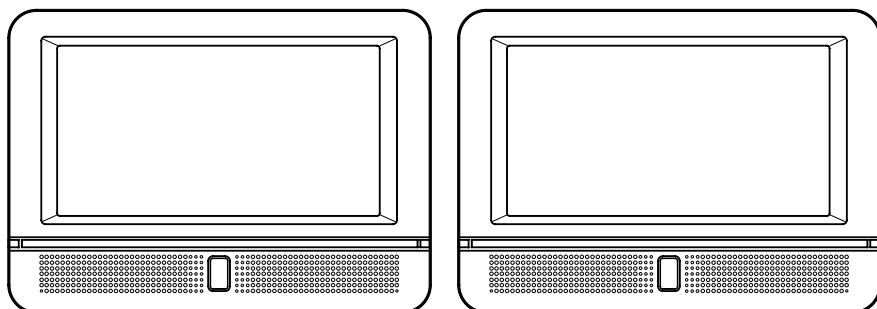

It is important to read this instruction book prior to using your new product for the first time.

Safety Precautions



Warning:

To reduce the risk of electric shock, do not remove cover (or back). No user-serviceable parts inside. Refer servicing to qualified service personnel. To prevent fire or shock hazard, do not expose this unit to rain or moisture. Do not place objects filled with liquids on or near this unit.

 The lightning flash with arrowhead symbol, within an equilateral triangle, is intended to alert the user to the presence of uninsulated "dangerous voltage" within the product's enclosure that may be of sufficient magnitude to constitute a risk of electric shock to persons.

 The exclamation point within an equilateral triangle is intended to alert the user to the presence of important operating and maintenance (servicing) instructions in the literature accompanying the appliance.

Caution:

- This product utilizes a laser. Use of controls or adjustments or performance of procedures other than those specified herein may result in hazardous radiation exposure. Do not open covers and do not repair yourself. Refer servicing to qualified personnel.
- Danger of explosion if battery is incorrectly replaced. Replace only with the same or equivalent type.
- Invisible laser radiation when open. Avoid exposure to beam. Class 1 laser product. This system must be opened only by qualified technicians to prevent accidents caused by the laser beam.



This product contains a low power laser device.



Placement information

- Do not use this unit in places that are extremely hot, cold, dusty, or humid.
- Do not restrict the airflow of this unit by placing it somewhere with poor airflow, by covering it with a cloth, or by placing it on bedding or carpeting.

Safety information

- When connecting or disconnecting the AC power adapter or car power adapter, grip the power plug and not the cord itself. Pulling the cord may damage it and create a hazard.
- When you are not going to use the unit for a long period of time, disconnect the AC power adapter or car power adapter.

Condensation information

When left in a heated room where it is warm and damp, water droplets or condensation may form inside the unit. When there is condensation inside the unit, the unit may not function normally. Let the unit stand for 1-2 hours before turning the power on or gradually heat the room and allow the unit to dry before use.

WARNING: Should any problems occur, disconnect the AC power adapter or Car power adapter and refer servicing to a qualified technician.

Additional safety information

- Apparatus should not be exposed to dripping or splashing liquids and no objects filled with liquids, such as vases, should be placed on the apparatus.
- Always leave sufficient space around the product for ventilation. Do not place product in or on a bed, rug, in a bookcase or cabinet that may prevent air flow through vent openings.
- Do not place lighted candles, cigarettes, cigars, etc. on the product.
- Connect power cord only to AC power source as marked on the product.
- Care should be taken so that objects do not fall into the product.
- Do not attempt to disassemble the cabinet. This product does not contain customer serviceable components.

EN

If your product operates on batteries, adhere to the following precautions:

- A. Any battery may leak electrolyte if mixed with a different battery type, if inserted incorrectly, or if all batteries are not replaced at the same time.
- B. Any battery may leak electrolyte or explode if disposed of in fire or an attempt is made to charge a battery not intended to be recharged.

- C. Discard leaky batteries immediately. Leaking batteries can cause skin burns or other personal injury. When discarding batteries, be sure to dispose of them in the proper manner, according to your state/provincial and local regulations.

FCC Information

This device complies with Part 15 of the FCC Rules. Operation is subject to the following two conditions: (1) This device may not cause harmful interference, and (2) this device must accept any interference received, including interference that may cause undesired operation.

This equipment has been tested and found to comply with the limits for a Class B digital device, pursuant to Part 15 of FCC Rules. These limits are designed to provide reasonable protection against harmful interference in a residential installation. This equipment generates, uses, and can radiate radio frequency energy and, if not installed and used in accordance with the instructions, may cause harmful interference to radio communications.

However, there is no guarantee that interference will not occur in a particular installation. If this equipment does cause harmful interference to radio or television reception, which can be determined by turning the equipment off and on, the user is encouraged to try to correct the interference by one or more of the following measures:

- Reorient or relocate the receiving antenna.
- Increase the separation between the equipment and receiver.
- Connect the equipment into an outlet on a circuit different from that to which the receiver is connected.
- Consult the dealer or an experienced radio/TV technician for help.

WARNING:
Changes or modifications to this unit not expressly approved by the party responsible for compliance could void the user's authority to operate the equipment.

This product complies with DHHS Rules 21 CFR Subchapter J. Applicable at the date of manufacture.

Important Safety Precautions

Please read and save for future reference

Some of the following information may not apply to your particular product; however, as with any electronic product, precautions should be observed during handling and use.

1. Read these instructions.
2. Keep these instructions.
3. Heed all warnings.
4. Follow all instructions.
5. Do not use this apparatus near water.
6. Clean only with a dry cloth.
7. Do not block any ventilation openings. Install in accordance with the manufacturer's instructions.
8. Do not install near any heat sources such as radiators, heat registers, stoves, or other apparatus (including amplifiers) that produce heat.
9. Do not defeat the safety purpose of the polarized or grounding-type. A polarized power plug has two blades with one wider than the other. A grounding type power plug has two blades and a third grounding prong. The wide blade or the third prong is provided

for your safety. When the provided power cord does not fit into your AC power outlet, consult an electrician for replacement of the obsolete outlet.

10. Protect the AC power cord from being walked on or pinched particularly at the power plug, convenience receptacles, and the point where they exit from the apparatus.
11. Only use attachments/accessories specified by the manufacturer.
12. Use only with the cart, stand, tripod, bracket, or table specified by the manufacturer, or sold with the apparatus. When a cart is used, use caution when moving the cart/apparatus combination to avoid injury from tip-over.
13. Unplug this apparatus during lightning storms or when unused for long periods of time.
14. Refer all servicing to qualified service personnel. Servicing is required when the apparatus has been damaged in any way, such as the AC power cord is damaged, liquid has spilled or objects have fallen into the apparatus, the apparatus has been exposed to rain or moisture, does not operate normally, or has been dropped.



EN

Accessories

Please locate the included accessories.

To order replacement units, visit <http://www.1800customersupport.com/RCA>

- Remote control (with battery) x 2
- Car power adapter splitter x 1
- Car power adapter x 1
- AC power adapter x 2
- AV cable x 1
- Straps x 2

Table of Contents

EN

Safety precautions	1 - 2	Playing JPEG files	15
FCC information	2	DVD programmable playback	16
Important safety instructions	3	Customizing the DVD function settings	16
Accessories	3	Language setup	
Table of contents	4	Video setup	
Getting started	5	System setup	17
Remote control reference guide ..	6	Additional information	18
Unit reference guide	7	Troubleshooting	
Power supply	8	Compatible formats	19
Using the car power adapter		Notes on copyright	
Using the AC power adapter	8	Sound system	
Connections	9	Precautions	20
Connecting unit to a TV		Use	
Listening to a stereo receiver or amplifier on unit		Cleaning	
Playing a game systems / video equipment on unit	10	Handling and caring for discs	
.....		Limited warranty	22
Playing a DVD on unit A and B			
Using headphones / earphones			
Placement	11		
Mounting in the vehicle			
Using the stand	12		
Unit operation	12		
Turning the unit on			
Playing discs - basic functions	13		
Compatible discs			
Compatible formats			
Regional coding			
Basic playback operations			
Playback			
Pausing playback (still mode)			
Stopping playback			
Skipping to a different track			
Audio selection (DVD)			
Subtitle selection (DVD)			
Angle selection (DVD)	14		
Special functions	14		
Display function (DVD)			
Locating a specific title (DVD)			
Locating a specific chapter / track			
Locating a specific time			
Repeat playback	15		
Repeating a chapter (DVD)			
Repeating a title (DVD)			
Repeating a single track (CD)			
Repeating a specific section (DVD/CD)			

Getting Started

Remove the plastic sheet before operating the remote control.

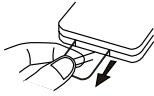

Using the remote control

- Point the remote control at the REMOTE SENSOR located on the unit.
- When using this unit in bright light, the infrared REMOTE CONTROL SENSOR may not work properly.
- The recommended effective distance for using the remote control is about 16 feet.

To change remote battery

1. Open the battery door.

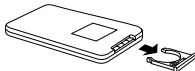

2. Insert one CR2025 (3V) size battery.



Caution:

Danger of explosion if battery is incorrectly replaced. Replace only with the same or equivalent type.

Battery replacement

When the battery becomes weak, the operating distance of the remote control will be greatly reduced and you will need to replace the battery.

Important battery information

- Do not mix different types of batteries or new and old batteries. Do not use rechargeable batteries.
- In order to avoid any risk of explosion, observe the polarities indicated inside the battery compartment. Replace only with the type of batteries specified. Do not dispose of them in a fire or recharge them.
- If you are not using the remote control for a long period of time, remove the batteries.
- Battery should not be exposed to excessive heat such as sunshine, fire or the like.

Please respect the environment and prevailing regulations. Before you dispose of batteries, ask your dealer whether they are subject to special recycling and if they will accept them for disposal.



Illustrations contained in this document are for representation only.

EN

Remote Control Reference Guide

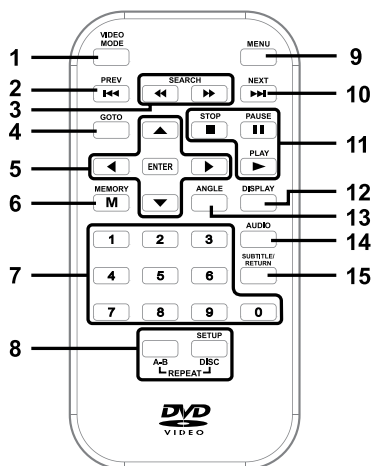

Note:

The included remote controls have different color keys to identify which unit they operate. The remote control with green keys operates Unit A which has a green stripe on the front of the unit. The remote control with blue keys operates Unit B, with a similar blue stripe on the front of the unit.

1) VIDEO MODE button

Press to adjust Brightness, Panel Display or Contrast of the unit of screen. Press to adjust Brightness and use the ▼ button to select other.

2) I◀◀ PREV button

Press to move back through titles, chapters or tracks on a disc.

3) ◀◀ / ▶▶ SEARCH buttons

◀◀ SEARCH: Fast reverse playback.

▶▶ SEARCH: Fast forward playback.

4) GOTO button

Press to skip directly to a location on a DVD.

5) Cursor (▼, ▲, ◀, ▶) buttons

Press to highlights selections on a menu screen and adjust certain settings.

ENTER button

Press to confirm selections on a menu screen.

6) MEMORY button

In DVD play mode, enter the number of a selected titles or chapters.

7) Number (0 - 9) buttons

Use when creating programs and locating a title/chapter/track or specific time.

8) REPEAT A-B button

Press to perform point-to-point repeat playback on a DVD or CD.

REPEAT DISC button

Press to repeat a DVD chapter or title.
Press to repeat a CD track or the entire disc.

SETUP button

When a DVD is stopped, brings up the unit's SETUP menu.

9) MENU button

Press to enter and exit the main DVD menu.

10) ▶▶ NEXT button

Press to move forward through titles, chapters or tracks on a disc.

11) ■ STOP button

Press to stop playing a disc.

▶ PLAY button

Press to start or resume playback of a disc.

■ PAUSE button

Press to pause playback and frame advance.

12) DISPLAY button

Press to show status information on the screen.

13) ANGLE button

Press to switch the camera angle of the video presentation when scenes with multiple camera angles are recorded on a DVD.

14) AUDIO button

Press to select audio soundtracks of a DVD or change output mode of a CD.

15) SUBTITLE button

Press to select one of the subtitle languages programmed on a DVD (if available).

RETURN button

Press to return to normal operation after using the SETUP menu of a DVD.

Unit Reference Guide

UNIT A (with green stripe on the front unit)

UNIT B (with blue stripe on the front unit)

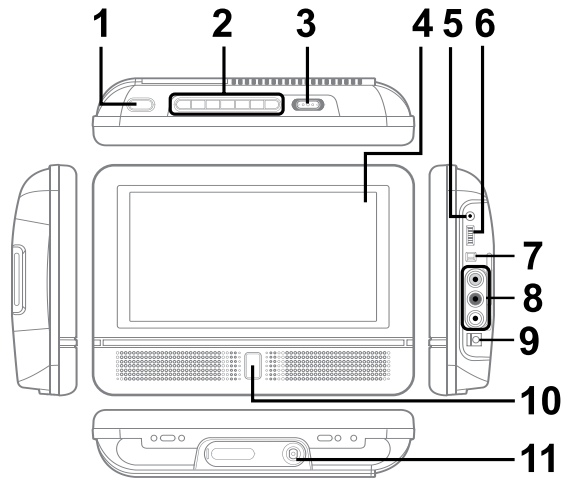

EN

- 1) ▲ button**
Press the button and hold the front panel to open the disc door.
- 2) ◀◀ SEARCH button**
Press to perform fast reverse playback.
▶▶ SEARCH button
Press to perform fast forward playback.
◀◀ PREV button
Press to select previous chapters or tracks on a disc.
▶▶ NEXT button
Press to select next title, chapter or track on a disc.
■ STOP button
Press to stop playing a disc.
|| PAUSE button
Press to pause playback and frame advance.
▶ PLAY button
Starts or resumes playback of a disc.
- 3) STANDBY (power off) / ON switch**
- 4) LCD screen**
- 5) Headphone jack**
- 6) VOLUME control**
Adjusts the volume.
- 7) AV IN / DVD switch**
- 8) AUDIO IN/OUT / VIDEO IN/OUT jacks**
- 9) DC IN 9V-12V jack**
- 10) Remote sensor**
Receives the remote control signal.
POWER ON indicator
When the STANDBY / ON switch is in the ON position, the green light will illuminate.
- 11) Stand**

Power Supply

Using the car power adapter

The included 12V car power adapter is designed for use with vehicles that have a 12V, negative ground electrical system.

Using unit A and B together

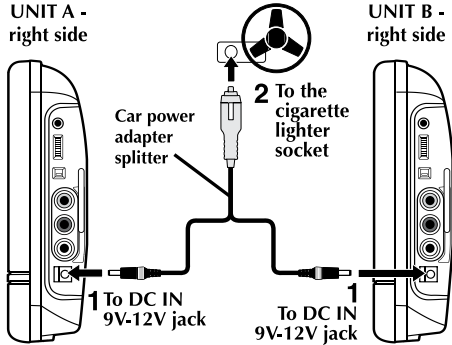

Using one unit only

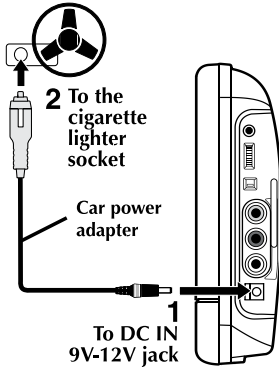

<p>Fuse replacement instructions</p> <p>Press and hold ↓</p> <p>Press and hold ↑</p> <p>Fuse</p>	<p>Caution</p> <p>For continued protection against risk of fire, replace only with same type and rating of fuse.</p>
---	---

IMPORTANT
This car adapter is for use with 12 volt batteries only.

WARNING:
Disconnect this car power adapter when not in use. Not for use in 24V vehicles.

Caution:

- Use this unit only with the included 12V car power adapter. Use with other car adapters could damage the unit, or even your vehicle.
- The included 12V car power adapter is for use with this unit only. Do not use it with any other equipment.
- In the interest of traffic safety, drivers should not operate the unit or view videos while driving.
- When the inside of the 12V car socket is dirty with ashes or dust, the power section may become hot due to poor contact. Be sure to clean the 12V car socket before use.
- After use, disconnect the 12V car power adapter from both the unit and cigarette lighter socket.
- If the unit is not properly attached to a vehicle, it may become airborne in the event of an accident and cause damage, injury, or death.
- Check your local traffic laws for rules governing the use of video devices in vehicles.

Using the AC power adapter

The included AC power adapter operates on AC between 100V-120V.

- The supplied AC power adapter is suitable for use on AC mains supplies of 100-120 Volts AC and should only be connected to a mains supply within these parameters.

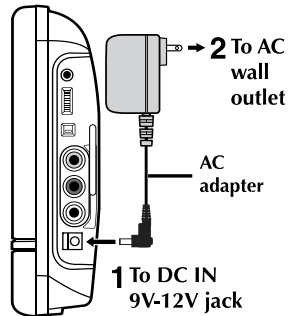

Caution:

- Turn off the unit before unplugging the AC power adapter to avoid damage to the unit.
- When the unit is not going to be used for a long time, disconnect the AC power adapter from the AC outlet.
- The AC power adapter included with this unit is for its use only. Do not use it with other equipment.

IMPORTANT

- Be sure to use the unit close to the wall outlet and make it easily accessible. If a malfunction occurs, disconnect the plug from the wall outlet at once.
- When the AC power adapter is plugged in, the apparatus is not completely disconnected from the main power source, even when the unit is turned off.

Connections

Connecting unit to a TV

If your TV has Audio/Video inputs, you can connect the unit to your TV using Audio/Video cable.

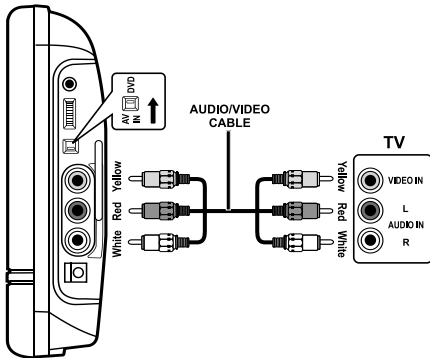

Listening to a stereo receiver or amplifier on unit

The unit can play two channels Dolby Digital.

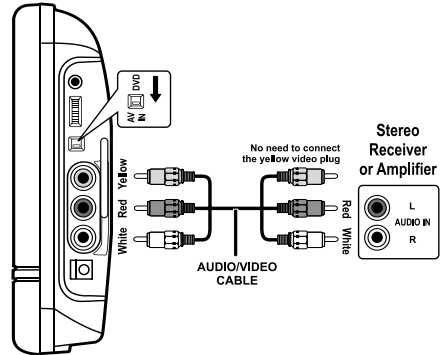

EN

Watching a DVD on your TV

1. Connect your TV to the unit using an Audio/Video cable.
2. Turn on unit. Slide the DVD/AV IN switch to DVD.
3. Turn on the TV and follow the instructions included with it to play the DVD.

Note:

- Make sure to use the correct Audio/Video cable. Connecting the plugs incorrectly may cause a weak signal.
- If your TV does not have Audio/Video inputs, you will need to purchase an RF modulator (sold separately) and follow the instructions included with it to connect the unit to your TV.



Listening external audio equipment

1. Connect the unit to the left/right Audio In jacks on the other equipment using an Audio/Video cable.
2. Turn on unit. Slide the DVD/AV IN switch to AV IN.
3. Turn on your audio equipment and follow the instructions provided with it to select the AUDIO IN function.

Note:

- Make sure to use the correct Audio cable. Connecting the plugs incorrectly may cause a weak signal.
- If you have a stereo VCR, make sure you set it to stereo mode.
- Due to copyright protection, DVD movies cannot be copied. If you copy a DVD movie onto a videotape, the resulting copy will be unclear, with poor sound quality. This is NOT caused by a defective DVD system.



Playing a game systems/video equipment on unit

You can connect game systems or other video equipment for playback through unit.

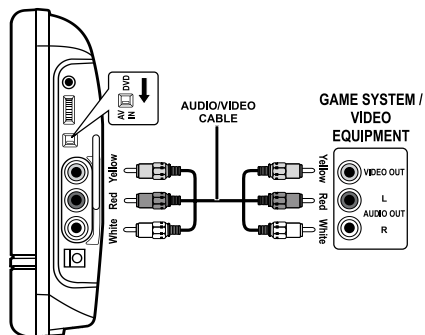

Watching video equipment

1. Connect the other equipment to the unit using an A/V Cable.
2. Turn on the unit. Slide the DVD/AV IN switch to AV IN.
3. Turn on the video equipment and follow the instructions provided with it to playback.

Note:

- Make sure to use the correct Audio/Video cable. Connecting the plugs incorrectly may cause a weak signal.
- If you have a mono VCR, the volume level from the speakers will be low.



Playing a DVD on unit A and B

You can watch the same DVD on unit A and B.

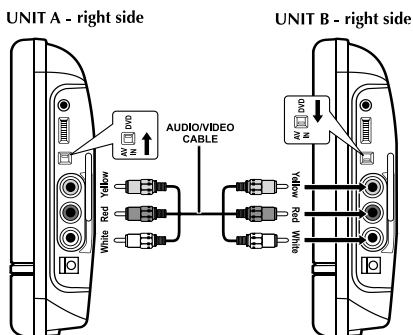

Watching a DVD on unit A and B

1. Connect the unit A and B using the included Audio/Video cable.
2. Turn on unit A and B. Slide the DVD/AV IN switch on unit A(B), then slide the DVD/AV IN switch on unit A(B) to AV IN.
3. Play a DVD on unit A(B); the other unit will play at the same time.

Using headphones/earphones

Turn down the volume before connecting the headphones/earphones. Slowly raise the volume with the headphones on until you reach your desired volume. When headphones are connected, the speaker is automatically disabled.

Caution:

Avoid listening to sound at excessive levels which could be harmful to your ears.

Placement

Mounting in the vehicle

Use the supplied mounting straps to install the units on the back of the vehicle's headrests. Tightly wrap the mounting strap around the headrest.

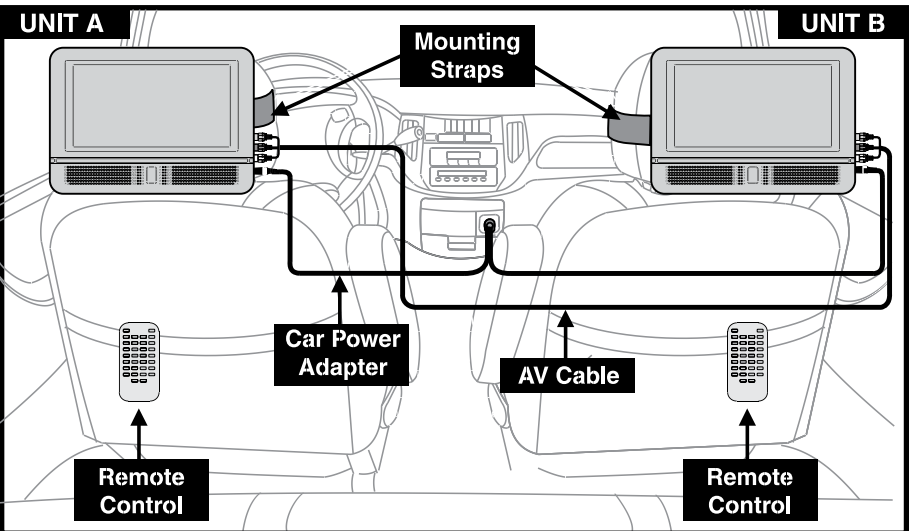
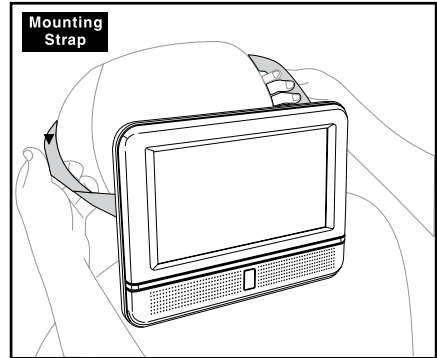
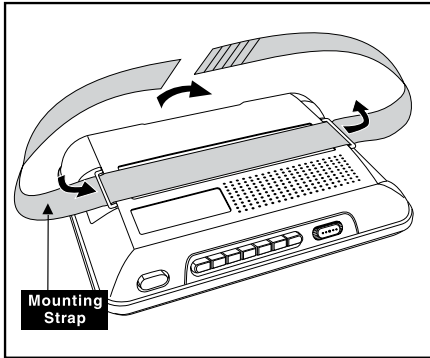

SAFETY WARNING!

- This unit should never be used by the vehicle's driver or left unsecured in the vehicle while driving.
- If this unit is being used in your vehicle, be sure that it is secured or held safely, and does not obstruct any safety device, including air bags or seat belts.
- All passengers should wear seat belts when using this unit in a moving vehicle.
- If in doubt, please contact your vehicle manufacturer for further advice.

Using the stand

You can stand the units up on a desk or table using the stand on the back.

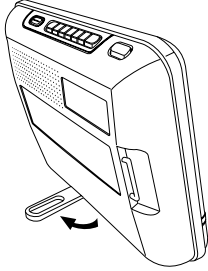

EN

Unit Operation

Turning the unit on

- 1) Slide the STANDBY/ON switch on the top of the both units to the "ON" position.
- 2) Slide the AV IN / DVD switch of unit to DVD. The logo (start-up picture) will appear on the screen.



Note:

- When the unit is not going to be used for a long time, disconnect the AC power adapter from AC outlet.



Playing Discs - Basic Functions

Compatible discs

- DVD, DVD-R, DVD-RW
- CD, CD-R, CD-RW

Compatible formats



- DVD, JPEG, CD

Regional coding



Your unit has been designed to process regional management information stored on DVD discs. The regional code for your unit is 1. Discs that have a different regional code will not be played.

Basic playback operations



Playback



1. Slide the STANDBY/ON switch to the ON position. Slide the AV IN / DVD switch on unit to DVD.
See **CUSTOMIZING THE DVD FUNCTION SETTINGS** before proceeding to step 2.
2. Press the  button and hold the front panel to open the disc door.
3. Hold the disc by its edge and gently push it onto the spindle, with the label side facing the front, until you hear a "click".
4. Push the disc door gently to close it. It takes a short while for your unit to load the disc. After loading, for most DVDs, the unit will automatically take you main menu or start playing. If the unit does not automatically start playing the DVD, press the  PLAY button.

Pausing playback (still mode)



Press the  PAUSE button. To resume normal playback, press the  PLAY button. Each time you press the  PAUSE button, the picture advances one frame.

Stopping playback

Press the  STOP button at the location where you want to interrupt playback. To resume playback at the position where the disc was stopped, press the  PLAY button.

If you press the  STOP button twice, the unit's memory will be cleared and pressing the  PLAY button will reset the disc to the beginning.

Skipping to a different track

- Press the  PREV button to go back to previous chapters/tracks.
- Press the  NEXT button to advance chapters/tracks.
- For an audio CD, use the number buttons on the remote control to go directly to the desired track number.

Audio selection (DVD)

On some discs, the sound is recorded in two or more formats. Follow the directions below to select the type of playback.

1. While a disc is playing, press the AUDIO button to show the current audio format number.
2. Press the AUDIO button repeatedly to select the desired audio format.

Note:

- If only one audio format is recorded, the number does not change.
- About two seconds later, playback continues in the new audio format.



Subtitle selection (DVD)

1. While a DVD is playing, press the SUBTITLE button to display the current language setting.
2. Press the SUBTITLE button repeatedly to select the desired subtitle language.

Note:

- If only one language is recorded, the language does not change.
- About two seconds later, playback continues with the new subtitle selected.
- The number of languages recorded differs depending on the disc.
- If no button is pressed within a few seconds, playback continues without changing the current subtitle.
- This function can only be used for discs on which subtitles have been recorded in multiple languages.
- On some DVDs, subtitles are activated from the main menu of the DVD. Press the MENU button to activate the main menu.



Angle selection (DVD)

Some DVDs contain scenes that have been shot from a number of different angles. For these discs, the same scene can be viewed from each of these different angles.

1. While you are playing a DVD with different angles recorded, press the ANGLE button to view the number of current angles available.
2. Press the ANGLE button repeatedly to change the scene to the next angle in those recorded.
 - About two seconds later, playback continues from the new angle selected.

- If no button is pressed within 10 seconds, playback continues without changing the current angle.

Note:

- This function can only be used for discs on which scenes shot from multiple angles have been recorded.
- If only one angle is recorded, "  " is displayed.



Special Functions

Display function (DVD)

While the disc is playing, press the DISPLAY button repeatedly to display information on operation status:

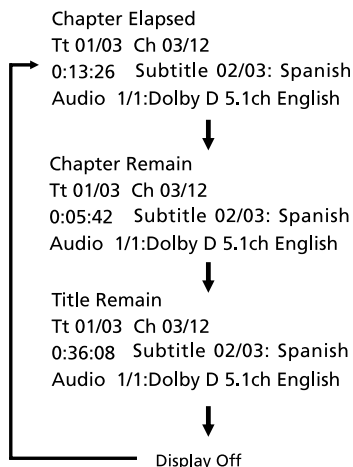

Note:

- Many discs only have one title.



Locating a specific chapter / track

If you know the chapter / track number you want to play, you can locate a specific chapter / track by directly selecting a chapter / track number.

1. Press the GOTO button to search for your desired chapter / track.
2. Press the ◀ or ▶ button to highlight a chapter / track then press the corresponding number button(s) for the chapter /track you want.
3. Press the ENTER button to confirm. Playback starts from the selected chapter / track.

Locating a specific time

You can move to a specific location by entering its corresponding time (hours, minutes, seconds)

1. Press the GOTO button twice.
2. Press the corresponding number buttons for the setting point you want.
3. Press the ENTER button to confirm. Playback starts from the selected location.

Locating a specific title (DVD)

If a DVD contains title numbers, you can locate a specific title by directly selecting a title number.

1. In STOP mode, press the GOTO button.
2. Press the ◀ or ▶ button to highlight a specific field and press the corresponding number button(s) for the title you want.
3. Press the ENTER button to confirm. Playback starts from the selected title.

Note:

- Some discs may not respond to this process.
- Some scenes may not be located as precisely as specified.
- This method for accessing specific locations is available only within the current title of the DVD.



Repeat Playback

You can play a specific title or chapter repeatedly. (Chapter repeat, title repeat, A-B repeat)

Repeating a chapter (DVD)

You can play the same chapter repeatedly.

1. While the disc is playing, press the REPEAT DISC button until the "Chapter" indicator displays on the screen. The current chapter is played repeatedly.

Repeating a title

You can play the same title repeatedly.

2. While the disc is playing, press the REPEAT DISC button until the "Title" indicator displays on the screen. The current title is played repeatedly.

To resume normal playback

3. While the disc is playing, press the REPEAT DISC button until the "Repeat Off" indicator displays on the screen.

You can play a single track or an entire disc repeatedly.

Repeating a single track (CD)

You can play the same track repeatedly.

1. While the disc is playing, press the REPEAT DISC button until the "Repeat One" indicator displays on the screen. The current track is played repeatedly.

Repeating an entire disc

2. While the disc is playing, press the REPEAT DISC button until the "Repeat All" indicator

displays on the screen. The entire disc is played repeatedly.

To resume normal playback

3. Press the REPEAT DISC button until the "Repeat Off" indicator displays on the screen.

Repeating a specific section (DVD/CD)

You can play a specific section repeatedly.

1. While the disc is playing, press the REPEAT A-B button at the beginning of the section (A is displayed) you want to play repeatedly.
2. Press the REPEAT A-B button again at the end of the section (AB is displayed) you want to play repeatedly.
3. The unit will immediately begin replaying your selection.

To resume normal playback

4. While the disc is playing, press the REPEAT A-B button until the "AB OFF" indicator displays on the screen.

Note:

- A-B repeat can only be used within the same title. If the start and end of the section to be repeated are in different titles, A-B repeat is cancelled.
- The A-B repeat function does not operate in scenes where different camera angles are recorded.



Playing JPEG Files

This unit can play JPEG files recorded on CD-R and CD-RW discs.

Playing a JPEG file disc

1. Press the button and hold the front panel to open the disc door.
2. Hold the disc by its edge and gently push it onto the spindle, with the label side facing the front, until you hear a "click".
3. Push the disc door gently to close it.
4. The unit will take a short while to load the disc, then automatically begin playback. The JPEG files will be playback one by one.
5. Press the STOP button to go to the folder list.

6. Press the ▲ or ▼ button to highlight a file to play. Press the ► PLAY button to start playback.

Note:

- You can press the PAUSE button to interrupt playback, and press the ► PLAY button to resume playback.
- You also can use the GOTO function or use the numbered buttons to enter the image number to quickly select any image.
- Press the ANGLE button on the remote control to rotate the picture orientation by 90°.



DVD Programmable Playback

Programmable memory

The programmed playback provided by this unit is title/chapter programmed playback.

Title/Chapter programmed playback

1. Press the MEMORY button in PLAY mode.
2. Input the title (2 digits) and chapter (2 digits)

by pressing the number buttons. (For example : 01 02, 02 05, 02 11.) It will move to the next item automatically.

3. Repeat steps 2 to add additional titles and chapters.
4. Press the ► PLAY button to start the programmed playback.

EN

Customizing the DVD Function Settings

Language setup

1. In STOP mode, press the SETUP button.
2. Use the ▲ or ▼ button to select the option (OSD Language, Audio, Subtitle or Disc Menu), then press the ► button.
3. Use the ▲ or ▼ button to select your preferred language, then press the ENTER button to confirm.
4. Press the ◀ button to go back to the previous menu. Repeat steps 2 and 3 to adjust other options.
5. To exit the SETUP MENU and return to the normal screen, press the RETURN or SETUP button.

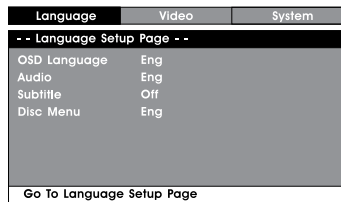

Video setup

1. In STOP mode, press the SETUP button.
2. Press the ◀ or ► button repeatedly until VIDEO SETUP appears.
3. Use the ▲ or ▼ button to select the option (Brightness or Contrast), then press the ► button. Use the ◀ or ► button to make adjustments, then press the ENTER button (The screen will change to your selected setting).
4. Repeat steps 2 and 3 above to adjust other options.
5. To exit the SETUP MENU and return to the normal screen, press the RETURN or SETUP button.

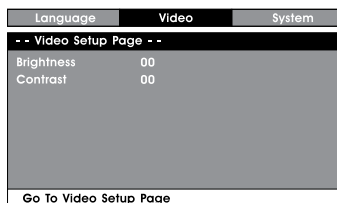

Note:

- Some DVDs may not play in the audio language selected. A prior language may be programmed on the disc.
- Some DVDs may be set to display subtitles in a language other than the one selected. A prior subtitle language may be programmed on the disc.
- Some DVDs allow you to change subtitle selections via the disc menu only. If this is the case, press the MENU button and choose the appropriate subtitle from the selection on the disc menu.
- Some DVDs may not include your pre-selected language. In this case, the DVD player automatically displays disc menus consistent with the disc's initial language setting.



System setup

1. In STOP mode, press the SETUP button.
2. Press the ◀ or ▶ button repeatedly until SYSTEM SETUP appears.
3. Use the ▲ or ▼ button to select the option (Tv Display or Default), then press the ▶ button. Use the ▲ or ▼ button to make adjustments, then press the ENTER button (The screen will change to your selected setting).
4. Repeat steps 2 and 3 above to adjust other options.
5. To exit the SETUP MENU and return to the normal screen, press the RETURN or SETUP button.

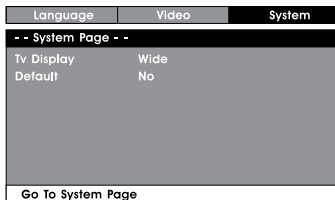

Tv display

Pan Scan

- When wide-screen video is played, this mode clips the right and left sides of the image so that it can be viewed on a conventional screen.
- Some wide-screen DVDs that do not permit Pan Scan mode playback are automatically played in letterbox mode (black bands that appear at the top and bottom of the screen).

Cut off when a wide-screen video image is played.



PAN SCAN



LETTER BOX



WIDE SCREEN

Letter Box

- When wide-screen video is played in this mode on a conventional screen, black bands appear at the top and bottom of the screen.

Wide screen

- This is the correct mode for playing wide-screen videos on the unit or other external wide-screens.

Note:



- The displayable picture size is preset on the DVD. Therefore the playback picture of some DVDs may not conform to the picture size you select.
- When you play DVDs recorded in the 4:3 aspect ratio, the playback picture will always appear in the 4:3 aspect ratio regardless of the TV TYPE setting.

Default

It takes 3-5 seconds to reset the DVD settings to the factory default.

Additional Information

Troubleshooting

The unit does not switch on.

- Make sure it is plugged in.
- Turn on the unit.

EN

The device switches off spontaneously.

- The device switches off automatically when it is in STOP mode for more than 30 minutes without any user intervention. Switch it on again.
- It might be impossible to read the disc.
- Insert the disc with the printed side facing up.
- Make sure disc can actually be played by this device.
- Make sure disc's regional code matches the unit's regional code. This unit's regional code is 1.
- Clean the disc.

There is no picture.

- Make sure you have switched on the TV set.
- Check the connections.
- Select the AV input/output assigned to unit on the TV.

The picture is of poor quality (with snow or lines).

- Check the connections.

There is no sound or the sound is of poor quality.

- Check the connections.

I can't find my file in the JPEG listing.

- Make sure the filename is valid.

The remote control does not work or works only intermittently.

- Make sure batteries are inserted or change them.
- Aim the remote control at the unit. The infrared beam must not be blocked or interrupted.
- Make sure the remote control is configured to control the device you are trying to operate with it.

The subtitles do not appear.

- Make sure the DVD provides subtitles.
- Refer to the section on how to display subtitles.

The disc menu language is not the correct one.

- The disc menu language has not been set up.
- The language of your choice is not available on the disc.

Compatible Formats

In order to ensure playback, discs must conform with DVD and CD standards. This unit may not play some recordings or files due to differences in recording formats, software used and disc types.

DVD-Video

Digital video discs - 12 cm, single or double sided, single or dual layer. DVDs are high density optical discs on which high quality picture and audio are recorded by means of digital signals.



DVD-R, DVD-RW

Most DVD-R (one recording only) and DVD-RW discs (rewritable), depending on the DVD writer and discs used. Recordings using DVD-R and DVD-RW discs must be made in Video DVD mode.



Audio CDs

Audio CDs (12 cm).



CD-R, CD-RW

Most CD-R (one recording only) and CD-RW discs (rewritable).



CD-Rs written during a multisession recording can be played, provided that the session has ended before the disc is played (depending on the write software).

However, depending on the condition of the CD-writer, computer and the disc used, you may find that not all discs will play. When playing a CD-R disc, it is normal for the unit to take up to 20 seconds to recognize the disc before starting to play.

If the disc is not recognized after a period of 20 seconds, remove the disc, and insert it again.

- Do not use its full capacity.
- CD-Rs should be preferably used instead of CD-RWs (rewritable CDs) as, in certain cases, CD-RW playback may be faulty.
- Use reliable, good-quality CD writing software.
- Close all other applications on the computer to ensure reliable CD-R disc recording.

Jpeg files

CD-R and CD-RW with JPEG files. Certain JPEG files, including progressive JPEG files, cannot be read by this unit.

The total number of files and folders on the disc should be less than 650. Make sure that files have the ".jpg" extension. Files without the ".jpg" extension will not be able to be read by the unit — even though the files are shown as JPEG images on your computer.

Notes on copyright

It is forbidden by law to copy, broadcast, show, broadcast on cable, play in public, or rent copyrighted material without permission.

Apparatus Claims of U.S. Patent Nos. 6,836,549; 6,381,747; 7,050,698; 6,516,132; and 5,583,936 licensed for limited viewing uses only.

This product incorporates copyright protection technology that is protected by U.S. patents and other intellectual property rights. Use of this copyright protection technology must be authorized by Macrovision, and is intended for home and other limited viewing uses only unless otherwise authorized by Macrovision. Reverse engineering or disassembly is prohibited.

Caution:

This unit is designed and manufactured to respond to the Region Management Information. If the Region number of a DVD does not correspond to the Region number of this DVD player, this player cannot play the disc. The Region number for this DVD player is Region 1.

Sound Systems

Dolby Digital

Dolby Digital is a technology developed by Dolby Laboratories. Soundtracks encoded in Dolby Digital can reproduce from one to 5.1 discrete channels of excellent quality audio.

The unit automatically recognizes the Dolby Digital bitstream and provides a downmix suitable for two-channel listening. An additional Dolby Digital decoder is required for reproduction of the discrete multi-channel soundtracks available on many DVDs.



Manufactured under license from Dolby Laboratories. 'Dolby' and the double-D symbol are trademarks of Dolby Laboratories.

Precautions

Use

- If your unit has been stored in a cool place for any length of time during a journey for example, wait for about 2 hours before using it.
- During thunderstorms, we recommend that you isolate the unit from the electrical supply so that it is not damaged by electrical or electromagnetic surges.
- This unit is designed for continuous use. Switching off the unit to standby mode does not disconnect it from the mains supply. To completely isolate the equipment, remove the plug from the power outlet as some components remain connected to the electrical supply.
- If you notice any burning or smoke, disconnect the unit immediately to avoid any risk of electrocution.
- Do not attempt to look inside the unit through the disk tray opening or any other opening. You may be electrocuted or exposed to laser radiation.
- This unit is for domestic use only and must not be used for industrial purposes.
- Total or partial copying of recordings protected by copyright legislation, without the explicit permission of the holder of the rights, contravenes current legislation. Copying or downloading music files for sale or any other business purpose constitutes or could constitute a violation of copyright law.

Cleaning

- Use a soft, dry, clean cloth. Regularly dust the vents at the back or sides.
- Using solvents, abrasive or alcohol-based products risk damaging the unit.
- If an object or liquid enters inside the unit, unplug it immediately and have it checked by an authorized servicer or service center.

Handling and caring for discs

- Handle your discs with care. Hold the disc with your fingers at the edges or through the hole.
- Insert the disc with the label facing up (for a single-sided disc).
- Place the disc properly into the tray in the allotted holder.
- Use a soft cloth to clean discs if necessary, always wiping from the center to the edge.
- Always put discs back in their cases after use and store in a vertical position.
- Do not close the tray with two discs in it or with a disc not sitting correctly in the holder.
- Do not play cracked, chipped or warped discs nor try to repair them with adhesive tape or glue.
- Do not write on a disc.
- Do not move the unit when a disc is being played.
- Do not scratch discs or store them in places exposed to direct sunlight, high humidity or high temperatures.
- Do not use aerosol cleaners, benzene, anti-static liquids or any other solvent for cleaning discs. When cleaning, wipe gently with a soft damp (water only) cloth from the center to the edge, avoiding circular motions, which could cause scratches and interference during playback.

Limited Warranty

EN

AVC MULTIMEDIA (“AVC”) makes the following limited warranty. This limited warranty extend to the original consumer purchaser and is limited to non-commercial use of the product.

One Year Parts & Labor Warranty

AVC products purchased in the United States are warranted to be free from defects in materials or workmanship for a period of one year from the date of their original retail purchase. If the unit fails to conform to this warranty, we will service the product using new or refurbished parts and products, at **AVC's** sole discretion.

During a period of one year from the effective warranty date, **AVC** will provide, when needed, service labor to repair a manufacturing defect at its designated Service Center. To obtain warranty service in the United States, you must first call our **Customer Support Center at 1-800-506-5746 or 1-877-252-6873, during the hours listed in the box below.** The determination of service will be made by AVC Customer Support. **PLEASE DO NOT RETURN YOUR UNIT TO AVC WITHOUT PRIOR AUTHORIZATION.** New or remanufactured replacements for defective parts or products will be used for repairs by AVC at its designated Service Center for one year from the effective warranty date. Such replacement parts or products are warranted for an additional one year from the date of repair or replacement. The Customer will be required to ship the unit to the Service Center indicated at the time Customer Support is contacted to make the necessary repairs. The customer is responsible for all transportation charges to the service facility.

Packaging and Shipping Instruction

When you send the product to the **AVC** service facility you must use the original carton box and packing material or an equivalent as designated by **AVC.**

LIMITED WARRANTY

Your Responsibility

- (1) You must retain the original sale receipt to provide proof of purchase.
- (2) These warranties are effective only if the product is purchased and operated in the U.S.A. or Canada.
- (3) Warranties extend only to defects in material or workmanship, and do not extend to any product or parts which have been lost or discarded, or damage to product or parts caused by misuse, accident, improper operation or maintenance, or use in violation of instructions provided with the product, or to product which has been altered or modified without authorization of **AVC,** or to products or parts thereof which have had the serial number removed or changed.

Out of Warranty

In the event your product requires repair after the limited warranty period has expired, please contact our Customer Support Center at **1-800-506-5746, 1-877-252-6873 or www.1800customersupport.com/RCA**
Hours: Monday–Thursday: 9am–7pm, Friday: 9am–5pm, Saturday: 9am–NOON Eastern time.
Important: You are responsible for any transportation, shipping or insurance relative to the return of product to our Product Returns Center.

All warranties implied by state law, including the implied warranties of merchantability and fitness for a particular purpose, are expressly limited to the duration of the limited warranties set forth above. With the exception of any warranties implied by state law as hereby limited, the foregoing warranty is exclusive and in lieu of all other warranties, guarantees, agreements and similar obligations of manufacturer or seller with respect to the repair or replacement of any parts. In no event shall **AVC** be liable for consequential or incidental damages.

No person, agent, distributor, dealer or company is authorized to change, modify or extend the terms of these warranties in any manner whatsoever. The time within action must be commenced to enforce any obligation of **AVC** arising under the warranty or under any statute, or law of the United States or any state thereof, is hereby limited to one year from the date of purchase. This limitation does not apply to implied warranties arising under state law.

This warranty gives you specific legal rights and you may also have other rights, which may vary, from state to state. Some states do not allow limitation on how long an implied warranty lasts, when an action may be brought, or the exclusion or limitation of incidental or consequential damages, so the above provisions may not apply to you.

For more information on other products and services, please visit our web site at

www.1800customersupport.com/RCA

Important: Also keep your “Bill of Sale” as proof of purchase.

Model no. Product name

Type of set

Serial no. Invoice no.

Date purchased Dealer name

FOR SERVICE AND REPAIR, PLEASE VISIT **www.1800customersupport.com/RCA**

Specifications and external appearance are subject to change without notice.
Download from www.Sonmanuals.com. All Manuals Search And Download.

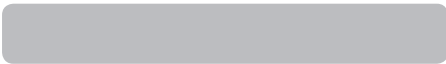

IMPORTER
AVC Multimedia
Markham, Ontario L3R 1E3

© 2008 AVC Multimedia
<http://www.1800customersupport.com/RCA>
Printed in China
811-728191W011

Free Manuals Download Website

<http://myh66.com>

<http://usermanuals.us>

<http://www.somanuals.com>

<http://www.4manuals.cc>

<http://www.manual-lib.com>

<http://www.404manual.com>

<http://www.luxmanual.com>

<http://aubethermostatmanual.com>

Golf course search by state

<http://golfingnear.com>

Email search by domain

<http://emailbydomain.com>

Auto manuals search

<http://auto.somanuals.com>

TV manuals search

<http://tv.somanuals.com>