



digital video disc player
the ultimate movie experience!

RCA
user's manual
RC5220P



CAUTION

RISK OF ELECTRIC SHOCK
DO NOT OPEN

TO REDUCE THE RISK OF ELECTRIC SHOCK, DO NOT REMOVE THE COVER (OR BACK). NO USER-SERVICEABLE PARTS ARE INSIDE. REFER SERVICING TO QUALIFIED SERVICE PERSONNEL.

This symbol indicates "dangerous voltage" inside the product that presents a risk of electric shock or personal injury.

This symbol indicates important instructions accompanying the product.

CAUTION: DVD PLAYERS USE A VISIBLE LASER BEAM WHICH COULD CAUSE HAZARDOUS RADIATION EXPOSURE IF DIRECTED. BE SURE TO OPERATE THE PLAYER CORRECTLY AS INSTRUCTED.

CAUTIONS

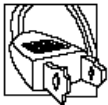

Caution: To prevent electric shock, match wide blade of plug to wide slot, fully insert.

Attention: Pour éviter les chocs électriques, introduire la lame la plus large de la fiche dans la borne correspondante de la prise et pousser jusqu'au fond.

This product satisfies FCC regulations when shielded cables and connectors are used to connect the unit to other equipment. To prevent electromagnetic interference with electric appliances, such as radios and televisions, use shielded cables and connectors for connections.

FCC NOTE (for U.S.A.):

This equipment has been tested and found to comply with the limits for a Class B digital device, pursuant to Part 15 of the FCC rules. These limits are designed to provide reasonable protection against harmful interference in a residential installation. This equipment generates, uses and can radiate radio frequency energy and, if not installed and used in accordance with the instructions, may cause harmful interference to radio communications. However, there is no guarantee that interference will not occur in a particular installation. If this equipment does cause harmful interference to radio or television reception, which can be determined by turning the equipment off and on, the user is encouraged to try to correct the interference by one or more of the following measures.

- Reorient or relocate the receiving antenna.
- Increase the separation between the equipment and receiver.
- Connect this equipment into an outlet on a circuit different from that to which the receiver is connected.
- Consult the dealer or an experienced radio/TV technician for help.

This class B digital apparatus meets all requirements of the Canadian Interference--Causing Equipment Regulations.

Product Registration

Please fill out the product registration card and return it immediately. Returning this card allows us to contact you if needed.

Keep your sales receipt to obtain warranty parts and service and for proof of purchase. Attach it here and record the serial and model numbers in case you need them. The numbers are located on the back of the player.

Model No. **RC5220P** _____

Serial No. _____

Purchase Date: _____

Dealer/Address/Phone: _____

WARNING

To reduce the risk of fire or shock hazard, do not expose this DVD player to rain or moisture.

CAUTION

THIS PRODUCT UTILIZES A LASER. USE OF CONTROLS OR ADJUSTMENTS OR PERFORMANCE OF PROCEDURES OTHER THAN THOSE SPECIFIED HEREIN MAY RESULT IN HAZARDOUS RADIATION EXPOSURE. DO NOT OPEN COVERS AND DO NOT REPAIR YOURSELF. REFER SERVICING TO QUALIFIED PERSONNEL.

CAUTION

FCC Regulations state that unauthorized changes or modifications to this equipment may void the user's authority to operate it. To assure compliance with FCC requirements, you must use the telephone line cord that is packed with this product. It is equipped with a special filter.

Note:

This unit can be used only where the power supply is AC 120 V, 50-60Hz. It cannot be used elsewhere.

Note:

This DVD player is designed and manufactured to respond to the Region Management Information. If the Region number of a DVD disc does not correspond to the Region number of this DVD player, this DVD player cannot play the disc. The Region number for this DVD player is Region No 1.

Note:

This device is protected by U.S. patent numbers 4,631,603 and 4,577,216 and 4,819,098 and other intellectual property rights. The use of Macrovision's copy protection technology in the device must be authorized by Macrovision and is intended for home and other limited pay-per-view uses only, unless otherwise authorized in writing by Macrovision. Reverse engineering or disassembly is prohibited.

**CLASS 1
LASER
PRODUCT**

Table of Contents

Setup & Connections 3

Unpack the Box	4
Install Batteries in the Remote	4
Important Battery Information	4
Types of Discs the Player Can Play	5
The Jacks on the Back of the DVD Player	6
Connection Options:	
DVD Player + TV with Audio/Video Input Jacks	7
DVD Player + TV without Audio/Video Input Jacks (Antenna Jack Only)	8
DVD Player + TV + VCR	9
DVD Player + TV + Dolby Pro Logic, Dolby Digital or DTS Receiver	10
Set the Menu Language	12
How to Find Your TV's Video Input Channel	13
Tour of the Remote Control	14
Component Buttons	14
Other Remote Control Buttons	15
Helpful Hints about the Remote	18

Playing Digital Video Discs 19

Loading and Playing a Disc	20
Using a Disc Menu	21
Disc Playback Features	22
Fast Motion Playback (Picture Scan)	22
Freeze Frame and Frame Advance	22
Slow Motion Playback (in Freeze Frame Mode)	23
Chapter Advance	23
Using the On-Screen Info Display	24
Selecting a Title	24
Selecting a Chapter	25
Using the Menu Icon	25
Selecting Different Play Modes	26
Using the Repeat Feature	27
Changing the Subtitle Language	29
Changing the Audio Language	30
Changing the Camera Angle	31
Using Bookmarks	31

Using the Features in the Menu System 33

Let's Talk About Navigation	34
How to use your Remote to Move through the Player's Menu System	34
The Play Menu Options	36
How to Create a Program	37
How to Delete or Edit a Program	37
Disc Guide	38
How to Use the Lock Menu	39
To Lock your DVD Player	39
To Unlock the Player	40
How to Change Your Password	41
Setting the Rating Limit	42
Using the Setup Menu	44
Language Prefs (preferences)	44
Changing the Audio Language Preference	45
Changing the Subtitle Language Preference	46
AutoPlay	47
Display	48
Sound	50
The System Test	52
Glossary	53

Playing CDs 55

Loading and Playing an Audio CD	56
Audio CD Playback Features	57
Using the Info Display	57
Selecting a Specific Track	58
Selecting a Play Mode	58
Repeat Play	62
Using IntroScan	64
Using the Clock	64
Using Bookmarks	65
The Play Menu Items	66
Dub Assist	67

Dolby Digital is a trademark of Dolby Laboratories
Licensing Corporation

DTS is a registered trademark of Digital Home Theater
Systems, Inc.

Table of Contents

Playing Video CDs 69

Loading and Playing a Video CD	70
Video CD Information Display	71
Video CD Playback Features	72
Skipping Tracks	72
Selecting a Specific Track	72
Selecting a Specific Index	72
Accessing the Disc Menu	72
Repeat Play	73
Changing the Audio Channel Output	74

Assistance 75

How to Resolve Product Performance Problems	76
Troubleshooting	76
Handling Cautions	79
Maintenance of Cabinet	79
Formation of Condensation	79
Handling Discs	79
Cleaning Discs	79
How to Resolve Product Performance Problems	80
Limited Warranty	80

Reference 83

Front Panel Controls	84
Front Panel Display	85
Programming the Remote	86
TV Codes	88
Accessories and Order Form	89
Index	91

Setup & Connections

Please Read This Section First

This section includes key information to get you started in the right direction. You'll get your DVD Player set up and connected. The rest of this User's Guide discusses the player's features and how to use them.

Section Overview:

- **Unpack the Box**
- **Types of Discs You Can Play**
- **The Jacks on the Back of Your DVD Player**
- **Connecting Your DVD Player**
 - **TV with Audio/Video Input Jacks**
 - **TV *without* Audio/Video Input Jacks (Antenna Jack only)**
 - **How to Connect a VCR**
 - **DVD Player + TV + Dolby Pro Logic or Dolby Digital or DTS Receiver**
- **A Tour of the Remote Control**

Dolby Digital is a trademark of Dolby Laboratories Licensing Corporation
DTS is a registered trademark of Digital Home Theater Systems, Inc.

A Note about the Illustrations

The illustrations in this book are representational, and in some instances may not exactly match the item represented.

Setup and Connections

Unpack the Box

Carefully unpack the items in the box:

- DVD player
- Remote control and batteries
- Audio/Video cables
- S-Video cable
- Power cord

Install Batteries in the Remote

1. Open the battery door on the back of the remote.
2. Insert fresh batteries. Make sure that the polarities (+ and -) are aligned correctly.
3. Replace the battery door.

Important Battery Information

- If you're not going to use the remote for a month or more, be sure to remove the batteries because they can leak and cause damage.
- Dispose of batteries in the proper manner, according to federal, state, and local regulations.
- Any battery may leak electrolyte if mixed with a different battery type, if inserted incorrectly, if all batteries are not replaced at the same time, if disposed of in fire, or if an attempt is made to charge a battery not intended to be recharged.
- Discard leaky batteries immediately. Leaking batteries can cause skin burns or other personal injury.

Types of Discs the Player Can Play

This DVD Player is capable of playing the following types of discs with the corresponding logos.



Digital Video Discs



Audio CDs

Protect Components from Power Surges

- Connect all components before plugging any power cords into the wall outlet.
- Always turn off the DVD Player, TV, and other components before you connect or disconnect any cables.

Position Cables Correctly to Avoid Audio Hum or Interference

- Insert all cable plugs firmly into their jacks.
- Place the audio/video cables to the sides of the TV's back panel instead of straight down the middle after you connect your components.
- Try not to coil any twin-lead cables and keep them away from the audio/video cables as much as possible.
- Make sure all antennas and cables are properly grounded.

DO NOT Use CD-R Discs!

The wavelength of the pickup of this DVD Player may cause CD-R discs to be erased. DO NOT play CD-R discs in this player!

CAUTION

Protect your components from overheating.

- Do not stack electronic components or other objects on top of the DVD Player.
- Do not block ventilation holes in any of the components. Arrange the components so that air can circulate freely.
- Allow adequate ventilation when placing your components in a stand.

See Safety Information on the inside front cover.

Setup and Connections

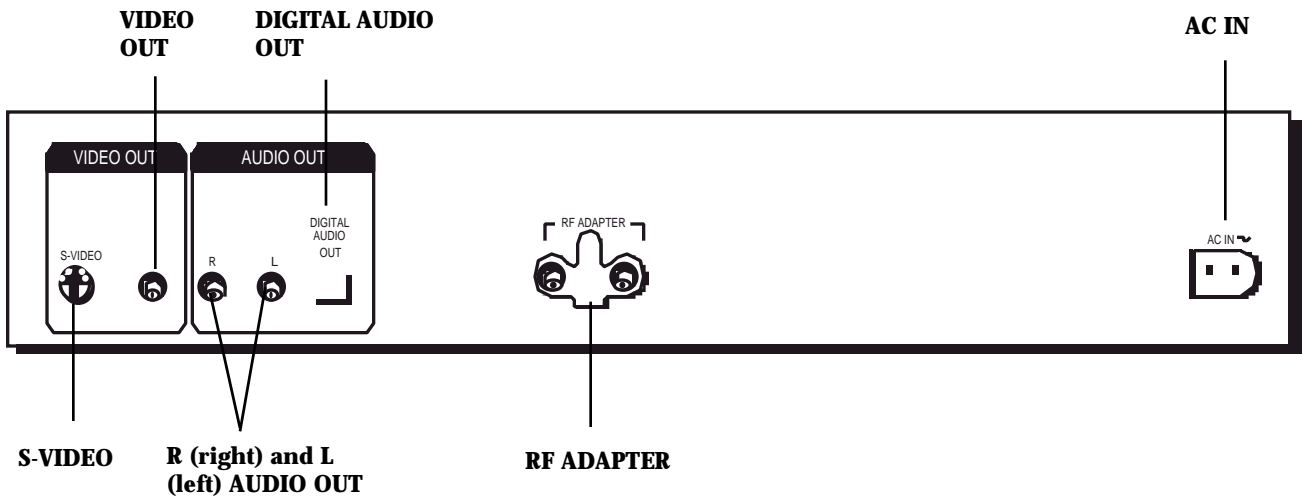

The Jacks on the Back of the DVD Player (listed alphabetically)

AC IN – Insert the AC power cord into the DVD Player and plug the other end into an AC outlet.

AUDIO OUT R and L – Insert audio cables (left and right) to these jacks on your DVD Player and to the corresponding Audio Input jacks (left and right) on your TV or receiver.

DIGITAL AUDIO OUT – Use a digital optical cable (not provided) to connect your DVD Player to a compatible Dolby Digital receiver or decoder. Dolby Digital offers theater-quality sound (six channels).

RF ADAPTER – Use coaxial cables to insert an RF Adapter (not provided) into this jack and to the Antenna Input Jack on your TV. An RF Adapter is needed if your TV doesn't have Audio/Video Input jacks. See p. 8 for connection instructions.

S-VIDEO – If your TV has an S-Video jack, you can connect an S-Video cable to your TV and to your DVD Player for increased video quality. The S-Video cable only carries the picture signal; remember to connect the left and right audio cables.

VIDEO OUT - Connect a video cable to this jack and to the Video Input jack on your TV.

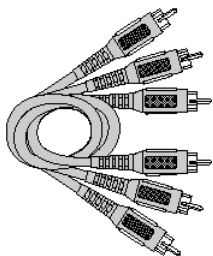

Important Information About the Pictures used in the Connections

The Audio/Video cables that came with your DVD Player are bundled together. For better visibility, we've shown each cable (audio left, audio right, and video) separately in the connections pictures that follow.

Setup and Connections

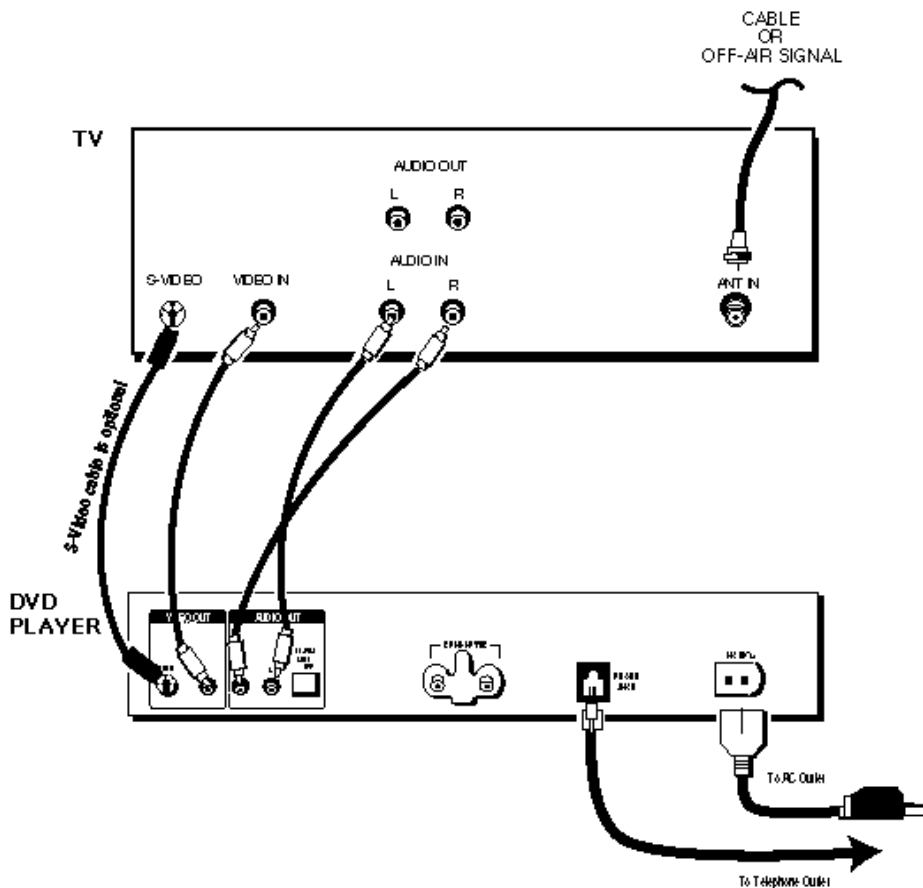

CAUTION

Do not stack electronic components or other objects on top of the DVD Player. See Safety Information on the inside front cover.

DVD Player + TV with Audio/Video Input Jacks

1. Connect the audio cables to the AUDIO OUT L (left – white) and R (right – red) jacks on the back of your DVD Player, and to the corresponding Audio Input jacks on your TV.
2. Connect the video cable (yellow) to the VIDEO OUT jack on the back of your DVD Player, and to the Video Input jack on your TV.
3. If your TV has an S-Video Input jack, connect the S-Video cable to the S-VIDEO OUT jack on the back of your DVD Player and to the S-Video jack on your TV. If your TV doesn't have an S-VIDEO jack, skip this step.
4. Connect the AC power cord to the AC IN jack on the back of your DVD Player, and plug the other end into an AC outlet.
5. Turn on your TV and tune it to the Video Input Channel. (If you don't know what channel is the Video Input Channel, please see page 13.)
6. Turn on your DVD Player.

Note:

Your cable or off-air connection to the television should not be affected by this connection. Connect your cable or off-air antenna to your television as you normally would. You may need to consult your television manual for details.

Setup and Connections

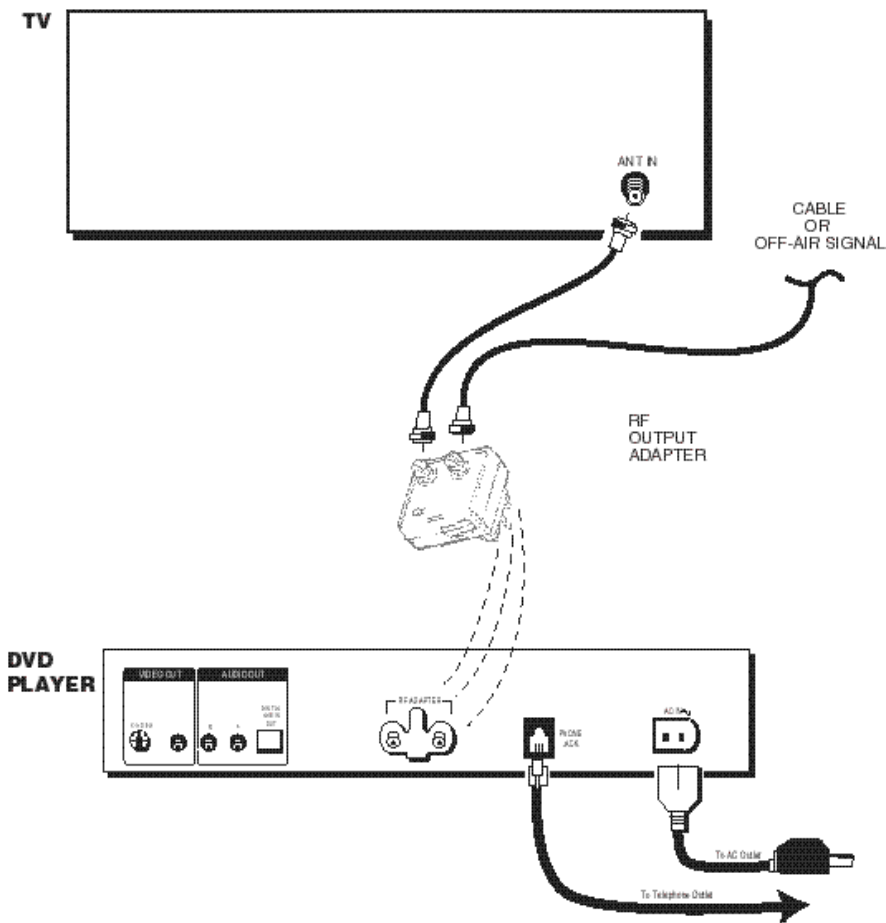

RF Output Adapter Required

You must buy an RF Output Adapter to use this connection. You can order your RF Output Adapter on page 89, or buy one at your local electronics store.



CAUTION

Do not stack electronic components or other objects on top of the DVD Player. See Safety Information on the inside front cover.

DVD Player + TV *without* Audio/Video Input Jacks (Antenna Jack Only)

1. Insert the RF output adapter into the RF ADAPTER jack on the back of your DVD Player.
2. Connect the coaxial cable from your cable or off-air signal to the Antenna Input jack on the RF output adapter.
3. Connect another coaxial cable to the Antenna Input jack on the back of your TV and to the RF output adapter.
4. Connect the AC power cord to the AC IN jack on the back of your DVD Player, and plug the other end into an AC outlet.
5. Turn on your TV.
6. Turn your TV to the RF Output Adapter's output channel (the adapter should have a CH 3/4 switch on it that indicates which channel to use on your TV.)
7. Turn on your DVD Player.

Setup and Connections

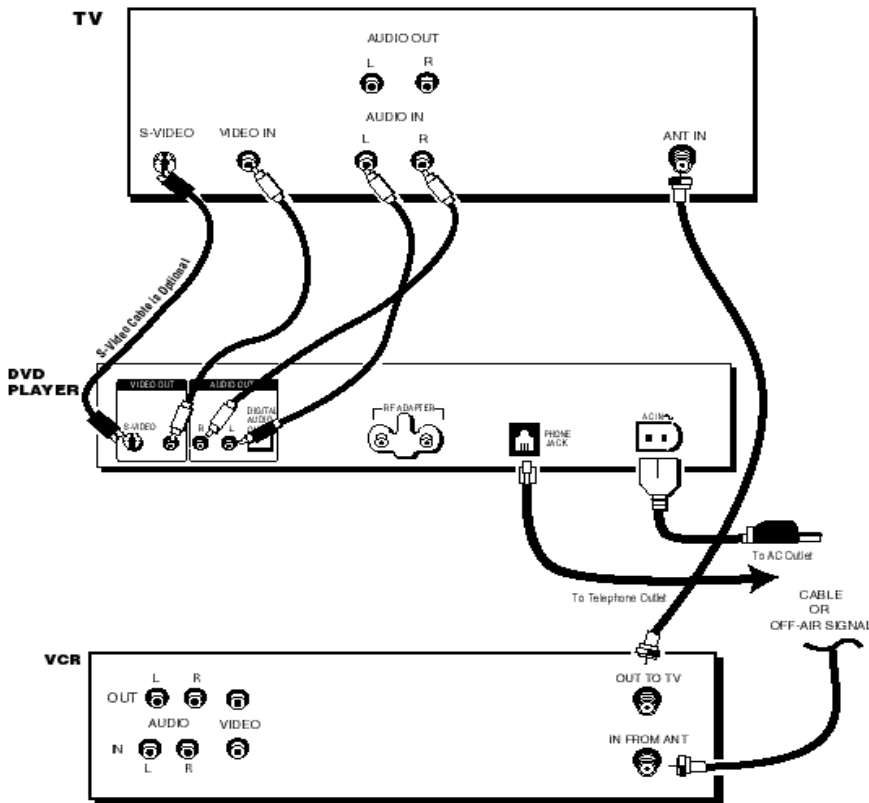

Don't Connect VCR directly to Your DVD Player

Many DVD discs are encoded with copy protection. Because of this, you should only connect your DVD Player directly to your TV, *not* to a VCR. Connecting to a VCR results in a distorted picture from copy-protected discs.

CAUTION

Do not stack electronic components or other objects on top of the DVD Player. See Safety Information on the inside front cover.

DVD Player + TV + VCR

1. Connect the audio cables to the AUDIO OUT L (left – white) and R (right – red) jacks on the back of your DVD Player, and to the corresponding Audio Input jacks on your TV.
2. Connect the video cable (yellow) to the VIDEO OUT jack on the back of your DVD Player, and to the Video Input jack on your TV.
3. If your TV has an S-Video Input jack, connect the S-Video cable to the S-VIDEO OUT jack on the back of your DVD Player and to the S-Video jack on your TV. If your TV doesn't have an S-VIDEO jack, skip this step.
4. Connect the antenna or cable to the Antenna Input jack on the VCR.
5. Connect a coaxial cable to the antenna output jack on the VCR and to the Antenna Input jack on the television.
6. Insert the AC power cord into the AC IN jack on the back of your player and into an AC outlet.
7. Turn on your television and tune it to the Video Input Channel. (If you don't know what channel is the Video Input Channel, please see p. 13).
8. Turn on your DVD Player.

To Watch the VCR

Tune your television to channel 3 or 4 depending on how you set the CH 3/4 switch on the back of the VCR.

Setup and Connections

DVD Player + TV + Dolby Pro Logic, Dolby Digital or DTS Receiver

To Connect the DVD Player

1. Connect the left and right audio cables to your audio/video receiver and to the AUDIO OUT L (left – white) and R (right – red) jacks on the back of your DVD Player.
2. If you have a Dolby Digital or DTS receiver, insert an optical digital cable (not provided) to the DIGITAL AUDIO OUT jack on the DVD Player and to the Digital Input jack on the back of the receiver. You must also set the Audio Equipment setting in the Setup menu to the correct setting (Dolby Digital or DTS – see p. 51 for more information).
3. Connect the video cable to the VIDEO OUT jack on your DVD Player and to the Video Input jack on your TV.

If your TV has an S-Video jack, connect the S-Video cable to the S-VIDEO jack on your DVD Player and to the S-Video jack on your DVD Player. If your TV doesn't have an S-VIDEO jack, don't connect the S-Video cable.
4. Connect the AC power cord to the AC IN jack on the back of your DVD Player, and plug the other end into an AC outlet.
5. Turn on your TV.
6. Turn your TV to the Video Input Channel. (If you don't know what channel is the Video Input Channel, please see p. 13).
7. Turn on your DVD Player.

Dolby Digital and DTS

Both Dolby Digital and DTS are audio formats used to record 5.1-channel, audio signals onto the digital track of film. Both of these formats provide six separate channels: left, right, center, left rear, right rear, and common subwoofer.

Remember, the disc will only play 5.1-channel sound if you've connected a DTS or Dolby Digital receiver or decoder and if the disc was recorded in the Dolby Digital or DTS format.

Please Read This Before Using the DIGITAL AUDIO OUT Jack!

This player's digital output jack is designed for a connection to a Dolby Digital or DTS receiver or decoder.

Older digital equipment may not be compatible with the Dolby Digital bitstream. Such a connection can create a high level of noise that may be harmful to your ears, and could damage headphones or speakers.

It is important to choose the correct setting in the DVD Player's Setup menu, especially when you use the DIGITAL AUDIO OUT jack.

If you are connecting your DVD Player to a Dolby Digital receiver, choose the *Dolby Digital* setting in the *Audio Equipment* menu (within the *Setup* menu). If you're connecting your DVD Player to a DTS receiver or decoder, choose the DTS setting in the *Audio Equipment* menu. For more information, see *Audio Equipment* menu information on p. 51.

Remove the Plastic Covers

If you're using the DIGITAL AUDIO OUT jack, check to see if there is a protective cover inside of the jack and on the ends of the optical digital cable. You must remove these protective covers before inserting the optical digital cable into the jack.

Setup and Connections

DVD Player + TV + Dolby Pro Logic, Dolby Digital or DTS Receiver

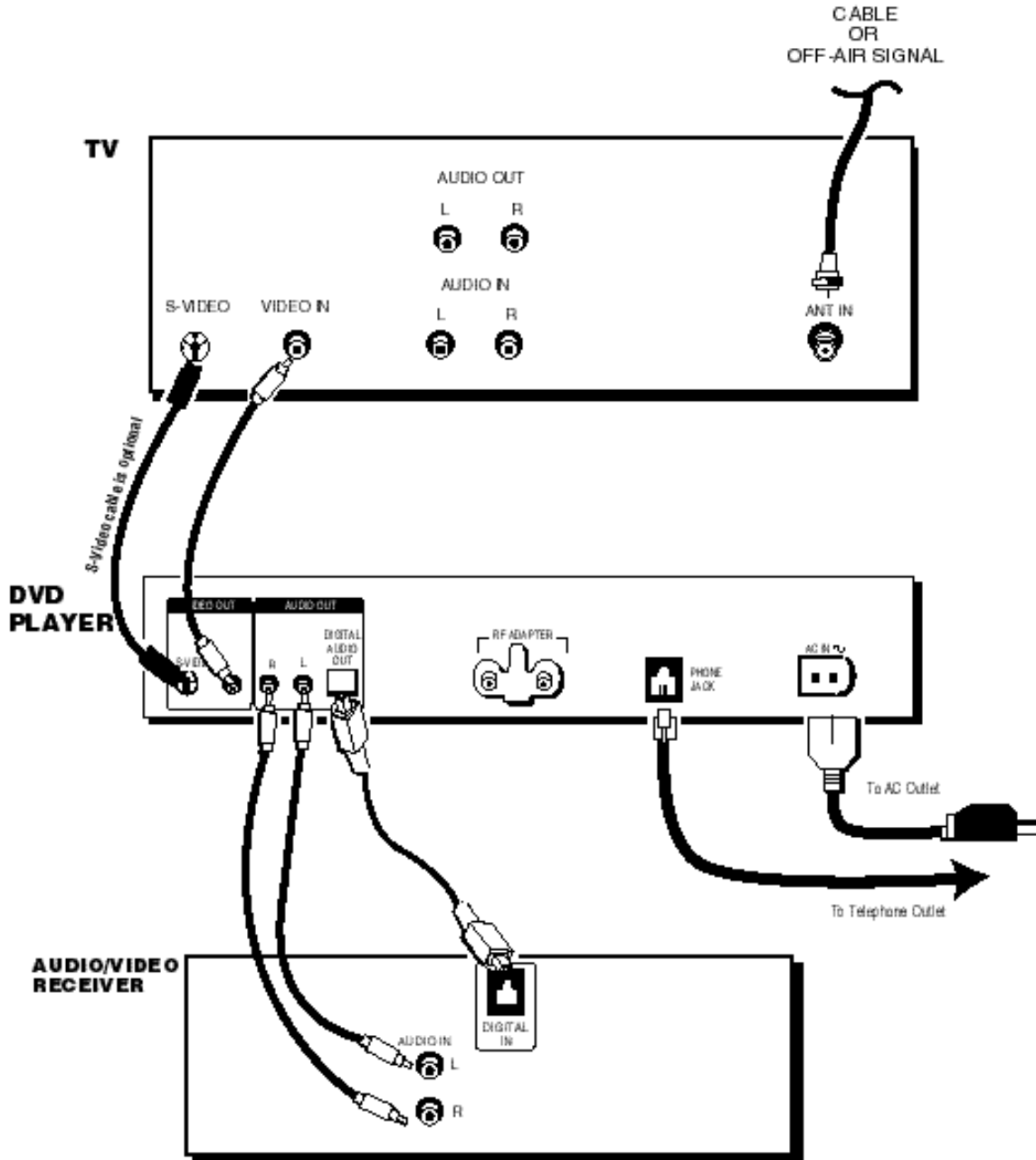

CAUTION

Do not stack electronic components or other objects on top of the DVD Player. See Safety Information on the inside front cover.

Consult the owner's manuals of the additional components you are connecting for more detailed connection information about those particular components.

Setup and Connections

Set the Menu Language

After you turn on your DVD Player the first time, the menu language screen appears.

By default, the player's menu language is set to English. If you want the on-screen menus to appear in English, press OK.

To change the language, press the down arrow button on the remote until the appropriate language is highlighted. Press OK.



Highlight the language you want the menu items to use and press OK on the remote control.

Other Language Options

The Menu Language feature sets the language for the text that appears on the menu screens.

You can choose other languages for subtitles and audio. For more information about subtitle and audio languages, see the section, "Using the Features in the Menu System" on pp. 46-47.

How to Move Around the DVD Player's Menu System

The technical term is "Navigation" — how you move through the DVD Player's menu system.

Even though this book tells you how to select different menu items, you can explore the menu system on your own by following a few "navigational rules."

Press the arrow buttons on the remote to move to different menu items on the screen. To select a menu item, press OK on the remote when the menu item is highlighted.

Highlighted means that the menu item stands out from the other menu items (appears brighter, darker, or a different color). In your DVD Player's menu, a highlighted item appears brighter than the other items on the screen.

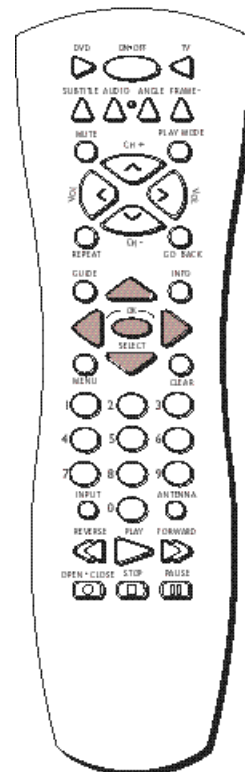

The buttons for navigation are shown in gray in this picture of the remote control. Use the four arrow buttons: up, down, left, and right, to highlight an item on the screen.

Press the OK button to select an item that is highlighted.

How to Find Your TV's Video Input Channel

You need to tune your TV to the Video Input Channel (or S-Video Channel if you connected the S-Video cable to your TV and to your DVD Player) to see the DVD Player's menu and to see the content that's on a disc. The video channel on TVs varies for different brands and different models. Below are some things to try.

- If your TV brand is RCA, GE, or PROSCAN, press the TV button on the remote that came with your DVD Player. Then press the INPUT button on the remote.
- If you have another brand, consult your TV Owner's Manual.

If those options don't work, try the following ideas. You might access the Video Input Channel by:

- pressing a button on the remote (see table below)
- selecting it from the TV's menu system (see table below)
- tuning directly to it by pressing a specific channel number (see table below)
- going through all of the channels in the channel list by pressing the channel up or down buttons on the TV.

Some common scenarios are listed in Video Input Channel Variations table that follows:

Video Input Channel Variations		
Button/switch on the TV	Button on the TV Remote	Channel #
VIDEO	VID 1	00
SIGNAL	LINE	90
VID 1	VID	91
VID 2	VIDEO	92
S-VID	S-VID	93
S-VIDEO	INPUT	VID 1
	S-VIDEO	VID 2
	SOURCE	
	AUX	

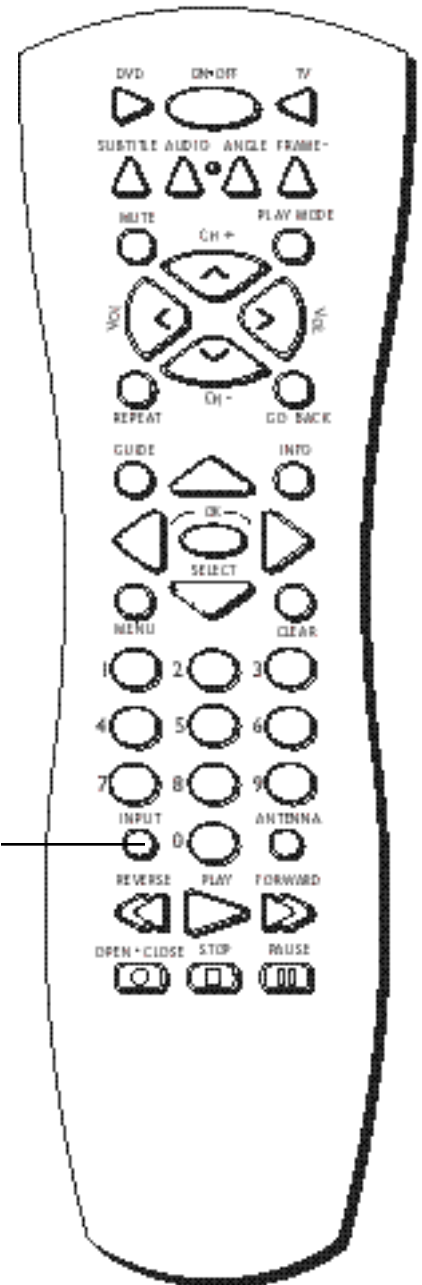

Setup and Connections

Tour of the Remote Control

You can use this remote to control compatible televisions. The TV button is programmed to operate most PROSCAN, RCA, and GE televisions. The remote can also operate other brands of televisions, but you must manually program it to do so (see "Programming the Remote" on page 86).

Component Buttons

In order for the remote control to operate a television or this DVD player, you must press the appropriate button to put the remote in the correct mode.

DVD Press this button to turn on the DVD Player and to set the remote to control the DVD Player.

TV Press this button to turn on most RCA, GE, or PROSCAN TVs and set the remote to control the TV. Used with ON•OFF button to turn on some other brands of TVs.

If you would like to operate more components from a single remote control, you can order a Universal Remote Control. The Universal Remote allows you to control a TV, the DVD player, two VCRs, a satellite receiver and an auxiliary component such as an Audio/Video Receiver. To order the Universal Remote Control, see page 89.

The Buttons Might Operate Differently for Other Components

The buttons on this remote control may operate differently for other components, especially when you're using the menu system of another component. For example, to select a menu item in your DVD Player's menu you press the OK button. However, for your television, you may need to press the MENU or the INFO button on this remote control to select a menu item.

(continued on next page)

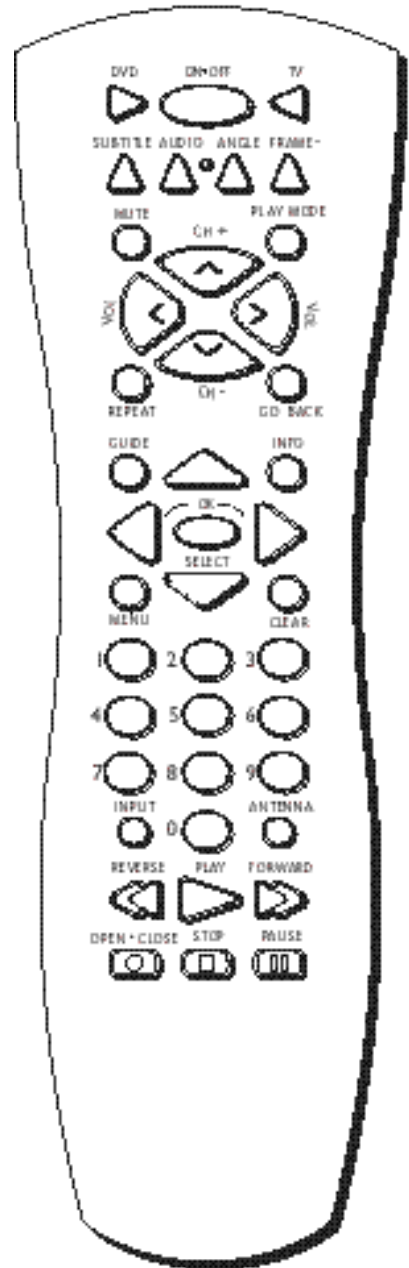

The component buttons (TV and DVD) are at the top of the remote control, near the ON•OFF button.

Other Remote Control Buttons (*listed alphabetically*)

This section describes what each button does when the remote is operating the DVD Player. You put the remote in "DVD mode" by pressing the DVD button on the remote.

The buttons on the remote may operate differently when the remote is controlling other components.

Example: When the remote is operating the DVD Player, pressing CH+ takes you to the beginning of the next chapter or track on the disc. When the remote is operating the TV, pressing CH+ takes you to the next channel.

Arrow buttons Use the arrow buttons (left, right, up, and down) to move through the on-screen menu. You highlight a menu item by pressing the arrow buttons. You select a highlighted item by pressing the OK button.

ANGLE Press this button to access various camera angles on a disc (if the disc contains multiple camera angles).

ANTENNA Lets you change the source of the video signal from satellite signals to an off-air antenna or cable signal and vice versa.

AUDIO Use this button to access various audio languages on a disc (if the disc contains multiple audio streams).

CH+ Allows you to move to the beginning of the next chapter or track on a disc (in effect, "skipping" the chapter or track).

CH- Allows you to move to the beginning of the preceding chapter or track on a disc (in effect, "skipping" the chapter or track).

CLEAR Clears the Info Display from the screen when you're playing a disc. When you're using the DVD Player's menu system, press CLEAR to go back to the DVD Player's main menu.

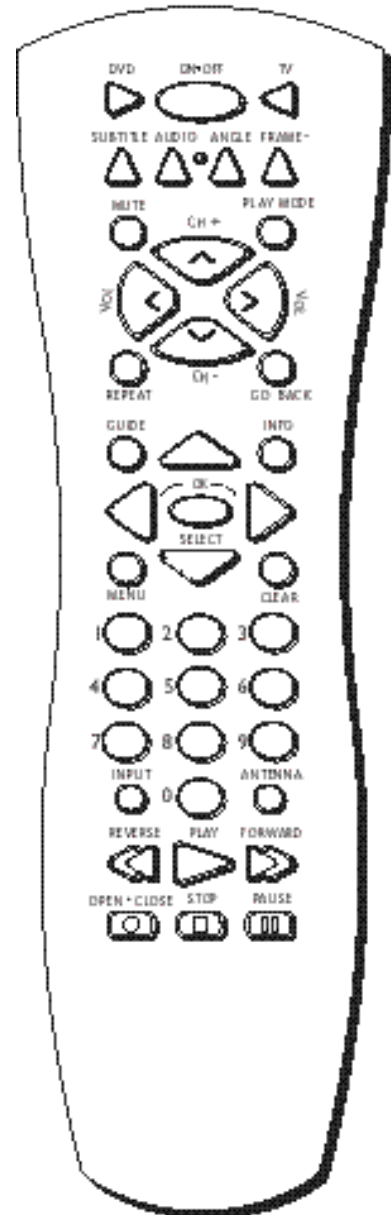

Note:

The remote packed with your DVD Player is programmed to operate most RCA, GE, and PROSCAN televisions. The remote can also operate other brands of televisions, but you must program it to do so (see page 86).

Setup and Connections

FORWARD Allows you to search forward through a disc while it is in play mode (or slow speed search in pause mode).

FRAME- Takes you to the previous frame when you're playing a disc.

GO BACK When you're using the DVD Player's menu system, press this button to return to the preceding menu screen.

GUIDE Allows you to see the titles that are available on the current disc (if the disc contains a guide menu).

INFO Press this button while you're playing a disc to see the on-screen Info Display. The Info Display contains various playback features and gives you information about the disc you're playing.

INPUT Use with the TV button to tune to the Video Input Channel.

MENU Press this button to see the disc's menu when you're playing a disc (press it again to resume playback).

MUTE Lowers the volume to an inaudible level.

Number buttons (0-9) Use the number buttons to input information such as chapter numbers, track numbers, or to make selections on some menu screens.

OK (same as SELECT button) Press this button to select a highlighted menu item.

ON•OFF Turns on the player when it is in standby mode; or puts the player in standby mode when power is on.

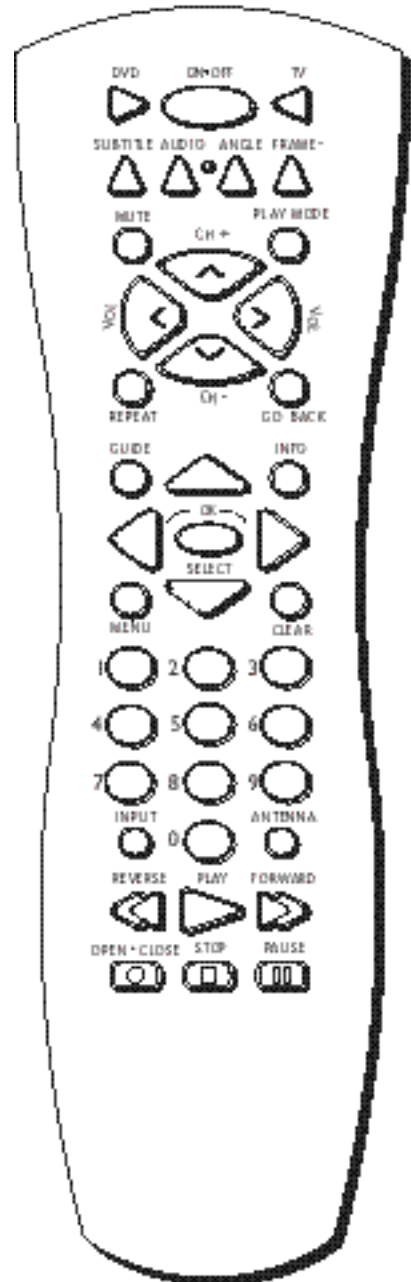

Setup and Connections

OPEN•CLOSE Opens and closes the disc tray.

PAUSE Pauses disc play. Also used for frame advance.

PLAY Begins disc play (and closes disc tray if it is open).

PLAY MODE When a disc is playing, press this button to access the play mode menu within the Info Display.

REPEAT Press this button to go to the Repeat menu within the Info Display. You can repeat a chapter, track, or an entire disc.

REVERSE Allows you to search backward through a disc while it is in play mode (or slow speed search in pause mode).

SELECT (same as OK button) Press this button to select a highlighted menu item.

STOP Stops disc play. You can also press STOP to remove the screen saver from the screen to see the DVD Player's main menu.

SUBTITLE When a disc is playing, press this button to make subtitles appear and disappear on the screen (if the disc was created with subtitles).

VOL up and down Adjusts the TV's volume level.

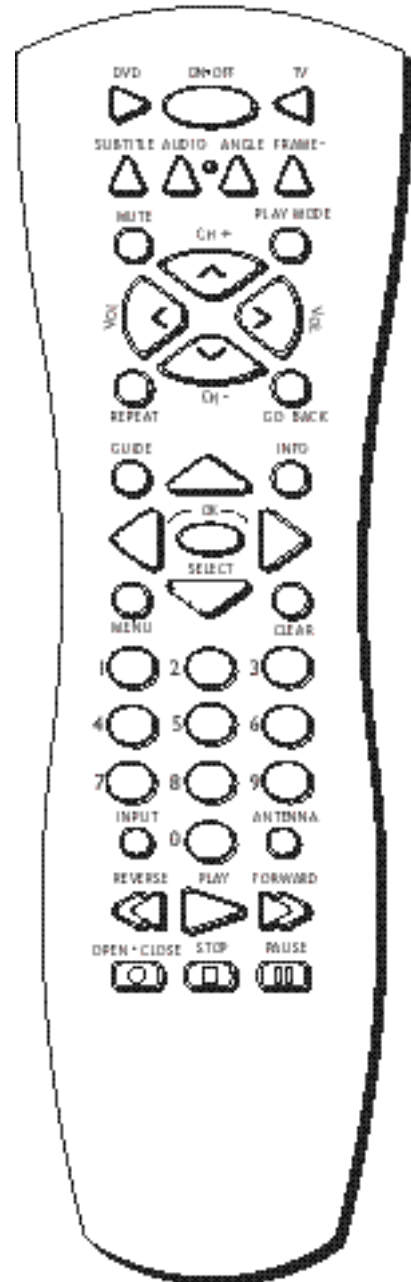

Setup and Connections

Helpful Hints about the Remote

Pick the Right Mode

Do you keep pressing the buttons on your remote control and nothing happens? The most common solution, according to our call center representatives, is putting the remote in the correct mode.

The remote control packed with your player is able to operate the DVD player or the television, but you have to tell the remote which component you want it to operate. If the remote is operating the TV, it's in TV mode and if it's operating the DVD, it's in DVD mode. So make sure you press the appropriate component button on the remote that matches the component you want the remote to operate.

Point the Remote in the Right Direction

Another tip—point the remote at the component. When you want the remote to operate the DVD Player, point the remote at the DVD Player not the TV. The remote has to be pointed in the correct direction and toward the correct component in order for the remote control's signal to communicate with the sensor on the component. You must make sure there is a clear path between the remote control and the component you want to operate so the signal isn't blocked.

**Component
buttons: TV and
DVD**

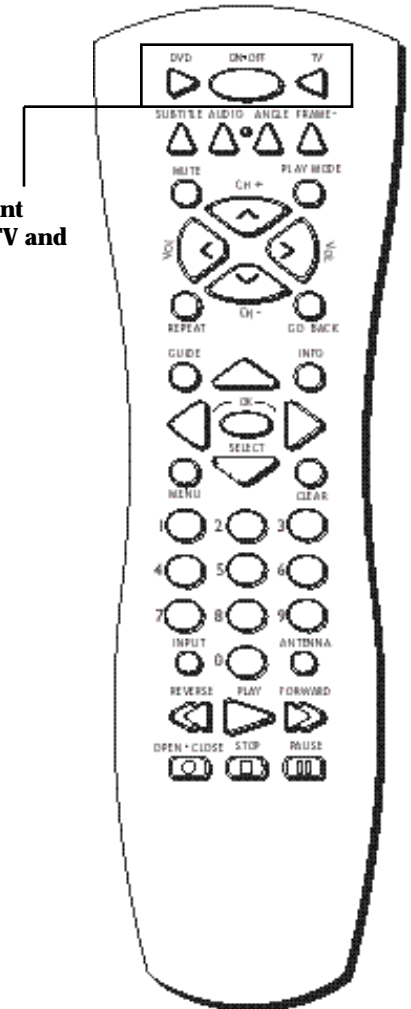

Playing Digital Video Discs

A New Way of Looking At Things

In this section you'll learn how to use your DVD Player to play Digital Video Discs.

You'll use the on-screen Info Display while you're playing a disc to use the different playback features of each disc. Please remember, an Info Display option will only work if the disc was programmed to support that option when it was made. For example, if you choose subtitles on the Info display, the subtitles will only appear if the disc was created with subtitles.

Regional Coding

Both the DVD Player and the discs are coded by region. These regional codes must match in order for the disc to play. If the codes don't match, the disc won't play. This player's code is Region No. 1.

Section Overview:

- **Loading and Playing Discs**
- **Using a Disc Menu**
- **Disc Playback Features**
- **Using the On-screen Info Display**



Playing Digital Video Discs

Loading and Playing a Disc

Before you load a disc, make sure that it is compatible with the player. The following discs CANNOT be used with this player:

- Video CDs
- Laserdiscs
- CD-I, CD-ROM, CD-R, DVD-ROM
- MiniDiscs
- Discs recorded using other broadcast standards (i.e. PAL or SECAM)
- CD-G discs (play audio only, not graphics)

To Load and Play a Disc

Make sure you've connected your DVD Player correctly (see "Setup and Connections") and turned it on (press ON•OFF on the player or press the DVD button on the remote control).

1. Press the OPEN•CLOSE button on the front of the DVD Player. The disc tray opens.
2. Place a disc gently into the tray with the disc's label facing up (double-sided discs have a label on both sides near the center).
3. Press the OPEN•CLOSE or PLAY button. The disc tray closes.

The DVD Player reads the disc's table of contents, and then one of three things happens depending on how the disc was "authored"—or programmed:

- The disc starts playing.
- The disc menu appears on the screen.
- The DVD Player's main menu appears on the screen. Press PLAY to begin playing the disc.



An example of a disc menu. The menus on discs vary because the disc menu is created by the disc's author.

4. Press STOP to stop playback.

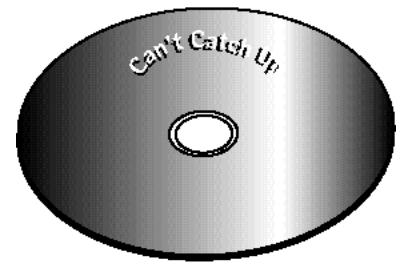

This is a single-sided disc (label side up)

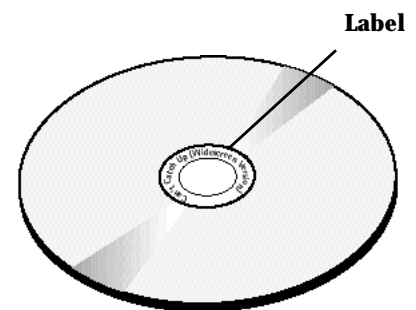

This is a double-sided disc

Accessing the Disc Menu

Many discs skip the disc menu and start playing automatically. To access the disc menu when you're playing a disc, press MENU on the remote.

Resume Feature

When you stop playing a disc, the player remembers where you stopped. When you start playing the disc again, the DVD Player picks up where you left off (unless the disc is removed or the player is unplugged).

If you press the STOP button twice accidentally, the resume feature won't work.

Using a Disc Menu

A disc is capable of having a menu—its own on-screen menu system is separate from the player's menu system. The disc menu may allow you to change features such as language and playback settings.

Although the content and operation of disc menus vary from disc to disc, the following example should give you a pretty good idea of what to expect.

1. While the disc is playing, press MENU. The disc menu appears.
2. Press the up and down arrow buttons to highlight the section of the disc menu you want to choose, and press OK.



The Language setting is highlighted: press OK to see the language options on this disc.

3. Press the up and down arrows to select a language, and press OK.



English is highlighted: press OK to play the disc with English dialog.

4. Press MENU to resume playback.

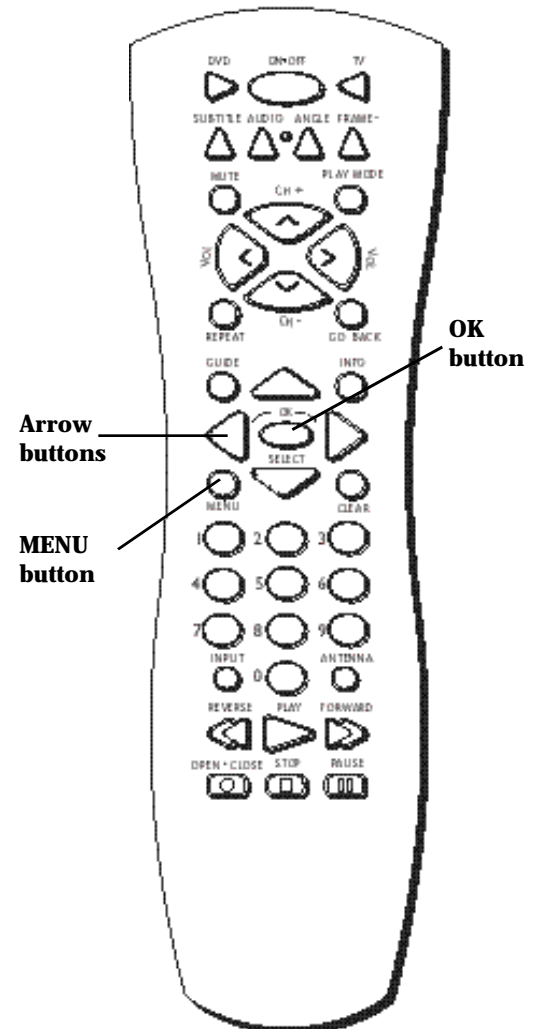

Default Settings

Any settings you change on the disc menu only override the settings in the DVD Player's menu system temporarily.

Default settings are the settings that you set up in the DVD Player's menu system. To change the default settings, see the section "Using the Features in the Menu System" on pp. 33-53.

Playing Digital Video Discs

Disc Playback Features

Fast Motion Playback (Picture Scan)

To scan through the disc when you're playing it, use the Picture Scan feature.

1. Press the REVERSE or FORWARD button on the remote when you're playing a disc.
2. Press the button again to scan at a faster speed.
3. Press the PLAY button at any time to resume normal playback.

Notes:

You won't hear the sound (audio) on the disc when you're using the picture scan feature.

Playback features aren't available during the opening credits of a movie.

Freeze Frame and Frame Advance

1. Press PAUSE when a disc is playing to freeze the picture.
2. Each time you press the PAUSE button, the picture advances one frame. Each time you press the FRAME- button, the picture reverses one frame.
3. Press PLAY to resume normal playback.

Note: Playback features aren't available during the opening credits of a movie.

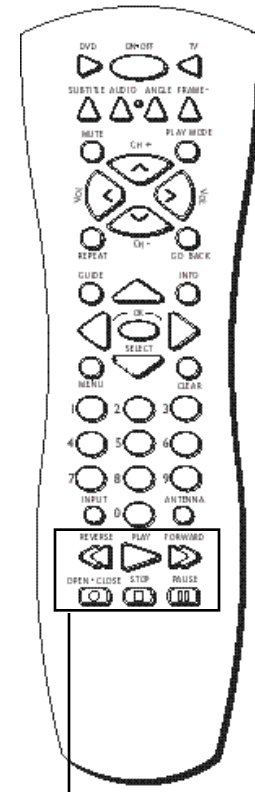

Playback buttons

Slow Motion Playback (in Freeze Frame Mode)

While the disc is in freeze frame mode, you can use slow motion playback.

1. While the disc is playing, press PAUSE on the remote.
2. Press the REVERSE or the FORWARD button.
3. Press the button again to increase the slow motion, playback speed.
4. Press PLAY to resume normal playback.

Note: Playback features aren't available during the opening credits of a movie.

Chapter Advance

While a disc is playing, you can go forward or backward a chapter at a time.

- Press CH+ or CH- to go forward or backward through the disc a chapter at a time.

Playback Features Might Not Be Available During Opening Credits

Playback features, such as fast forward, might not work during the opening credits and warning information that appear on the screen at the beginning of a movie because of the way the movie on the disc is formatted.

Playback features are disc-dependent, and may not work with all discs.

Slow Motion Backward

Scanning backward doesn't provide as clear of a picture as searching forward. The picture may appear "jumpy."

This is the nature of MPEG-2, which is the digital video data standard of the Motion Pictures Experts Group (MPEG) that allows more content to fit on one disc.

Playing Digital Video Discs

Using the On-Screen Info Display

The on-screen Info Display contains many playback features. To see the Info Display, press INFO while a disc is playing. Use the arrow buttons to move through the different features in the Info Display. Each feature is illustrated with an icon.

Use the arrow buttons to highlight an Info Display icon. When an icon is highlighted, press OK to select it.

Please remember, you can only access the Info Display when you're playing a disc. Also, the Info Display features are only available if the disc was created with that particular feature (i.e., if you select the Subtitle icon, you won't be able to change the subtitle language unless the author of the disc created the disc with subtitles).

The invalid symbol  appears on the screen when you press a button that doesn't have any function. If one of the icons is "grayed out," the Info Display feature isn't available for the disc you're playing. To make the Info Display disappear from the screen, press INFO or CLEAR on the remote control.

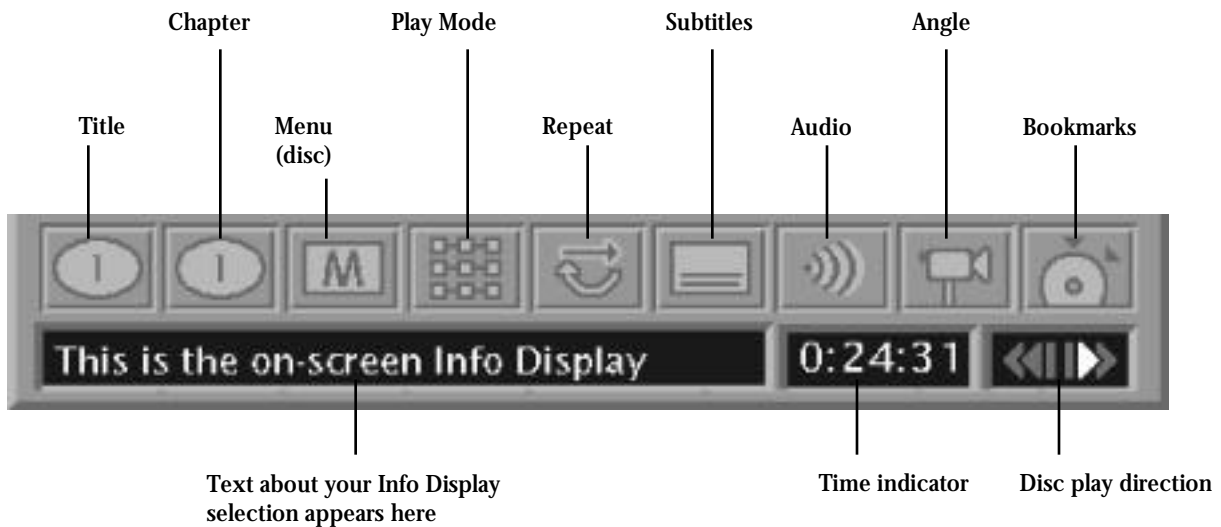

Selecting a Title

Some discs contain more than one Title. For example, there might be four movies on one disc (each movie might be considered a title).

1. Make sure your remote control is in DVD mode by pressing the DVD button on the remote.
2. During disc playback, press INFO on the remote.
3. If the Title icon on the Info Display isn't highlighted, press the appropriate arrow button(s) to highlight it.
4. Use the number button(s) on the remote to enter the title number.
5. Press OK when the Title you want to play, appears in the text window.

Note:

Some discs only have one title.



Selecting a Chapter

Because DVD discs use digital technology, a title can be divided into individual chapters (similar to tracks on a CD). You can skip to a specific chapter by using the Chapter section in the Info Display.

1. Make sure your remote control is in DVD mode by pressing the DVD button on the remote.
2. While a disc is playing, press INFO on the remote.
3. Press the right arrow button until the Chapter icon is highlighted.
4. Use the number buttons on the remote to enter the number of the chapter you want to play.
5. Press OK.

Notes:

- The Chapter feature won't work if the disc isn't formatted with separate chapters.
- When you enter a one-digit chapter number, you may have to press OK after pressing the number button. This varies depending on the number of chapters within the title you're playing.



Using the Menu Icon

The Menu icon on the Info Display accesses the disc's menu.

1. Make sure your remote is in DVD mode by pressing the DVD button on the remote control.
2. While a disc is playing, press INFO on the remote. The Info Display appears on the screen.
3. Press the right arrow button until the Menu icon is highlighted and then press OK.
4. Press MENU to start playing the disc again.

Shortcut: Press MENU on the remote while the disc is playing. The disc's menu appears.

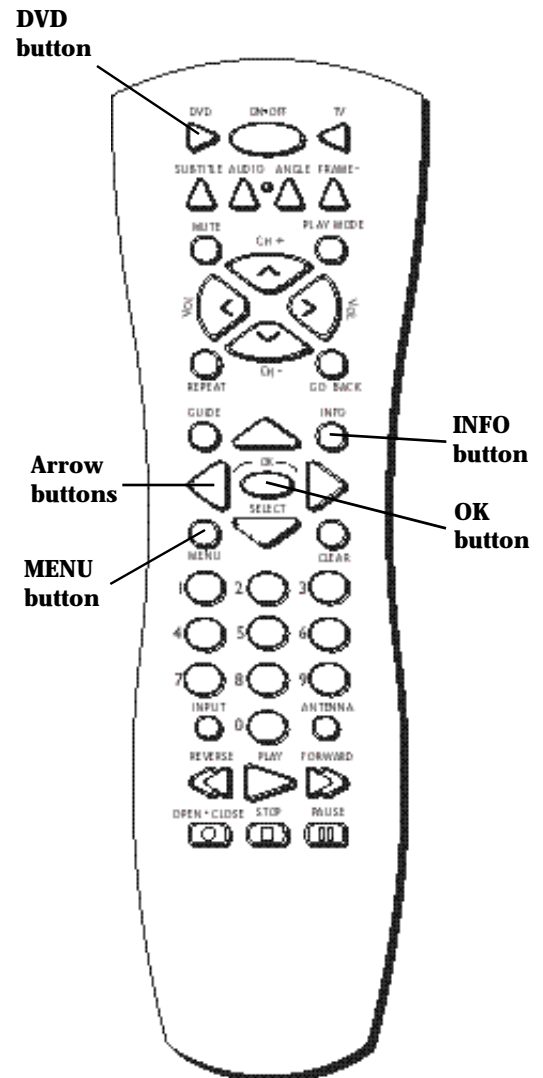

Playing Digital Video Discs

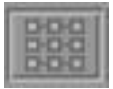

Selecting Different Play Modes

There are three play modes available in the Info Display:

- Standard
- Random
- Program

To change the way a disc plays:

1. Press INFO on the remote.
2. Press the right arrow button until the Play Mode icon is highlighted, and press OK. The Play Mode menu appears.



3. Press the arrow buttons to highlight one of the three play modes (Standard, Random, or Program), and press OK.
4. Press the down arrow button to highlight Done. Press OK.
5. To make the menu disappear from the screen, press CLEAR on the remote.

Notes:

- **Shortcut:** Press the **PLAY MODE** button on the remote control when the Info Display is on the screen instead of using the arrow buttons to highlight the Play Mode icon.
- If a Play Mode option isn't available for the disc you're playing, you won't be able to highlight the selection.
- You must create the program in order to use the Program option (see "How to Create a Program" on p. 37).

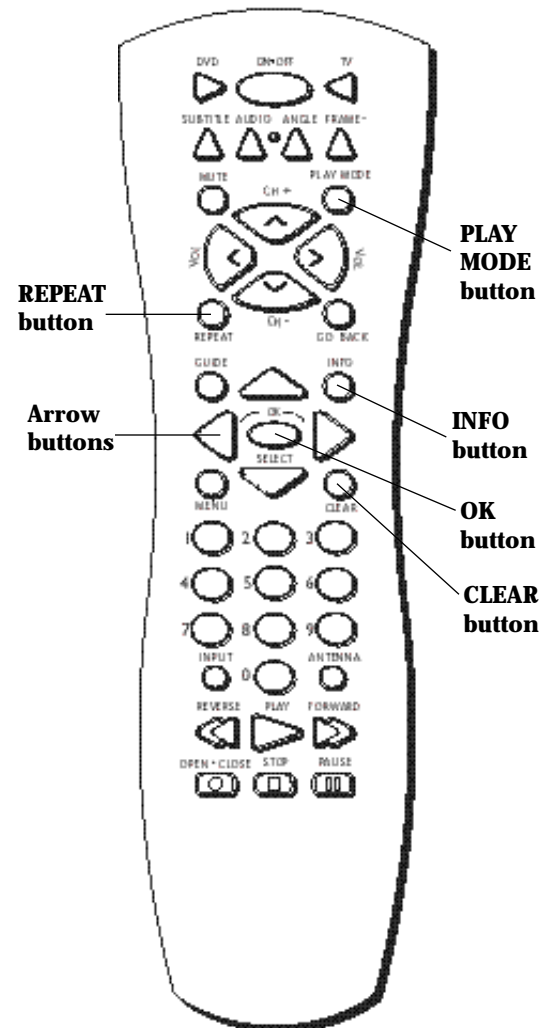

(continued on next page)



Using the Repeat Feature

There are four Repeat options:

- Disc – repeats the disc that is playing
- Title – repeats the title that is playing
- Chapter – repeats the chapter that is playing
- A•B – Set the beginning (point A) and the end (point B) to make this part of the movie play repeatedly.

To Use Repeat:

1. Make sure your remote control is in DVD mode by pressing the DVD button on the remote.
2. While a disc is playing, press INFO on the remote. The Info Display appears.
3. Press the right arrow button until the Repeat icon is highlighted. Press OK. The Repeat menu appears.

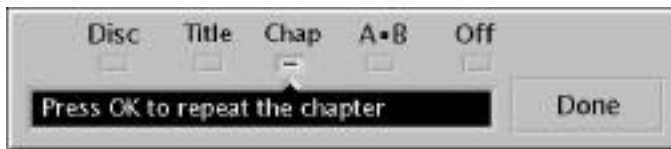

4. Press the arrow buttons to highlight one of the Repeat options. Press OK.
5. Press the down arrow button to highlight Done.
6. Press OK. The Info Display appears on the screen with the Repeat icon blinking to inform you that the Repeat feature is on.

Shortcut: Press the REPEAT button on the remote when the Info Display is on the screen instead of using the arrow buttons to highlight the icon.

DVD button

REPEAT button

Arrow buttons

INFO button

OK button

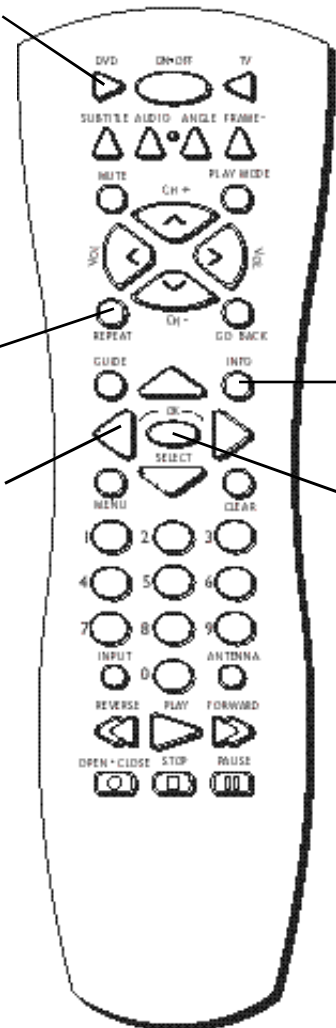

Playing Digital Video Discs

A•B Repeat Deserves Some Extra Instruction

A•B Repeat lets you repeat a specific segment on the disc that you define. For example, my son loves to watch the dogfight in the movie Top Gun. To watch this scene over and over:

1. Press INFO on the remote and select the Repeat icon from the Info Display.
2. Press the right arrow button to select A•B. Press OK to set the A point appears in the text window.
3. Press FORWARD or REVERSE on the remote to move to the part of the disc that you want to be the beginning of the segment that is going to repeat (the A point).
4. Press OK.
5. Press FORWARD or REVERSE on the remote to go to the part of the disc that you want to be the end of the segment that will repeat (the B point).
6. Press OK.
7. Press the down arrow to highlight Done and press OK. The Info Display appears on the screen with the Repeat icon blinking.
8. To make the Info Display disappear from the screen, press CLEAR on the remote.

How to Cancel Repeat

There are three ways to cancel Repeat:

- Press STOP twice.
- Go to the Repeat Menu in the Info Display and select Off.
- Eject the disc.

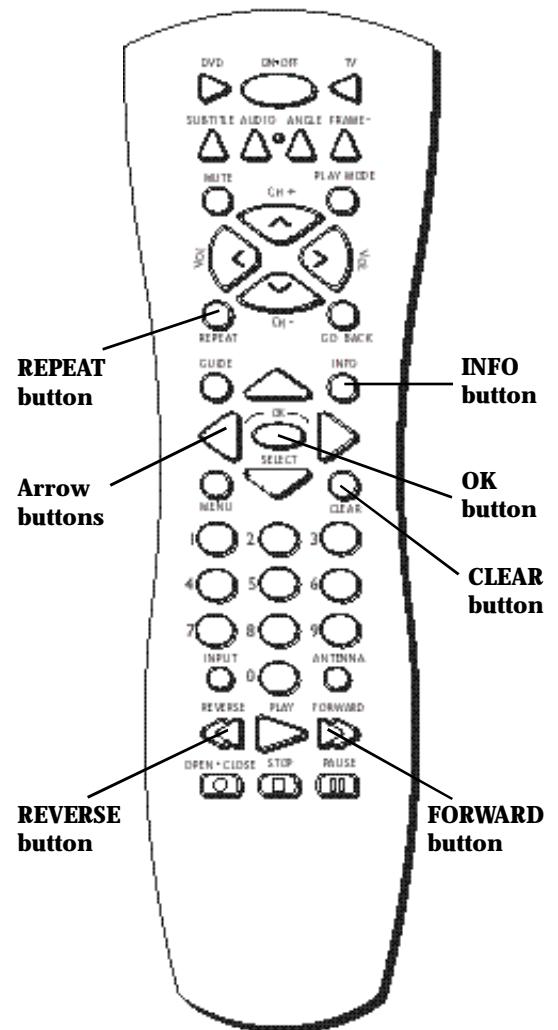



Changing the Subtitle Language

You can change the Subtitle language while you're watching a disc, but only if the disc was created with subtitles.

1. Make sure your remote control is in DVD mode by pressing the DVD button on the remote.
2. While a disc is playing, press INFO on the remote.
3. Press the right arrow button until the Subtitle icon is highlighted. Press OK. The Subtitle menu appears.



4. Press the right and left arrow buttons to see the different subtitle languages that are available on the disc.
5. When the subtitle language you want to use appears in the text window, press OK on the remote.
6. Press the down arrow button to highlight Done. Press OK.
7. To make the menu disappear from the screen, press the CLEAR button on the remote.

Notes:

- The subtitle feature only works if the disc was created with subtitles.
- When you choose a subtitle language from the Info Display, you only override the subtitle language setting in the DVD Player's main menu (in the *Lang Prefs* menu within the *Setup* menu) temporarily.

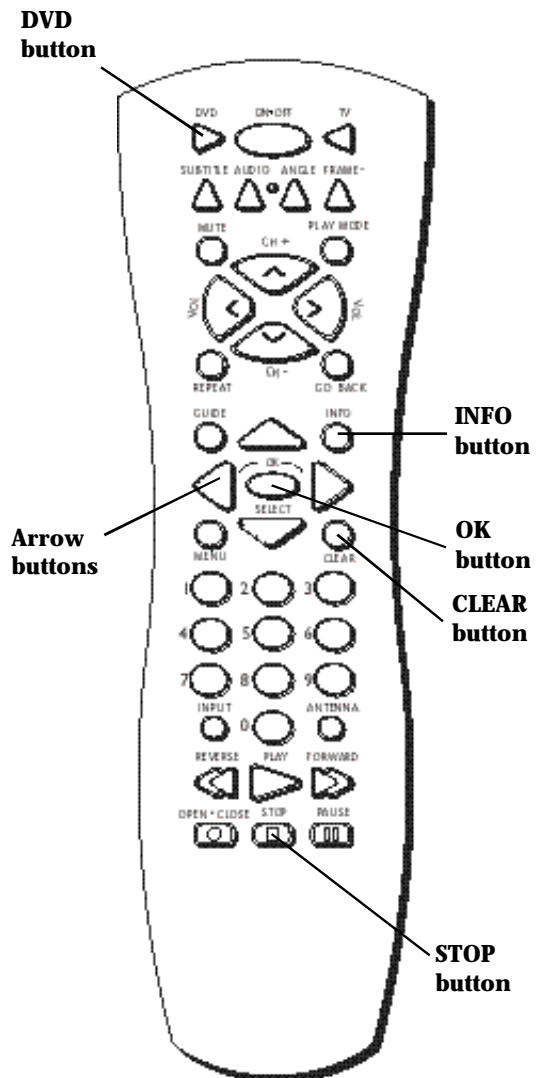

Playing Digital Video Discs



Changing the Audio Language

If the disc was created with different language tracks, you can use the Info Display to temporarily change the DVD Player's Audio setting.

1. Make sure your remote control is in DVD mode by pressing the DVD button on the remote.
2. Press INFO on the remote. Press the right arrow button until the Audio icon on the Info Display is highlighted.
3. Press OK. The Audio Menu appears.



4. Press the right and left arrow buttons to see the audio languages that are available on the disc.
5. When the audio language you want to use appears in the text window, press OK on the remote.
6. Press the down arrow button to highlight Done and press OK.
7. To make the menu disappear from the screen, press CLEAR on the remote.

Notes:

- The language feature only works if the disc was created with multiple audio tracks.
- When you choose an audio language from the Info Display, you only override the audio language setting in the DVD Player's main menu (in the *Lang Prefs* menu within the *Setup* menu) temporarily.
- Shortcut: Press the AUDIO button on the remote control when the Info Display is on the screen instead of using the arrow buttons to highlight the Audio icon.

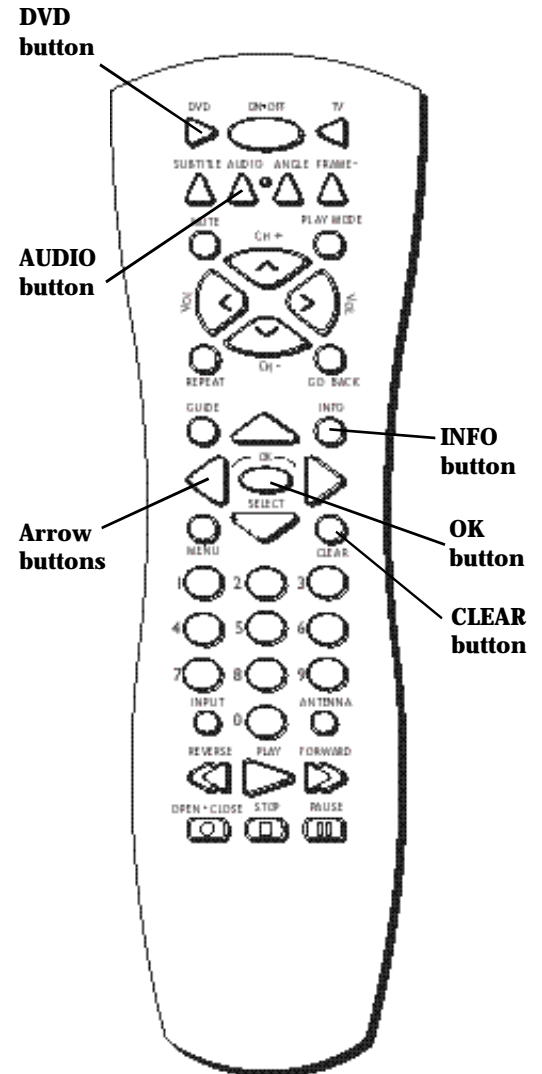



Changing the Camera Angle

Some discs contain multiple angles of a particular scene or sequence. If the disc only has one angle, this feature won't work.

1. Make sure your remote control is in DVD mode by pressing the DVD button on the remote.
2. While a disc is playing, press INFO on the remote. The Info Display appears.
3. Press the right arrow button until the Camera Angle icon is highlighted, and press OK. The Angle Menu appears.



4. Use the right and left arrow buttons to highlight an angle.
5. When the angle you want to use appears in the text window, press OK on the remote.
6. Press the down arrow button to highlight Done and press OK.
7. To make the Info Display disappear from the screen, press CLEAR.

Shortcut: Press the ANGLE button on the remote control when the Info Display is on the screen instead of using the arrow buttons to highlight the Angle icon.

DVD button

Arrow buttons

INFO button

OK button

CLEAR button

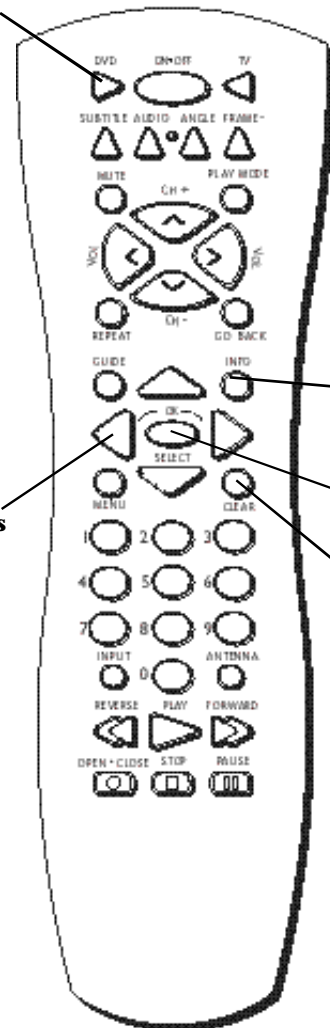

Using Bookmarks

The bookmark feature lets you mark a point on the disc that you can go to quickly. You can store up to 10 bookmarks.

Storing a Bookmark

1. Make sure your remote control is in DVD mode by pressing the DVD button on the remote.
2. While a disc is playing, press INFO on the remote.

(continued on next page)

Playing Digital Video Discs

Storing a Bookmark (continued from previous page)

- Use the right arrow button to highlight the Bookmark icon.
- Press OK. The Bookmark Menu appears.



- When you reach the scene you want to mark, press OK.
- Press the down arrow button to highlight Done. Press OK.
- Press CLEAR on the remote to make the Info Display disappear from the screen.

Recalling a Bookmarked Scene

- While you're playing a disc, press INFO on the remote. The Info Display appears.
- Press the right arrow button on the remote until the Bookmark icon is highlighted.
- Press OK.
- Press the up arrow button to get to the Go To part of the Bookmark menu.
- Use the right arrow button to select the bookmarked scene you want to activate.
- Press OK to activate the bookmark.
- To make the Info Display disappear from the screen, press CLEAR on the remote.

Clearing a Bookmark

The bookmark is cleared each time a disc is removed from the player or when the power is turned off.

If all 10 bookmarks are in use, you can still mark new scenes, but the previous bookmarks will be erased.

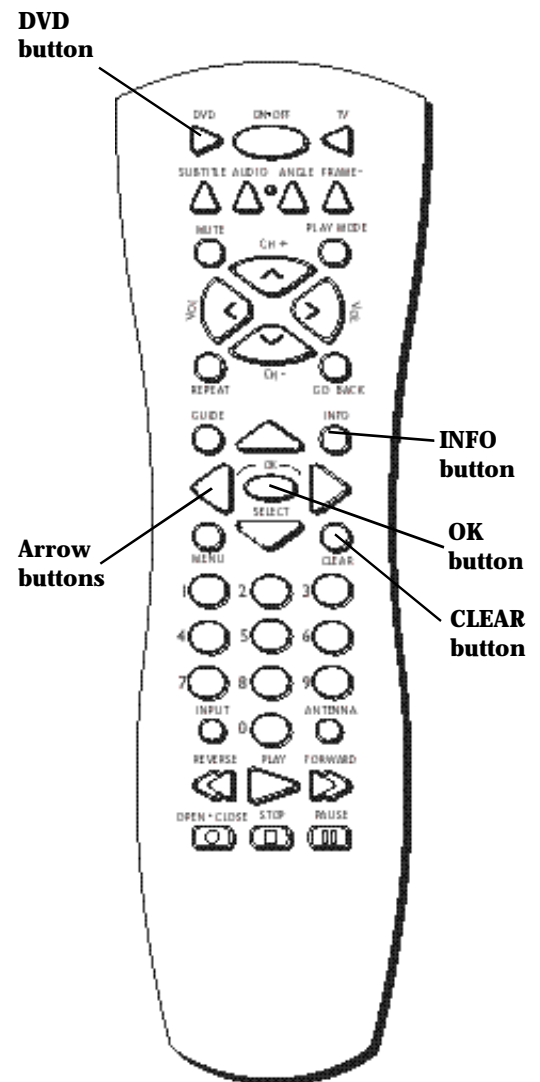

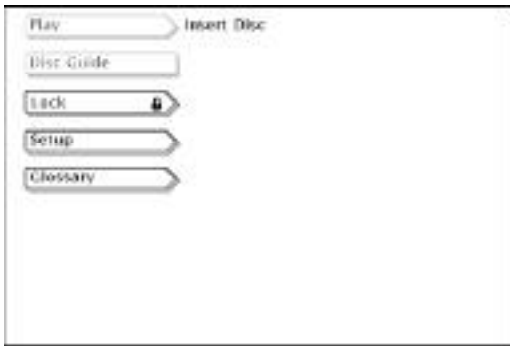

Using the Features in the Menu System

Putting You In Control

This section describes other features and settings that are accessed in your DVD Player's main menu. This menu system lets you customize your DVD player — set up rating limits, choose various language preferences, change the TV image setting, and more!

I've written specific steps for each menu item, but you can also play around with the menus by following a couple of navigational rules that are described on the next page.

Section Overview

- **Let's Talk About Navigation**
- **Play Menu**
- **Disc Guide Menu**
- **Lock Menu**
- **Setup Menu**
- **Glossary**

Using the Features in the Menu System

Let's Talk About Navigation

How to use your Remote to Move through the Player's Menu System

We use the term "highlighted" repeatedly when explaining how to move through the menus.

Highlighted means that a particular item stands out from the other items on the screen. In your DVD Player's menu system, a highlighted item appears brighter than the other options on the screen.

Here's how you navigate:

- Use the arrow buttons (up, down, right, and left) to highlight different items in the menu system.
- Press OK to choose an item that you've highlighted.
- Press GO BACK on the remote to return to the previous set of menu items. (Or you can press the left arrow button to go back to the previous menu if it seems faster to you.)
- Press CLEAR to return to the main menu: the first set of menu screens.

Two types of menus: path and static

Path Menu Item

A path item is denoted with an arrow to let you know this option is a path to MORE options. To see the path menu options, highlight the path menu and press OK. The next set of menu items appears.

The Play menu is an example of a path menu— when the Play menu is highlighted, press OK. The Play options appear on the screen.

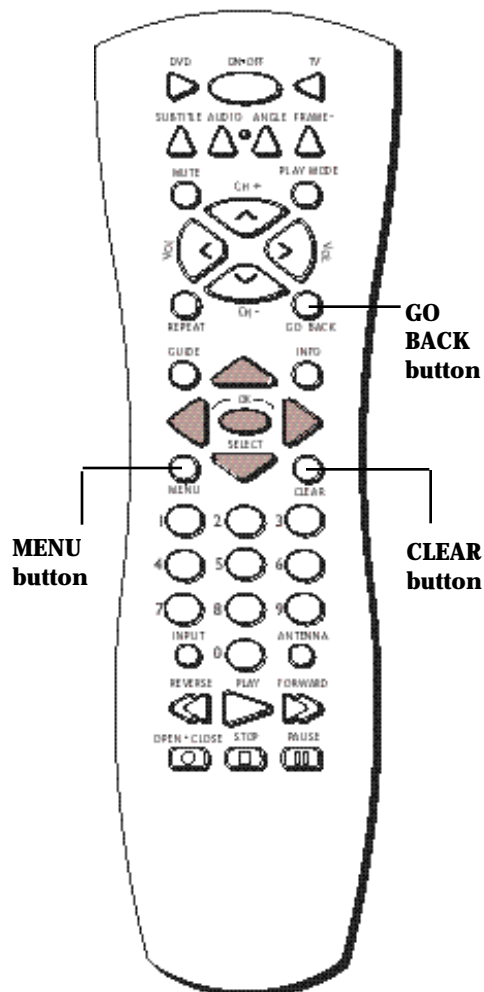

The buttons used for navigation are shown in gray (the OK button, and the up, down, left and right arrow buttons). Press MENU to see the DVD Player's main menu.

Using the Features in the Menu System

Static Menu Item

Static menu items are used in two ways:

With a static menu item, what you see is what you get. When a static menu is highlighted, press OK and that action is taken. Disc Guide on your player's menu system is an example of a static menu item. Press OK when Disc Guide is highlighted and the disc guide (the disc's menu) appears.

Sometimes a static menu is used as a "toggle." You highlight the static menu, press OK, and the selection changes from one choice to another. AutoPlay within the Setup menu is an example of a static menu item that is a toggle. Highlight AutoPlay, and press OK. The selection changes from On to Off and vice versa, each time you press OK.

Additional Menu Information

Menu item is "grayed out" — this item isn't available (i.e., Play and Disc Guide appear "grayed out" if you haven't put a disc in the player).



This is called, the "Go Back" icon — when it is highlighted, press OK to return to the previous menu.

Notes:

You must make sure the remote is in DVD mode (press the DVD button on the remote control) in order to move through the Player's menu. This is a frequent solution to consumer problems, according to our Consumer Relations department.

Throughout the menu, the text at the bottom of the screen gives you instructions on how to perform a task.

Since your TV is color and this book isn't, we've adjusted the appearance of the menus for better readability.

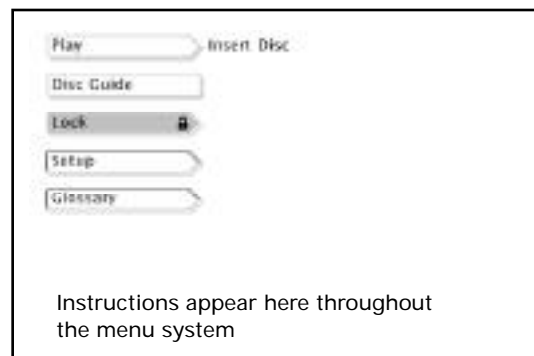

The *Play* menu and *Disc Guide* appear "grayed out" because those menus aren't available since there isn't a disc in the player.

Using the Features in the Menu System

The Play Menu Options

The DVD Player's Play menu enables you to choose different ways to play the disc. To see the Play menu options, a disc must be in the DVD player.

1. Make sure your remote is in DVD mode by pressing the DVD button.
2. If the disc is playing, press STOP. The DVD Player's main menu appears.
3. If the Play path item isn't highlighted, press the up arrow button to highlight it.
4. Press OK. The Play menu items appear.

Standard Play: plays the discs titles and chapters in their default order (i.e., chapter 1 of Title 1 plays first, then chapter 2 of Title 1, etc.)

Random Play: plays the chapters of each title in random order.

Program Play: you program your player to play the chapters on the disc in the order you choose (you must select Edit Program and set up the order in which you want the chapter(s) and title(s) on the disc to play).

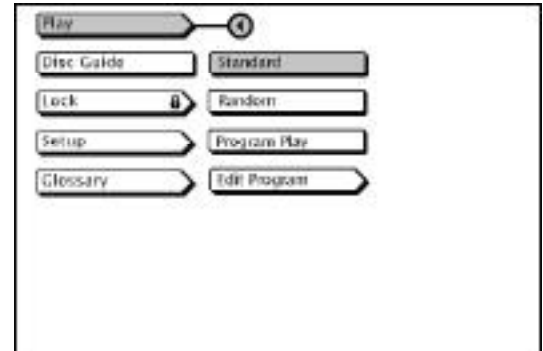

To access the *Play* menu options, highlight *Play* and press OK.

Using the Features in the Menu System

How to Create a Program:

1. After selecting the Play menu, press the down arrow button until Edit Program is highlighted.
2. Press OK. The Playlist menu appears.
3. Press the number buttons on the remote to choose the title. The cursor goes to the Chapter section). If there is only one title on the disc, you have to press the right arrow button to highlight the Chapter section.
4. Press the number buttons to choose the chapter (use two digits, i.e., press 05 instead of 5 for chapter 5). Add is automatically highlighted.
5. Press OK to add the title and chapter you entered as the first item on your Playlist. Your entry appears in the Playlist area.
6. Repeat steps 1-3 to enter additional title/chapter selections.
7. When you've entered all of the title/chapter selections that you want to include in your playlist, press the appropriate arrow button(s) to highlight Done. Press OK. The Play options menu appears.

Note:

If you want to play the disc in the order you just programmed, press the appropriate arrow button(s) on the remote to highlight *Play* and press OK.



To create a program, highlight *Play* and press OK. Highlight *Edit Program* and press OK. The playlist appears. Enter the title and chapters and select *Done* when you're finished.

How to Delete or Edit a Program:

1. After selecting the Play menu, press the down arrow button until Edit Program is highlighted.
2. Press OK. The Playlist menu appears. Press the appropriate arrow buttons to highlight the entry in the playlist that you want to delete. Press OK.
3. Press the appropriate arrow button to highlight Delete
4. Press OK. The playlist item that is highlighted is deleted.
5. Continue deleting playlist items as explained above. When you're finished, press the appropriate arrow button on the remote to highlight Done. Press OK.



To edit a program, highlight the playlist from the *Edit Program* menu. Use the arrow buttons to highlight an item in the playlist. Select the item by pressing OK. Highlight *Delete* and press OK to delete that item.

Using the Features in the Menu System

Disc Guide

The DVD Player's Disc Guide menu enables you to access the disc's guide from the DVD Player's main menu. A disc guide lists all of the titles on the disc, but some discs don't have a disc guide. To access the disc's guide, make sure a disc is in the DVD player.

1. Make sure your remote is in DVD mode by pressing the DVD button.
2. If the disc is playing, press STOP. The DVD Player's main menu appears.
3. Press the down arrow button until Disc Guide is highlighted.
4. Press OK. The disc's menu appears.
5. To return to the DVD Player's menu when the disc menu is on the screen, press STOP on the remote.

Notes:

The Disc Guide, which lists all of the movies on a disc, isn't the same as the disc menu (or the menu for the movie that's on the disc.) You access the menu for the movie you're playing by pressing MENU on the remote when you're playing the movie.

Not all discs have a disc guide.

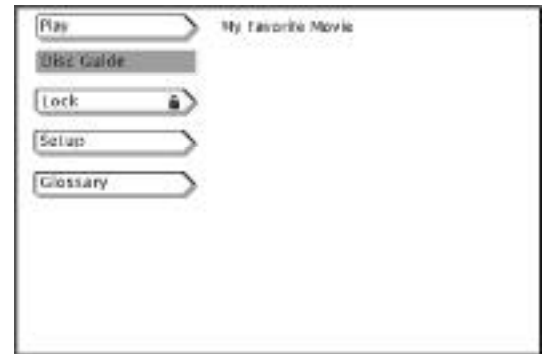

You can access the disc's guide from the player's main menu. Highlight *Disc Guide* and press OK.

Using the Features in the Menu System

How to Use the Lock Menu

The padlock icon tells you whether your player is locked or unlocked.

🔒 Locked: A password is needed in order to play discs that aren't included in the rating limits you have set. Nobody can access the Lock Menu items (Unlock Player, Change Password, etc.) without entering the password.

🔓 Unlocked: A password isn't required to play discs.

To Lock your DVD Player:

1. Make sure your remote is in DVD mode by pressing the DVD button.
2. If the disc is playing, press STOP. The DVD Player's main menu appears.
3. Press the down arrow button until Lock is highlighted.
4. Press OK. The Lock menu items appear.
5. Press the up arrow button to highlight Lock Player.
6. Press OK. Enter New Password screen appears.
7. Press the number keys on the remote to enter the password you want to use (similar to entering your PIN when you use a bank machine).
8. After you've entered the last number in the password, press OK. Confirm Password appears.
9. Enter the numbers you entered the first time and press OK when you're finished. The previous menu appears.

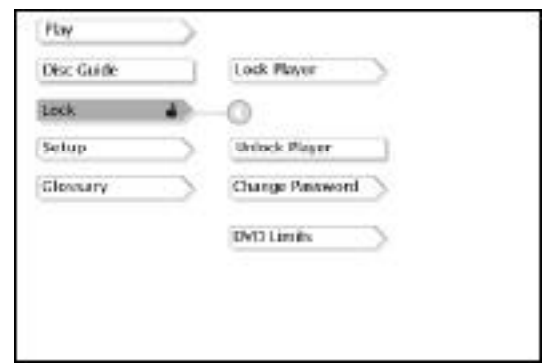

To lock your DVD player, highlight *Lock* and press OK on the remote. Highlight *Lock Player* and press OK.

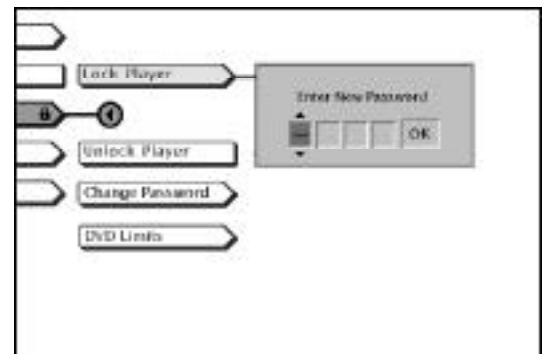

When you select *Lock Player*, you must enter the password you want to use. Use the number buttons on the remote control to enter your password numbers and press OK.

The Disc Tray is Locked

If the message "*Tray Locked*" appears on the screen, the retail lock feature has been accidentally engaged. To unlock the disc tray you must press and hold a combination of keys simultaneously:

On the front panel of the DVD Player, press and hold the STOP, ON•OFF and OPEN•CLOSE buttons for at least 3 seconds.

Using the Features in the Menu System

To Unlock the Player:

1. Make sure your remote is in DVD mode by pressing the DVD button.
2. If the disc is playing, press STOP. The DVD Player's main menu appears.
3. Press the down arrow button until Lock is highlighted.
4. Press OK. Enter Password appears on the screen.
5. Enter your password and press OK.
6. Use the arrow button to highlight Unlock Player and press OK. The lock icon appears unlocked.

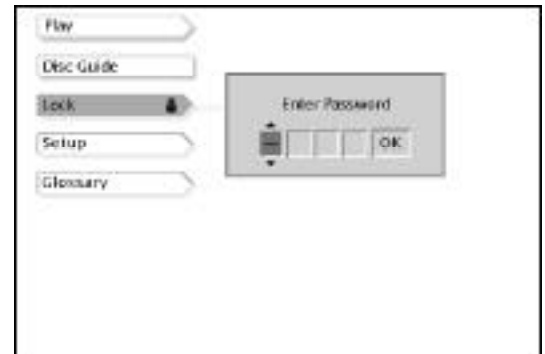

To unlock the player: highlight *Lock*, press OK on the remote, and enter your password. The *Lock* menu items appear.

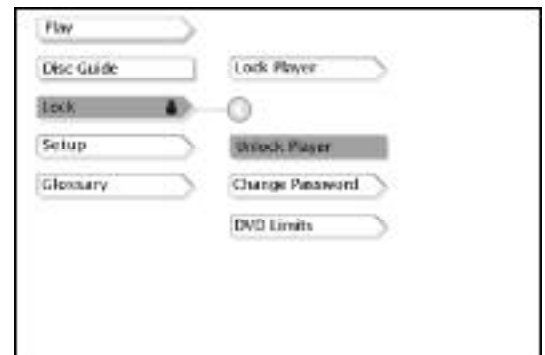

Highlight *Unlock* and press OK to finish unlocking the player.

Using the Features in the Menu System

How to Change Your Password

The player must be locked to change the password.

1. Make sure your remote is in DVD mode by pressing the DVD button.
2. If the disc is playing, press STOP. The DVD Player's main menu appears.
3. Press the down arrow button until Lock is highlighted.
4. Press OK. Enter Password appears on the screen. Enter your password.
5. Press the arrow button to highlight Change Password, and press OK.. Enter New Password appears.
6. Press the number buttons on the remote to enter the new password you want to use and press OK. Confirm Password appears.
7. Press the number keys to enter the password again and press OK when you're finished.

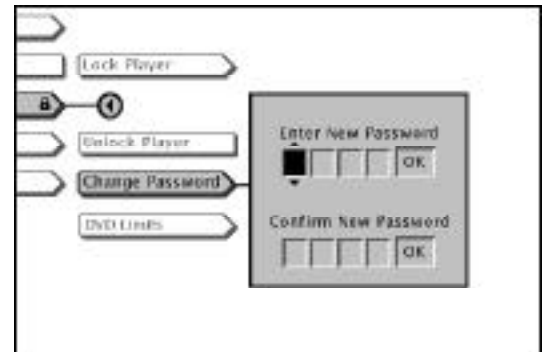

The player must be locked to change your password. Highlight *Lock* and press OK on the remote. Enter your password. Highlight *Change Password* and press OK. Enter your new password.

Using the Features in the Menu System

Setting the Rating Limit

The DVD Limits feature is a rating limit system. It works in conjunction with DVDs that have been assigned a rating—which helps you control the types of DVDs that your family watches.

How to Set DVD Limits

1. Make sure your remote is in DVD mode by pressing the DVD button.
2. If the disc is playing, press STOP. The DVD Player's main menu appears.
3. Press the down arrow button until Lock Player is highlighted. Press OK. The Lock selections appear.
4. Press the down arrow button until DVD Limits is highlighted, and press OK. The DVD rating limits information appears.

Country: Some countries use different rating systems

1. To change the country, press the right arrow button to highlight Country.
2. Press OK. A list of countries appears.
3. Use the up and down arrow buttons on the remote to highlight the country that applies to you. Press OK. The country you selected appears next to the Country path menu.
4. Press CLEAR to return to the main menu or press GO BACK to return to the previous menu screen.

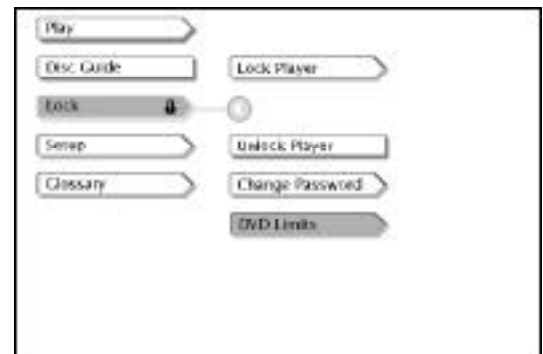

To access the *DVD Limits* settings, highlight *Lock* and press OK. Highlight *DVD Limits* and press OK.



You can change the settings for all of the *DVD Limits* menu items: *Country*, *Rated Titles*, and *Unrated Titles*.



Different countries use different ratings systems. To access the list of countries, highlight *Country* and press OK.

Using the Features in the Menu System

Rated Titles

This part of DVD Limits lets you determine how your player will react to discs that contain movies that are rated (in the U.S.A. the Motion Pictures Association of America rates movies as G, PG, PG-13, etc.).

You decide which ratings require a password and which ones don't. This system ranks the ratings 1 through 8 in order to accommodate different countries' ratings systems (1 is considered a movie title with the least offensive material).

1. Highlight DVD Limits within the Lock menu, and press OK.
2. Press the right and down arrow buttons to highlight Rated Titles and press OK. The 8-level grid with rating limits appears.
3. To change the rating limit, press the up or down arrow button.
 - The ratings that don't require a password (free access) appear in the green part of the block.
 - The ratings that require a password appear in the red part of the block.
4. Press OK. The rating limit appears next to the Rated Titles path menu.
5. Press CLEAR to return to the main menu or press GO BACK to return to the previous menu screen.

Example: If you set PG as the highest rating for Free Access (green), then the Rated Titles selection appears as 3 (that's the player's number for PG in its 8-level system) and PG for the movie studio's rating. This means when the player is locked, it will require you to enter the password to play any discs that are rated higher than PG (i.e., PG13 or R).

Note: If the Rating Limit Feature Doesn't Work

In order for the Rating level feature to work, the disc must be encoded with the proper rating information. If the author of the disc did not encode rating information, then this feature will not work for that disc.

The DVD Player must be locked in order for it to enforce the settings in the *DVD Limits* part of the *Lock* menu.

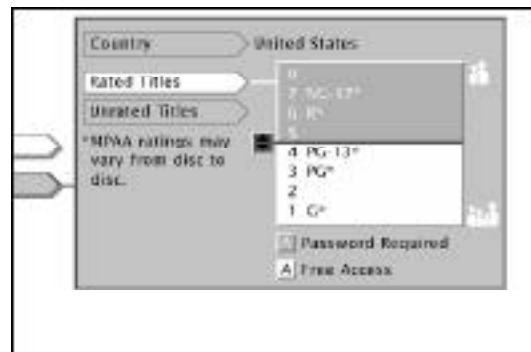

Some titles (movies) are rated and some are not rated. To set the rating limit for rated movies, highlight *Rated Titles* and press OK. Use the up and down arrow keys to the rating level.

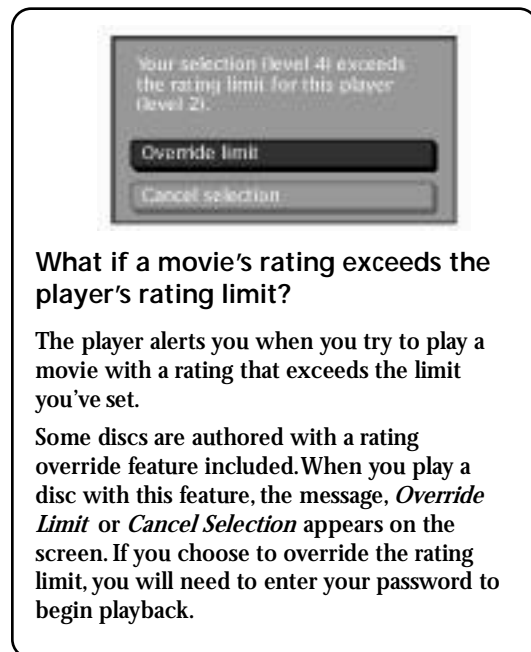

What if a movie's rating exceeds the player's rating limit?

The player alerts you when you try to play a movie with a rating that exceeds the limit you've set.

Some discs are authored with a rating override feature included. When you play a disc with this feature, the message, *Override Limit* or *Cancel Selection* appears on the screen. If you choose to override the rating limit, you will need to enter your password to begin playback.

Using the Features in the Menu System

Unrated Titles:

Some Titles (movies) aren't rated and may contain material that is unsuitable for children. You decide how you want the DVD Limits feature of your player to handle these discs: free access or password required.

To choose the Unrated Titles options:

1. Highlight DVD Limits within the Lock menu, and press OK.
2. Press the down arrow button until Unrated Titles is highlighted.
3. Press OK. The Unrated Titles options appear.
4. Use the up or down arrow button to highlight your choice: Free Access or Password Required. Press OK. The Unrated Titles path, with the choice you made, appears.
5. Press CLEAR to return to the main menu or press GO BACK to return to the previous menu screen.



To change the way your player reacts to unrated movies, highlight *Unrated Titles* within the *DVD Limits* menu. Press OK on the remote. Use the up and down arrow buttons to highlight a selection and press OK.

Using the Setup Menu

Setup contains many options for your DVD Player: language preferences for audio, subtitles, and menus; whether or not you want a disc to play automatically when you put it in the player; the TV image; the Sound setting, the lighting of the front panel display. This section explains each option from top to bottom.

To see the Setup items:

1. From the DVD Player's main menu (player ON, no disc playing), press the down arrow button until Setup is highlighted.
2. Press OK. The Setup selections appear.

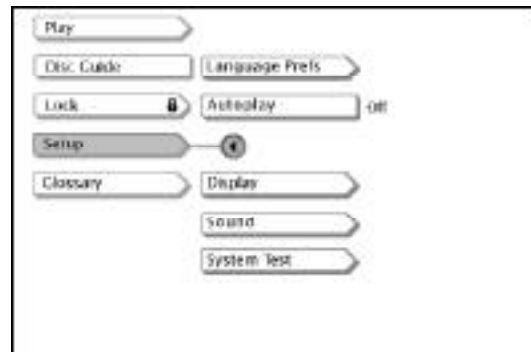

To see the *Setup* menu options, highlight *Setup* in the DVD Player's main menu and press OK.

Language Prefs (preferences)

The Language Prefs (preferences) menu enables you to choose different language options for the audio, subtitles, and the player's menu items.

1. Select the Setup menu within the DVD Player's main menu.
2. Press the up arrow button until Language Prefs is highlighted, and press OK. The language options appear.

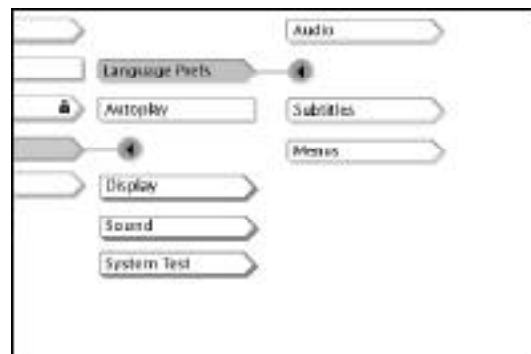

The *Lang Prefs.* menu enables you to choose different language options for the sound, subtitles, and menu items.

Using the Features in the Menu System

Changing the Audio Language Preference

The Audio Language menu enables you to choose which language you want the discs to use.

1. From the Language Prefs menu (within the Setup menu), press the up arrow button to highlight Audio.
2. Press OK. The audio language options appear.
3. Press the up or down arrow button until the language you want to use for the audio portion of each title is highlighted.
4. Press OK. The previous menu appears with your selection shown next to the Audio path menu.
5. Press CLEAR to return to the main menu or press GO BACK to return to the previous menu screen.

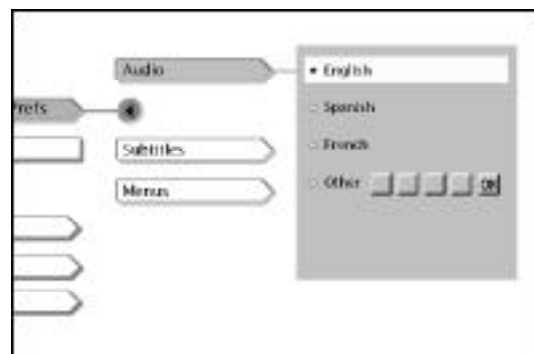

To change the language of the title's audio, select *Audio Language* from the *Lang Prefs* menu. Use the up and down arrow buttons on the remote to choose a language, and press OK.

How to Set *Other* as an Audio Language Option

If the language you want to use isn't listed, select Other.

1. Press the down arrow button to highlight Other. Press OK.
2. Enter the code from the Language Codes list on p. 54.
3. Press OK. The previous menu appears with your selection shown next to the Audio path menu.
4. Press CLEAR to return to the main menu or press GO BACK to return to the previous menu screen.

NOTE:

Remember, your player can't play the disc in the language you have chosen if the disc wasn't created with that language option.

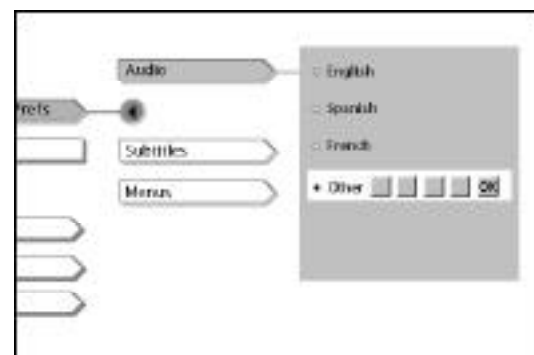

You must enter a code to enter an audio language that isn't listed. Enter the appropriate code from the Language Codes list on p. 54.

Using the Features in the Menu System

Changing the Subtitle Language Preference

The Subtitles menu enables you to choose the language of the subtitles.

1. From the Language Prefs menu (within the Setup menu), press the down arrow button to highlight Subtitles.
2. Press OK. The subtitle options appear.
3. Press the up or down arrow button until the language you want to use for the subtitles of each title is highlighted.
4. Press OK. The previous menu appears with your selection shown next to the Subtitles path menu.
5. Press CLEAR to return to the main menu or press GO BACK to return to the previous menu screen.

Note:

Remember, your player can't play the disc in the language you have chosen if the disc wasn't created with that language option.

How to Set *Other* as a Subtitle Language Option

If the language you want to use isn't listed, select Other.

1. Press the down arrow button to highlight Other. Press OK.
2. Enter the code from the Language Codes list on p. 54.
3. Press OK. The previous menu appears with your selection shown next to the Subtitles path menu.
4. Press CLEAR to return to the main menu or press GO BACK to return to the previous menu screen.

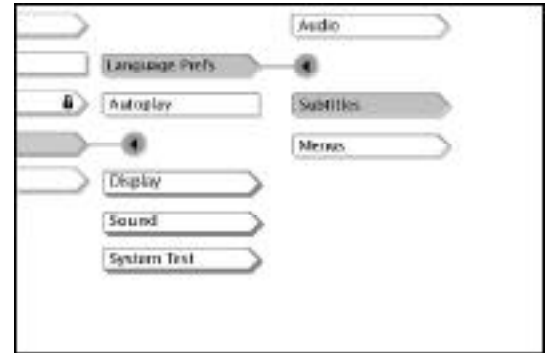

To change the *Subtitles* setting, highlight *Subtitle* and press OK on the remote. Use the up and down arrow buttons to highlight the language you want to use. Press OK.

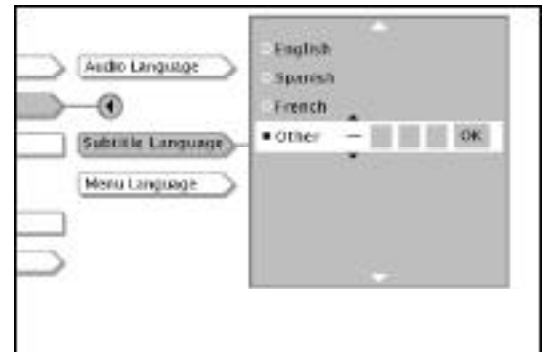

To choose another language, highlight *Other* and enter the code from page 54.

Using the Features in the Menu System

Changing the Menu Language

You can choose one of three languages for the text that appears within the on-screen menu system.

1. From the Language Prefs menu (within the Setup menu), press the down arrow button until Menu is highlighted.
2. Press OK. The language choices for the DVD Player's menu appear.
3. Press the up or down arrow button until the language you want to use for the menu items is highlighted.
4. Press OK. The previous menu appears with your selection shown next to the Menu path menu.
5. Press CLEAR to return to the main menu or press GO BACK to return to the previous menu screen.

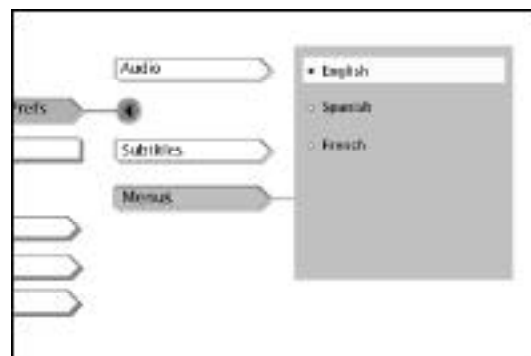

To change the language used in the menu system, highlight *Menu* and press OK on the remote. Use the up and down arrow buttons to highlight the language you want to use. Press OK.

AutoPlay

You can set the AutoPlay menu to play your disc automatically after you close the disc tray.

1. From the DVD Player's main menu (player ON, no disc playing), press the down arrow button until Setup is highlighted. Press OK. The Setup selections appear.
2. Press the up arrow button to highlight AutoPlay. The current setting appears next to the AutoPlay static menu item.
3. Press OK to change the setting from Off to On and vice versa.
4. Press CLEAR to return to the main menu or press GO BACK to return to the previous menu screen.

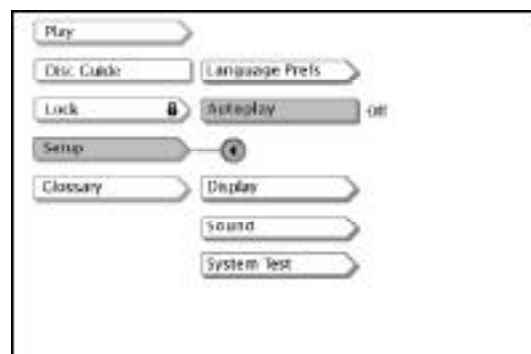

If you want discs to start playing automatically when you close the disc tray, set *AutoPlay* to *On*.

Using the Features in the Menu System

Display

The display menu contains the settings for your TV and the illumination of the front panel.

TV Image

The TV Image menu adjusts the way a movie appears on your TV. Standard TVs are 4 x 3 format. Depending on the type of television you have, you may want to adjust the screen setting (also called, the aspect ratio).

1. From the DVD Player's main menu (player ON, no disc playing), press the down arrow button until Setup is highlighted. Press OK. The Setup selections appear.
2. Press the down arrow button to highlight TV Image. Press OK. The TV Image options appear.
 - 4 x 3 Letterbox: Choose this setting if you would prefer to see movies in their original aspect ratio. You will see the entire frame of the movie, but it will occupy a smaller portion of the screen. This setting may result in the movie appearing with black bars at the top and bottom of the screen.
 - 4 x 3 Standard: Choose this setting if you want the movie to fill the entire screen of your TV. You won't see part of the picture (particularly the right and left edges).
Some discs produced in a widescreen format can't be cropped in this fashion, which means the black bars would appear at the top and the bottom of the screen.
 - 16 x 9 Widescreen: Choose this setting if your DVD Player is connected to a widescreen TV.

If you choose this setting and you don't have a widescreen TV, the images on the screen may appear distorted due to vertical compression.

Note:

If you play a disc recorded in 4 x 3 format on a widescreen TV, the left and right side of the screen will appear black.

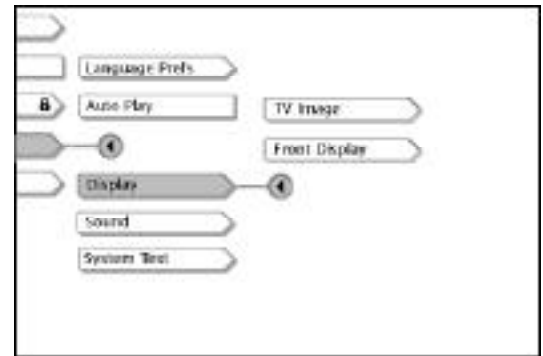

The Display menu contains setting for the TV screen and the front panel display.



To change the TV Image, highlight TV Image and press OK on the remote. Use the up and down arrow buttons to highlight a setting and press OK.

Using the Features in the Menu System

Front Display

This feature enables you to choose how the front panel display on your DVD Player appears.

1. From the DVD Player's main menu (player ON, no disc playing), press the down arrow button until Setup is highlighted. Press OK. The Setup selections appear.
2. Press the down arrow button until Display is highlighted. Press OK. The Display options appear.
3. Press the down arrow button to highlight Front Display. Press OK.
4. Press the up and down arrow buttons to highlight the setting you want to use.
5. Press OK. The previous menu appears with your selection next to the Front Display path menu.
6. Press CLEAR to return to the main menu or press GO BACK to return to the previous menu screen.



You can change the lighting on the front panel of your player by adjusting the *Front Display* menu setting.

Using the Features in the Menu System

Sound

The Sound menu lets you select different sound settings depending on the equipment you have connected to your DVD Player.

1. From the DVD Player's main menu (player ON, no disc playing), press the down arrow button until Setup is highlighted. Press OK. The Setup selections appear.
2. Press the down arrow button until Sound is highlighted. Press OK. The Sound Logic menu and the Audio Equipment menu appear on the screen.

Sound Logic

Sound Logic compresses the dynamic range (quietest sound to loudest sound) of a disc's soundtrack. This feature is useful for late-night listening when you want to hear a movie's dialogue without having to turn up the volume.

1. Press the up arrow button until Sound Logic is highlighted, and press OK. The Sound Logic options appear.
2. Press the up or down arrow button to highlight your selection.
 - Off-No Compression the disc's soundtrack plays exactly as it was authored.
 - Low Compression:Compresses the range of sound the least amount.
 - Medium Compression: Compresses the range of sound a little more than Low Compression
 - High Compression lends the least amount of sound variance.
3. Press OK after you highlight the option you want to use. The previous screen, with your selection listed, appears
4. Press CLEAR to return to the main menu or press GO BACK to return to the previous menu screen.

Note:

The performance of the Sound Logic feature varies depending on the type of equipment you have connected to your DVD Player and the audio format of the disc you're playing.

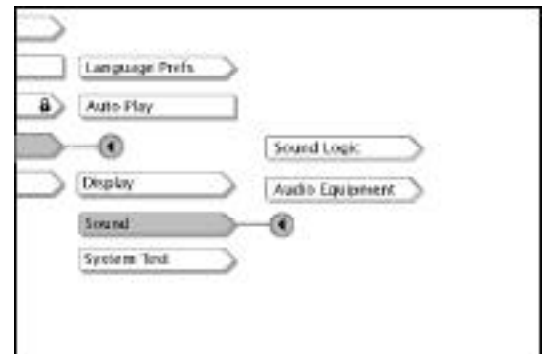

The *Sound* menu contains the *Sound Logic* feature and *Audio Equipment* settings.

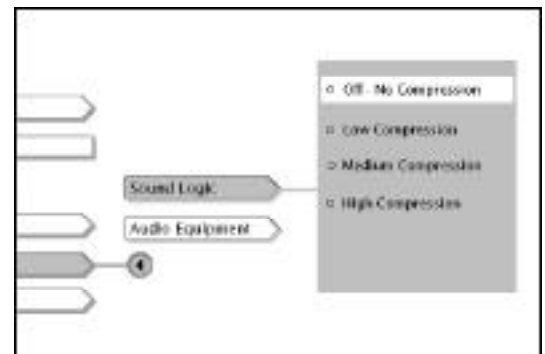

To change the *Sound Logic* setting, highlight *Sound Logic* and press OK on the remote. Use the up and down arrow buttons to change the setting and press OK.

Using the Features in the Menu System

Audio Equipment

If you've connected a Dolby Pro Logic, Dolby Digital, or DTS receiver, you must adjust this setting.

1. From the DVD Player's main menu (player ON, no disc playing), press the down arrow button until Setup is highlighted. Press OK. The Setup selections appear.
2. Press the down arrow button until Sound is highlighted. Press OK. The Sound Logic menu and the Audio Equipment menu appear on the screen.
3. Press the up arrow button to highlight Audio Equipment, and press OK. The Audio Equipment options appear.
4. Use the up or down arrow button to highlight the appropriate selection:
 - PCM: choose this setting for all connection scenarios, except the Dolby Digital or DTS receiver or decoder connection.
 - Dolby Digital: choose this setting if you connected a Dolby Digital receiver or decoder to your DVD Player.
 - DTS: choose this setting if you connected a DTS receiver or decoder to your DVD Player.
5. Press OK after you choose your setting. The previous menu appears with your selection shown next to Digital Output.
6. Press CLEAR to return to the main menu or press GO BACK to return to the previous menu screen.

Note:

You'll find definitions for PCM, DTS, and Dolby Digital in your DVD Player's on-screen glossary. See the Glossary section on the next page for directions.

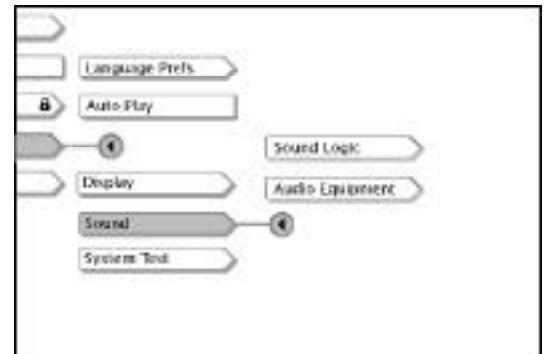

If you inserted an optical digital cable to the DIGITAL AUDIO OUT jack on the back of your player, you must set the *Audio Equipment* setting to *Dolby Digital* or *DTS* to match the brand of receiver you've connected to the DVD Player.

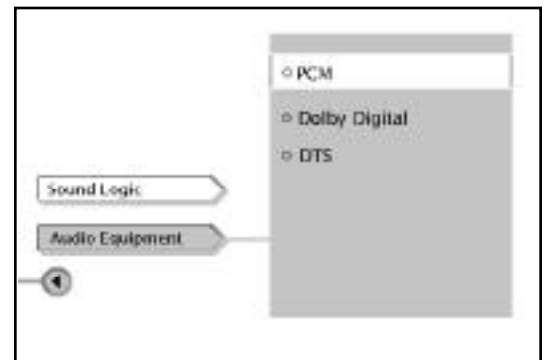

To change the Audio Equipment setting, highlight *Audio Equipment* and press OK on the remote. Highlight the appropriate setting and press OK.

Using the Features in the Menu System

The System Test

The System Test displays information about your DVD Player. The RCA representative may ask you to access this information if you're having trouble with your DVD Player.

1. If a disc is playing, press STOP. The DVD Player's main menu appears. If you're not playing a disc, make sure the player is on, the drawer is closed, and press the DVD button on the remote. The DVD Player's main menu appears.
2. Press down arrow button to highlight Setup and press OK. The Setup selections appear.
3. Press the down arrow button on your remote to highlight System Test and press OK. The System Test information appears.

Note:

The System Test is a diagnostic tool for customer service representatives and doesn't necessarily indicate a problem with your DVD Player.

Important: DTS Information

If you set the *Audio Equipment* menu to *DTS*, you must have your DVD Player connected to a receiver or decoder with the DTS feature and the disc you play must support the DTS audio format. If you choose DTS and your receiver, decoder, or disc doesn't support DTS, you won't hear any audio when you play the disc.

Using the Features in the Menu System

Glossary

The glossary contains information about the features and controls on your DVD Player.

1. Make sure your remote is in DVD mode by pressing the DVD button.
2. If the disc is playing, press STOP. The DVD Player's main menu appears.
3. Press the down arrow button until Glossary is highlighted.
4. Press OK. The Glossary appears.
5. Press the up and down arrow buttons on your remote to highlight different terms. The definitions appear on the right side of the screen.
6. Press CLEAR to return to the DVD Player's main menu.

Some glossary definitions are more than one page. The scroll icon appears in the definition box to let you know when there's a second page.

To see the rest of the definition:

1. Press the right arrow button. The glossary definition is highlighted.
2. Press the down arrow button. The second page of the definition appears.
3. Press the up arrow button to return to the first page of the definition or press GO BACK to return to the terms section of the glossary.

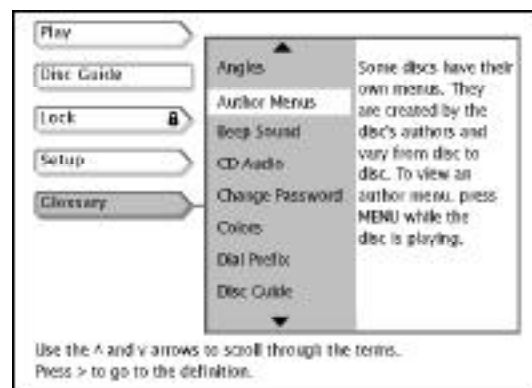

The on-screen glossary contains terms and definitions that might be helpful to you.

Some of the glossary definitions are more than one page. The scroll down icon appears in the definition box to let you know when there's a second page.

To see the rest of the definition:
Press the right arrow button to highlight the definition. Press the down arrow button to see the second page.

Language Codes

Don't forget to press the OK button after you enter the code.

Language	Code	Language	Code	Language	Code
Abkhazian	6566	Hungarian	7285	Russian	8285
Afar	6565	Icelandic	7383	Samoan	8377
Afrikaans	6570	Indonesian	7378	Sangho	8371
Albanian	8381	Interlingua	7365	Sanskrit	8365
Ameharic	6577	Interlingue	7369	Scots Gaelic	7168
Arabic	6582	Inupiak	7375	Serbian	8382
Armenian	7289	Irish	7165	Servo-Croatian	8372
Assamese	6583	Italian	7384	Sesotho	8384
Aymara	6588	Japanese	7465	Setswana	8478
Azerbaijani	6590	Javanese	7487	Shona	8378
Bashkir	6665	Kannada	7578	Sindhi	8368
Basque	6985	Kashmiri	7583	Singhalese	8373
Bengali; Bangla	6678	Kazakh	7575	Siswati	8383
Bhutani	6890	Kinyarwanda	8287	Slovak	8375
Bihari	6672	Kirghiz	7589	Slovenian	8376
Bislama	6673	Kirundi	8278	Somali	8379
Breton	6682	Korean	7579	Spanish	6983
Bulgarian	6671	Kurdish	7585	Sundanese	8385
Burmese	7789	Laothian	7679	Swahili	8387
Byelorussian	6669	Latin	7665	Swedish	8386
Cambodian	7577	Latvian, Lettish	7686	Tagalog	8476
Catalan	6765	Lingala	7678	Tajik	8471
Chinese	9072	Lithuanian	7684	Tamil	8465
Corsican	6779	Macedonian	7775	Tatar	8484
Croatian	7282	Malagsy	7771	Telugu	8469
Czech	6783	Malay	7783	Thai	8472
Danish	6865	Malayalam	7776	Tibetan	6679
Dutch	7876	Maltese	7784	Tigrinya	8473
English	6978	Maori	7773	Tonga	8479
Esperanto	6979	Marathi	7782	Tsonga	8483
Estonian	6984	Moldavian	7779	Turkish	8482
Faroese	7079	Mongolian	7778	Turkmen	8475
Fiji	7074	Naru	7865	Twi	8487
Finnish	7073	Nepali	7869	Ukrainian	8575
French	7082	Norwegian	7879	Urdu	8582
Frisian	7089	Occitan	7967	Uzbek	8590
Galician	7176	Oriya	7982	Vietnamese	8673
Georgian	7565	Oromo (Afan)	7977	Volapük	8679
German	6869	Panjabi	8065	Welsh	6789
Greek	6976	Pashto, Pushto	8083	Wolof	8779
Greenlandic	7576	Persian	7065	Xhosa	8872
Guarani	7178	Polish	8076	Yiddish	7473
Gujarati	7185	Portuguese	8084	Yoruba	8979
Hausa	7265	Quechua	8185	Zulu	9085
Hebrew	7387	Rhaero-Romance	8277		
Hindi	7273	Romanian	8279		

Playing CDs

Just Like Your CD Player

If you've used a CD player, you'll probably notice that your DVD player has many of the same features as a CD player.

This section explains how to play CDs and how to use the on-screen Info Display to access various playback features.

Section Overview:

- **Loading and Playing an Audio CD**
- **Audio CD Playback Features**
 - **Using the Info Display**
 - **Selecting a Track**
 - **Selecting a Play Mode**
 - **Repeat Play**
 - **Using Intro Scan**
 - **Using the Clock**
 - **Using Bookmarks**
- **The Play Menu Items**
 - **Dub Assist**



Playing Audio CDs

Loading and Playing an Audio CD

Before you load a disc, make sure that it is compatible with the player. Note that the following discs CANNOT be used with this player:

- Laserdisc
- CD-I, CD-ROM, CD-R, DVD-ROM
- MiniDisc

To Load and Play an Audio CD

Make sure that you have properly connected the DVD player (see “Setup and Connections”) before you begin.

1. Press OPEN•CLOSE on the front of the DVD player. The disc tray opens.
2. Place a disc gently into the tray with the disc’s label facing up.
3. Press the PLAY button to close the disc tray.

The DVD player reads the disc’s table of contents and the disc starts to play.

4. Press STOP to stop playback.



Insert the CD into your player with the label facing up.

Audio CD Playback Features

When playing audio CDs, your DVD player has many of the same features that your CD player has, including track skip, repeat play, and programmed playback. The on-screen Info Display lets you choose various playback features.

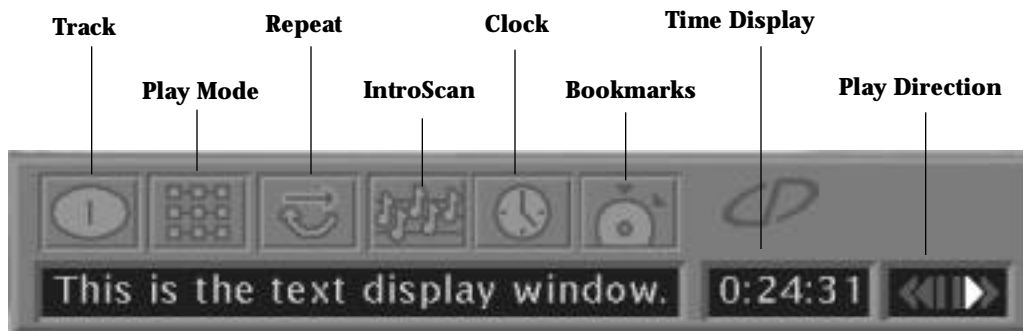

Using the Info Display

To access the Info Display, while the CD is playing, press INFO on the remote. The Info Display appears. Each of the playback features is illustrated with an icon. To access a feature, press the appropriate arrow button on the remote to highlight the icon. Each feature is described on the following pages. To make the Info Display disappear from the screen, press CLEAR on the remote control.

Note:

To see the Info Display, you must turn on your TV and tune it to its Video Input Channel. For more information about the TV's Video Input Channel, see page 13.

Playing Audio CDs



Selecting a Specific Track

1. Press INFO on the remote. The Info Display appears.
2. If necessary, press the arrow buttons to highlight the Track icon.
3. Use the number button(s) on the remote to enter the track number you want to play. You may need to press the OK button on the remote after you enter a single digit, track number.

Scanning Tracks on a CD

While the CD is playing, press CH +. The next track plays.

While the CD is playing, press CH-. The previous track plays.



Selecting a Play Mode

The Play Mode feature lets you set up the order in which you want the tracks on the CD to play. There are three options:

Standard: the tracks play in the order listed on the CD (starting with track 1).

Random: the tracks on the CD play in random order.

Program: the tracks on the CD play in the order that you choose. You create your program playlist in the Play menu of the DVD Player's main menu (this is the menu that appears on the screen when you first turn on the player).

Shortcut: Press PLAY MODE on the remote when a disc is playing.

Scanning an Individual Track

Press FORWARD or REVERSE on the remote while you're playing the CD.

Switching between Standard and Random Play

Standard (the order listed on the CD) is the default setting for your player. To change the setting:

1. Press INFO on the remote while a disc is playing. The Info Display appears.
2. Press the right arrow button until the Play Mode icon is highlighted, and press OK. The Play Mode menu appears.



3. Press the arrow button on the remote to highlight Random, and press OK.
4. Press the down arrow button to highlight Done, and press OK. The Info Display appears on the screen.

Note:

The player defaults to Standard playback whenever you put a new CD into your player.

Playing Audio CDs

Program Playback

To use the Program playback option, you must enter the order in which you want the tracks on the CD to play.

1. Make sure the CD is in the player, but not playing.
2. Make sure Play is highlighted in the DVD Player's main menu and press OK. The Play menu items appears.
3. Press the down arrow button to highlight Edit Program, and press OK. The program menu appears.
4. Use the number buttons on the remote to enter the track you want to play first. The cursor highlights Add.
5. Press OK to add that track into the Program List. The cursor jumps to the Track section.
6. Continue adding tracks as explained in steps 4-5 until your program is complete.
7. To play your program right away, highlight Play and press OK. The tracks on the CD start playing in the order in which you programmed.

If you want to store the program's playlist, press the appropriate arrow button on the remote to highlight Done and press OK.

Note:

To resume normal playback, press GO BACK and then press PLAY.

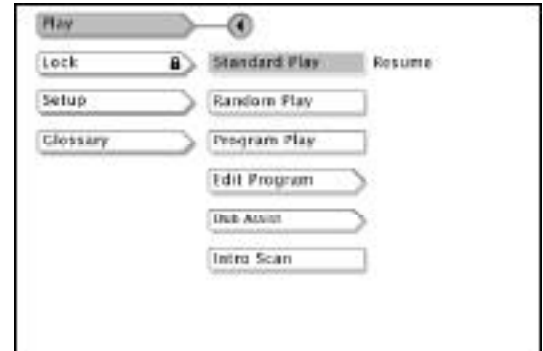

To create a program, go to the *Edit Program* option in the *Play* menu.

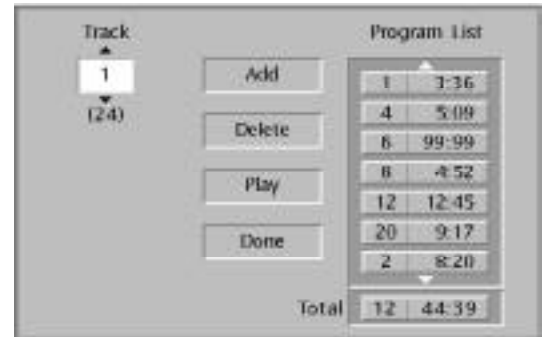

To create your program list, use the number button(s) on the remote to enter a track number. Press OK to add that track to your list.

Deleting and Editing a Program

To edit your program or delete it, go to the DVD Player's main menu, highlight Play, and press OK.

1. Press the down arrow button to highlight Edit Program. Press OK.
2. Press the right arrow button until the Playlist items are highlighted.
3. Use the up and down arrow buttons to highlight the item in the playlist you want to delete.
4. Highlight Delete, and press OK.
5. When you've rearranged the playlist and/or deleted all the tracks necessary. Press OK.

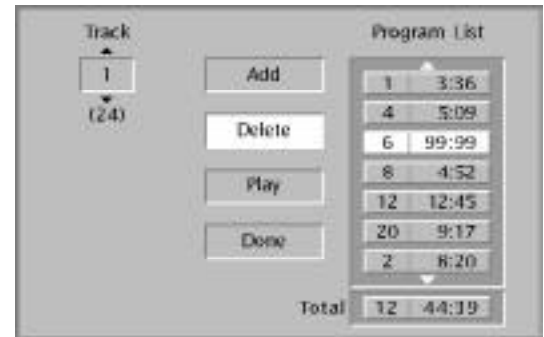

To delete tracks from the *Program List*, use the arrow button to highlight the track. Highlight *Delete* and press OK on the remote.

Playing Audio CDs



Repeat Play

You can tell the player to repeat the entire disc, a track, or you can set A•B repeat.

To repeat the disc or a track:

1. While the CD is playing, press INFO on the remote. The Info Display appears.
2. Press the right arrow button until the Repeat icon is highlighted. Press OK.
3. Highlight the Disc selection or the Track selection.
4. Press OK.
5. Press the down arrow button to highlight Done.
6. Press OK. The player will play the CD or the track over and over again.

Note:

Your repeat settings are erased each time you remove a CD.

Shortcut: Press REPEAT on the remote while a CD is playing.

Cancel Repeat

To cancel Repeat:

1. Press INFO on the remote while the CD is playing.
2. Press the arrow buttons to highlight the Repeat icon and press OK.
3. Press the right arrow button until Off is highlighted. Press OK.
4. Press the down arrow button to highlight Done and press OK.

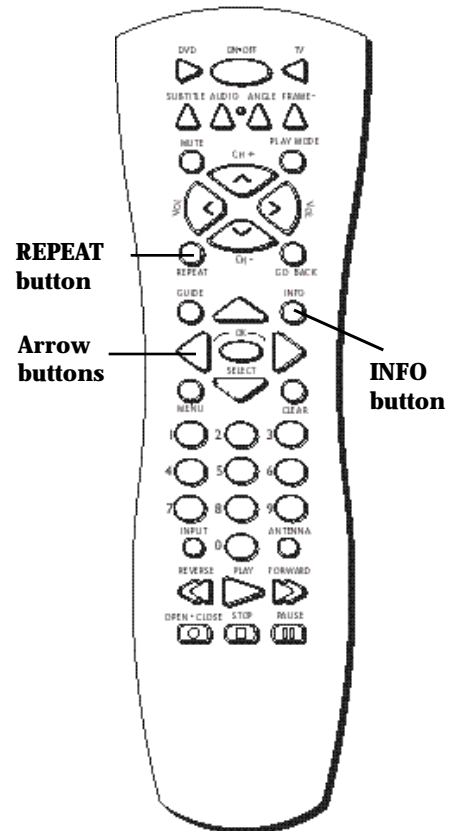

A•B Repeat Deserves Some Extra Instruction

A•B Repeat lets you repeat a specific segment on the CD that you define. For example, if you want to listen to a particular guitar riff within a song, you can set the A•B Repeat to play that part of the song over and over.

1. Press INFO on the remote. The Info Display appears.
2. Press the arrow buttons to highlight the Repeat icon, and press OK. The Repeat menu appears.

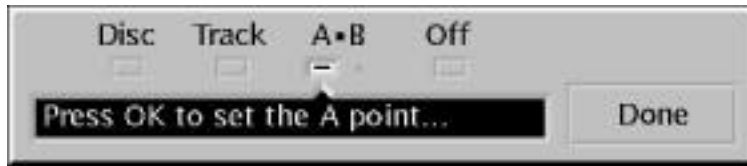

3. Press the arrow button to select A•B. Press OK to set the A point appears on the screen.
4. Press FORWARD or REVERSE on the remote to move to the part of the CD that you want to be the beginning of the segment that is going to repeat (the A point).
5. Press OK.
6. Press FORWARD or REVERSE on the remote to go to the part of the disc that you want to be the end of the segment that will repeat (the B point).
7. Press OK.
8. Press the down arrow to highlight Done and press OK.

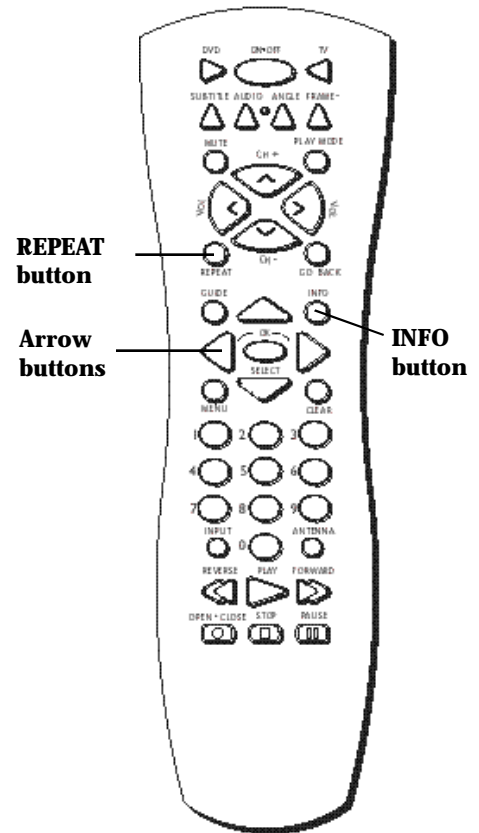

Playing Audio CDs



Using IntroScan

IntroScan plays the first few seconds of each track on the CD—similar to the scan feature that's on many car radios. To use IntroScan:

1. Press INFO on the remote. The Info Display appears.
 2. Press the right arrow button to highlight the IntroScan icon. Press OK. The first few seconds of each track play.
- After IntroScan goes through all of the tracks, it stops.
 - If you want to stop IntroScan while it's in progress, just press PLAY on the remote. The current track starts playing in its entirety.
 - You can also access IntroScan from the Play menu in the DVD Player's main menu.

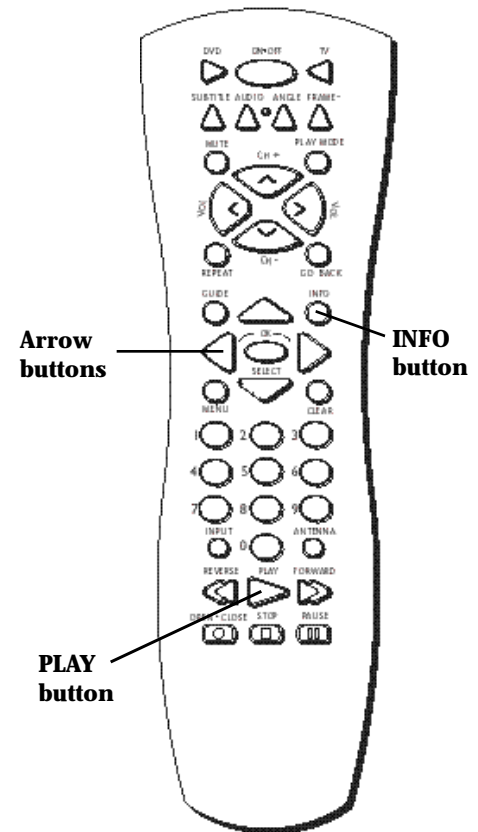

Using the Clock

The Clock part of the Info Display shows you how much time is left and how much time has elapsed.

1. Press INFO on the remote. The Info Display appears.
2. Press the right arrow button to highlight the Clock icon. Press OK. The amount of time the track has played appears in the time window.
3. Repeat steps 1 and 2 each time you'd like to know how much time is remaining in the current track.



The time display



Using Bookmarks

The bookmark feature lets you mark a point on the disc that you can go to quickly. You can store up to 10 bookmarks.

Storing a Bookmark

1. While a disc is playing, press INFO on the remote. The Info Display appears.
2. Use the right arrow button to highlight the Bookmark icon.
3. Press OK. The Bookmark menu appears.



4. When you reach the part of the track that you want to mark, press OK.
5. Press the down arrow button to highlight Done.
6. Press OK.
7. Press CLEAR on the remote to make the Info Display disappear from the screen.

Playing Audio CDs

Recalling a Bookmark

1. While you're playing a disc, press INFO on the remote. The Info Display appears.
2. Press the right arrow button until the Bookmark icon is highlighted.
3. Press OK.
4. Use the up arrow button (and right arrow button if necessary) to select the bookmark.
5. Press OK to activate the bookmark.
6. To return to the Info Display, press the down arrow button until Done is highlighted and press OK.
7. Press CLEAR on the remote to make the Info Display disappear from the screen.

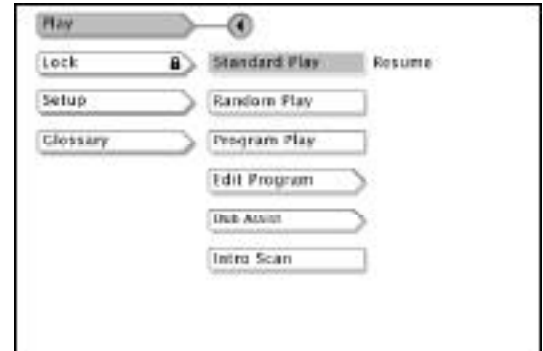

To access the *Play* menu items for your CD, highlight *Play* and press OK.

The Play Menu Items

All of the items in the Play menu (of the DVD Player's main menu), except Dub Assist, have already been explained in the section "Using the Features in the Menu System."

Standard Play: page 58

Random Play: page 58

Edit Program: page 61

IntroScan: page 64

Dub Assist

Dub Assist helps you record a CD onto an audio cassette tape by determining the number of tracks that will fit on one side of the tape so you have time to turn the tape over to record on the other side.

To use Dub Assist when you're recording a CD onto an audio cassette:

1. Press STOP if a CD is playing. The DVD Player's main menu appears.
2. Press the arrow buttons to highlight Play and press OK. The Play options appear.
3. Press the down arrow button until Dub Assist is highlighted and press OK. The Dub Assist screen appears.
4. When the Segment Length box is highlighted, use the up and down arrow buttons to enter the length of one side of the audio cassette.
5. Press the right arrow button to go to the next window and choose Standard, Optimized, or Program.

Standard: This is the default mode. The tracks are recorded in the order on the CD (track 1 is recorded first, track 2 second, etc.)

Optimized: The tracks are recorded in the order that optimizes the number of tracks that can fit on one side of the audio cassette so you have the least amount of dead space between songs.

Program: The tracks are recorded in the order you program. You must create your program in the Edit Program menu that's in the DVD Player's Play menu.

6. After you choose Standard, Optimized, or Program, press OK. The order the tracks will be recorded appears in the Segment box.
7. Press the down arrow button on the remote to highlight Start and press OK.
8. Follow the instructions on the screen to begin recording.

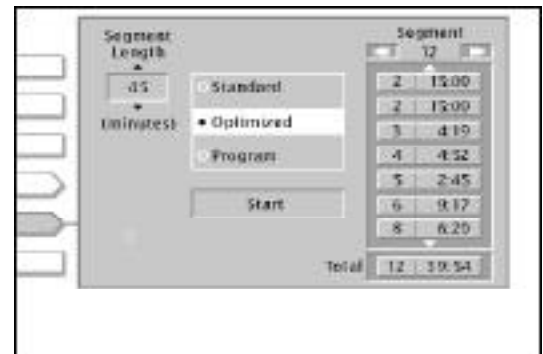

Dub Assist helps you record a CD onto an audio cassette.

Playing Video CDs

What's a Video CD?

The Video CD format is similar to DVD in that Video CDs can contain movies. The big difference is in the amount of information that can be stored on a single Video CD.

This section gives you all the information you need to know to play Video CDs on your DVD player.



Playing Video CDs

Loading and Playing a Video CD

Before you load a disc, make sure that it is compatible with the player. Note that the following discs CANNOT be used with this player:

- Laserdisc
- CD-ROM, CD-R, DVD-ROM
- MiniDisc
- Discs recorded using other color TV systems (i.e. SECAM)

To Load and Play a Video CD

Make sure that you have properly connected the DVD player (see "Setup and Connections") before you begin.

1. Press the OPEN•CLOSE button on the front of the DVD player.
2. Place a disc gently into the tray with the disc's label facing up.
3. Press OPEN•CLOSE or PLAY to close the disc tray.

The DVD player reads the disc's table of contents, and then displays the playback control menu or begins disc playback.

4. Press STOP to stop playback.

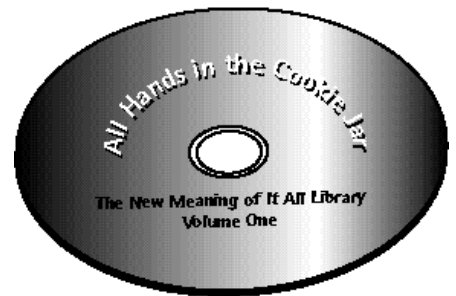

Insert with the label facing up.

Video CD Information Display

1. Press INFO on the remote to bring up the Video CD's information display.
2. Press INFO a second time to turn it off.

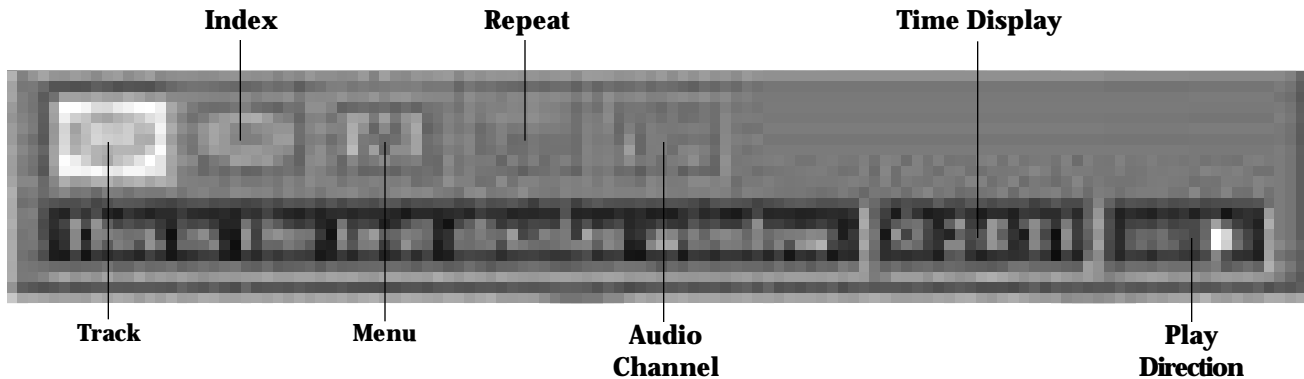

If the Video CD Has Playback Control

If a disc is encoded with the playback control function, a menu screen appears after the disc is loaded into the player.

1. Use the number buttons on the remote to select a title.
2. Press OK or PLAY to begin playback of the selected title.
3. Press CH + or CH - on the remote (SKIP FWD or SKIP REV on the player) to scroll through the titles.
4. Press GO BACK to stop playback and return to the disc menu or press STOP to stop playback and remove the disc menu from the screen.

For More Information About Playback Control

Check the instructions that accompany the Video CD for more information on how to use the playback control function for that specific disc.

Playing Video CDs

Video CD Playback Features

The DVD player gives you several options when playing Video CDs, including skipping tracks and repeat play.

Skipping Tracks

- To skip forward to the beginning of the next track on a Video CD, press CH + on the remote (SKIP FWD on the player).
- To skip backward to the beginning of the track that is playing on a Video CD, press CH - on the remote (SKIP REV on the player). Press the button again to go to the beginning of the preceding track.



Selecting a Specific Track

1. Press INFO on the remote. The Info Display appears.
2. If necessary, press the arrow buttons to highlight the Track icon.
3. Use the number button(s) on the remote to enter the track number you want to play. You may need to press the OK button on the remote after you enter a single digit, track number.



Selecting a Specific Index

1. Press INFO on the remote. The Info Display appears.
2. If necessary, press the arrow buttons to highlight the Index icon.
3. Use the number button(s) on the remote to enter the index number you want to play. You may need to press the OK button on the remote after you enter a single digit index number.



Accessing the Disc Menu

1. Press INFO on the remote. The Info Display appears.
2. If necessary, press the arrow buttons to highlight the Menu icon. The disc menu appears.

Repeat Play

You can tell the player to repeat the entire disc, a track, index or you can set A•B repeat.

To repeat the disc, a track or index:

1. While the Video CD is playing, press INFO on the remote. The Info Display appears.
2. Press the right arrow button until the Repeat icon is highlighted. Press OK.
3. Highlight the Disc selection, Track selection or Index selection.
4. Press OK.
5. Press the down arrow button to highlight Done.
6. Press OK. The player will play the Video CD or the track over and over again.

Note:

Your repeat settings are erased each time you remove a Video CD.

Shortcut: Press REPEAT on the remote while a Video CD is playing.

Cancel Repeat

To cancel Repeat:

1. Press INFO on the remote while the Video CD is playing.
2. Press the arrow buttons to highlight the Repeat icon and press OK.
3. Press the right arrow button until Off is highlighted. Press OK.
4. Press the down arrow button to highlight Done and press OK.

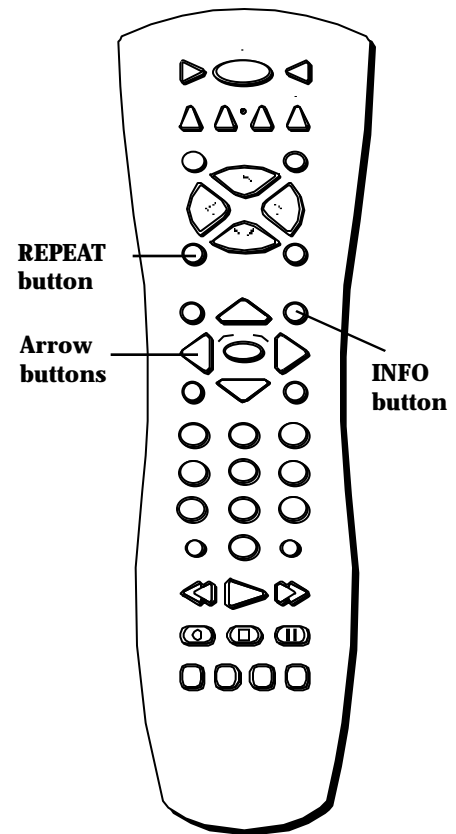

Playing Video CDs

A•B Repeat Deserves Some Extra Instruction

A•B Repeat lets you repeat a specific segment on the Video CD that you define.

1. Press INFO on the remote. The Info Display appears.
2. Press the arrow buttons to highlight the Repeat icon, and press OK. The Repeat menu appears.

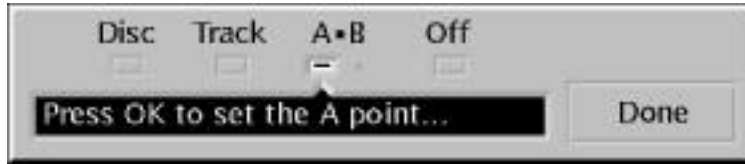

3. Press the arrow button to select A•B. Press OK to set the A point appears on the screen.
4. When the Video CD is at the beginning of the segment that you want to repeat (the A point), press OK.

Note: You can either let the Video CD play until it reaches the A point, or you can use FORWARD or CH + buttons to get to the A point.

5. Go to the end of the segment that you want to repeat (the B point) and press OK.

Note: You can use the FORWARD or CH + buttons to reach the B point, or just let the Video CD play to the B point.

6. Press the down arrow to highlight Done and press OK. The Info Display appears on the screen with the Repeat icon blinking.
7. To make the Info Display disappear from the screen, press CLEAR on the remote.

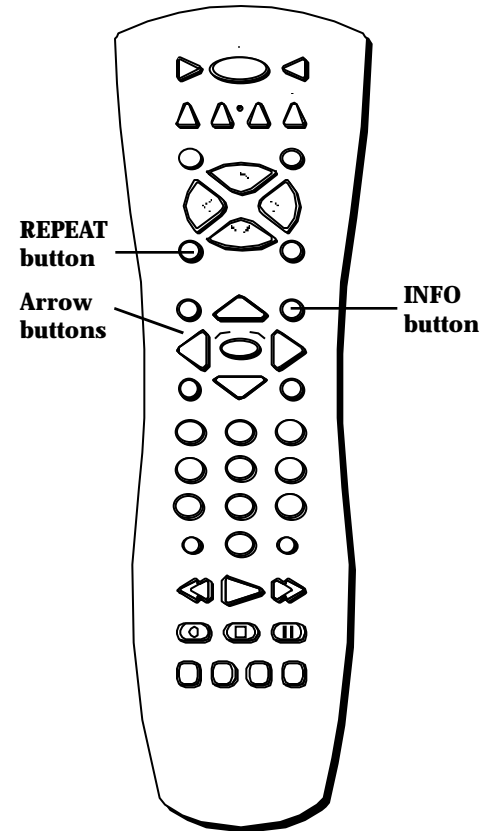

Changing the Audio Channel Output

If you are playing a stereo Video CD, you can change the channel output from the player.

1. Press INFO on the remote.
2. Use the arrow buttons to highlight the Audio Channel icon and press OK.
3. Use the arrow buttons to highlight your Audio Channel choice: Stereo, Left, Right or Mono.
4. Use the arrow buttons to highlight Done and press OK.

Assistance

Section Overview:

Troubleshooting

If you're having any problems with your DVD Player, read the troubleshooting section to find a solution. Troubleshooting is divided into three categories:

- **Common problems**
- **Disc problems**

Care and Maintenance

- **Handling Cautions for the Player**
- **Maintenance of the Cabinet**
- **Formation of Condensation**
- **Cleaning and Handling Discs**

Limited Warranty

The Limited Warranty includes information on getting service for your DVD Player.

Assistance Section

How to Resolve Product Performance Problems

If you are experiencing product operation problems, please review the troubleshooting section before you call for service. Please refer to the Limited Warranty (p. 82) for information on how to obtain repair service.

Player Performance Problem?

1. Review troubleshooting (pp. 78-80)
2. For other problems, refer to the Limited Warranty for service information.

Troubleshooting

Common Problems	Solutions
Player won't work	Reset the DVD Player by unplugging the AC power cord and plugging it back in.
No Power	Plug in the DVD Player. Make sure both ends of the AC power cord are securely plugged into the player and into an AC outlet.
Power turns itself off	The power is automatically turned off after the player has been stopped for approximately 30 minutes (auto power-off feature). Turn power back on.
Disc won't play	<ul style="list-style-type: none">• Insert a disc with the label side facing up.• Check the type of disc you put into the player. This player only plays DVD discs and audio CDs.
Play starts, but then stops immediately	<ul style="list-style-type: none">• The disc is dirty. Clean it.• Condensation has formed. Allow player to dry out.
No picture	<ul style="list-style-type: none">• Turn your TV to its Video Input Channel (see p. 13).• Turn on the TV.• Make sure your player is connected properly.
No sound or distorted sound	<ul style="list-style-type: none">• Make sure your player is connected properly. Make sure all cables are securely inserted into the appropriate jacks.• You may need to readjust the setting in the Audio Equipment menu (it is in the Sound menu within the Setup menu). Set it to PCM unless you have connected a Dolby Digital or DTS receiver (or decoder) to your DVD Player. See page 53.• Turn your TV to its Video Input Channel (see p. 13).• Sound is muted during still, frame advance, or slow-motion play.• If you connected an audio receiver to your DVD Player, make sure you choose the correct input setting on the receiver.

Troubleshooting

Common Problems	Solutions
Remote control won't work	<ul style="list-style-type: none"> • You might be in the wrong mode. To operate your DVD Player, press DVD on the remote before you press any other buttons. If you're operating the TV, press the TV button first, etc. • Insert new batteries in the remote. • Operate the remote control at a distance of no more than 20 feet. • Remove any obstacles between the remote and the DVD Player or other component. If your DVD Player is in an entertainment cabinet, the glass doors may be obstructing the remote control from operating the unit. Open the doors. • Reset the remote. Remove batteries and hold down one or more buttons for several minutes to drain the microprocessor inside the remote to reset it. Reinstall batteries and try the remote again.
Can't advance through a movie	<ul style="list-style-type: none"> • You can't advance through the opening credits and warning information that appear at the beginning of movies because the disc is programmed to prohibit that action.
The  icon appears on screen	<ul style="list-style-type: none"> • The feature or action cannot be completed at this time because: <ol style="list-style-type: none"> 1. The disc's software restricts it. 2. The disc's software doesn't support the feature (e.g., angles). 3. The feature is not available at the moment 4. You've requested a title or chapter number that is out of range.
The picture is distorted	<ul style="list-style-type: none"> • Did you connect your VCR to the DVD Player? Disconnect it. • The disc might be damaged. Try another disc.
Picture is distorted during forward and reverse scan	It is normal for some distortion to appear while scanning.
A screen saver appears on the TV	<ul style="list-style-type: none"> • Your player is equipped with a screen saver (the RCA logo) that appears on the TV when your player is idle for several minutes. There are a few ways to make the screen saver disappear from the screen and return to the player's main menu: press STOP, CLEAR, or GO BACK on the remote.

(continued on the next page)

Assistance Section

Troubleshooting

Common Problems	Solutions
Subtitle and/or audio language is not the one selected from the initial setting	If the subtitle and/or audio language does not exist on the disc, the initial settings will not be seen/heard. The disc's priority language is selected instead. Set the subtitle and/or audio language manually through the Info Display.
The menu is displayed in a foreign language	The Menu Language preference is set to that language. Go to Language Prefs in Setup menu and select the language you prefer. See p. 47.
Play doesn't begin when you press PLAY	The rating of the title on the disc exceeds the rating limit set in the DVD Limits Divx Limits menu. Unlock the player or change the rating limit in those menus.
No forward or reverse scan	<ul style="list-style-type: none">• Some discs have sections that prohibit rapid scanning, or title and chapter skip.• If you're trying to skip through the credits warning information at the beginning of a movie, you won't be able to. This part of the title (movie) is often programmed to prohibit skipping through it.
Disc won't play	Both the player and the disc are coded by region. If the regional codes don't match, the disc cannot be played. This player is Region No. 1.
Desired angle cannot be changed	Some discs don't have the multi-camera angle system, and some discs only have it in certain parts of the movie.
Picture has wrong aspect ratio	Change the TV Image setting in the Setup menu. See p. 48.
I forget the password	Your player is equipped with a "back-door" unlock sequence. Press and hold the STOP button on the front of the DVD Player and the STOP button on the remote control at the same time. (Hold both buttons down at the same time for at least 3 seconds).
Cannot copy discs to video tape	You can't record digital video discs onto videocassettes because the discs are encoded with anti-copy protection.
Disc tray won't open	Disengage the dealer tray lock feature. Press and hold a combination of buttons on the front panel at the same time. Press and hold STOP, ON•OFF, and OPEN•CLOSE for at least three seconds.
Disc won't eject	When you put a disc into the player, the player reads the disc which may take up to 15 seconds. You won't be able to eject the disc during this time. Wait 15 seconds and try again.

Handling Cautions

- Before connecting other components to this player, be sure to turn them all off.
- Do not move the player while a disc is being played, or the disc may be scratched or broken, and the player's internal parts may be damaged.
- Do not put a flower vase filled with water or any small metal objects on the player.
- Be careful not to put your hand into the disc tray.
- Do not place anything other than the disc in the disc tray.
- Exterior influences such as lightning and static electricity can affect normal operation of this player. If this occurs, turn the player off and on again with the ON•OFF button, or disconnect and then reconnect the AC power cord to the AC power outlet. The player will operate normally.
- Be sure to remove the disc and turn off the player after use.

Maintenance of Cabinet

For safety reasons, be sure to disconnect the AC power cord from the AC outlet.

- Do not use benzene, thinner, or other solvents for cleaning.
- Wipe the cabinet with a soft cloth.

Formation of Condensation

Due to sharp changes in temperature and humidity, condensation may form if warm air comes in contact with any cold parts inside the player.

- When condensation forms inside the player, the player may not operate correctly. If this occurs, leave the player at room temperature until the inside of the player becomes dry and operational.
- If condensation forms on a disc, wipe the disc with a soft and dry cloth by moving the cloth from the center hole toward the outer edge.

Handling Discs

- Do not touch their signal surfaces. Hold by the edges or by one edge and the hole in the center.
- Do not affix labels or adhesive tape to label surfaces. Also, do not scratch or damage the label.
- Discs rotate at high speeds inside the player. Do not use damaged (cracked or warped) discs.

Cleaning Discs

- Dirty discs can cause reduced video and audio performance. Always keep discs clean by wiping them gently with a soft cloth from the inner edge toward the outer perimeter.
- If a disc becomes very dirty, wet a soft cloth in water, wring it out well. Wipe the dirt away gently, and remove any water drops with a dry cloth.
- Do not use record cleaning sprays or anti-static agents on discs. Also, never clean the discs with benzene, thinner, or other volatile solvents which may cause damage to the disc surface.

Assistance Section

How to Resolve Product Performance Problems

If you are experiencing product operation problems, please review the troubleshooting section before you call for service. Please refer to the Limited Warranty (see below) for information on how to obtain repair service.

Limited Warranty RCA Digital Video Disc (DVD) Player

What your warranty covers:

- Any defect in materials or workmanship.

For how long after your purchase:

- 90 days - Unit exchange, which includes parts and labor.
- 91 days to 1 year - Unit exchange, which includes parts only; you pay the labor.
- The warranty for rental units begins with the first rental or 45 days from date of shipment to the rental firm, whichever comes first.

What we will do:

During the initial 90 days:

Exchange the DVD unit with a new or, at our option, refurbished unit.

After the 90 days and within one year:

Exchange the DVD unit with a new or, at our option, refurbished unit. We will bill you a flat exchange charge to replace a defective unit. This charge covers the labor cost for its repair.

How you get service:

- Call 1-800-311-9263 and have your unit's date of purchase and model/serial number ready. The model/serial number information is on the back of your unit.
- A representative will troubleshoot your problem over the phone.
- If the representative determines that you should receive a replacement unit you will be provided with a Return Authorization (RA) number and the location of a nearby exchange point if one exists. No returns will be accepted without the RA number.

To receive a replacement unit before you return yours:

Option I:

1. Provide your Discover, Mastercard or Visa account number and expiration date to your phone representative. This is for security purposes only and your account will not be charged at this time.
2. We will send you a replacement unit.
3. If you return the unit to us within 14 days from the date you were provided a RA number, only items not covered by warranty will be charged to your account. If your unit is not received within 14 days, the suggested retail value of the receiver will be charged to your credit card. This amount will be credited, less a \$10 handling fee, if the unit is subsequently received.
4. Ship your defective unit back to us using the replacement unit's carton. Shipping instructions will be included on the carton along with your RA number which will allow you to easily ship the unit back to us. Make sure you insure your shipment in case of damage or loss. Include with the shipment:
 - Evidence of purchase date such as a bill of sale.
 - A brief note describing your unit's problem.
 - Your name, address and phone number.

Option II:

1. We will send a replacement unit to our exchange point.
2. The exchange location will notify you of its arrival.
3. Take your unit and evidence of purchase date, such as a bill of sale, to the exchange location and you will be provided the new or refurbished unit. Please retain all accessories such as the remote control hand unit.
4. If the repairs are covered by your warranty, you will not be billed.

Thomson assumes no responsibility for warranty shipments from the customer to the factory if not shipped in the manner prescribed by Thomson.

Return transportation, storage, handling and insurance costs are your responsibility. We accept no responsibility in case of damage or loss.

To receive a replacement unit after we have received your unit:

- Write the RA number on the outside of the carton used to return the unit. Make sure you insure your shipment in case of damage or loss.
- Carefully pack the unit using the original box and packing material if possible. Please retain all accessories that were included with your unit such as the remote control hand unit.
- Include with the shipment:
 1. Evidence of purchase date, such as a bill of sale, to verify your unit's warranty eligibility.
 2. A brief note describing your unit's problem.
 3. Your name, address and phone number.
- The representative will advise the address to mail a cashier's check or money order for payment if there are any out of warranty labor or parts charges, and you elect not to use your credit card.
- After we receive your product, a new or refurbished unit will be shipped to you.

What your warranty does not cover:

- Acts of God, such as but not limited to lightning damage.
- Adjustment of customer controls.
- Damage from misuse or neglect.
- A unit that has been modified or incorporated into other products or is used for institutional or other commercial purposes.
- Batteries.
- Units purchased or serviced outside the U.S.A.
- Shipping damage if the unit was not packed and shipped in the manner prescribed by Thomson.
- Storage fees may be charged by the exchange point if you fail to pickup the replacement unit in a timely manner.

Product Registration:

- Please complete and mail the Product Registration Card packed with your DVD product. It will make it easier to contact you should it ever be necessary. The return of the card is not required for a warranty coverage.

How state law relates to warranty:

- This warranty gives you specific legal rights and you may have other rights that vary from state to state.

If you purchased your product outside the United States:

- This warranty does not apply. See your dealer for warranty information.

Reference

Section Overview:

About the DVD Player

- **Description of the front panel**
- **Description of front panel display lights**
- **Basic use and care guidelines**

Programming the Remote

This section describes how to program the remote control your television. The remote automatically operates most RCA, GE, and PROSCAN televisions.

Detailed information about the remote control buttons is in the Setup and Connections section (pp. 14-17).

Accessories

The Accessories section lists some extra things you might want to order to use with your DVD Player. You can send in the form or call the 800-number listed.

Index

Front Panel Controls

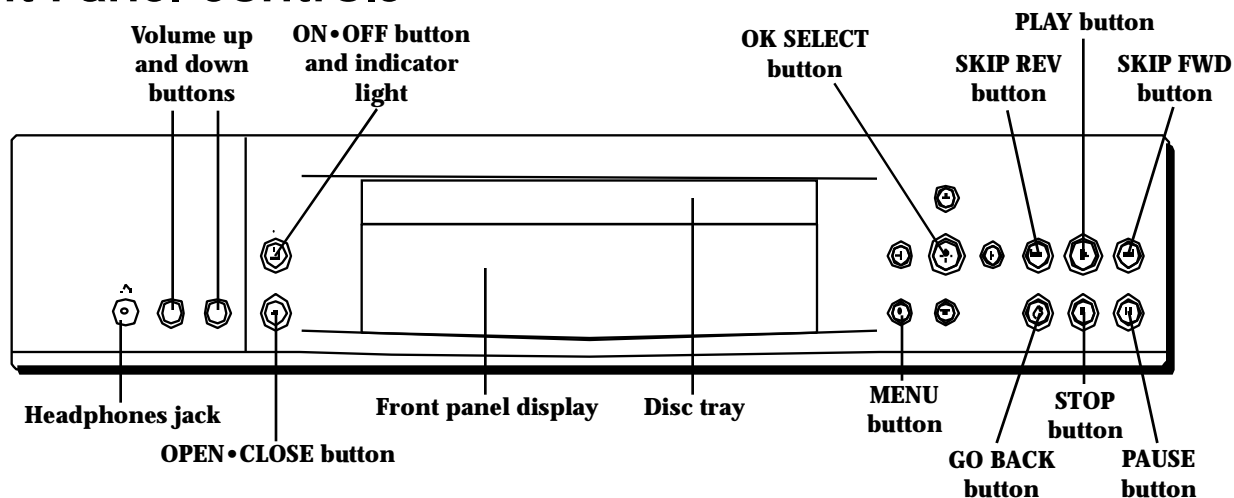

Arrow buttons (up, right, down, left) Use these buttons to move through the DVD Player's on-screen menu system

Disc tray Press OPEN•CLOSE to open and close the disc tray.

Front panel display (See following page for details.)

GO BACK Press to go back one level in the menu system.

Headphones jack You can attach headphones here for private listening.

MENU Press to access the main DVD Player menu.

OK SELECT Press this button to select a highlighted item on the screen.

ON•OFF button and ON•OFF indicator light Turns the player on and off. The ON•OFF indicator lights when the player is on.

OPEN•CLOSE Press to open and close the disc tray.

PAUSE Pauses disc play (also used for frame advance).

PLAY Begins disc play (and closes disc tray if open).

SKIP FWD Allows you to move to the beginning of the next title, chapter, or track on a disc (in effect, "skipping" the title, chapter, or track).

SKIP REV Allows you to move to the beginning of the preceding title, chapter, or track on a disc (in effect, "skipping" the title, chapter, or track).

STOP Stops disc play.

VOLUME (+ and -) Adjusts the headphone, volume level.

Front Panel Display

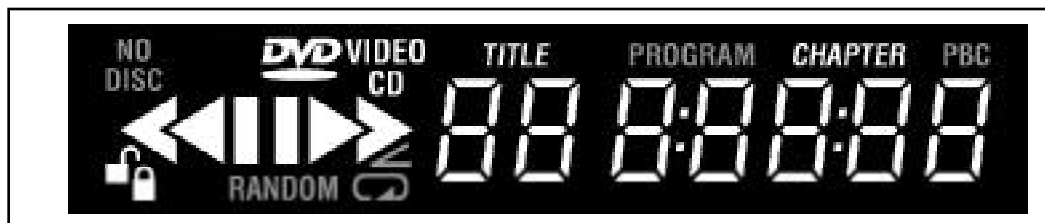

Display lights listed from left to right (top row first)

1. **NO DISC** There isn't a disc in the disc tray.
2. **DVD** Lights when you play a DVD disc.
3. **VIDEO** Not applicable.
4. **CD** Lights when you play an audio CD.
5. **TITLE** Indicates the title that is playing.
6. **PROGRAM** The disc is playing the chapters (or tracks) in the order you programmed.
7. **CHAPTER** Indicates the chapter that is playing.
8. **PBC** Not applicable.
9. **Play direction** Indicates whether the disc is paused, moving forward, or backward.
10. **The display.** The display messages are:
 - OFF** Displayed when you turn off the player.
 - HELLO** Displayed when you first turn on the player.
11. **Unlocked** Indicates the player is unlocked (no password required to play discs).
12. **Locked** Player is locked. You must enter password to play discs with rating limits higher than those you entered in the Ratings menu.
13. **RANDOM** The disc is playing the chapters (or tracks) in random order.
14. **Angle** Indicates that the angle feature is available.
15. **Repeat** Indicates that the Repeat feature has been activated.

Reference

Programming the Remote

The remote can be programmed to control most brands of remote controllable TVs. The remote is already programmed to control most RCA, PROSCAN, and GE TVs.

Testing the remote

To determine whether the remote needs to be programmed, turn the TV ON, point the remote at the TV, and press the TV button. Then press POWER or CH ^ (channel up) or CH v (channel down) to see if the TV responds to the remote commands. If not, the remote needs to be programmed.

Programming the remote

There are two ways to program the remote control: automatic code search and direct entry.

Using Automatic Code Search

The following instructions can be used to program the remote to operate your television. If you want to exit the automatic code search without programming the TV, press CLEAR until the red light on the remote turns off.

1. Turn on the TV you want to operate.
2. Press and hold the TV button you want to program. While holding the TV button, press and hold ON•OFF until the red light on the remote turns on, then release both buttons.
3. Point the remote at the TV. Press and release PLAY, then wait 5 seconds or until the red light on the remote stops flashing.

At this point the remote is searching for the correct code to program. If, after 5 seconds, the TV you want to operate does not turn off, press PLAY again to tell the remote to search the next set of codes.

Continue pressing PLAY until the TV turns off or you have searched through all of the codes. There are 20 total sets of codes. If the TV does not turn off after pressing PLAY 20 times, then the remote cannot be programmed to operate that TV.

If the TV you want to control does turn off:

1. Press and release REVERSE, then wait 2 seconds. Repeat this step until the TV turns back ON.
2. To finish, press and hold STOP until the red light on the remote turns off.

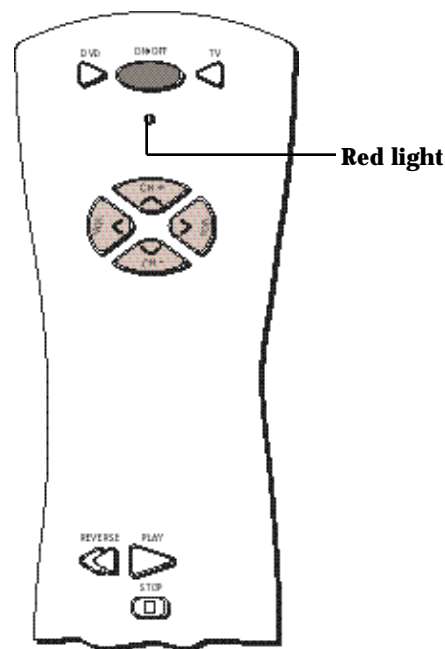

You'll use these buttons when you program the remote to operate a television. The remote may not operate all models of all brands.

Using Direct Entry

1. Turn on the TV to be programmed.
2. Look up the brand and code number(s) for the TV on the code list in this section.
3. Point the DVD Player's remote at the TV.
4. Press and hold the TV button on the remote you want to program.
5. Enter the code from the Remote Control code list (pp. 88).
6. Release the TV button, and then press ON•OFF to see if the TV responds to the command. If it doesn't, try pressing the TV button and then ON•OFF again.
7. If you get no response, repeat these steps using the next code listed for your brand, until the TV responds to the remote commands.

Note:

This remote may not be compatible with all brands and models of televisions

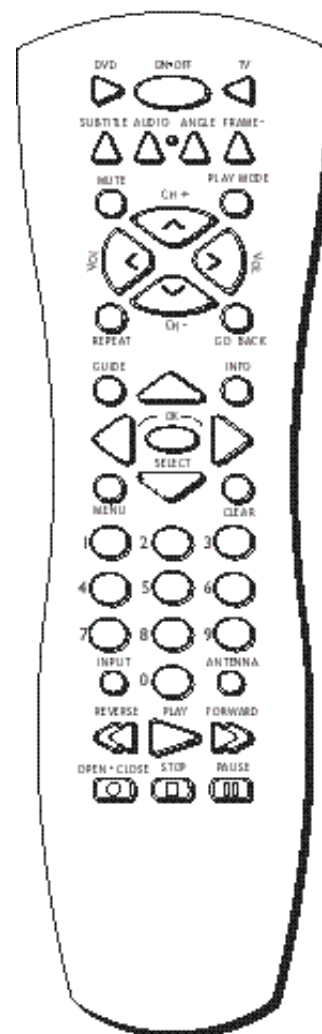

This Is Important!

You must *continue pressing* the TV button *while* you enter the code.

Let's say you have a Zenith TV. To program the remote to operate the TV you would:

Press and hold the TV button while you enter the first code listed for Zenith in the TV Codes column.

Release the TV button. Press ON•OFF to see if the TV responds. If it doesn't, follow the same steps, but enter the second code instead of the first.

Remote Control Code List

TV Codes

Abex	1172	Lxi	1000, 1006, 1049,	Symphonic	1033, 1038
Admiral	1001	1062, 1071, 1072, 1073, 1162, 1181	Tatung	1003
Aiko	1016	Magnavox	1004, 1006, 1008, 1019, 1062,	Technics	1054
Alleron	1046	1068, 1069, 1074, 1075, 1076, 1077, 1088,	Techwood	1004, 1006, 1054
Amtron	1038	1089, 1130, 1131, 1132, 1133, 1134, 1183, 1184	Teknika	1004, 1005, 1006, 1008, 1012, 1013, 1016,
Akai	1002	Marantz	1062	1038, 1046, 1076, 1082, 1083, 1105, 1170, 1171
Anam National	1003, 1038	Marantz	1004, 1006, 1062	Telecaption	1117
AOC	1004, 1005, 1006, 1007	Megatron	1006, 1059	TMK	1004, 1006
Audiovox	1038	Memorex	1001, 1006, 1082, 1162	Toshiba	1049, 1071, 1072, 1089,
Belcor	1004	MGA	1004, 1005, 1006, 1019,	1105, 1109, 1117, 1118, 1160, 1162
Bell & Howell	1001, 1162	1022, 1051, 1079, 1080, 1082	Totevision	1171
Bradford	1038	Midland	1054, 1151, 1171, 1172, 1181	Universal	1052, 1087
Brokwood	1004	Minutz	1052	Victor	1066,
Candle	1004, 1006, 1008	Mitsubishi	1004, 1005, 1006, 1019, 1022,	Vidtech	1004, 1005, 1006
Celebrity	1002	1051, 1079, 1080, 1081, 1082, 1125	Wards	1000, 1001, 1004, 1005, 1006, 1019, 1024,
Citizen	1004, 1006, 1008, 1016, 1038, 1105, 1171	Motorola	1003	1033, 1046, 1052, 1062, 1069, 1074, 1075,
Colorlyme	1004, 1006	MTC	1004, 1005, 1006, 1105	1076, 1083, 1087, 1088, 1095, 1119, 1120, 1184
Concerto	1004, 1006	Multitech	1038	Yamaha	1004, 1005, 1006, 1019
Contec/Cony	1012, 1013, 1014, 1038	Multivision	1084	Zenith	1004, 1151, 1152, 1153, 1154
Craig	1038	NAD	1006, 1071, 1072		
Crown	1038, 1171	NEC	1003, 1004, 1005, 1006, 1089		
Curtis Mathes	1000, 1004, 1006,	Nikko	1006, 1016		
.....	1015, 1105, 1162, 1171	NTC	1016		
CXC	1038	Onwa	1038		
Daewoo	1004, 1005, 1006,	Orion	1035		
.....	1016, 1017, 1018, 1127, 1171	Panasonic	1003, 1054, 1062, 1170		
Daytron	1004, 1006, 1171	Philco	1003, 1004, 1005, 1006, 1008, 1012, 1019,		
Dimensia	1000	1062, 1068, 1069, 1074, 1075, 1077, 1183, 1184		
Dumont	1004, 1151	Philips	1003, 1004, 1008, 1012, 1019, 1062, 1068,		
Electroband	1002	1069, 1074, 1075, 1076, 1086, 1087, 1088, 1089		
Electrohome	1003, 1004, 1006, 1019, 1022	Pilot	1004, 1171		
Emerson	1004, 1006, 1012, 1024,	Pioneer	1004, 1006, 1090, 1091, 1092, 1179		
.....	1025, 1026, 1027, 1028, 1029,	Portland	1004, 1005, 1006, 1016, 1171		
.....	1030, 1031, 1032, 1033, 1034, 1035,	Price Club	1105		
.....	1036, 1037, 1038, 1039, 1041, 1042, 1043,	Prism	1054		
.....	1044, 1046, 1047, 1123, 1124, 1162, 1171, 1179	PROSCAN	1000, 1181		
Envision	1004, 1006	Proton	1004, 1006, 1012		
Fisher	1048, 1049, 1050, 1051, 1162, 1180	Pulsar	1151		
Fujitsu	1046	Pulser	1004		
Funai	1038, 1046	Quasar	1003, 1054, 1070, 1094		
Futuretec	1038	Radio Shack/Realistic	1000, 1004, 1006,		
GE	1000, 1003, 1004, 1006,	1012, 1038, 1049, 1162, 1171, 1172		
.....	1022, 1052, 1054, 1055, 1087,	RCA	1000, 1003, 1004, 1005, 1006, 1007,		
.....	1164, 1165, 1166, 1167, 1168, 1181	1019, 1096, 1098, 1099, 1100, 1101, 1102		
Gibraltar	1004, 1151	1103, 1129, 1179, 1181, 1187, 1188, 1190		
Goldstar	1004, 1005, 1006, 1012, 1019,	Runco	1151		
.....	1056, 1057, 1058, 1155, 1156, 1171, 1172	Sampo	1004, 1006, 1171, 1172		
Grundy	1038, 1046, 1171	Samsung	1004, 1005, 1006, 1012,		
Hallmark	1004, 1006	1015, 1019, 1104, 1105, 1106, 1171, 1172		
Harvard	1038	Samsux	1171		
Hitachi	1004, 1006, 1012, 1013,	Sanyo	1004, 1048, 1049, 1050,		
.....	1059, 1060, 1061, 1135, 1136,	1080, 1107, 1108, 1162, 1180		
.....	1137, 1138, 1139, 1140, 1141, 1142,	Scotch	1006		
.....	1143, 1144, 1145, 1146, 1148, 1150, 1179	Scott	1004, 1006, 1012, 1024, 1035, 1038, 1046		
IMA	1038	Sears	1000, 1004, 1006, 1013, 1019,		
Infinity	1062	1046, 1048, 1049, 1050, 1051, 1066,		
JBL	1062	1071, 1072, 1109, 1110, 1162, 1180, 1181		
JCB	1002	Sharp	1004, 1006, 1012,		
JC Penny	1000, 1004, 1005, 1006, 1008,	1029, 1111, 1112, 1113, 1122, 1171		
.....	1022, 1052, 1054, 1058, 1063, 1064,	Shogun	1004		
.....	1072, 1087, 1105, 1128, 1171, 1172, 1181	Signature	1001, 1115		
Jensen	1004, 1006	Simpson	1008		
JVC	1012, 1013, 1054, 1060, 1065,	Sony	1002		
.....	1066, 1067, 1089, 1157, 1158, 1159	Soundesign	1004, 1006, 1008, 1038, 1046		
Kawasho	1002, 1004, 1006	SSS	1004, 1038		
Kenwood	1004, 1006, 1019	Starlite	1038		
Kloss Novabeam	1068, 1069, 1183	Supreme	1002		
KTV	1038, 1070, 1171	Sylvania	1004, 1006, 1008,		
Loewe	1062	1019, 1062, 1068, 1069, 1074, 1075,		
Luxman	1004, 1006	1076, 1077, 1088, 1116, 1161, 1183, 1184		



Optical Plug to Optical Plug DV3 (3 ft.) DV6 (6 ft.)



Optical Plug to Mini Plug DV3M (3 ft.) DV6M (6 ft.)



**RF Output Adapter
(CRF 800)**

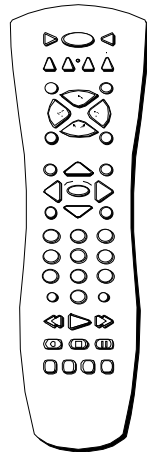
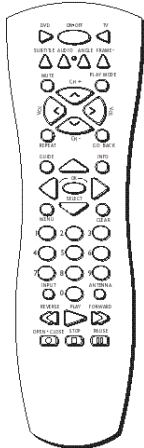

**Universal Remote
Control (CRK76DA1)**

Accessory Order Form for Your DVD Player

Description	Part No.	Price	Qty
Optical Plug to Optical Plug (3 ft.)	DV3	\$29.95	
Optical Plug to Optical Plug (6 ft.)	DV6	\$39.95	
Optical Plug to Mini Plug (3 ft.)	DV3M	\$29.95	
Optical Plug to Mini Plug (6 ft.)	DV6M	\$39.95	
RF Output Adapter	CRF 800	\$39.95	
Remote Control (CRK76DD1)	244157	\$28.65	
Remote Control (CRK76DA1)	240897	\$28.65	
Surge Protector	SCTV160	\$49.95	
White Telephone Line Cord (25 ft.)	TP226	\$5.95	

Total Merchandise (\$10 Minimum Order)	\$ _____
Sales Tax	\$ _____
<p>We are required by law to collect the appropriate sales tax for each individual state, country, and locality to which the merchandise is being sent.</p>	
Shipping, Handling, and Insurance	\$ <u>5.00</u>
Total Amount Enclosed	\$ _____
<p>Use VISA or MasterCard preferably. Money order or check must be in U.S. currency only. No COD or CASH.</p>	

Prices are subject to change without notice.
 All accessories are subject to availability.



Reference

Charge your order on your VISA, MasterCard, or Discover Card by filling in below

USE YOUR CREDIT CARD

IMPORTANT: Copy complete account number from your VISA card



My card expires:

IMPORTANT: Copy complete account number from your MasterCard



Copy Number about your name on MasterCard: My card expires:

IMPORTANT: Copy complete account number from your Discover Card



My card expires:

AUTHORIZED SIGNATURE
 (Credit card order will not be processed without signature)
 Prices are subject to change without notice.

Print or type your name and address clearly.



A complete and correct order will save you days of waiting.

Name: _____

Street: _____

_____ Apt. _____

City: _____

State: _____ Zip: _____

Daytime Telephone No.: _____

Please make sure that both sides of this form have been filled out completely.

- Allow 4 weeks for delivery.
- All accessories are subject to availability.
- Prices are subject to change.

United States and Canada Orders

To place your order by phone, have your Visa, MasterCard or Discover Card ready and call the toll-free number listed below between 8 AM and 10 PM (EST) Monday through Friday or between 9 AM and 5 PM (EST) Saturday.

Use this number only to place an order for accessory items listed on this order form.

1-800-338-0376

To place your order by mail, detach and mail the completed order form with credit card information, money order or check in US currency (made payable to Thomson Consumer Electronics, Inc.) to the following address:

Video Accessories
PO Box 8419
Ronks, PA 17573

Symbols

- 16 x 9 Widescreen 48
- 4 x 3 Letterbox 48
- 4 x 3 Standard 48

A

- A•B Repeat 27
 - video CD 74
- AC IN jack 6
- Accessories 89
- ANGLE button 15, 31
- Angle, camera 31
- Angle icon 85
- ANTENNA button 15
- Arrow buttons 15, 34, 84
- Aspect ratio 48
- Audio
 - Dolby Digital 10, 51
 - DTS 51
 - PCM 51
- AUDIO button 15, 30
- Audio CD
 - loading and playing 56
 - playback features 57
- Audio channel output
 - changing, video CD 74
- Audio equipment
 - Dolby Digital 10
 - DTS 10
- Audio language 30, 45
- Audio R and L jacks 6
- AutoPlay menu 47

B

- Batteries, remote 4
- Bookmarks
 - clearing 32
 - recalling 32
 - storing 31
 - using 31
- Box, unpack 4
- Buttons
 - ANGLE 15
 - ANTENNA 15
 - Arrow 15
 - AUDIO 15
 - CH+ 15
 - CH- 15
 - CLEAR 15
 - DVD 14
 - FORWARD 16
 - FRAME- 16
 - GO BACK 16
 - GUIDE 16
 - INFO 16
 - INPUT 16
 - MENU 16
 - MUTE 16
 - Numbers (0-9) 16

- OK 16
- ON•OFF 16, 84
- OPEN•CLOSE 84
- PAUSE 17, 84
- PLAY 17, 84
- PLAY MODE 17
- REPEAT 17
- REVERSE 17
- SELECT 17
- SKIP FWD 84
- SKIP REV 84
- STOP 17
- SUBTITLE 17
- TV 14
- Vol 17
- VOLUME 84

C

- Camera angle 31
- Cancelling repeat feature 28
- CD
 - loading and playing 56
 - using Dub Assist 67
- CH+ button 15
- CH- button 15
- Changing the Audio Language 45
- Changing the Menu Language 47
- Changing your password 41
- Chapter
 - selecting 25
- Cleaning discs 79
- CLEAR button 15, 34
- Clearing a bookmark 32
- Coaxial cable 8
- Codes
 - language 54
- Connections 7, 8, 9, 10
- Controls
 - front panel 84
 - remote 14, 15, 16
- Country menu 42
- Creating a program 37

D

- Deleting a program 37
- DIGITAL AUDIO OUT jack 6, 10
- Disc
 - loading and playing 20
 - menu 20
- Disc Guide menu 38
- Disc Menu
 - accessing, video CD 72
- Disc menu 21
- Disc tray 84
- Discs
 - cleaning 79
 - digital video discs 20
 - handling 79
 - types you can't play 20, 56
- Display

- front panel 85
- Display menu 48
- Display messages 85
- Dolby Digital 10, 51
- Dolby Pro Logic 10, 11
- DTS 10, 51
- Dub Assist 67
- DVD button 14
- DVD Limits menu
 - Country 42
 - Rated Titles 43
 - Unrated Titles 44
- DVD mode 35

E

- Edit Program menu 36
- Editing a program 37
- Enter New Password 39

F

- Fast motion playback 22
- FORWARD button 16
- Frame advance 22
- FRAME- button 16
- Freeze frame (pause) 22
- Front Display menu 49
- Front panel controls 84
- Front panel display 85
- Front panel icons
 - angle 85
 - locked 85
 - play direction 85
 - repeat 85
 - unlocked 85

G

- GO BACK button 16, 34
- Go back icon 35
- Grayed out 24, 35
- GUIDE button 16

H

- Handling
 - cautions 79
 - discs 79
 - DVD Player 79
- Headphones jack 84
- Help
 - how to get 80
- Highlight 12, 34
- How to find your TV's video input channel 13

Index

I

- Icons 24
- Index
 - selecting, video CD 72
- INFO button 16
- Info Display
 - picture of 24
 - using 24
- INPUT button 13, 16
- Installing batteries 4
- Invalid icon 24

J

- Jacks
 - AC IN 6
 - AUDIO OUT R L 6
 - DIGITAL AUDIO OUT 6
 - R and L 6
 - RF ADAPTER 6
 - S-VIDEO 6
 - VIDEO OUT 6

L

- Language
 - changing the menu 47
 - subtitles 46
- Language code list 54
- Language Options 12
- Language Prefs menu 44
- List
 - language codes 54
- Loading a disc
 - audio CD 56
 - digital video disc 20
 - video CD 70
- Lock Menu 39
- Locked icon 39, 85
- Locking your DVD Player 39

M

- Main menu items
 - Disc Guide 38
 - Lock 39
 - Play 36
 - Setup 44
- Maintenance 79
- MENU button 16
- Menu icon 25
- Menu item, grayed out 35
- Menu language 12
- Menus
 - path 34
 - static 34
 - types 34
- Messages
 - front panel 85
- Modes, remote control 18, 35
- Motion Pictures Association of America 43
- MUTE button 16

N

- Navigation 12, 34
- Number buttons 16

O

- OK button 16, 34
- ON•OFF button 16, 84
- On-screen info display 24, 57
- OPEN•CLOSE button 84
- Order form, accessories 89

P

- Password 39, 41
- Path menu item 34
- PAUSE button 17, 84
- PCM 51
- Picture scan 22
- PLAY button 17, 84
- Play direction icon 85
- Play Menu 36
 - program play 36
 - random play 36
 - standard play 36
- PLAY MODE button 17
- Play Modes
 - program 26
 - selecting 26
- Playback control
 - video CD 71
- Playback features
 - audio CD 57
 - audio language 30
 - bookmarks 31
 - camera angle 31
 - fast motion 22
 - repeat 27
 - selecting a chapter 25
 - selecting play modes 26
 - slow motion 23
 - subtitle language 29
 - using disc menu 25
- Playing
 - CDs 56
 - digital video discs 20
- Program
 - creating 37
 - deleting 37, 61
 - editing 37
- Programming the remote 86

R

- R and L jacks 6
- Rated Titles 43
- Rating Limits 42
- Recalling bookmarks 32
- Regional coding 19
- Remote control
 - using to move through menus 34
- Remote control
 - component buttons 14
 - helpful hints about 18
 - other buttons 15
 - pointing 18
 - Programming 86
- Remote, installing batteries 4
- Repeat
 - A•B 27
 - cancelling 28
- REPEAT button 17
- Repeat icon 85
- Repeat Play
 - video CD 73
- REVERSE button 17
- RF ADAPTER jack 6
- RF output adapter 8

S

- S-VIDEO jack 6
- SELECT button 17
- Selecting a chapter 25
- Selecting a Title 24
- Selecting play modes 26
- Setup menu 33, 44
- SKIP FWD button 84
- SKIP REV button 84
- Skipping tracks
 - video CD 72
- Slow motion playback 23
- Solutions 76, 77, 78
- Sound Logic 50, 51
- Sound menu 50
- Static menu item 34
- STOP button 17, 84
- Storing bookmarks 31
- SUBTITLE button 17
- Subtitle language 29, 46
- System Test menu 52

T

Title 24

Track

 selecting, video CD 72

 skipping, video CD 72

Troubleshooting 76, 77, 78

TV button 14

TV codes 88

TV Image menu 48

TV's Video Input Channel 13

Types of Discs the Player Can Play 4

U

Unlocked icon 39, 85

Unlocking the player 40

Unpack the box 4

Unrated titles 44

Using bookmarks 31

V

VCR

 connecting it 9

 watching it 9

Video Input Channel 7, 13

VIDEO OUT jack 6

VOL + and - buttons 84

VOL up and down buttons 17

 **THOMSON CONSUMER ELECTRONICS**

10330 North Meridian Street
Indianapolis, IN 46290

©1999 Thomson Consumer Electronics, Inc.
Trademark(s)® Registered
Marca(s) Registrada(s)
Printed in USA
TOCOM 1541658A



100%
RECYCLED PAPER
MINIMUM 40% POST CONSUMER



Free Manuals Download Website

<http://myh66.com>

<http://usermanuals.us>

<http://www.somanuals.com>

<http://www.4manuals.cc>

<http://www.manual-lib.com>

<http://www.404manual.com>

<http://www.luxmanual.com>

<http://aubethermostatmanual.com>

Golf course search by state

<http://golfingnear.com>

Email search by domain

<http://emailbydomain.com>

Auto manuals search

<http://auto.somanuals.com>

TV manuals search

<http://tv.somanuals.com>