

# RCA

## Digital Video Recorder User's Guide

Changing Entertainment. Again.

TOCOM 16282980



# DVR10

# Important Information



## CAUTION

RISK OF ELECTRIC SHOCK  
DO NOT OPEN



CAUTION: TO REDUCE THE RISK OF ELECTRIC SHOCK, DO NOT REMOVE COVER (OR BACK). NO USER SERVICEABLE PARTS INSIDE. REFER SERVICING TO QUALIFIED SERVICING PERSONNEL.



The lightning flash with arrowhead symbol, within an equilateral triangle, is intended to alert the user to the presence of uninsulated "dangerous voltage" within the product's enclosure that may be of sufficient magnitude to constitute a risk of electric shock to persons.



The exclamation point within an equilateral triangle is intended to alert the user to the presence of important operating and maintenance (servicing) instructions in the literature accompanying the appliance.

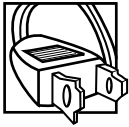

Caution: To prevent electric shock, match wide blade of plug to wide slot, fully insert.

## Cautions on Installation

Noise or disturbance of the picture may be generated if this unit or any other electronic equipment using microprocessors is used near a tuner or TV.

If this happens, take the following steps:

- Install this unit as far as possible from the tuner or TV.
- Set the antenna wires from the tuner or TV away from this unit's power cord and input/output connection cords.
- Noise or disturbance tends to occur particularly when using indoor antennas or 300 ohms feeder wire. It is recommended that you use outdoor antennas and 75 ohm coaxial cables.

## Product Registration

Please fill out the product registration card (packed separately) and return it immediately. Returning the card allows us to contact you if needed.

## Product Information

Keep your sales receipt to obtain warranty parts and service and for proof of purchase. Attach it here and record the serial and model numbers in case you need them. These numbers are located on the product.

Model No. \_\_\_\_\_

Serial No. \_\_\_\_\_

Purchase Date: \_\_\_\_\_

Dealer/Address/Phone: \_\_\_\_\_

## Safety Instructions

1. Read Instructions – All the safety and operating instructions should be read before operating this device.
2. Heed Warnings – All warnings on the device and in the User Manual should be adhered to.
3. Follow Instructions – All operating and user instructions should be followed.
4. Water and Moisture – The device should not be used near water – for example, near a bath-tub, washbowl, kitchen sink, laundry tub, in a wet basement, or near a swimming pool, and the like.
5. Ventilation – The device should be situated so that its location or position does not interfere with its proper ventilation. For example, the appliance should not be situated on a bed, sofa, rug, or similar surface that may block the ventilation openings; or, placed on a built-in installation, such as a bookcase or cabinet that may impede the flow of air through the ventilation openings.
6. Heat – The device should be situated away from heat sources such as radiators, heat registers, stoves, or other appliances (including amplifiers) that produce heat.
7. Power Sources – The device should be connected to a power supply only of the type described in the operating instructions or as marked on the device.
8. Power-cord Protection – Power-supply cords should be routed so that they are not likely to be walked on or pinched by items placed upon or against them, paying particular attention to cords at plugs, convenience receptacles, and the point where they exit from the appliance.
9. Non-use Periods – The power cord of the device should be unplugged from the outlet when left unused for long periods of time.
10. Object and Liquid Entry – Care should be taken so that objects do not fall and liquids are not spilled into the enclosure through the openings.
11. Damage Requiring Service – The device should be serviced by qualified service personnel when:
  - a. The power-supply cord or the plug has been damaged; or
  - b. Objects have fallen, or liquid has been spilled into the enclosure; or
  - c. The device does not appear to operate normally or exhibits a marked change in performance; or
  - d. The device has been dropped, or the enclosure damaged.
12. Servicing – The user should never attempt to service the device beyond that described in the operating instructions. All other servicing should be referred to qualified service personnel.

# Table of Contents

---

## Chapter 1: Overview and Setup

Introduction .....	3
Requirements .....	3
List of Contents .....	3
Device Description .....	3
DVR10 Front.....	3
DVR10 Back.....	4
Things to Consider Before You Connect.....	4
Ensure Proper Ventilation of the DVR10 .....	4
IEEE-1394 Cables: 4-Pin and 6-Pin.....	5
Protect Against Power Surges .....	5
Connecting the DVR10.....	5
Connecting Other IEEE 1394 Devices .....	5
Component Connection Methods.....	6
Incorrect Hub Connection.....	7
When Connecting Other IEEE 1394 Devices .....	7
Adding IEEE 1394 Devices Automatically.....	7
DVR10 Device Configuration.....	7
1394 Recording Setup .....	8
1394 Recording .....	9

## Chapter 2: Using the DVR10

Using the DVR10 .....	10
Controlling Live Digital Television .....	
Pausing Live TV and Recorded Shows.....	10
Transport Functions.....	10
RECORD.....	10
STOP.....	10
Fast FORWARD and Fast REVERSE Playback .....	11
PAUSE.....	11
Instance Replay and Jump Ahead .....	11
Next and Previous Track.....	12
Program Information.....	12

Copy-Protected Materials .....	13
--------------------------------	----

## Chapter 3: Other Information

Care and Cleaning .....	14
Troubleshooting .....	14
Specifications.....	15
Limited Warranty .....	16
FCC Declaration of Conformity.....	17

## Introduction

The DVR10 is a Digital Video Recorder designed specifically for High Definition Television (HDTV). The DVR10 connects to a Digital Television (DTV) via IEEE 1394 to offer control over the digital video playback. Think of it as a "tape-less" VCR for digital television. You can pause, fast forward, reverse, or use instant replay, so you'll never miss a moment. But unlike a traditional VCR where you wait for a program to finish recording before you start watching it, the DVR10 allows you to "Pause Live TV." This means you can pause, rewind, and play back a program as it is being recorded. Record all of your favorite programs while maintaining the same high quality digital picture that it was broadcast in.

## Requirements

Digital Television with at least one IEEE 1394 jack and supports AV/C (Audio/Video commands)

## List of Contents

- DVR10 Unit
- A/C Power Cord
- IEEE 1394 Cable

## Device Description

### DVR10 Front

The front of the DVR10 has a clean professional look to coincide with your other high-end audio/video equipment. It has backlit text display to indicate the status of the unit.

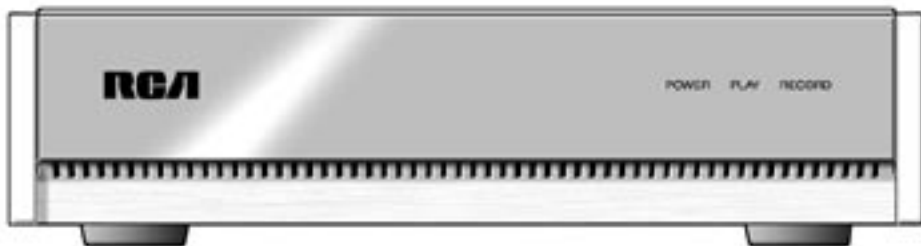

- POWER – illuminated when the unit is plugged in to an AC power source.
- PLAY – illuminated when a previously recorded program is being played back.
- RECORD – illuminated while a new program is being recorded for future playback.

*Note: The DVR10 records and plays back different programs at the same time. Both the PLAY and RECORD may be illuminated.*

# Overview & Setup

## DVR10 Back

The back of the DVR10 has two 6-pin DTVLink® or IEEE 1394 ports and an A/C power cord connector. Devices using IEEE 1394 interface can be connected to either port. Devices certified as DTVLink use the same IEEE 1394 interface but also include advanced copy protection schemes to send and receive encrypted or copy protected content.



## Things to Consider Before You Connect

### Ensure Proper Ventilation of the DVR10:

- Leave at least 4 inches (10 cm) of space between the top and back of the DVR10 and a wall, shelf, or other component.
- Leave at least 1" (2.5 cm) of space on the front and sides.
- Do not block ventilation holes on any of the components.
- Arrange the components so that air can circulate freely.
- Do not stack components on top of the DVR10.
- When you place components in a stand, make sure you allow adequate ventilation.
- If you connect an audio receiver or amplifier, place it on the top shelf so the heated air from it won't flow around other components.

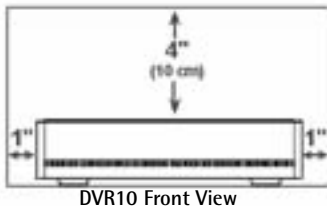

DVR10 Front View

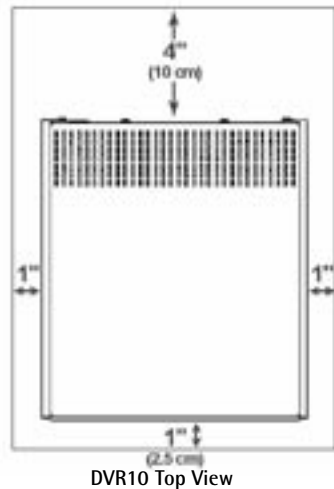

DVR10 Top View

DTVLink® Certification Logo is a U.S. registered mark of CEA.

## IEEE-1394 Cables: 4-Pin and 6-Pin

There are two different types of connectors used on IEEE 1394 devices: a 4-pin style, and a 6-pin style.

The 4-pin connector is capable of sending digital audio signals, digital video signals and digital control signals back and forth between devices. The 6-pin connector is capable of sending the same data and signal information as the 4-pin but has two additional pins for sending low voltage electrical power. The purpose of this electrical power is to provide the needed operating power to a device that is not connected directly to the household AC power such as some camcorders. The DVR10 uses a 6-pin cable but does not supply power to other devices.

A 6-pin connector cannot be connected directly to a 4-pin jack, and vice versa. To connect a 6-pin device to a 4-pin device, you need to obtain a 6-pin to 4-pin adaptor cable. These cables are available from electronic and computer stores.



## Protect Against Power Surges

- Connect all components before you plug any power cords into the wall outlet.
- Turn off the TV and/or component before you connect or disconnect any cables.
- Make sure all antennas and cables are properly grounded.

## Connecting the DVR10

To connect the DVR10 to a 1394 or DTVLink enabled TV, follow these steps:

1. Connect the female end of the AC power cord to the DVR10 and male end into an AC outlet or surge protector.
2. Connect the 1394 cable to either 1394 port on the HDTV and to either 1394 port on the DVR10.

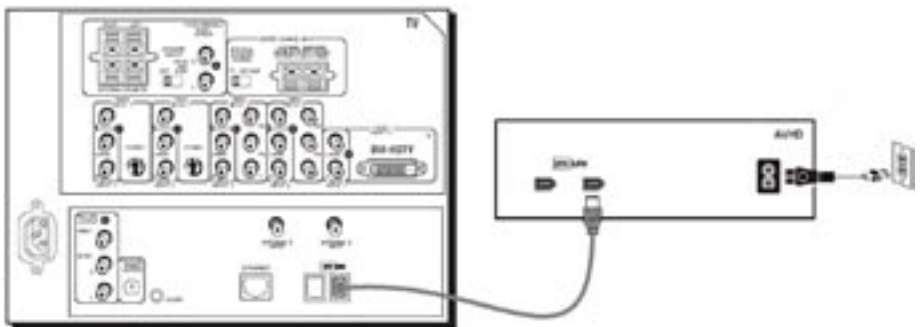

## Connecting Other IEEE 1394 Devices

One of the great advantages to 1394 components is the ability to connect one device to the next in a single chain. This is known as "daisy-chaining." Previous audio and video components often required connections of each component to a single source such as an audio/video receiver or TV. With IEEE 1394, simply connect one device to the next in a continuous chain using 1394 cables.

# Overview & Setup

The 1394 interface reduces the number of cables needed to connect each device and simplifies the connection process. There is no need to ensure that you are connecting the correct audio or video cable to the correct jack. IEEE 1394 uses a single cable to transfer audio, video, and interface data between all devices connected within the chain.

The DVR10 has two 1394 ports. This allows you to use one port for connection to your digital television and still have another port for connection of additional 1394 components. Each compatible device connected on the IEEE 1394 chain is shown on the DTV. Information can be sent between 1394 connected components. DTVLink and other compatible components can be controlled from your DTV.

## Component Connection Methods

There are two ways to connect IEEE 1394 and DTVLink devices: component-to-component and hub connection. The component-to-component method has each component connected in a chain-like fashion, with the DTV as the first component. The hub method is basically the same but uses both 1394 jacks on the DTV with two chains of components connected to it.

*Note: Use a single 1394 cable to connect one device to any available 1394 port on the next device. If devices such as a digital camera only have one 1394 port, these devices should be placed at the end of the 1394 chain.*

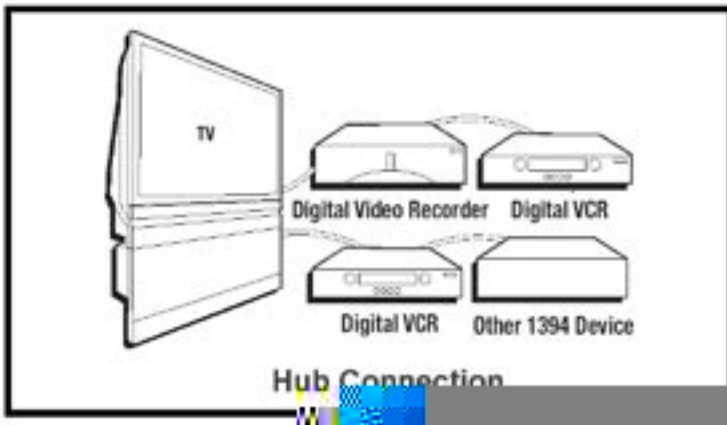
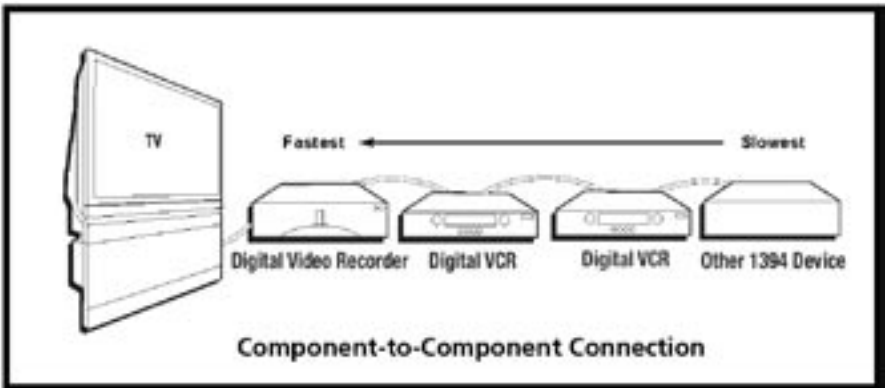





# Overview & Setup

## 1394 Recording Setup

To record digital content to the DVR10, you may need to set up 1394 recording from the TV's *Connections* menu. Use the MENU button on the remote control to access the *Connections* menu and configure the DVR10 for 1394 Recording.

1. Press MENU on the TV's Remote control.
2. Use the Down Arrow to highlight *Connections* and press OK or press the number 6 on the remote.
3. Highlight and select *1394 Setup* or press number 7 on the remote.
4. Highlight and select *1394 Recording* or press 2 on the remote.

*Note: The "DTVLink Connection" menu is for recognizing and configuring devices, which require an analog connection, and does not pertain to the DVR10.*

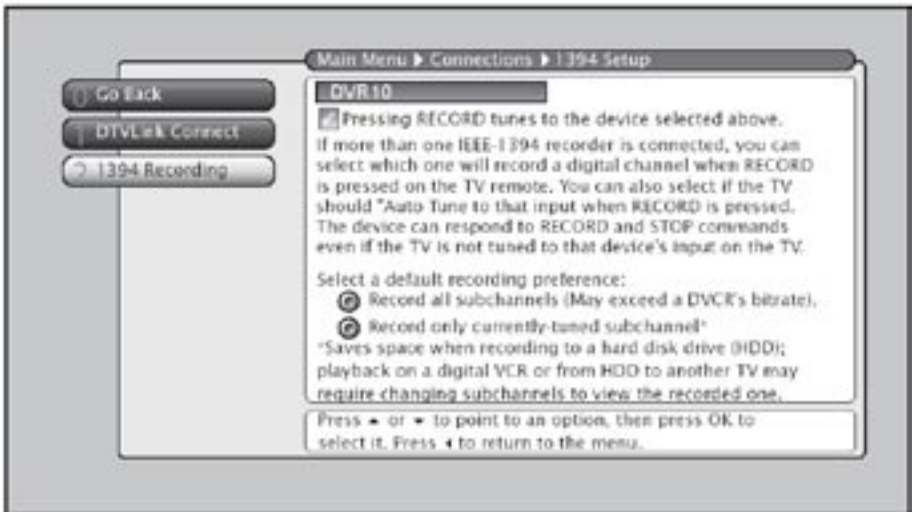

The 1394 Recording screen allows you to configure 1394 components that are capable of recording. If the DVR10 is connected and powered on, it appears in the list at the top of the screen. If you have more than one 1394 recording device, you may need to highlight the Recording Device window at the top of the screen and select the DVR10.

- Use the Right Arrow to highlight the Recording Device list. If the DVR10 is not displayed, press OK to toggle the device in the list until you see the DVR10.
- With the DVR10 selected, use the Down Arrow to highlight the *Auto Tune* check box. Press OK to check the box.

With the TV remote in TV mode, pressing the RECORD and STOP buttons start and stop recording to the DVR10. With the box checked next to "Pressing RECORD tunes to the device selected above," the TV automatically tunes to the DVR10 input which shows the program stream being recorded to the DVR10. This allows you to use time shifting functions such as Pause, Instant

Replay, and Jump Ahead. If the box is unchecked, the TV remains tuned to the incoming cable or antenna feed and time shifting functions are not available.

*Note: If you don't check the auto tuning check box, pressing RECORD only starts the recording—it doesn't switch the TV to the DVR10's 1394 input—you'll need to use the INPUT button to channel through the inputs.*

- Use the Down Arrow and select "Record all subchannels." To use less DVR space, select "Rec. only currently-tuned subchannel."
- Ensure the DVR10 is still displayed in the device list and press the MENU button on the remote to exit the Setup screens.

The last device displayed on the 1394 Recording screen when the menu is closed becomes the default recording device. This device is used when the RECORD button is pressed on the remote or a timed recording is scheduled. Ensure that the DVR10 is shown in the Recording Device list when the screen is closed.

## 1394 Recording

The DVR10 uses the 2-way IEEE 1394 interface for connection to compatible digital televisions. This allows you to control the DVR10's record and playback functions using the TV's remote.

### You should know:

- Only digital content (ATSC signals) can be recorded. Analog TV programs (NTSC signals) cannot be recorded through the TV's 1394 jack.
- The DVR10 has built-in hardware for support of copy protection standards and is able to record authorized copy protected content. If the content provider does not authorize content recording of any type, the program cannot be recorded to the DVR10.
- The TV must be tuned to the DVR10's 1394 input channel and the remote in the TV mode to enable transport functions, such as RECORD, STOP, FAST FORWARD, REVERSE, PAUSE, and PLAY.
- If recording and you change to an analog channel, the recording is stopped. If recording and you change to a digital channel, the new digital channel is recorded. If recording and you change to a video input, the channel you were recording continues to record.
- A dialog box appears when you press the RECORD button to let you know the 1394 component is recording the channel that you selected.

You can select a default recording preference, record all subchannels on a major channel, or record only a specific subchannel. Recording just the subchannel saves space on the DVR10. However, if you're recording to a DVR10 and choose to record only to a specific subchannel, you may see a blank screen when playing back at first. You'll need to use the CH+ or CH- button to go through the subchannels before you find the subchannel you recorded. This happens because the data of all the subchannels is recorded, but not the content—only the content (or complete signal) for the specified subchannel is recorded. If multiple languages are available for a program, only the "audio language" you were listening to is recorded.

To schedule a timed 1394 recording, use the Record/Wake Timer screen. Ensure the DVR10 is selected in the 1394 Recording menu and see your DTV Owner's Manual for more information on scheduled recordings.

# Chapter 2: Using the DVR10

## Using the DVR10

### Controlling Live Digital Television

The DVR10 gives you the power to watch television the way you have always wanted. You can watch what you want to watch, when you want to watch it. You can also control what you are watching like never before.

Whether it's the big game, that classic movie, or your favorite soap, press the RECORD button on your remote and you're in control. The digital program begins recording to your DVR10 and enables you to Stop, Pause, or even Rewind the digital program that you are watching. Press the Left Arrow for an Instant Replay of the last 7 seconds or the Right Arrow to Jump Ahead 30 seconds.

You can even Pause the program to answer the phone without missing one minute. Just press PLAY to begin right where you left off. You can use the Jump Ahead feature or Fast Forward to catch up to the "live broadcast."

### Pausing Live TV and Recorded Shows

The Pause feature lets you attend to interruptions without missing a moment of your favorite digital-TV show. You can pause whatever you're watching, whether it's a live television broadcast you're currently recording or a previously recorded show. When you Pause a live broadcast, the DVR10 continues to record on the hard drive so you won't miss a single moment.

### Transport Functions

Transport Functions are commands that most people are familiar with from using a standard VCR. They include: RECORD, STOP, FORWARD, REVERSE, PAUSE, and PLAY. When the TV is recording a digital program and tuned to the DVR10 input, the DVR10 is set as the default recording device. Pressing the transport buttons on the remote control causes the DVR10 to act like a Digital VCR with a few bonus features. When the TV is tuned to a 1394 device, the commands are sent to that 1394 device.

*Note: If you select the "Record all subchannels" in the 1394 Recording screen, the transport functions work only on the first subchannel when all subchannels (whole stream) are recorded. To make sure the transport functions always work, set the 1394 Recording default to "Record only currently-tuned subchannel."*

#### RECORD

If the TV is set up to auto tune as previously described, pressing RECORD automatically tunes the TV to the DVR10's 1394 input and begins recording. If the TV is tuned to an *Analog* channel, pressing RECORD tunes to the 1394 input but NO recording takes place.

*Note: The Auto Tuning box for the DVR10 must be checked in the 1394 Recording screen to enable time-shifting functions.*

#### STOP

Pressing STOP during a recording ends the recording process. If a STOP command is issued when recording and playing back simultaneously, the TV stops the recording, but keeps the playback going. Pressing STOP again will stop the playback.

## Fast FORWARD and Fast REVERSE Playback

The DVR10 gives you the power to Fast Forward or Fast Reverse through both live (currently recording) and previously recorded programs. You cannot fast reverse a program to a point before you started recording it, nor can you fast forward a program to a point beyond the live broadcast.

To use Fast Forward while watching a show:

1. Press FORWARD for 3x Fast Forward.
2. Press FORWARD again for 15x Fast Forward.
3. Press FORWARD again for 60x Fast Forward.
4. Press PLAY or STOP, to stop Fast Forwarding.

*Note: Pressing REVERSE from 60x Fast Forward takes you to 15x Fast Forward and so forth.*

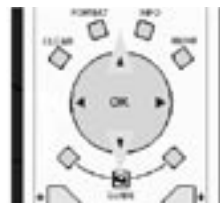

To use Fast Reverse while watching a show:

1. Press REVERSE for 3x reverse playback.
2. Press REVERSE again for 15x Reverse playback.
3. Press REVERSE again for 60x Reverse playback.
4. Press PLAY or STOP to stop Reverse playback.

*Note: Pressing FORWARD from 60x Reverse takes you to 15x Reverse and so forth.*

When using FORWARD to advance through a recording or track, the DVR10 moves through that recording until it reaches the end of the recording and stops. The same applies to REVERSE.

## PAUSE

Press PAUSE to pause the screen during the recording of live programs and playback of previously recorded programs. If PAUSE is pressed during a recording, the TV pauses the playback but keeps the recording going.

To Pause a Live Broadcast that is being recorded or a previously recorded program:

1. Press PAUSE on the TV's remote control.
2. Press PLAY to continue playing the program from the point you paused.

Other Pause options include:

- Press INFO to view program information.
- Press CLEAR to remove the on-screen display.

*Note: If a program has been paused for more than 3 minutes, a screen saver appears to prevent damage to the TVs that have picture tubes or projection screens.*

## Instant Replay and Jump Ahead

You only look away for a few seconds but you know you missed something big. Maybe it was just too great of a moment to only see once. The Instant Replay feature lets you jump back 7 seconds during a live or recorded show. It's the perfect way to ensure you don't miss a single word of dialog in your favorite movie, or if you want to watch a great play over again.

# Using the DVR10

You can use the Jump Ahead feature to jump quickly 30 seconds ahead during live or recorded shows. Jump Ahead is perfect for jumping past programs and undesired scenes without having to watch them as you would using Fast Forward. Jump Ahead can only be used during live broadcasts if the show is being recorded and you are watching the show delayed by more than 30 seconds.

To use Instant Replay while watching a recorded show:

- Press Left Arrow on the TV's remote control to replay the previous 7 seconds in the recording.

To use Jump Ahead while watching a show:

- Press Right Arrow on the TV's remote control to just ahead 30 seconds into a recording.
- Press repeatedly to leap ahead in 30-second intervals.

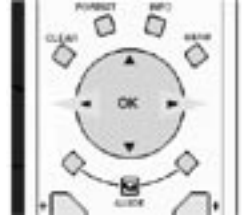

## Next and Previous Track

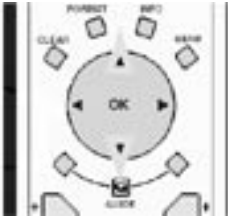

Next and Previous Track features allow you to jump quickly to the next or previously recorded program on the DVR10. Press the Up Arrow to skip to the next track. Press the Down Arrow to skip to the previous track. The track being played and the total number of tracks recorded is shown in the channel banner when the track is changed. (See below.)

*Note: Use CH+ to tune to different subchannels (if available) on each track.*

## Program Information

At any time while recording a digital program or playing back a recorded program, you can press the INFO button on your remote control to get more information from the channel banner. The program name, channel, track number, 1394 recording device, and elapsed time for 1394 recordings appear in the channel banner.



If an icon in the channel banner is grayed out (dim), the feature is not available. The following list describes the items on the Channel Banner screen applicable to the DVR10. Other displays that are not described here are self-explanatory or further explained in the television manual.

Subchannel - Sub-channel and the station call letters, if available. For the different sub-channels, press the CH+ or CH-.

*Note: Digital channels are often noted by the use of a sub-channel. (Channel 2 may denote an analog channel while channel 2-1 is often a digital version of the channel 2 broadcast.)*

**Track** – Displays the total number of recorded programs or tracks on the DVR10 and which track is currently being displayed. Press the Up/Down Arrow buttons to scroll through the track numbers (recordings) recorded on the DVR10.

**Antenna/Auto Tuning/DTVLink** – Type of signal (Antenna A/B, Air/Cable) you're viewing and what input jack a component is connected to. DVR10 is listed when playing from the device.

**16:9 1080i HD** – Aspect ratio (4:3 or 16:9); original resolution of the broadcast (e.g., 480i, 1080i, etc.), not the resolution of the TV; HD denotes High Definition and SD denotes Standard Definition digital broadcasts.

**00h:00m:00s of 00h:00m:00s** – Denotes the present location within the total recorded time of a program or track.

## **Copy-Protected Material**

The DVR10 uses special hardware and advanced content protection schemes to securely record and play allowable copy protected material over the 1394 interface. Some content providers do not allow their content to be recorded. When attempting to record unauthorized copy-protected material, the Record functions of the DVR10 may be prevented or stopped. If REC icon in the Channel Banner is dim, that means the program cannot be recorded.

# Chapter 3: Other Information

## Care and Cleaning

CAUTION: Unplug the DVR10 before cleaning.

You can clean the DVR10 as required, using a soft lint-free cloth. Be sure to occasionally dust the ventilation slots in the cabinet to help assure adequate ventilation.

Never use strong cleaning agents, such as ammonia-based cleaners, or abrasive powder. These types of cleaners will damage the finish of the DVR10.

## Troubleshooting

### **DVR won't work**

- Try unplugging the AC power cord and plugging it back in at both ends.
- Make sure the DVR is connected and cables are seated properly.
- If the unit doesn't appear on the TV or set-top box screen, unplug the 1394 cable (DTVLink) and reconnect.
- Make sure TV is tuned to the DVR10 video input.

### **Program(s) not recorded**

- Make sure you have selected a digital channel; the DVR10 does not record analog channels.
- If the channel is changed when the DVR10 is recording, the DTV stops sending the program and ends the recording process.
- Check the timed recording in the Record/Wake Timer screen on the TV to make sure the correct channel and antenna was selected.
- When playing back a recorded sub-channel, you might have to channel through the sub-channels to get to the sub-channel you recorded. Press CH+ or CH-.

### **DVR10 Too Hot**

- If the DVR10 is currently "playing" content and senses an over temperature condition, it shall display the following: "Unit has exceeded Maximum safe operating temperature. Please move to a cooler environment and restart unit." The DVR10 has built-in sensors that monitor the unit's temperature. Extremely high temperatures adversely affect the unit's longevity and may affect its ability to effectively record and play digital content.
- All front panel LEDs flash on and off to indicate an over temp condition. Disconnect the 1394 and power cables and move the unit to cooler location. When the unit has been allowed to cool, plug in the power cord to power up the unit. Once the DVR10 is powered up, connect the 1394 cable to the television.

### **1394 Device No Longer Connected**

If a non-correctable error has occurred or the power or 1394 cable has been disconnected, the following message appears: "A 1394 device is no longer connected to the network. If this was unintentional, please check your connections."

- Press OK to clear screen.
- Check all cables to make sure they're connected and firmly seated.
- If all cables are firmly attached, disconnect the 1394 cable, wait 10 seconds, and reconnect. This will reinitialize the DVR10 on the 1394 network.



## Specifications\*

### Interface Specifications

- IEEE 1394 compliant
- AV/C compliant
- SBP-2 compliant
- Supports serial bus data transfer rates of 100, 200, and 400 Mb/sec
- Two external 6-pin FireWire® connectors
- Hot-plug capability

### Drive Specifications

Capacity	80 GB (Formatted Capacity 80,026 MB)
Average Read Seek	8.9 ms (typical)
Track-to-Track Seek	2.0 ms (typical)
Average Latency	4.2 ms
Rotational Speed	5400 RPM
Buffer	2 MB
Drive Ready Time	8.0 sec average

### Environmental Conditions

Operating Temperature	0° to 35°C
Non-Operating Temperature	-20° to 65°C
Acoustics (typical) Idle Mode:	33 dBA average

### Power Requirements

AC Input Voltage	100-240 VAC
AC Input Frequency	50-60 Hz
AC Input Current	0.3A max (RMS)

### Physical Dimensions

Height	2.0 in. (5 cm)
Length	10.28 in. (25.7 cm)
Width	8.45 in. (21.13 cm)

\*Specifications are subject to change without notice.

FireWire® is a trademark of Apple Computer, Inc., registered in the U.S. and other countries.

# Other Information

---

## Limited Warranty

### **What your warranty covers:**

- Defects in materials or workmanship.

### **For how long after your purchase:**

- 90 days from date of purchase for labor.
- One year from date of purchase for parts.

The warranty period for rental units begins with the first rental or 45 days from date of shipment to the rental firm, whichever comes first.

### **What we will do:**

- Exchange the Digital Video Recorder unit with a new or, at our option, refurbished unit.

### **How you get service:**

- Call 1-877-722-4388 and have your unit's date of purchase and model/serial number ready. The model/serial number information is on the back of your unit.
- A representative will troubleshoot your problem over the phone.
- If the representative determines that you should receive a replacement unit, you will be provided with a Service Request (SR number and the location of a nearby exchange point if one exists. No returns will be accepted without the SR number.
- Proof of purchase in the form of a bill of sale or receipted invoice, which is evidence that the product is within the warranty period, must be presented to obtain warranty service. For rental firms, proof of first rental is also required.

### **What your warranty does not cover:**

- Acts of nature, such as but not limited to lightning damage.
- Adjustment of customer controls.
- Damage from misuse or neglect.
- A unit that has been modified or incorporated into other products or is used for institutional or other commercial purposes.
- Batteries.
- Software/stored program content.
- Units purchased or serviced outside the U.S.A.
- Shipping damage if the unit was not packed and shipped in the manner prescribed by Thomson.

### **Product Registration:**

- Please complete the online Product Registration on [www.rca.com](http://www.rca.com) or complete and mail the Product Registration Card packed with your unit. It will make it easier to contact you should it ever be necessary. The return of the card is not required for warranty coverage.

### **Limitation of Warranty:**

- THE WARRANTY STATED ABOVE IS THE ONLY WARRANTY APPLICABLE TO THIS PRODUCT. ALL OTHER WARRANTIES, EXPRESS OR IMPLIED (INCLUDING ALL IMPLIED WARRANTIES OF MERCHANTABILITY OR FITNESS FOR A PARTICULAR PURPOSE) ARE HEREBY DISCLAIMED. NO VERBAL OR WRITTEN INFORMATION GIVEN BY THOMSON INC., ITS AGENTS OR EMPLOYEES SHALL CREATE A WARRANTY OR IN ANY WAY INCREASE THE SCOPE OF THIS WARRANTY.
- REPAIR OR REPLACEMENT AS PROVIDED UNDER THIS WARRANTY IS THE EXCLUSIVE REMEDY OF THE CONSUMER. THOMSON INC. SHALL NOT BE LIABLE FOR INCIDENTAL OR

CONSEQUENTIAL DAMAGES RESULTING FROM THE USE OF THIS PRODUCT OR ARISING OUT OF ANY BREACH OF ANY EXPRESS OR IMPLIED WARRANTY ON THIS PRODUCT. THIS DISCLAIMER OF WARRANTIES AND LIMITED WARRANTY ARE GOVERNED BY THE LAWS OF THE STATE OF INDIANA. EXCEPT TO THE EXTENT PROHIBITED BY APPLICABLE LAW, ANY IMPLIED WARRANTY OF MERCHANTABILITY OR FITNESS FOR A PARTICULAR PURPOSE ON THIS PRODUCT IS LIMITED TO THE APPLICABLE WARRANTY PERIOD SET FORTH ABOVE.

## How state law relates to warranty:

- Some states do not allow the exclusion nor limitation of incidental or consequential damages, or limitations on how long an implied warranty lasts, so the above limitations or exclusions may not apply to you.
- This warranty gives you specific legal rights, and you also may have other rights that vary from state to state.

## If you purchased your product outside the United States:

- This warranty does not apply. See your dealer for warranty information.

## FCC Declaration of Conformity

This device complies with part 15 of the FCC Rules. Operation is subject to the following two conditions: (1) This device may not cause harmful interference, and (2) this device must accept any interference received, including interference that may cause undesired operation.

Trade Name:	RCA
Model(s) :	DVR-10
Equipment Classification:	Digital Video Recorder
Responsible Party:	Thomson, Inc. 10330 N. Meridian St. Indianapolis, IN 46290 Telephone (580) 634-0151

This equipment has been tested and found to comply with the limits for a Class B digital device, pursuant to Part 15 of the FCC Rules. These limits are designed to provide reasonable protection against harmful interference in a residential installation. This equipment generates, uses, and can radiate radio frequency energy and, if not installed and used in accordance with the instructions, may cause harmful interference to radio communications. However, there is no guarantee that interference will not occur in a particular installation. If this equipment does cause harmful interference to radio or television reception, which can be determined by turning the equipment off and on, the user is encouraged to try to correct the interference by one or more of the following measures:

- Reorient or relocate the receiving antenna.
- Increase the separation between the equipment and receiver.
- Connect the equipment into an outlet on a circuit different from that to which the receiver is connected.
- Consult the dealer or an experienced radio/TV technician for help.

This Class B digital apparatus complies with Canadian ICES-003.

*Note: The User is cautioned that changes or modifications not expressly approved by the party responsible for compliance could void the user's authority to operate the equipment.*

Visit the RCA web site at [www.rca.com](http://www.rca.com)

---

Please do not send any products to the Indianapolis address listed in this manual or on the carton. This will only add delays in service for your product.

Thomson Inc.  
10330 North Meridian Street  
Indianapolis, IN 46290

©2003 Thomson Inc.  
Trademark(s)® Registered  
Marca(s) Registrada(s)  
Printed in USA

**TOCOM 16282980**

  
**THOMSON**

**THOMSON** 

## Free Manuals Download Website

<http://myh66.com>

<http://usermanuals.us>

<http://www.somanuals.com>

<http://www.4manuals.cc>

<http://www.manual-lib.com>

<http://www.404manual.com>

<http://www.luxmanual.com>

<http://aubethermostatmanual.com>

Golf course search by state

<http://golfingnear.com>

Email search by domain

<http://emailbydomain.com>

Auto manuals search

<http://auto.somanuals.com>

TV manuals search

<http://tv.somanuals.com>