

# Radium™

216MHz

## user guide

920SR speaker

921T body-worn transmitter

922T handheld transmitter

923C charging stand

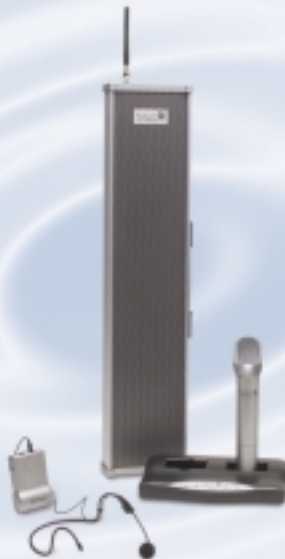

 **Phonic Ear®**

# contents

introduction . . . . .	1	922T handheld transmitter operation . . . . .	41-46
understanding sound field . . . . .	2	aux in – connecting to TV, CD, VCR, etc. . . . .	47
setup tips . . . . .	3-5	aux out – connecting to personal devices . . . . .	48-49
daily operating tips . . . . .	6-8	additional system accessories . . . . .	50-51
parts and accessories included with system . . . . .	9-10	troubleshooting . . . . .	52-53
920SR column speaker features . . .	11-14	Radium channel numbers and corresponding frequencies . . . . .	54
921T body-worn transmitter features .	15-16	product specifications . . . . .	55-57
922T handheld transmitter features . . .	17	warranty . . . . .	58-60
923C charging stand features . . . . .	18	regulatory approvals and clearances .	61-64
system setup and operation . . . . .	19-28		
920SR speaker placement and mounting . . . . .	29-34		
921T body-worn transmitter operation . . . . .	35-40		

# introduction

Congratulations on the purchase of your new Radium sound field system! With proper care and use it will become one of your most valuable classroom educational tools. Students will be able to consistently and easily understand the teacher, regardless of their location in the classroom, or competing internal or external background noise. Teachers can now speak all day in their normal voice without having to raise their voice to get their students' attention.

Numerous studies show that classrooms using sound field enjoy better student comprehension, increased student participation, better grades and fewer behavioral referrals.

Read this manual carefully to become familiar with your system and to get the most out of its many features and options.

# understanding sound field and its benefits

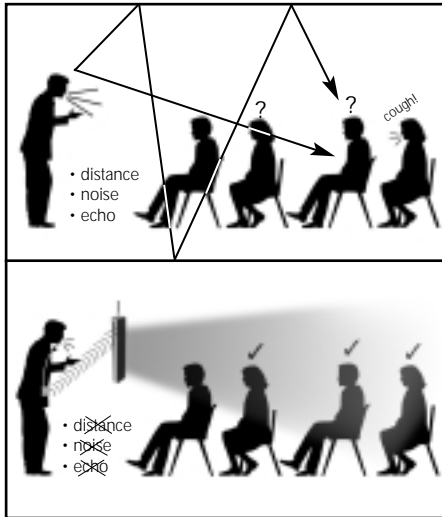

without sound field

with sound field

## setup tips

### IMPORTANT!

Be sure you place your Radium speaker and transmitter units on their charger overnight – for a minimum of 12 hours – before turning the power on and/or using them for the first time. Failing to do so can reduce battery capacity.

### Basic setup tips

**First** – Identify a front corner of the room – the location from where the teacher normally teaches.

**Second** – Take a good look around, paying close attention to power outlet and other electronic equipment locations. Ideally, the speaker should be placed at a 5-foot distance from other electronic equipment, such as computers or radios.

**Third** – Determine whether to mount the speaker on the wall as shown in diagram 1, or place it on a sturdy surface using the T-bar table

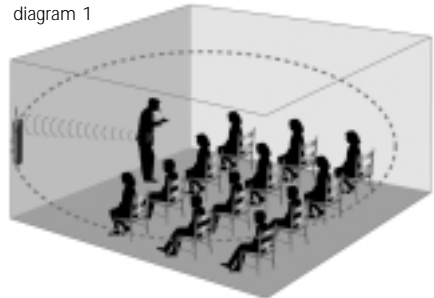

## setup tips (cont'd)

mount stand in diagram 2. In either case, the speaker should be placed at a height of 3 feet/1 meter from the floor, or at level closest to the listener's ears.

**Fourth** – Consider whether other Radium, EasyListener 2, or other radio-based active learning systems are in use in the building, and set transmitter and receiver channels accordingly. Every transmitter in a building should be on its own channel. See diagrams in section [12](#) for guidance.

diagram 2

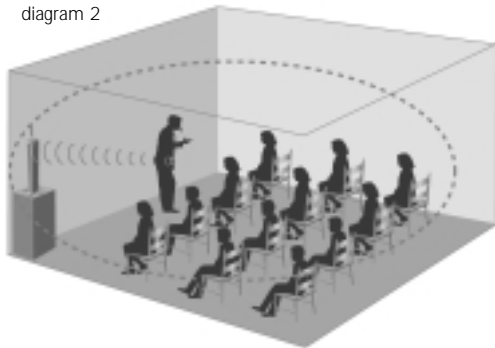

If placing the speaker on a table or surface top, consider the following:

- ***Choose a location that provides easy access for the teacher, and is out of the way of students and main traffic areas.*** The speaker should be placed at least 6 feet/1.8 meters away from where the teacher stands.

## setup tips (cont'd)

- **Choose a table or surface top that is sturdy.**  
Make sure the table or cabinet is structurally solid, sturdy and out of the way of foot traffic.
- **Properly mount and securely fasten the T-bar speaker stand onto the bottom of the speaker.** Make sure the stand is screwed on tightly, and that the speaker does not wobble when in an upright position.

If mounting on the wall, consider the following:

- **The power supply cord needs to reach the wall outlet.** Make sure the power supply is within reach of the speaker from its wall-mounted position.
- **The teacher should be able to reach the controls located on top of the speaker once it's mounted.** Once the volume is set at a comfortable level, the speaker power switch located on the lower right side of the speaker can be easily accessed by the teacher. Follow the instructions on page 28 for setting the volume at the proper level.
- **Never mount the speaker upside down, or horizontally.** The speaker unit must be mounted such that the controls are located at the top of the unit.

## daily operating tips

In the morning –

- **Turn transmitter power 'on' and put microphone on.**
- **Turn speaker column power 'on'.** The speaker should remain plugged into a wall power outlet during the day – with the power in the 'on' position. Turn power switch to the 'off' position at night after each use. The internal battery is not being used while the speaker is plugged into a wall outlet.
- **To operate using the internal battery as a portable system,** simply unplug the speaker before use and plug back in after use – making sure you return power switch to 'off' position while plugged-in and charging. The battery takes 6 hours to reach a full charge; at full charge, the speaker column battery will last up to 8 hours unplugged.

In the evening after each use –

- **Turn transmitter power 'off'**, and place it back onto the charging stand; confirm that the 'charge' indicator light illuminates. Transmitters not in use should always be placed on the charging stand – this is their home base station.
- **Turn speaker column power 'off'**. Leave speaker plugged into wall power outlet, but confirm that the power has been turned 'off'.



## daily operating tips (cont'd)

### Battery care and maintenance tips –

- The speaker battery will last approximately 2 years depending on usage.
- When not in use, leave speaker plugged into wall outlet with power switch in 'off' position.
- Keep speaker away from heating units – use/store in a cool dry place.
- When using speaker battery power (unplugged from wall), always remember to return power switch to 'off' position after use.
- Never mount/use speaker horizontally or upside down. Controls should be accessible from top of unit.
- Plan on buying new NiMH batteries for your transmitter every 12 months. Alkaline batteries can also be used as back-ups, however, the 923C charger will not recharge alkaline batteries. Never attempt to recharge alkaline batteries – this will cause damage to the unit and void the product warranty.
- Remember to charge all batteries overnight before initial use.

## daily operating tips (cont'd)

Do not coil the microphone – since it also acts as your antenna, coiling or wrapping the cord will affect its range and may also reduce its life.

Speak at a normal level – the system is projecting your voice for you.

## parts and accessories included with system

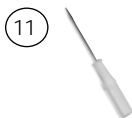
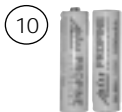

- ① column speaker receiver (920SR)
- ② body-worn transmitter (921T)  
and/or  
handheld transmitter (922T)
- ③ plug-in mic for body-worn transmitter (AT0655 shown)
- ④ charging stand (923C)
- ⑤ power supply, receiver (040-7402-106)
- ⑥ power supply, charging stand (AT0819)
- ⑦ receiver antenna (AT0831)
- ⑧ speaker table stand (AT0823)  
or  
wall mounting bracket (set of 2) (AT0820)
- ⑨ elastic belt (AT0712)
- ⑩ AA rechargeable NiMH batteries (AT0807)
- ⑪ channel changer screwdriver (330-3000-101)
- ⑫ auxiliary input/output cable (AT0532-05)
- ⑬ auxiliary input cable (3.5mm – dual RCA) (300-6332-107)

## 920SR column speaker features (top)

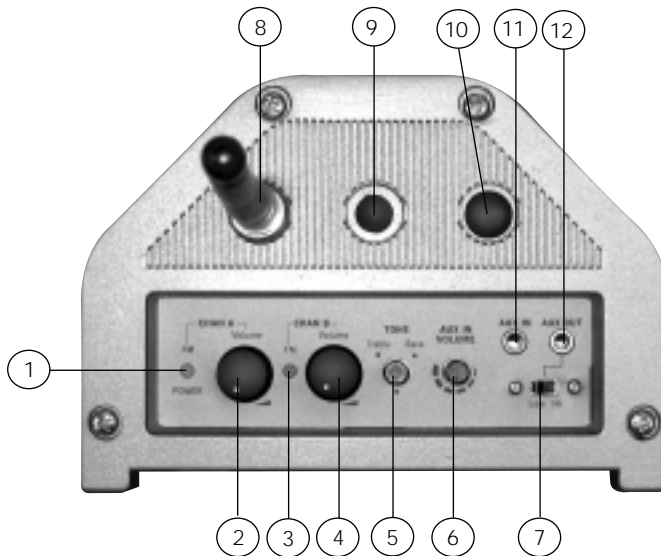

- ① power, low battery, and reception status indicator for channel A
- ② power switch and volume control for channel A
- ③ reception status indicator for channel B
- ④ power switch and volume control for channel B
- ⑤ tone control
- ⑥ aux input volume control
- ⑦ aux output level switch  
**See page 42 for level setting chart**
- ⑧ antenna
- ⑨ wall mount hole
- ⑩ extra antenna hole (not used)
- ⑪ aux input jack (3.5mm, mono)
- ⑫ aux output jack (3.5mm, mono)

## 920SR column speaker features (front and back)

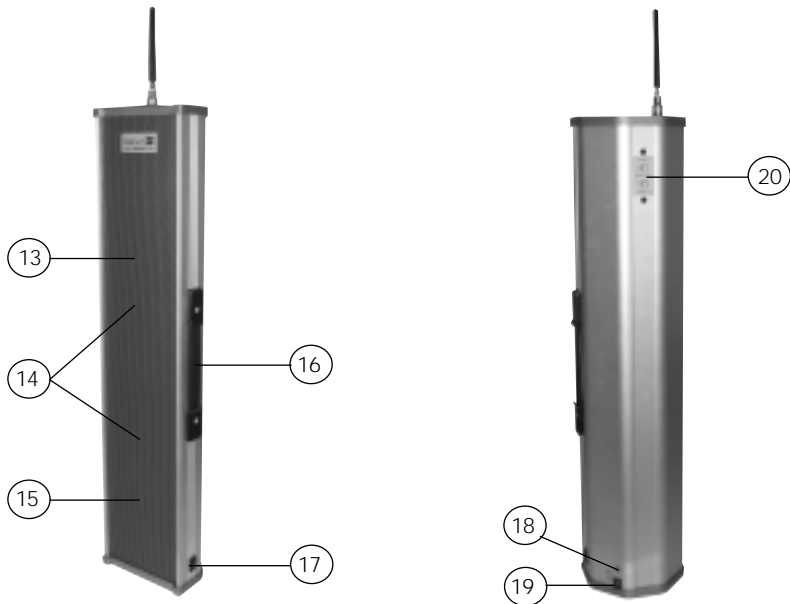

⑬ speaker grille

⑲ power jack

⑭ two built-in speakers

⑳ channel selectors

⑮ internal rechargeable battery  
(non-user removable)

⑯ handle

⑰ main power on/off switch

⑱ power and charging indicator



## 921T body-worn transmitter features

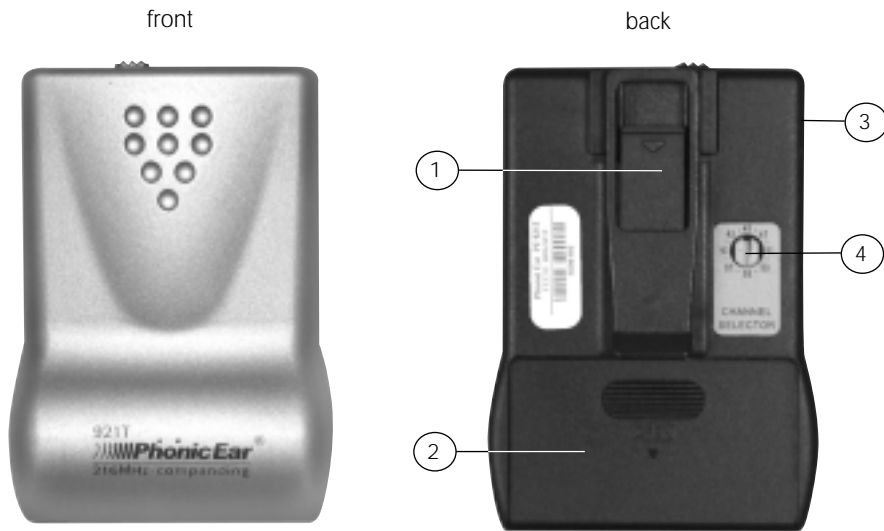

## 921T body-worn transmitter features (cont'd)

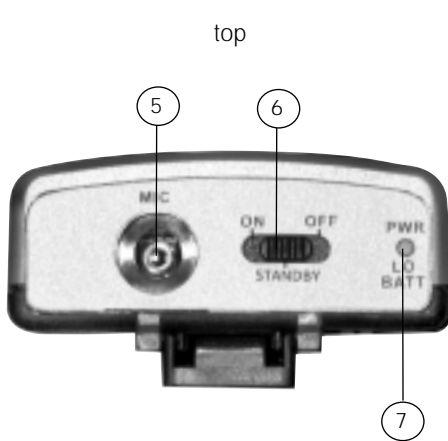

- ① belt clip
- ② battery compartment
- ③ volume control
- ④ channel selector
- ⑤ microphone input (2.5mm)
- ⑥ 3 position power switch
- ⑦ power and low battery indicator light

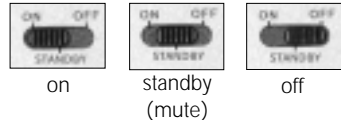

## 922T handheld microphone features

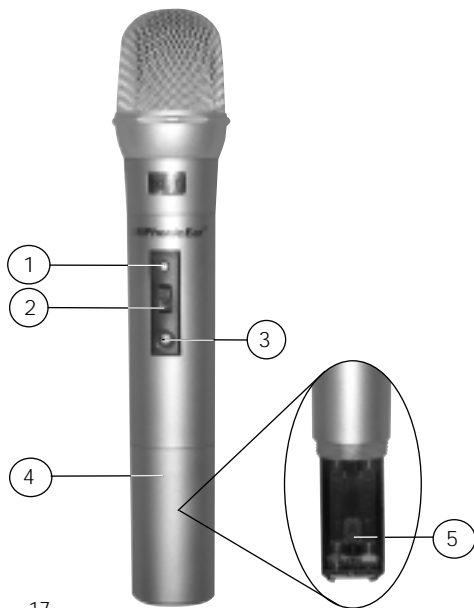

① LED indicator light

② 3 position power switch



on



standby  
(mute)



off

③ channel selector

④ battery compartment

⑤ channel selector key  
(inside battery compartment)

## 923C charging stand features

front

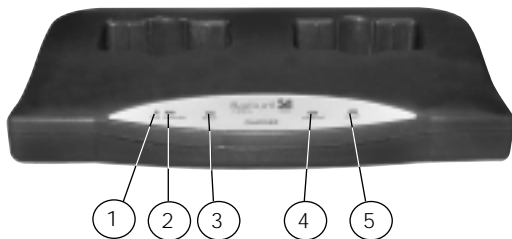

- ① power indicator
- ② pocket 1 charging indicator
- ③ pocket 1 full charge indicator
- ④ pocket 2 charging indicator
- ⑤ pocket 2 full charge indicator

back

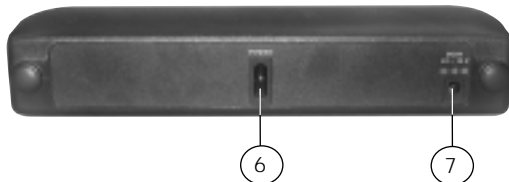

- ⑥ power switch
- ⑦ DC power socket

1

## system setup and operation

### attach antenna

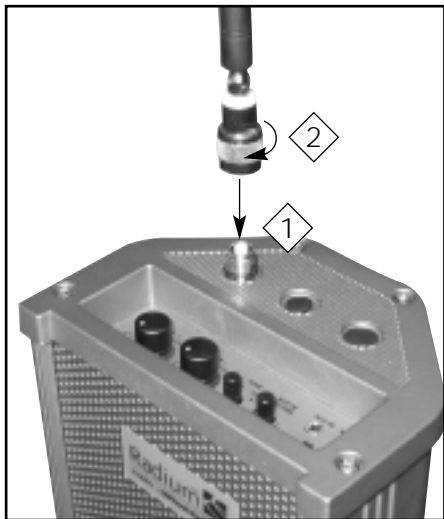

1 Attach antenna to top of speaker

2 Turn metal base of antenna clockwise until secured tightly (do not over-tighten)

2

turn on main power



if using wall outlet

1 Plug power supply into power/charging socket

2 Plug power supply into wall socket

3 Turn speaker on

if using already charged battery

3 Turn speaker on

NOTE: Battery operating time is 5-8 hours.

# 3

## charge battery

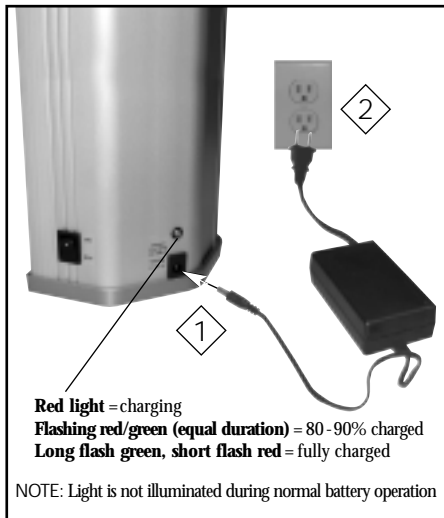

charge nightly after every use

- 1 Plug power supply into power/charging socket
- 2 Plug power supply into wall socket

Recharging time is 8 hours if the battery is completely discharged and 4 to 7 hours if battery is only partially discharged.

NOTE: Battery operating time is 5-8 hours.

4

insert batteries in body-worn transmitter

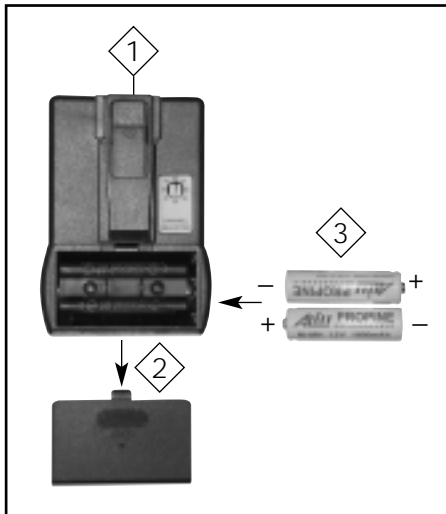

1

Switch power off

2

Remove battery cover  
*(push and slide off)*

3

Insert two AA rechargeable  
NiMH batteries

**WARNING:** Never recharge alkaline batteries! This will cause damage to the unit and will void the product warranty.



5

insert batteries in handheld microphone

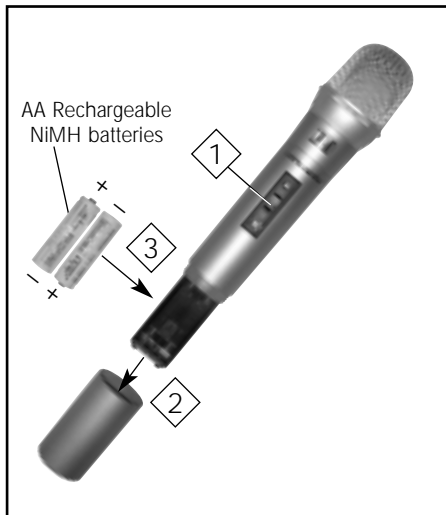

1

Switch power off

2

Remove battery cover  
*(turn counter-clockwise)*

3

Insert two AA rechargeable  
NiMH batteries

**WARNING:** Never recharge alkaline batteries! This will cause damage to the unit and will void the product warranty.

# 6

## charge transmitter(s)

Never attempt to recharge alkaline batteries! This will cause damage to the unit and will void the product warranty.

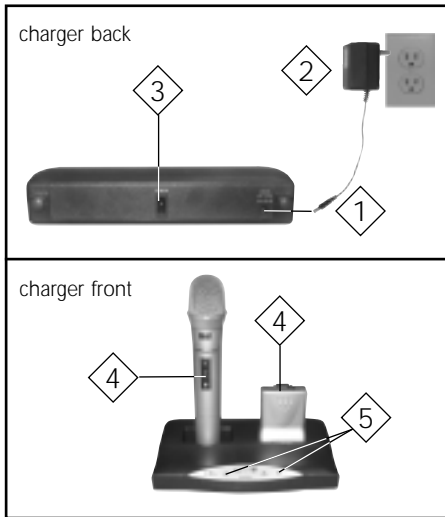

- 1 Plug power supply into power jack on back of charger stand
- 2 Plug power supply (AT0819) into wall socket
- 3 Turn charger on
- 4 Turn transmitters off while charging
- 5 When green charge ready indicator lights, the transmitter batteries are full charged and ready to go. (4 to 5 hours)

7

wait until green charge indicators light (4-5 hours)

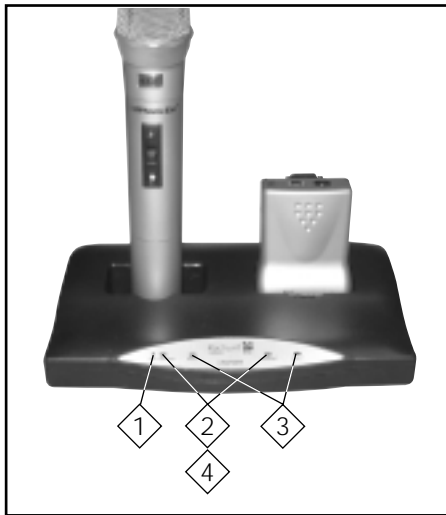

PWR:

**Red light** = charger is turned on



CHARGING:

**Amber light** = units are being charged



READY:

**Green light** = units are fully charged



ERROR:

**Blinking Amber light** = charging error. Improper batteries have been detected. Check your batteries and replace as required. Only NiMH AA batteries can be charged. Unit will not charge disposable Alkaline batteries or NiCad batteries.

8

select channel

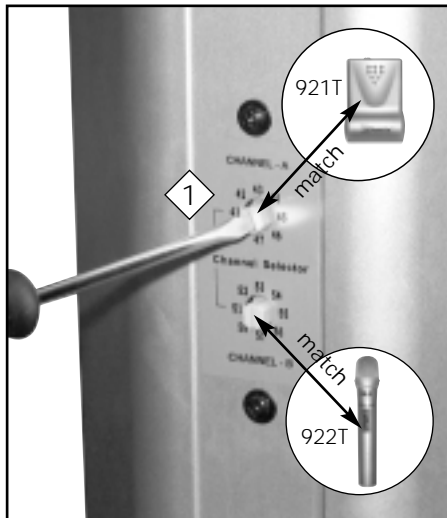

1

Use a screwdriver to adjust the Channel A selector on the back of the speaker to match the channel number of either the 921T and/or the 922T transmitter(s).

**NOTE:** Consider whether other Radium, EasyListener 2, or other radio-based active learning systems are in use in the building, and set transmitter and receiver channels accordingly. Every transmitter in a building should be on its own channel. See diagrams in section [12](#) for guidance.

9

activate receivers

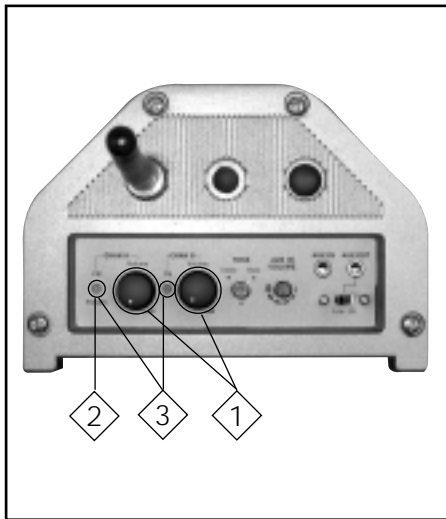

1 Turn receiver on by turning Channel A and/or Channel B volume control knob(s) to the right

2 Check power indicator light (remember that main power must also be on – see [2]):

**Flash red once** = adequate power

**Continuous red** = low battery

**No light** = battery does not have power and requires recharging or power supply is not connected properly

3 Turn on a 921T or 922T transmitter and check FM indicator light(s):

**Green** = receiving FM signal

## 10

## setting FM volume

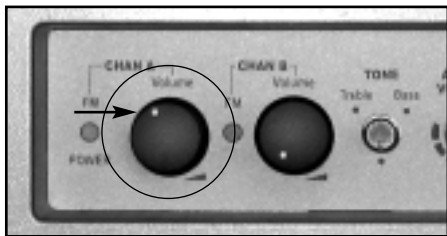

Follow steps **1** or **2** below to adjust FM volume setting to proper level. Two people are needed to set the volume level. It is difficult to hear your own voice and make adjustments to it.

NOTE: The average volume setting is in the 11:00 position (see photo), but may change depending on room acoustics and noise level.

1

With a sound level meter - Take a level reading in the "A" setting in the center of the room during normal classroom activity, and another reading of the teacher's amplified voice (without the class activity). The level of the teacher's voice should be set between 10-15 decibels above room noise level.

2

Without a sound level meter - First, ask someone other than yourself (if you are the teacher) to listen to the amplified voice and make volume adjustments. An ideal volume level is achieved when the listener can hear the amplified voice at a comfortable level and the volume level from the speaker and teacher's mouth is comparable. If you can hear yourself through the loudspeakers, the volume setting may be too high and should be decreased.

**11**

## 920SR speaker placement and mounting speaker positioning

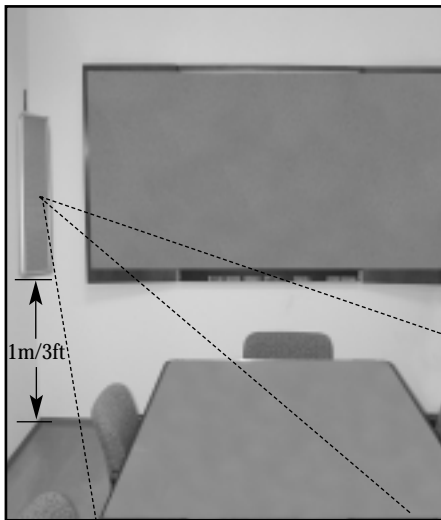

Place speaker in a corner of the room facing listeners. Mount speaker on wall using brackets or place speaker on a surface using a speaker stand. The bottom of the speaker should be about 1 meter/3 feet from the floor. (See setup tips on page 3).

12a

channel mapping: placement diagram for multiple system installations (double channel - 8 rooms total)

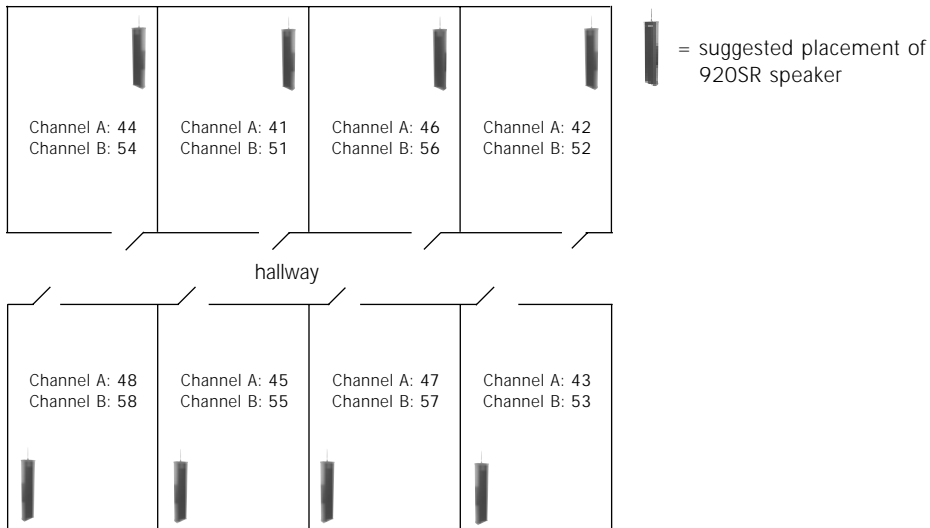



12b

channel mapping: placement diagram for multiple system installations (single channel - 16 rooms total)

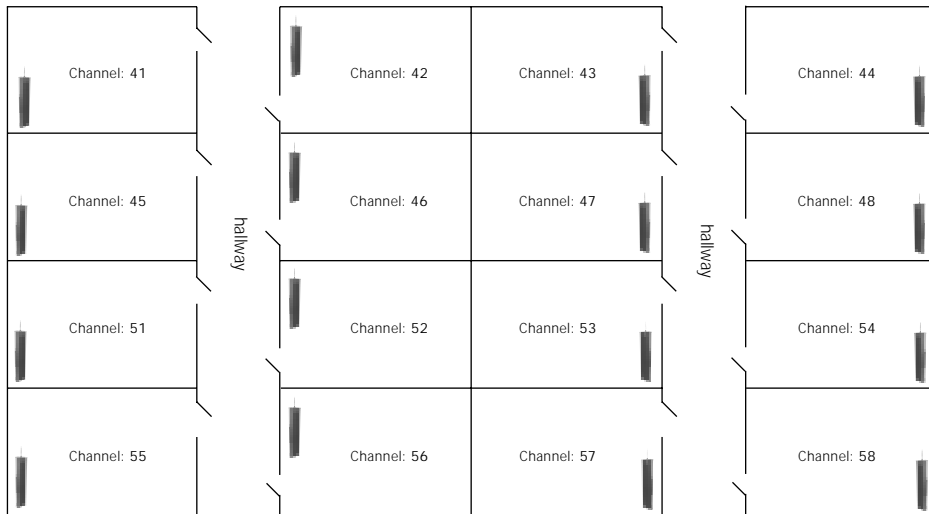

13a

wall mounting (option 1)

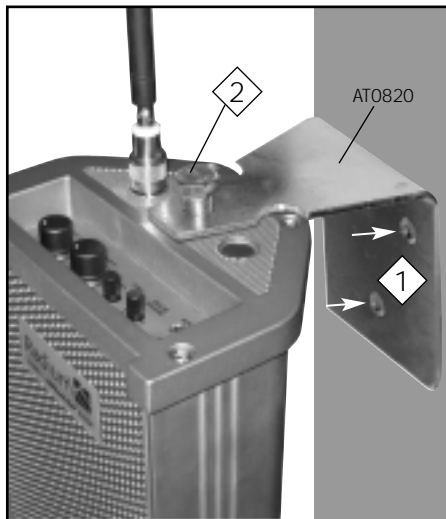

Attach brackets to wall



Screw mounting brackets to top and bottom of speaker

13b

mounting on floor stand (option 2)

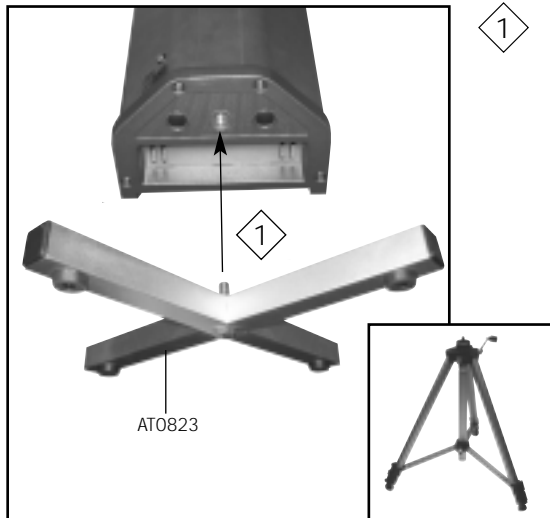

1

Screw speaker stand into hole on bottom of speaker.

- Turn clockwise to tighten
- Turn counter-clockwise to loosen

AT0824 floor stand  
is also available

13c

seal wall mounting hole if using table stand

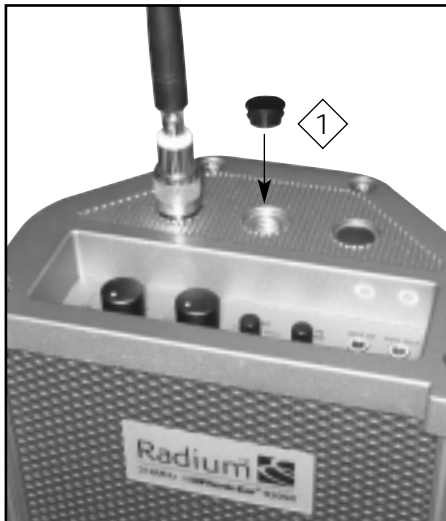

- 1 Place plastic plug into mounting bracket hole on top of speaker to keep out dust

14

## 921T body-worn transmitter operation plug microphone in

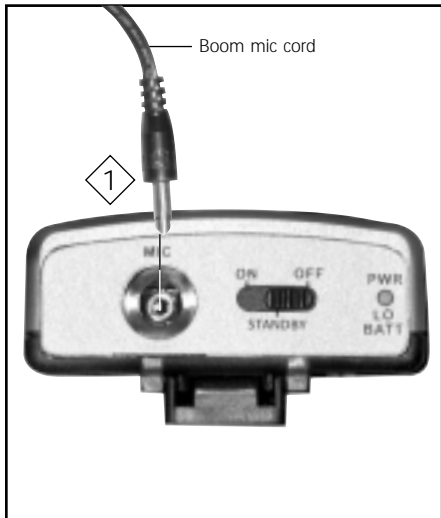

1

Plug microphone cord into  
mic jack on top of body-worn  
transmitter

15

put on microphone and adjust for proper distance from mouth

Maximum distance from mic to mouth is 6 in/(15cm); 3 in/(7.5cm) is ideal.



optimum  
optional  
AT0655 boom mic (two wearing options)  
performance: ★★★★★



AT0814 earhook mic  
performance: ★★★★★



AT0816 collar mic  
performance: ★★★



AT0291-L directional lapel mic  
performance: ★★

16

turn power on

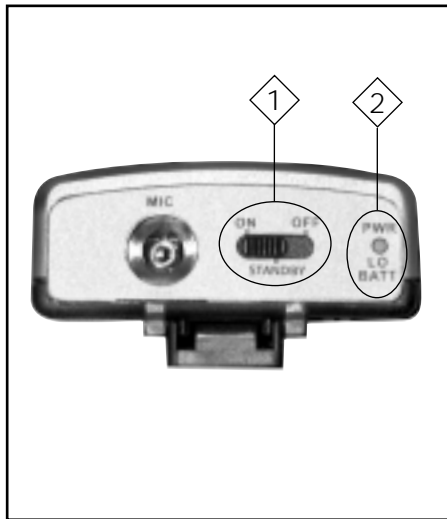

1

Switch power on

2

Check indicator light:

**Continuous green** = adequate power

**Continuous red** = low battery

battery life

NiMH rechargeable AA = 12 hours (approx.)

Alkaline disposable AA = 15 hours (approx.)

**WARNING:** Never recharge alkaline batteries! This will cause damage to the unit and will void the product warranty.

17

adjust transmitter(s) frequency

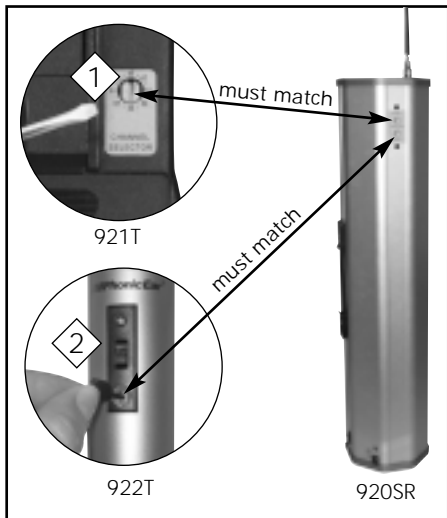

- 1 Use a screwdriver to turn frequency selector to channel number that matches the channel set on column speaker
- 2 If using both body-worn and hand-held transmitters set one transmitter channel to match a Channel A on the speaker column, and the other transmitter channel to match a Channel B channel on the speaker column.

**NOTE:** Never operate two transmitters on the same channel or interference will result. To use two transmitters, set the first to match receiver Channel A and the second to match receiver Channel B.



18

adjust body-worn transmitter volume

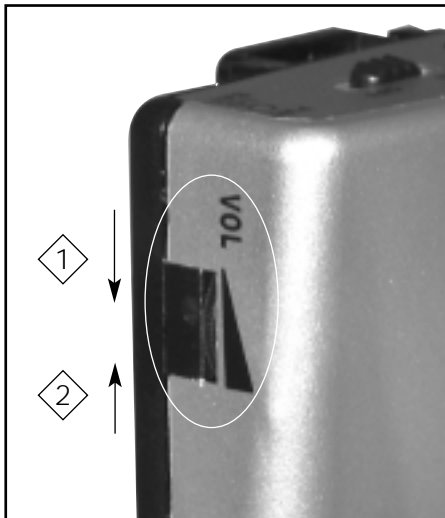

1

Increase transmitter volume for greater mic sensitivity and sound clarity

2

Reduce transmitter volume if feedback occurs

19

activate standby/mute mode

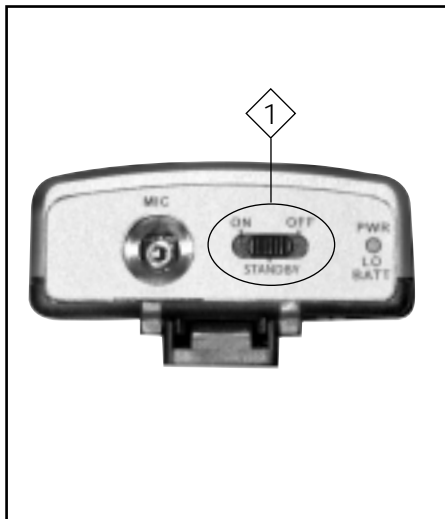

1

Activate standby mode to eliminate white noise when not speaking

**MUTE:** Standby mode can also be used as a microphone/transmitter mute switch. The mute feature allows teachers to have a private conversation without needing to turn the transmitter off.

20

## 922T handheld transmitter operation

turn power on



1

Turn power on by pushing power switch up

21

check indicator light



Check indicator light:

**Continuous green** = adequate power

**Continuous red** = low battery

battery life

NiMH rechargeable AA = 12 hours (approx.)

Alkaline disposable AA = 15 hours (approx.)

**WARNING:** Never recharge alkaline batteries! This will cause damage to the unit and will void the product warranty.

22

remove channel adjustment key

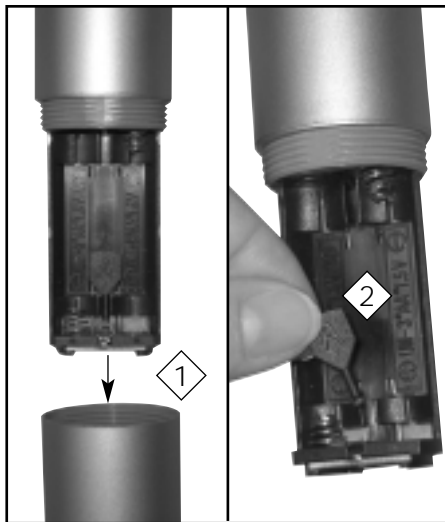

1

Open battery compartment door and  
remove batteries

2

Remove channel adjustment key

23

adjust transmitter channel to match receiver channel

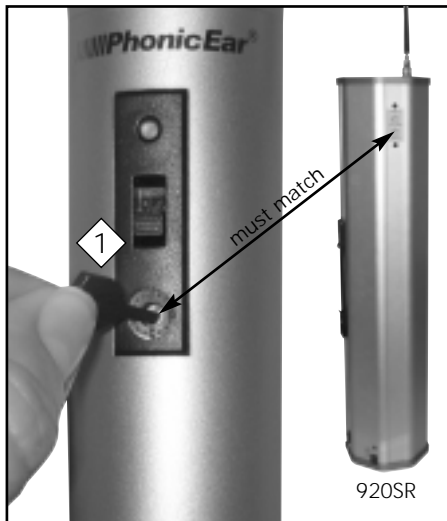

1

Using adjustment key, turn channel frequency selector to channel number that matches the channel set on column speaker

**NOTE:** Never operate two transmitters on the same channel or interference will result. To use two transmitters, set the first to match receiver Channel A and the second to match receiver Channel B.

24

standby mode



1

Activate standby mode to mute voice and eliminate white noise when not speaking

1

25

transmitters that can be used with 920SR receiver/speaker

★★★★ = most compatible    ★ = least compatible

transmitter	compatible (no adaptor cord required)	performance rating	accessory needed	comments
921T Radium	✓	★★★★	none	
922T Radium	✓	★★★★	none	
330T EasyListener 2	✓	★★★★	none	
300TS-216 Sprite	✓	★★★★	none	best when used with AT0655 boom mic
Lexis transmitter (as mic)	✓	★★★★	✓	a) Lexis requires the use of the AT0655R boom mic b) may require use of external antenna for better range (389-02-120-02) c) set microphone to omni mode  d) set sensitivity level to HI
Phonak Campus S TX5	✓	★★★	✓	due to feedback, use of external boom mic from Phonak is recommended
Phonak HandyMic TX3	N/A	N/A	N/A	a) built-in mic prone to feedback b) requires use of external mic, which the HandyMic does not accommodate



26

aux in – connecting to TV, CD, VCR, etc.  
connecting speaker to TV, CD, VCR, etc.

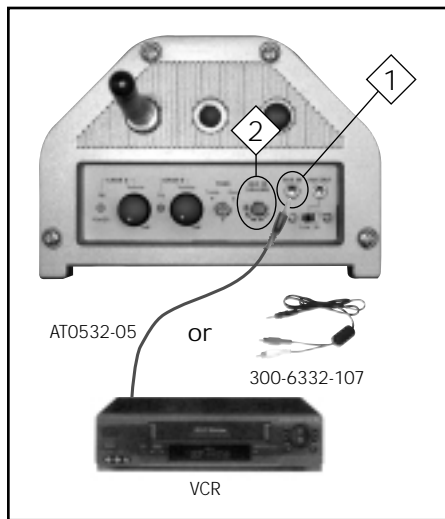

1 Using either the AT0532-05 or 300-6332-107 adaptor cords, connect VCR, TV, CD, computer or other audio source to AUX IN port on top of speaker

2 Use AUX IN VOLUME control to adjust volume

NOTE: AUX IN can be used simultaneously with both Channel A & B.

**27**

**aux out – connecting to personal FM devices**  
connecting to SOLARIS, EASY LISTENER, SPRITE or other transmitter  
(for rebroadcast of audio to students with hearing impairment)

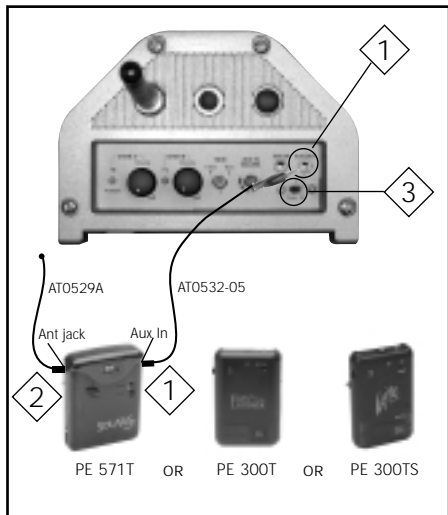

- 1 Connect AT0532-05(ft) cord to AUX input jack of either SOLARIS, EASY LISTENER, SPRITE, or other transmitter. Connect other end of cable to AUX OUT port on top of speaker.
- 2 Connect antenna AT0529A (included with transmitter system) to Mic/Ant jack on transmitter
- 3 Refer to level setting guide on next page to identify proper level for your transmitter

## 28

## aux out transmitter compatibility chart and level setting guide

NOTE: Common transmitters and recommended level settings are shown below. Because the level setting is universal, other transmitters not listed below may be used as well – simply set the aux out level to the position at which the receiver wearer hears a strong distortion-free signal.

product name/part	aux in jack size	aux out level setting
Easy Listener 300T	3.5mm	High
Sprite 300TS	3.5mm	High
Sprite 300TS-216	3.5mm	High
Solaris 571T	3.5mm	High
Lexis 871T transmitter	3.5mm	High
Phonak Campus S TX5	3.5mm	High
Phonak HandyMic TX3	3.5mm†	High
Phonak MicroVox TX2	2.5mm*	High

\* For transmitters with a 3.5mm jack size, simply attach the transmitter to the AT0805 aux out accessory cord. For 2.5mm products, use the aux out adapter plug (310-2544-1341) 

† Requires special adaptor cord provided by Phonak (P/N 52117) and Radio Shack adaptor (P/N 274387).

## additional system accessories

### microphone options

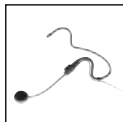

**AT0655**  
behind-the-neck  
boom microphone



**AT0814**  
earhook microphone



**AT0816**  
FM collar microphone  
with mute switch

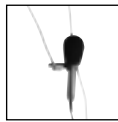

**AT0291-L**  
directional microphone  
with lavalier cord

### receiver accessories



**AT0820**  
wall mounting bracket  
(set of 2)

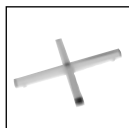

**AT0823**  
speaker table stand



**AT0824**  
speaker floor stand



**AT0822**  
carrying bag



**AT0801**  
aux-box (adds four  
additional audio inputs)

## additional system accessories (cont'd)

### transmitter accessories

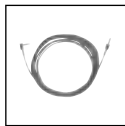

AT0532-15  
auxiliary input/  
output cable  
(3.5mm-dual RCA)  
(15ft/4.6m)



AT0529A  
transmitter antenna



310-2544-1341  
aux-out adaptor plug  
(3.5mm-2.5mm)



AT0807  
AA rechargeable  
NiMH batteries

## troubleshooting

no FM reception (Channel A, Channel B indicator does not have green light)

- Verify the transmitter is turned on
- Verify the frequency number on the transmitter matches the frequency number on receiver
- Verify transmitter batteries are charged
- Verify speaker antenna is connected properly

weak sound from speaker

- Increase volume on the speaker
- Turn up transmitter volume
- Make sure AT0655 boom microphone (or other mic) is being worn correctly

speaker is receiving a signal but no sound is coming out

- Verify microphone is connected properly to transmitter and is working correctly

feedback from speaker

- Turn down the volume on the transmitter
- Turn down the volume on the speaker
- Make sure the person wearing the transmitter is not too close to the speaker
- Move speaker so that it is facing away from presenter and toward listeners
- Make sure AT0655 boom microphone (or other mic) is being worn correctly

## troubleshooting (cont'd)

speaker does not turn on (power indicator does not flash red)

- Verify main power switch on the bottom of the unit is turned on
- Verify Channel A and Channel B volume control knobs are turned on
- Verify power supply is plugged securely into speaker and wall socket
- Verify wall socket works

speaker battery does not charge

- Connect power supply to speaker and charge for four hours. If speaker battery does not hold a charge, send the unit to Phonic Ear Service department for replacement (battery must be replaced after one year of continuous use).

speaker is picking up FM interference or hum

- Check to make sure no other wireless systems are operating on similar frequencies
- Check to make sure the system is not placed too close to a computer
- Check to make sure metal objects are not placed too close to transmitter or speaker (i.e. jewelry, metal shelves)

amber charge light is flashing when I attempt to charge my transmitter

- Replace your batteries with a set of new NiMH cells (AT0807).

## Radium channel numbers and corresponding frequencies

Channel #	Channel A	Channel #	Channel B
41	.216.025 MHz	51	.216.525MHz
42	.216.075MHz	52	.216.575MHz
43	.216.125MHz	53	.216.625MHz
44	.216.175MHz	54	.216.675MHz
45	.216.225MHz	55	.216.725MHz
46	.216.275MHz	56	.216.775MHz
47	.216.325MHz	57	.216.825MHz
48	.216.375MHz	58	.216.875MHz



# product specifications

## two channel column speaker: 920SR

carrier frequency range/ frequencies	216.025 – 216.875MHz 16 total
modulation	FM (F3E)
output power	maximum 36W @ 4Ω x 2
power requirements	110V/240V AC adaptor 15V DC/2A, Battery 12V/2.7A (rechargeable, sealed lead-acid, 1-1.5 year life with continuous usage)
frequency response	100Hz – 9kHz
total harmonic distortion	<2%
system signal-to-noise ratio	>65 dB (at rated output)
inputs	AUX x 1, power & charge
output	AUX x 1 (High: 700 mV/Low: 100mV)
controls	tone, channel A & channel B power/volume, aux volume, high/low output, master power, channel selector

dimensions (WXHxD)	100 x 660 x 145 mm/ 3.9 x 26 x 5.7 in
weight	5kg/11lbs
recharging time	8 hours for initial charging 4 – 7 hours for recharging
battery operating time	5 – 8 hours (continuous operation)
speaker stand	optional table stand (AT0823), floor stand (AT0824), or wall brackets (AT0820)
de-emphasis	75µs
squelch	RSSI

## product specifications (cont'd)

### body-worn transmitter: 921T

carrier frequency range/ frequencies	216.025 –216.875MHz 16 total
modulation	FM (F3E)
total harmonic distortion	<1.5%
frequency response	50Hz to 12KHz
frequency stability	.0005%
maximum modulation	± 25KHz, with level limiting
pre-emphasis	75µs
dynamic range	100dB
operating range	>34m/110ft
dimensions (wxhxd)	65 x 90 x 25 mm/ 2.5 x 3.5 x 1 in
weight	51g/1.8oz
controls	on/standby/off/channel selector/volume
inputs/outputs	2.5mm microphone input jack

battery	NiMH rechargeable (1600mA); alkaline disposable (2AA)
battery life	NiMH rechargeable: 12 hours (approx.) alkaline disposable: 15 hours (approx.)
recharging time	6 hours

## product specifications (cont'd)

### handheld mic transmitter: 922T

carrier frequency range/ frequencies	216.025 – 216.875MHz 16 total (see chart below)
mic	dynamic microphone
antenna	built-in
RF output	15mW
battery	NiMH rechargeable battery; alkaline disposable; 1.5V x 2 AA
battery life	NiMH rechargeable: 12 hours (approx.) alkaline disposable: 15 hours (approx.)
recharging time	6 hours (NiMH batteries)
dimensions (dia x length)	54 x 237 mm/2.1 x 9.3 in
weight	230g/8.1oz
controls	on/standby/off/channel selector

### charging stand: 923C

power supply	AC adaptor (DC 12V/0.5A)
indicator lights	LED green = battery ready LED orange = recharging LED red = power on LED blinking orange = fault (battery bad)
recharging time	NiMH (1300mA): 4 hr
dimensions (wxhxd)	135 x 47 x 230 mm/5.3 x 1.9 x 9 in
weight	360g/12.7oz
controls	on/off switch

## warranty

### time period of warranty

This warranty will go into effect upon the date of purchase and will stay in effect as long as the instrument remains the property of the original owner. EASYLISTENER 2™, VOCALIGHT™ and ONWAVE™ have a 3-year warranty. All other products have a 1 year warranty.

### what is covered by this warranty

Any electronic component, which because of workmanship, manufacturing or design defects, fails to function properly under normal use during the life of this warranty will be replaced or repaired at no charge for parts or labor, when returned to the factory service center. Transportation in is paid by the customer. If it is determined that repair is not feasible, the entire unit may be replaced with an equivalent unit upon mutual agreement of the manufacturer and customer.

### what is not covered by this warranty

This limited warranty does not apply to:

1. Malfunctions resulting from abuse, neglect or accident
2. Instruments connected, installed, used or adjusted in any manner contrary to instructions provided by the manufacturer
3. Consequential damages and damages resulting from delay or loss of this instrument. The exclusive remedy under this warranty is strictly limited to repair or replacement as herein provided
4. Products damaged in transit unless investigated by the shipper and returned to the warrantor with the investigation report
5. Peripheral accessories as itemized within the product specification sheet as applicable, when such items are not returned within 1 year from original purchase
6. Batteries if applicable

## warranty (cont'd)

*Phonic Ear Inc.* reserves the right to make changes in the design or construction of any of its instruments at any time without incurring any obligation to make any changes whatsoever on units previously purchased.

This warranty is in lieu of all other expressed warranties. All expressed and implied warranties will terminate upon the expiration of this written warranty. No representative or person is authorized to represent or assume for us any liability in connection with the sale or use of our products other than as set forth above.

what to do if you have questions

If you have any questions about service, call the service department at 800.227.0735, then press 7.

what to do if you need service

If you require service under the warranty terms, obtain a service order form either online at [www.phonicear.com/support.asp](http://www.phonicear.com/support.asp) or through our U.S. customer service department at 800.227.0735, then press 5 (or +1.707.769.1110 outside the U.S.). Fill the form out completely remembering to include:

1. Description of the problem
2. Your billing address
3. Your shipping address (if different from billing address)
4. Contact name and phone number
5. A P.O. number if the equipment is not under a warranty or service contract

## warranty (cont'd)

Then, carefully package the equipment in the original shipping container **to prevent damage** and send it postpaid to the service center near you:

USA/International:

**Phonic Ear Inc.**

3880 Cypress Drive  
Petaluma, CA 94954-7600  
U.S.A.

In Canada:

**Phonic Ear Ltd.**

10-7475 Kimbel Street  
Mississauga, Ontario  
L5S 1E7 Canada

what to do if you have questions

If you have any questions about service, call the service department at 800.227.0735, then press 7.

about your batteries

To ensure that your batteries are as fresh as possible upon arrival, we have intentionally not installed them in your equipment.

install your batteries in your equipment now, then charge overnight before initial use (see user guide for charging procedure).

avoid battery corrosion

To avoid battery corrosion and damage to your equipment, do not recharge disposable or rechargeable alkaline batteries. **Before charging any Phonic Ear equipment make sure only NiMH rechargeable batteries are installed.** As an added precaution, remove batteries if the equipment will not be used for several weeks.

## regulatory approvals and clearances

### transmitter

This transmitter is authorized by rule under the Low Power Radio Service (47 C.F.R. Part 95) and must not cause harmful interference to TV reception or United States Navy SPASUR installations. You do not need an FCC license to operate this transmitter. This transmitter may only be used to provide: auditory assistance to persons with disabilities, persons who require language translation, or persons in educational settings; health care services to the ill; law enforcement tracking services under agreement with a law enforcement agency; or automated maritime telecommunications system (AMTS) network control communications. Two-way voice communications and all other types of uses not mentioned above are expressly prohibited.

This device may not interfere with TV reception or federal government radar, and must accept any interference received, including interference that may cause undesired operation.

**IMPORTANT NOTE:** To comply with FCC RF exposure compliance requirements, only use supplied antenna that is sold with this transmitter. Use of any other antenna which has not been approved by the manufacturer will violate FCC rules and regulation and void the user's authority to operate this device. This device and its antenna(s) must not be co-located or operating in conjunction with any other antenna or transmitter.

## regulatory approvals and clearances (cont'd)

receiver: part 15, subpart B

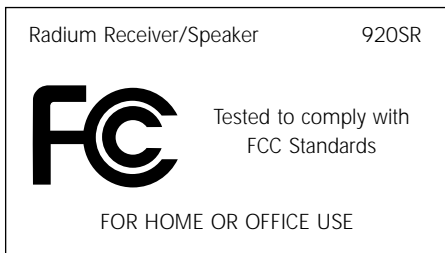

This equipment has been tested and found to comply with the limits for a Class B digital device, pursuant to Part 15 of the FCC Rules. These limits are designed to provide reasonable protection against harmful interference in a residential installation. This equipment generates, uses and can radiate radio frequency energy and, if not installed and used in accordance with the instructions, may cause harmful interference to

radio communications. However, there is no guarantee that interference will not occur in a particular installation. If this equipment does cause harmful interference to radio or television reception, which can be determined by turning the equipment off and on, the user is encouraged to try to correct the interference by one or more of the following measures:

- Reorient or relocate the receiving antenna.
- Increase the separation between the equipment and receiver.
- Connect the equipment into an outlet on a circuit different from that to which the receiver is connected.
- Consult the dealer or an experienced radio/TV technician for help.



## regulatory approvals and clearances (cont'd)

### FCC notes

The Radium sound field system is approved by the FCC (Federal Communications Commission). The use of the system may be governed by specific FCC rules and FCC licensing or notifications may be required. Consult your local FCC office for detailed information.

Phonic Ear FM receivers and FM transmitters, when required, are approved by the Federal Communications Commission (FCC) in the U.S. and Industry Canada. Other government approvals are available upon request. (Other international regulations may also apply.)

Any changes or modifications made to any government-approved element of this instrument, without the express approval of Phonic Ear Inc in writing, could void the user's authority to operate those elements of the system.

### Part 95

This transmitter is authorized by rule under the Low Power Radio Service (47 CFR Part 95) and must not cause harmful interference to TV reception or United States Navy SPASUR installations. You do not need an FCC license to operate this transmitter. This transmitter may only be used to provide auditory assistance to persons with disabilities, persons who require language translation, or persons in educational settings; health care services to the ill; law enforcement tracking service under agreement with a law enforcement agency; or automated maritime telecommunication system (AMTS) network control communications. Two-way voice communications and all other types of uses not mentioned above are expressly prohibited.

## regulatory approvals and clearances (cont'd)

This device may not cause interference and must accept any interference received, including interference that may cause undesired operation.

These devices may not interfere with TV reception or Federal Government radar.

### IC notes

This Class B digital apparatus complies with Canadian ICES-003.

Cet appareil numérique de la classe B est conforme à la norme NMB-003 du Canada.

The term "IC:" before the radio certification number only signifies that Industry of Canada technical specifications were met.

If TV channel 13 is used in the area, the installer shall reduce or adjust the RF radiated power so that near-by TV channel 13 receivers do not receive radio interference from the system installed. Suggestions: A test with a TV receiver equipped with "rabbit-ear antenna" and tuned to channel 13 should be conducted, at the perimeter of the users' intended coverage area and not over-lapping other user's areas without the latter's consent. If this does not solve the problem, a channel near the 217 MHz edge and not near 216 MHz should be tried.



This product has been cleared by the U.S. Food and Drug Administration for use by persons with normal hearing and hearing impairment.

u.s.a. 800.227.0735, then press 5 • canada 800.263.8700 • international +45 3917 7101

---

© 2005 Phonic Ear Inc. Phonic Ear and the names of Phonic Ear products are trademarks or registered trademarks of Phonic Ear Inc. in the U.S. and other countries. Product specifications and accessories subject to change without notice. 821-7403-101/Rev. D/4724 0205

Download from [Www.Somanuals.com](http://Www.Somanuals.com). All Manuals Search And Download.

## Free Manuals Download Website

<http://myh66.com>

<http://usermanuals.us>

<http://www.somanuals.com>

<http://www.4manuals.cc>

<http://www.manual-lib.com>

<http://www.404manual.com>

<http://www.luxmanual.com>

<http://aubethermostatmanual.com>

Golf course search by state

<http://golfingnear.com>

Email search by domain

<http://emailbydomain.com>

Auto manuals search

<http://auto.somanuals.com>

TV manuals search

<http://tv.somanuals.com>