



RadioShack[®]

www.radioshack.com

MPA-40 20-Watt PA Amplifier



Owner's Manual

Please read before using this equipment.

Contents

Features	3
Preparation	4
Presetting the Controls	4
Choosing a Location	4
Making Connections	4
Speakers	5
Speaker Phasing	5
Determining Total Speaker Impedance	6
Connecting Speakers	7
One Speaker	7
Two or More Speakers Without Transformers	7
Multiple Speakers with Transformers	9
Controls and Operation	11
Troubleshooting	12
Care and Maintenance	13
Replacing Fuses	13
DC Cable	13
Amplifier	13
Specifications	14
Notes	15

© 2000 Tandy Corporation.
All Rights Reserved.

RadioShack and RadioShack.com are registered trademarks used by Tandy Corporation.

□ Features

Your RadioShack 20-Watt PA Amplifier gives you 20 watts of solid power for your PA system. Its wide frequency response easily handles amplification of voice and music. It operates on either 120 volts AC or 12 volts DC power so you can use it anywhere you want to deliver special announcements or play music with great sound.

Its features include:

Microphone Jacks — let you connect up to two dynamic microphones.

Input Jacks — let you connect auxiliary equipment, such as a CD player, tape deck, or receiver, for music and special effects.

Individual Microphone Controls — let you separately adjust the volume of each microphone.

Master Volume Control — lets you adjust the overall sound level.



Auxiliary Volume Control — lets you adjust the volume of the connected equipment.

Tone Control — lets you customize the sound to suit your personal preferences, depending on the acoustics, speakers, and sound source.

Five Speaker Terminals — make speaker connection easy.

Your amplifier is ETL listed to UL standards and meets all applicable FCC standards.

WARNING: To reduce the risk of fire or shock hazard, do not expose this product to rain or moisture.

	CAUTION	
RISK OF ELECTRIC SHOCK. DO NOT OPEN.		
CAUTION: TO REDUCE THE RISK OF ELECTRIC SHOCK, DO NOT REMOVE COVER OR BACK. NO USER-SERVICEABLE PARTS INSIDE. REFER SERVICING TO QUALIFIED PERSONNEL.		



This symbol is intended to alert you to the presence of uninsulated dangerous voltage within the product's enclosure that might be of sufficient magnitude to constitute a risk of electric shock. Do not open the product's case.



This symbol is intended to inform you that important operating and maintenance instructions are included in the literature accompanying this product.

□ Preparation

PRESETTING THE CONTROLS

Warning: A sudden high output from the amplifier could damage your hearing or the speakers connected to the amplifier's output.

To avoid accidentally overdriving a channel or prematurely amplifying an audio input, set all the amplifier's front-panel controls to their lowest settings.

To avoid sudden audio from the input sources, be sure all audio devices are turned off before you connect them to the amplifier.

CHOOSING A LOCATION

Choose a location with adequate ventilation. Do not place the amplifier on thick carpeting or cushions (which can restrict the air flow) or near a heat source, such as a heat vent or radiator (which can cause the amplifier to overheat).

□ Making Connections

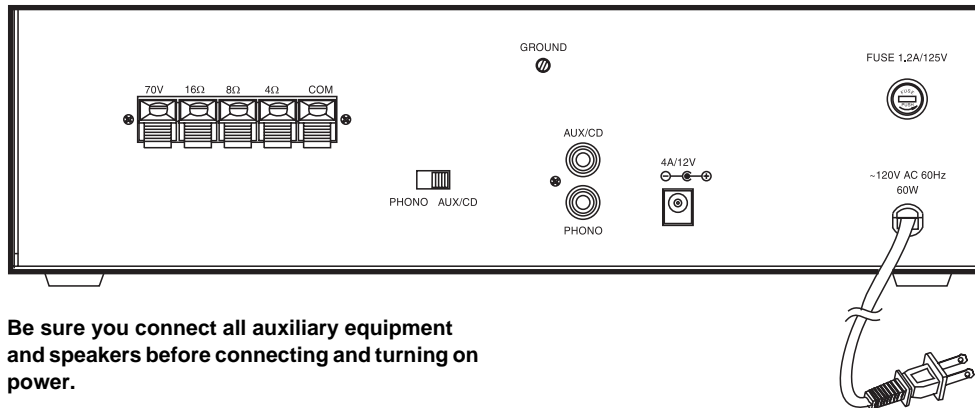

Be sure you connect all auxiliary equipment and speakers before connecting and turning on power.

AUX/CD Input Jack — connect any high-level sound source (such as a tape deck, CD player, or receiver). To connect a stereo audio source to this jack, use a shielded Y-adapter (not supplied; available at your local RadioShack store).

PHONO Input Jack — connect a turntable with a moving magnetic cartridge. To

avoid sound distortion, do not connect a high-level audio input source to this jack.

GROUND Screw — connect the ground wire (usually black or green) from your turntable to this screw to avoid a low-frequency hum. You can also use this screw to ground any other system connection.

PHONO/AUX/CD Switch — select the input source. Even if you connected auxiliary equipment to both the **PHONO** and **AUX/CD** input jacks, you can use only one source at a time.

Speaker Push Terminals — press the appropriate tab to open a terminal. Insert the end of a speaker wire into the opening, then release the tab to close the terminal and secure the wire (see “Connecting Speakers” on Page 7).

AC Power Cord — to use AC power, simply plug this attached cord into a standard AC outlet.

4A/12V (4-Amp/12-Volt DC Power) Jack — connect the supplied DC power

cable’s barrel plug to this jack if you want to temporarily power the amplifier from your vehicle’s 12-volt battery. Then connect the cable’s other end to your vehicle’s 12-volt accessory socket (such as a cigarette-lighter socket).

Cautions:

- Your vehicle must have a negative-ground electrical system. If you are not sure it does, check with your vehicle dealer.
- Unplug the AC power cord before you connect the DC power cable. Likewise, disconnect the DC power cable before you plug in the AC power cord.

□ Speakers

SPEAKER PHASING

Phasing is the direction the speaker cone moves with reference to the polarity of the connection wires. Proper phasing is important when you use more than one speaker in the same room or area. Out-of-phase speakers can lose up to one-half of their potential volume, and can have a significantly decreased bass effect.

Speakers are in phase if all the speaker cones move in the same direction when an equal signal is applied. Phasing is correct if you observe the correct polarity (+ to + and – to –) when connecting the speakers.

Most speaker terminals are color-coded or have a mark that indicates the terminal’s polarity. Usually, terminals with positive polarity are red or have a plus symbol (+), and terminals with negative polarity are black or have a minus symbol (–). If the speaker terminals are unmarked, follow these steps to determine their polarity.

1. Remove about 1 inch of insulation from both ends of a short piece of wire (not supplied; available at your local RadioShack store). Then twist the exposed wire to secure all its strands.
2. Connect one end of the wire to one of the speaker terminals.

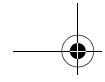

3. Touch the positive end of a 1.5-volt flashlight battery to the speaker terminal that does not have the wire attached to it.
4. Touch the negative end of the battery with the loose end of the wire attached to the other speaker terminal. Note the direction of the cone movement — inward or outward.
5. If the speaker cone moves outward, the speaker terminal where you touched the positive end of the battery is positive. Mark that terminal with a + and mark the other terminal with a –.

If the speaker cone moves inward, the speaker terminal with the wire attached that touched the negative end of the battery is positive. Mark that terminal with a + and mark the other terminal with a –.

6. Remove the wire.

Repeat Steps 2–6 for each speaker with unmarked terminals you plan to connect to the amplifier.

DETERMINING TOTAL SPEAKER IMPEDANCE

Caution: A total speaker impedance that is higher than 16 ohms (Ω) or lower than 4 ohms can damage your amplifier or speakers. Be sure to make the proper connections.

Before you connect speakers to the amplifier, you must determine the total speaker impedance. In determining the total speaker impedance, you must first determine if your speakers are connect-

ed in series, parallel, or series/parallel combined.

Note: We recommend that you use speakers that are rated the same (for example, all 8-ohm speakers) for all series or parallel connections.

- Speakers are connected in series when the first speaker's positive terminal is connected to the next speaker's negative terminal. Determine the total impedance of speakers connected in series by adding up the individual impedances of all the connected speakers.

For example, if you want to connect two 8-ohm speakers in series, add 8 (the impedance of one speaker) plus 8 (the impedance of the other speaker) for a total speaker impedance of 16 ohms.

- Speakers are connected in parallel when all their negative terminals are connected together and all their positive terminals are connected together. For speakers rated the same, find the total impedance of speakers connected in parallel by dividing the impedance of one speaker by the number of speakers.

For example, if you want to connect two 8-ohm speakers in parallel, divide 8 (the impedance of one speaker) by 2 (the number of speakers) for a total speaker impedance of 4 ohms.

- If you connect more than two speakers using only series or only parallel connections, the total impedance might exceed the amplifier's maximum impedance (16 ohms) or fall below its minimum impedance (4 ohms).

For example, if you connect four 8-ohm speakers:

–In series, the total impedance is 32 ohms ($8 + 8 + 8 + 8 = 32$). This exceeds the maximum rating.

–In parallel, the total impedance is 2 ohms ($8 \div 4 = 2$). This falls below the minimum rating.

You can arrive at a proper total impedance by combining series and parallel connections.

CONNECTING SPEAKERS

You need speakers and wire to complete the connections to your amplifier. Use 16-gauge wire or larger. For parallel connections or those involving more than two speakers, you also need wire connectors. All of these items are available at your local RadioShack store.

Remove about 1 inch of insulation from both ends of each wire. Then twist the exposed wire to secure all its strands.

Connect the speaker wire to the amplifier by pressing down on the appropriate push terminal tab and inserting the end of the twisted wire into the terminal's hole. Then release the tab to secure the wire.

You can connect one or more 4-, 8-, or 16-ohm speakers, with or without transformers, between the amplifier's output and the speakers' input. To ensure equal volume from each speaker, all the connected speakers should have the same impedance rating.

One Speaker

Connect the speaker's negative (–) terminal to the amplifier's **COM** (common) terminal. Then connect the speaker's positive (+) terminal to the amplifier's terminal that matches the speaker's impedance. For example, if you have an 8-ohm speaker, connect the speaker's positive terminal to the amplifier's 8-ohm terminal.

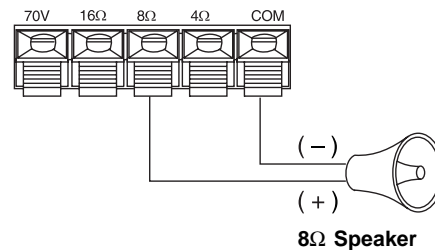

Two or More Speakers Without Transformers

We recommend connections without transformers if the length of the connecting wires between the amplifier and the speakers is 50 feet or less.

When making connections without transformers, all the speakers must have the same impedance rating to ensure equal volume from each speaker. When there is more than one speaker in a sound system, you must determine the total impedance of the speakers before

you can make the correct connection. The total impedance of all the speakers must match one of the amplifier's output terminals (4Ω , 8Ω , or 16Ω).

Speakers in Series

1. To determine the total impedance of speakers connected in series, add the impedance of all the speakers.

For example, if you want to connect two 8-ohm speakers in series, add 8 (the impedance of one speaker) plus 8 (the impedance of the other speaker) for a total speaker impedance of 16 ohms.

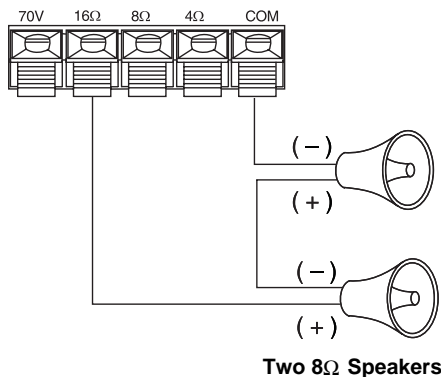

2. Connect the first speaker's positive (+) terminal to the second speaker's negative (-) terminal.
3. Connect the first speaker's negative (-) terminal to the amplifier's **COM** terminal.
4. Connect the second speaker's positive (+) terminal to the amplifier's terminal that matches the total speaker impedance (16Ω , in this example).

Speakers in Parallel

1. To determine the total impedance of speakers connected in parallel, divide the impedance of one speaker by the number of speakers.

For example, if you want to connect two 8-ohm speakers in parallel, divide 8 (the impedance of one speaker) by 2 (the number of speakers) for a total speaker impedance of 4 ohms.

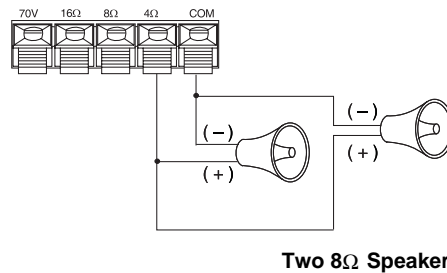

2. Connect the speakers' negative (-) terminals together.
3. Connect the speakers' positive (+) terminals together.
4. Connect the speakers' negative (-) terminals to the amplifier's **COM** terminal.
5. Connect the speakers' positive (+) terminals to the amplifier's terminal that matches the total speaker impedance (4Ω , in this example).

Series and Parallel Combined

If you must hook up more than two speakers, you might have to use a combination of series and parallel connections to get a total impedance that matches one of the amplifier's terminals.

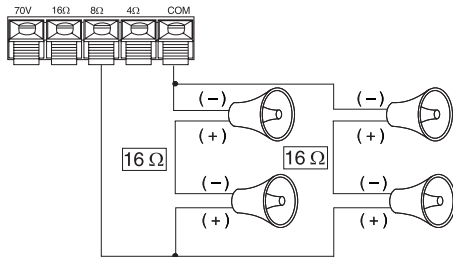

Four 8Ω Speakers

If you connect four 8-ohm speakers in series, the total impedance is 32 ohms ($8 + 8 + 8 + 8 = 32$). This exceeds the maximum rating.

If you connect these speakers in parallel, the total impedance is 2 ohms ($8 \div 4 = 2$). This falls below the minimum rating.

You can arrive at a proper total impedance by combining series and parallel connections.

1. Group speakers into pairs.
2. Connect each pair of speakers in series.

For example, the total impedance of each pair of 8-ohm speakers is 16 ohms ($8 + 8 = 16$).

3. Connect the pairs of speakers in parallel.
4. To determine the total impedance of speakers connected in serial and parallel combined, divide the impedance of one pair of speakers by the number of pairs.

For example, if you want to connect four 8-ohm speakers in serial and parallel combined, divide 16 (the

impedance of one pair of speakers) by 2 (the number of speaker pairs) for a total speaker impedance of 8 ohms.

5. Connect the negative (-) terminals of all pairs of speakers to the amplifier's **COM** terminal.
6. Connect the positive (+) terminals of all pairs of speakers to the amplifier's terminal that matches the total speaker impedance (**8Ω**, in this example).

Multiple Speakers with Transformers

For complex multiple-speaker arrangements that require many speakers and long runs of connecting wire, we recommend you use a line transformer (not supplied), available at your local RadioShack store.

Note: When running lengths of wire longer than 50 feet, use wire that is heavier than 16 gauge.

There are several advantages to using transformers.

- You can connect speakers with different impedances without causing differences in output between the speakers.
- You can add or remove a speaker without having to recalculate the entire system's impedance.
- You can reduce signal loss when you use speaker wire over 50 feet long.

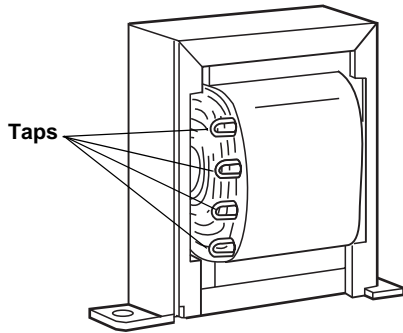

You need a separate transformer for each speaker.

Line transformers have several connectors called taps.

The primary taps (on one side of the transformer) are the inputs and are rated in watts. The secondary taps (on the opposite side of the transformer) are the outputs and are rated in ohms.

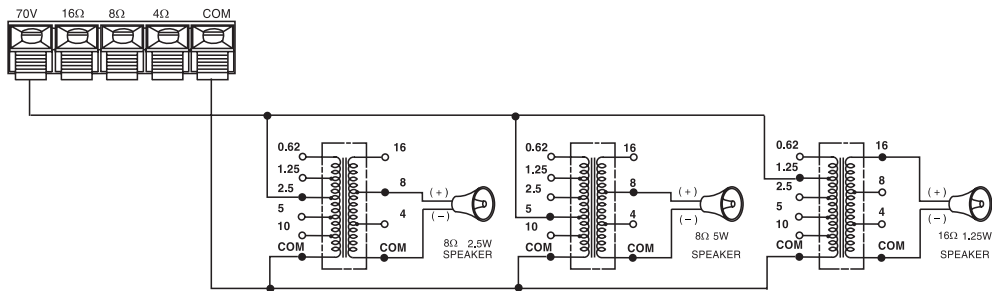
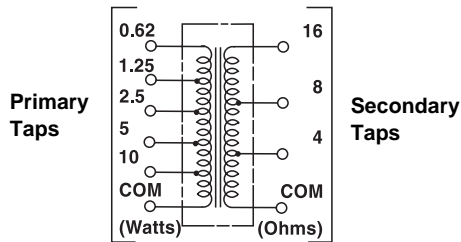

Cautions:

- Before you connect the speakers, be sure the total wattage of the primary taps you intend to use does not exceed the amplifier's maximum 20-watt output power rating.
- Avoid multiple connections to the amplifier's **70V** and **COM** terminals.

Follow these steps to make the connections.

1. Connect a wire from the amplifier's **70V** terminal to the transformer's primary tap that matches your speaker's wattage rating.

Note: Usually, the wattage connections on the primary side of the transformer are the same for all speakers. If you want a particular speaker to have a higher volume level, use a higher wattage tap on the primary side of its transformer.

2. Connect a wire from the amplifier's **COM** terminal to the COM taps on the transformer's primary side.

3. Connect a wire from the speaker's positive (+) terminal to the transformer's secondary tap that matches the speaker's total impedance (4, 8, or 16 ohms).
4. Connect a wire from the speaker's negative (-) terminal to the COM tap on the transformer's secondary side.

▣ Controls and Operation

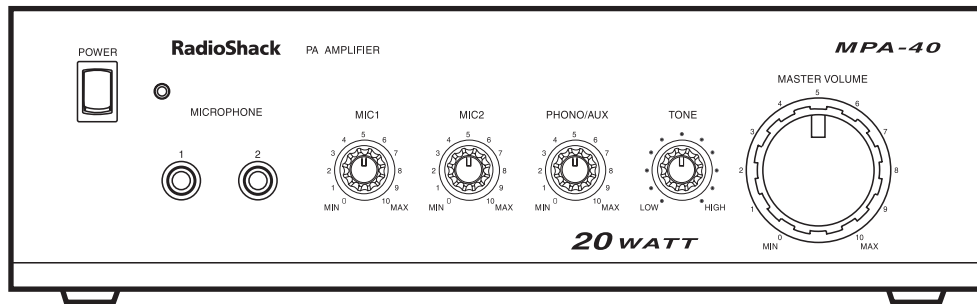

MICROPHONE 1 and 2 Inputs — connect any standard dynamic microphones.

POWER Switch and Indicator — press the bottom half of the switch to turn on the amplifier. The indicator lights. Press the top half of the switch to turn off the amplifier. The indicator goes off.

MASTER VOLUME Control — controls the overall loudness level of all sources equally. With the amplifier turned on and the audio input source turned on (and set to play, if needed), set this control to its mid-range setting (5). Adjust this control again after adjusting the source mixing controls.

Caution: Be careful not to raise the volume level too high. Doing so might overload the system.

MIC 1 and MIC 2 Source Mixing Controls — adjust the input level for each of

the two microphones to get the proper volume and balance.

PHONO/AUX Source Mixing Control — adjusts the input level of the **PHONO** or **AUX/CD** sound source for the best volume and balance.

TONE Control — adjusts the sound quality according to the speakers, sound source, and room acoustics. Turn **TONE** toward **LOW** to adjust the sound toward a low-frequency tone, or toward **HIGH** to adjust it toward a high-frequency tone.

Notes:

- Leaving **TONE** set to **HIGH** produces a flat, unadjusted tone.
- If feedback occurs, turn **TONE** toward **LOW** or turn down the volume.

□ *Troubleshooting*

If you should run into difficulties, check the wiring of the system. Are there any short circuits in the speaker wiring? Have you provided adequate ventilation? Did you calculate speaker impedance correctly?

Be sure microphones and connecting cables are not defective.

Be sure you are using large enough speaker wire. You should always use 16-gauge (or larger) wire. The longer the run of speaker wire, the heavier the gauge should be.

If you have feedback problems, reposition your microphones and speakers, or adjust **TONE** or **MASTER VOLUME** to a lower setting.

If the amplifier does not work at all, check the fuse on the rear panel. If it is blown, replace it with one of the same size and type (see "Replacing Fuses" on Page 13).

If you are operating the unit from a 12-volt DC power source, check the fuse in the supplied cable that connects to your vehicle's 12-volt accessory socket. If the fuse is blown, replace it with a 4-amp 125-volt fuse (see "Replacing Fuses" on Page 13).

If you cannot solve the problem, contact your local RadioShack store for assistance.

□ **Care and Maintenance**

To enjoy your amplifier for a long time:

- Keep the amplifier dry. If it gets wet, wipe it dry immediately.
- Use and store the amplifier only in normal temperature environments.
- Handle the amplifier gently and carefully. Don't drop it.
- Keep the amplifier away from dust and dirt.
- Wipe the amplifier with a damp cloth occasionally to keep it looking new.

Modifying or tampering with the amplifier's internal components can cause a malfunction and invalidate its warranty. If your amplifier is not performing as it should, take it to your local RadioShack store for assistance.

REPLACING FUSES

DC Cable

The supplied cable is equipped with a 4A 125V fuse (in line) to protect your amplifier from voltage surges and abnormal conditions. If the power indicator does not light when you press **POWER**, check the fuse and, if necessary, replace it with one of the same size and type.

To replace the fuse, unscrew the tip of the cigarette-lighter plug. Then remove the old fuse and insert the new fuse. Secure the fuse by reattaching the plug's tip.

Amplifier

The power fuse protects your amplifier from power (voltage or current) surges when operating it from an AC power source. If the **POWER** indicator does not light when you press **POWER**, check the fuse and replace it with one of the same size and type. (A spare fuse is taped to the back of the amplifier.)

Follow these steps to replace the amplifier's fuse.

1. Unplug the amplifier's power cord.
2. Using a flat-blade screwdriver, push and turn the fuse holder's cap counterclockwise until the fuse holder pops out.
3. Remove the fuse holder and replace the fuse.
4. Slide the fuse holder back in place then, using a flat-blade screwdriver, push and turn the fuse holder's cap fully clockwise to secure it.

□ Specifications

Output Power at 1 kHz, 10% THD	20 Watts
THD at 1W, 1 kHz Low-Pass Filter	
MIC1	1%
MIC2	1%
AUX CD	1%
PHONO	1%
Input Sensitivity at 10% THD, 1 kHz	
MIC1	2.5 mV
MIC2	2.5 mV
AUX CD	150 mV
PHONO	3.5 mV
Signal-to-Noise Ratio (Input Shorted) with 30 kHz Low-Pass Filter	
MIC1	60 dB
MIC2	60 dB
AUX CD	65 dB
PHONO	65 dB
Frequency Response at 8 ohms, 1W	
MIC1	130 Hz–20 kHz
MIC2	130 Hz–20 kHz
AUX CD	130 Hz–20 kHz
PHONO	100 Hz 12 dB 10 kHz–13 dB
Hum and Noise at 8 ohms	
at Master Volume Minimum	1 mV
at Master Volume Maximum	10 mV
Tone Control (High Cut at 10 kHz)	–15 dB
Power Requirement	120V AC 60 Hz
Dimensions (HWD)	$3^{15}/_{16} \times 12^{3}/_{4} \times 10^{5}/_{8}$ Inches (99.5 × 324 × 270 mm)
Weight	9 lb (4.08 kg)

Specifications are typical; individual units might vary. Specifications are subject to change and improvement without notice.

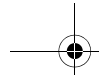

Notes

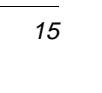
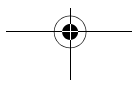
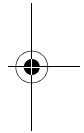
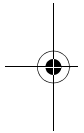

Limited One-Year Warranty

This product is warranted by RadioShack against manufacturing defects in material and workmanship under normal use for one (1) year from the date of purchase from RadioShack company-owned stores and authorized RadioShack franchisees and dealers. EXCEPT AS PROVIDED HEREIN, RadioShack MAKES NO EXPRESS WARRANTIES AND ANY IMPLIED WARRANTIES, INCLUDING THOSE OF MERCHANTABILITY AND FITNESS FOR A PARTICULAR PURPOSE, ARE LIMITED IN DURATION TO THE DURATION OF THE WRITTEN LIMITED WARRANTIES CONTAINED HEREIN. EXCEPT AS PROVIDED HEREIN, RadioShack SHALL HAVE NO LIABILITY OR RESPONSIBILITY TO CUSTOMER OR ANY OTHER PERSON OR ENTITY WITH RESPECT TO ANY LIABILITY, LOSS OR DAMAGE CAUSED DIRECTLY OR INDIRECTLY BY USE OR PERFORMANCE OF THE PRODUCT OR ARISING OUT OF ANY BREACH OF THIS WARRANTY, INCLUDING, BUT NOT LIMITED TO, ANY DAMAGES RESULTING FROM INCONVENIENCE, LOSS OF TIME, DATA, PROPERTY, REVENUE, OR PROFIT OR ANY INDIRECT, SPECIAL, INCIDENTAL, OR CONSEQUENTIAL DAMAGES, EVEN IF RadioShack HAS BEEN ADVISED OF THE POSSIBILITY OF SUCH DAMAGES.

Some states do not allow limitations on how long an implied warranty lasts or the exclusion or limitation of incidental or consequential damages, so the above limitations or exclusions may not apply to you.

In the event of a product defect during the warranty period, take the product and the RadioShack sales receipt as proof of purchase date to any RadioShack store. RadioShack will, at its option, unless otherwise provided by law: (a) correct the defect by product repair without charge for parts and labor; (b) replace the product with one of the same or similar design; or (c) refund the purchase price. All replaced parts and products, and products on which a refund is made, become the property of RadioShack. New or reconditioned parts and products may be used in the performance of warranty service. Repaired or replaced parts and products are warranted for the remainder of the original warranty period. You will be charged for repair or replacement of the product made after the expiration of the warranty period.

This warranty does not cover: (a) damage or failure caused by or attributable to acts of God, abuse, accident, misuse, improper or abnormal usage, failure to follow instructions, improper installation or maintenance, alteration, lightning or other incidence of excess voltage or current; (b) any repairs other than those provided by a RadioShack Authorized Service Facility; (c) consumables such as fuses or batteries; (d) cosmetic damage; (e) transportation, shipping or insurance costs; or (f) costs of product removal, installation, set-up service adjustment or reinstallation.

This warranty gives you specific legal rights, and you may also have other rights which vary from state to state.

RadioShack Customer Relations, 200 Taylor Street, 6th Floor, Fort Worth, TX 76102

We Service What We Sell

12/99

RadioShack
A Division of Tandy Corporation
Fort Worth, Texas 76102

32-2001
811081640B
02A00
Printed in China

Free Manuals Download Website

<http://myh66.com>

<http://usermanuals.us>

<http://www.somanuals.com>

<http://www.4manuals.cc>

<http://www.manual-lib.com>

<http://www.404manual.com>

<http://www.luxmanual.com>

<http://aubethermostatmanual.com>

Golf course search by state

<http://golfingnear.com>

Email search by domain

<http://emailbydomain.com>

Auto manuals search

<http://auto.somanuals.com>

TV manuals search

<http://tv.somanuals.com>