

Cat. No. 19-1104  
**OWNER'S MANUAL**

Please read before using this equipment.

# **HTX-400**

## **Mini Handheld 70-Centimeter FM Amateur Transceiver**



**RadioShack®**

# FEATURES

---

Your RadioShack HTX-400 Mini Handheld 70-Centimeter FM Amateur Transceiver is compact and lightweight, making it easy to carry almost anywhere. The crystal controlled circuitry provides accurate and stable frequency selection, making it an ideal choice for your amateur communications needs.

**Note:** You must have a Technician Class or higher Amateur Radio Operator's License, and a call sign issued by the FCC, to legally transmit using this transceiver. Transmitting without a license carries heavy penalties. Getting a license is easier than ever. See "Introduction to Amateur Radio" on Page 7 for more information.

Here are some of your transceiver's features.

**Up To 1 Watt Output** — the transceiver transmits at 200 mW output when powered by internal alkaline batteries, or at 1 Watt output when powered by an external 9-volt power source.

**CTCSS** (Continuous Tone Coded Squelch System) **Subaudible Tone** — both encodes and decodes 47 subaudible tones to help reduce interference from other nearby systems operating on the same frequency.

**Repeater Offset** — lets you select the appropriate offset value to match a local repeater.

**Scan** — the transceiver scans the frequency range and the memory locations for transmissions.

**Power Save** — conserves battery power when the transceiver is not transmitting or receiving.

**Programmable Frequency Steps** — let you set the frequency increment for tuning or scanning to 5, 10, 12.5, 15, 20, 25, 50 kHz, or 1 MHz steps.

©1999 Tandy Corporation.  
All Rights Reserved.

RadioShack and Adaptaplug are registered trademarks used by Tandy Corporation.

---

---

**Paging Tones**— you can set the radio to play a short, selectable paging tone when it transmits, and sound the same tone when it receives a signal.

**Signal Strength Indicator** — a graduated bar shows the relative strength of the received signal.

**Time-Out Timer** — lets you set a maximum transmission time interval from 0 to 16½ minutes in 10-second increments.

**Busy Channel Lock Out** — prevents transmitting while the selected channel is receiving a signal.

**TX Delay** — reduces squelch tail when communicating using CTCSS.

**Scan Delay** — delays the restart of scanning when the radio locks onto a channel.

**Earphone Jack and External Microphone Jack** — let you connect an optional earphone, external microphone, or combination headset, for more flexible operation.

**External Power Jack** — lets you use an external power source for maximum output.

**30 Memory Locations** — let you store up to 30 frequencies and other settings.

**Back Light** — makes your transceiver easy to operate in low-light situations.

**Key Lock** — lets you lock the transceiver's keys to prevent accidentally changing settings.

We recommend you record your transceiver's serial number here. The number is on the transceiver's back panel.

Serial Number \_\_\_\_\_

---

---

## MANUAL CONVENTIONS

Your transceiver's buttons perform multiple functions. The abbreviation or symbol for a function is printed on, below, or above each button.

To activate certain transceiver features, you must press **FUNC** (function) and another button at the same time. Those key combination instructions are printed as the first button name, +, then the second button name. For example, **FUNC+LOCK** means hold down **FUNC** while you press **LOCK**.

Button names are printed in small, bold, capital letters such as **BEEP** or **SC**. Words, symbols, and numbers that appear on the display are printed using a distinctive typeface, such as **446.100** or **BUSY**.

## FCC INFORMATION

This device complies with Part 15 of the FCC Rules. Operation is subject to the following two conditions: (1) This device may not cause harmful interference, and (2) this device must accept any interference received, including interference that may cause undesired operation.

# CONTENTS

---

<b>Introduction to Amateur Radio .....</b>	<b>7</b>
<b>Preparation .....</b>	<b>9</b>
Power Sources .....	9
Using Internal Batteries .....	9
Testing Internal Batteries .....	10
Using AC Power .....	11
Using Ni-Cd or Ni-MH Battery Power .....	11
Using Vehicle Battery Power .....	12
Connecting the Antenna .....	13
Attaching the Belt Clip .....	13
Attaching the Wrist Strap .....	14
Connecting a Microphone/Speaker .....	14
<b>Using the Menus .....</b>	<b>16</b>
Using the HTX-400's Menus .....	16
<b>A Quick Look at the Controls .....</b>	<b>19</b>
<b>A Quick Look at the Display .....</b>	<b>22</b>
<b>Operation .....</b>	<b>23</b>
Turning on the HTX-400 .....	23
Selecting Frequencies (Direct Tuning) .....	23
Receiving Transmissions .....	24
Temporarily Opening Squelch .....	24
Transmitting .....	25
<b>Understanding Repeaters .....</b>	<b>26</b>
Setting the Repeater Offset Frequency .....	27
Turning Duplex Operation On and Off .....	27
Setting the Repeater Offset Direction .....	28
Reversing the Transmit and Receive Frequencies .....	28
<b>Memory Operation .....</b>	<b>29</b>
Storing a Transmit/Receive Frequency .....	29
Recalling Memories .....	30
Clearing A Single Memory .....	30
Using the Calling-Frequency Memory .....	31

---

---

<b>Scanning Operation .....</b>	<b>32</b>
Scanning for Active Frequencies .....	32
Using Scan Delay .....	32
Scanning Standard Memory Locations .....	32
Setting A Memory Location to Always Skip During Scanning .....	33
Temporarily Locking Out (Skipping) Locations During Memory Scanning .....	34
<b>Continuous Tone Coded Squelch System Features .....</b>	<b>35</b>
Tone Paging .....	37
Sending Paging Tones .....	37
<b>Other Special features .....</b>	<b>38</b>
Changing the Transmit Frequency Range .....	38
Locking the Keypad .....	38
Lighting the Display .....	38
Turning the Key Tone On and Off .....	39
Checking the Current Memory Settings .....	39
Setting the Frequency Step .....	39
Power Save .....	40
Time-Out Timer .....	40
Reducing Squelch Tail .....	41
Busy Channel Lockout .....	41
<b>Troubleshooting .....</b>	<b>42</b>
<b>Care and Maintenance .....</b>	<b>43</b>
Using the Keypad Diagnostic .....	44
Resetting the HTX-400 .....	44
<b>Specifications .....</b>	<b>45</b>

# INTRODUCTION TO AMATEUR RADIO

---

Your transceiver is the perfect first radio for anyone entering the exciting world of amateur radio, as well as a great additional transceiver for the experienced amateur radio operator. Your transceiver opens a door for you to the world from almost anywhere! All you need is an Amateur Radio Operator's License (Technician Class or higher) issued by the Federal Communications Commission (FCC). If you do not have a license, it is easier than ever to get one, and help from licensed operators is available. Here are a few tips to help you get started.

You can turn on your transceiver and scan the entire band to hear what is going on; **however, do not attempt to transmit until you get your license.** If you transmit without a license, you are in violation of federal law that can lead to severe penalties. Note that ham operators take the FCC rules very seriously and want nothing to do with "bootleggers" — their term for people who operate without a license.

Find out if there is a ham radio club in your area. Most clubs welcome newcomers and are glad to help you get your license. There are thousands of clubs across the country, so there is probably one in or near your community. The staff at your local RadioShack store often can help you locate a club.

If you do not hear anyone talking about a local club as you listen to local transmissions, write to the American Radio Relay League (ARRL) at the following address to find out how to contact a local affiliate. The ARRL is the national organization representing amateur radio in the United States. The league has more than 150,000 members. Most are ham operators, or members in the process of obtaining their license.

The American Radio Relay League  
225 Main Street  
Newington, CT 06111

*<http://www.arrl.org>*

---

---

Start studying for the license exams. Do not be intimidated by the word “study,” because most people can go from knowing absolutely nothing about amateur radio to passing the Novice and Technician written exams in less than a month.

The exams test your knowledge of basic radio regulations and elementary radio theory. Many clubs hold license classes which can be a fun and easy way to learn about amateur radio. There are good books, cassette tapes, computer programs, and many other study aids available. Your local RadioShack store sells *FCC License Preparation* study guides for amateur radio operator licenses. While you are no longer required to learn Morse code for a Technician Class license, we encourage you to learn it anyway so you can advance to higher levels of operating privileges.

There is no fee to take the Novice exam. As soon as you pass the Novice exam, you can immediately take the Technician exam. There is a small fee required for taking the Technician exam. All license level tests are administered by a three-member Volunteer Examiner Team. Contact the ARRL for a schedule of exam opportunities in your area.

The Technician Class license lets you use the HTX-400 to communicate directly with other operators, and use repeaters for distant communication.

Amateur radio is a great hobby that has enriched the lives of millions of people all over the world. The ARRL would be glad to hear from you if you need more information or would like to join!



# PREPARATION

---

## POWER SOURCES

You can operate your transceiver from any of three power sources:

- internal batteries
- AC power (using an optional power supply and DC adapter)
- vehicle battery power (using an optional DC adapter)

### Using Internal Batteries

Your transceiver can use two AA batteries (not supplied) for power. For the best performance and longest life, we recommend RadioShack alkaline batteries.

#### Cautions:

- Use only fresh batteries of the required size and recommended type.
- Do not mix old and new batteries, different types of batteries (standard, alkaline, or rechargeable), or rechargeable batteries of different capacities.

Follow these steps to install batteries.

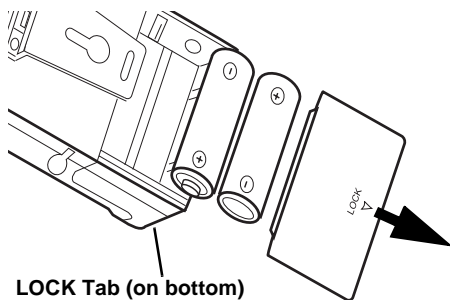

1. Move the **LOCK** tab in the opposite direction of the arrow marked on the bottom of the transceiver.

- 
2. Press down and slide the battery compartment cover in the direction of the arrow marked on the cover.
  3. Put the batteries into the compartment and on top of the attached ribbon, according to the polarity symbols (+ and -) marked inside the compartment.
  4. Replace the cover and slide the **LOCK** tab to secure the cover.

## Testing Internal Batteries

When you turn on the HTX-400, **BAT** appears briefly and the graduated bar (the signal strength meter) next to **BAT** indicates the battery strength. If the batteries are weak, the graduated bar shows less than 4 boxes. The battery symbol (  ) constantly indicates the battery strength. When only one or two bars appear inside the battery strength indicator, replace both batteries as soon as possible.

**Warning:** Dispose of old batteries promptly and properly. Do not burn or bury them.

**Caution:** If you do not plan to use the transceiver with batteries for a two week period, remove the batteries. Batteries can leak chemicals that can destroy electronic parts.

---

---

## USING AC POWER

You can operate the HTX-400 from AC power using a regulated power supply capable of supplying 13.8 VDC at least 1A and a vehicle power adapter (see “Using Vehicle Battery Power” on Page 12). The supply should also have an accessory power socket into which the DC-to-DC power adapter fits. If your power supply does not have an accessory power socket, you can either wire the power cord directly to your power supply or add an accessory power socket to the supply. Suitable connectors, power supplies, power cords, and sockets are available at your local RadioShack store.

The following illustration shows how to connect a typical power supply, a DC-to-DC power adapter, and the HTX-400.

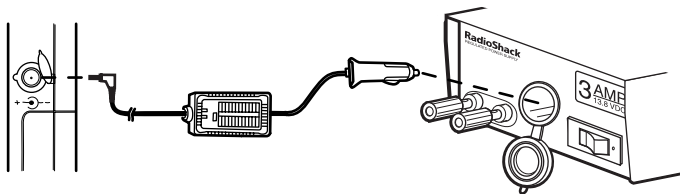

## USING NI-CD OR NI-MH BATTERY POWER

You can use either Ni-Cd or Ni-MH batteries to power your HTX-400; however, you cannot recharge these batteries while they are inside the HTX-400. You can use a separate external charger for recharging the batteries outside the radio. Your local RadioShack store carries a selection of suitable batteries and chargers.

**Note:** As these batteries provide less voltage than that typically supplied by alkaline batteries, expect less transmitting output power when you use the HTX-400 with Ni-Cd or Ni-MH battery power.

---

---

## USING VEHICLE BATTERY POWER

You can power the HTX-400 from a vehicle's 12V power source (such as cigarette-lighter socket) using an 9-volt, 900 mA DC-to-DC power adapter and a size I Adaptaplug<sup>®</sup> (neither supplied) with TIP set to **+**. Both are available at your local RadioShack store.

### Cautions:



You must use a power source that supplies 9V DC and delivers at least 900 mA. Its center tip must be set to positive and its plug must fit the HTX-400's **DC 9V** jack. Using an adapter that does not meet these specifications could damage the HTX-400 or the adapter.

- Always connect the DC adapter to the HTX-400 before you connect it to the power source. When you finish, disconnect the adapter from the power source before you disconnect it from the HTX-400.

Follow these steps to operate the HTX-400 from a vehicle's battery power.

1. Insert the Adaptaplug into the HTX-400's **DC 9V** jack.
2. Plug the other end of the adapter into the cigarette-lighter socket in the vehicle.

---

---

## CONNECTING THE ANTENNA

Place the threaded base socket of the supplied antenna over the antenna connector on top of the transceiver and turn the antenna clockwise to tighten it. Turn it clockwise to remove it.

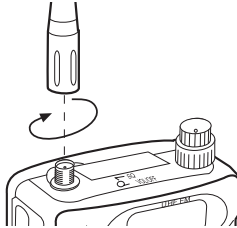

**Caution:** Do not over-tighten the antenna

**Note:** You can connect an external antenna to the HTX-400 using an SMA-to-PL-259 adapter. This adapter, as well as suitable antennas, are available through your local RadioShack store.

## ATTACHING THE BELT CLIP

Use a Phillips screwdriver and the two supplied screws to attach the supplied belt clip to your transceiver. Do not overtighten the screws.

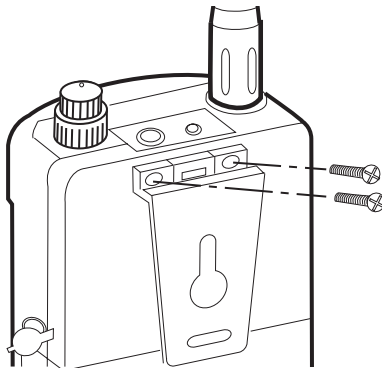

---

---

## ATTACHING THE WRIST STRAP

To attach the supplied wrist strap to the top of the belt clip, thread the strap's small loop through the opening in the top of the clip. Then insert the longer loop through the smaller loop and pull on the strap until the loop is tight.

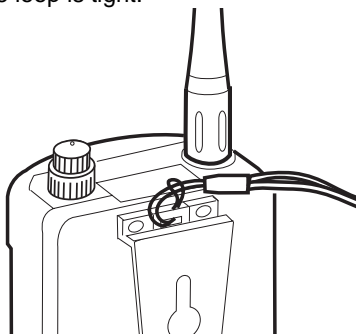

## CONNECTING A MICROPHONE/ SPEAKER

You can connect an external communications headset (consisting of a microphone and speaker) to the transceiver so you can use it privately. Lift the hinged, rubber dust cover from the **MIC** and **SPK** jacks on the top of the transceiver, then insert the plug of an optional voice activated headset with microphone, or an optional communication headset, into the jacks.

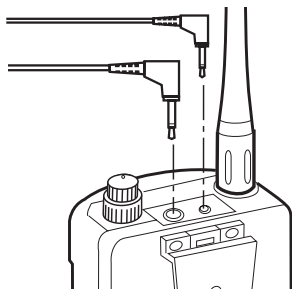

---

**Caution:** Use only microphone and speaker accessories that do not share a common ground for the speaker and the microphone. Doing otherwise might damage the transceiver.

**Note:** Inserting a headset's plug automatically disconnects the internal speaker.

You can also connect an optional mono earphone to the **SPK** jack. This lets you use the transceiver's push-to-talk button to transmit as usual. Your local RadioShack store carries a wide selection of suitable communications headsets, earphones, and separate components.

The following schematic diagram shows the typical wiring for a suitable external mic and speaker.

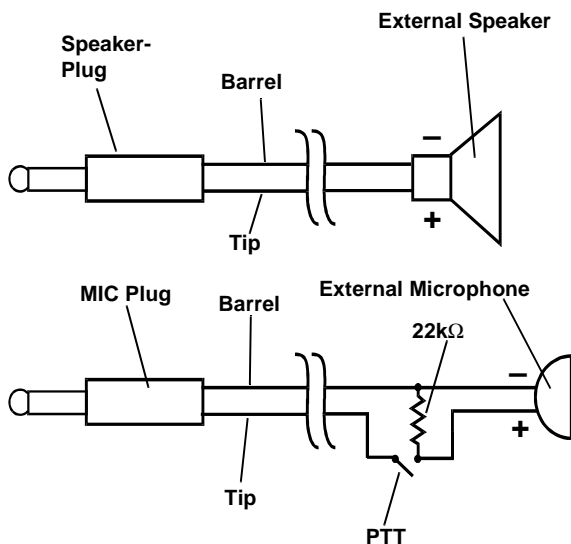

# USING THE MENUS

---

## USING THE HTX-400'S MENUS

The HTX-400 provides two menus to access its features, the Main Menu and the Tone Set Menu. To see details about each operation, refer to the page number in the following chart.

To access the Main Menu, hold down **FUNC** while turning on the HTX-400. (The **CS** option appears). Hold down **FUNC** then repeatedly press **▼** or **▲** to step through the other options. Release **FUNC** and press **▲** or **▼** to change an option's setting.

Main Menu Options	Setting ( ) = default setting	Description	Page
<b>CS</b> Frequency Step	.0050(MHz), .0100, (.0125), .0150, .0200, .0250, .0500, 1.000	Sets the increment for scanning the band.	39
<b>bCLO</b> Busy Channel Lockout	(Off) On	Prevents transmitting while receiving a signal.	41
<b>t.dY</b> Transmit Delay Time	Off (On)	Prevents squelch tail.	41
<b>sd</b> Scan Delay Time	1 to 30 seconds (5)	Sets the scanning restart time.	32



Main Menu Options	Setting ( ) = default setting	Description	Page
tot Time out Timer	(Off) On 10-990 seconds	Limits transmit time.	40
PS Power Save	(Off) On	Cycles power (PS flashes) to the receiver section to conserve batteries. The circuit remains off then turns on briefly to check for an incoming signal.	40
r Repeater Offset	0.00 – 8.00 MHz in 50kHz steps. (5.00)	Sets the offset in 50 kHz steps between the repeater's transmit and receive frequencies.	27

The Tone Set Menu lets you set features that relate to sound and the CTCSS tones. To access these settings, turn on the HTX-400 then hold down **FUNC** and press **T.SET**. (The tone option appears.) Press **FUNC** + ▲ or ▼ to select the option, then ▲ or ▼ to change the setting.

<b>Tone Set Option</b>	<b>Setting ( ) = default setting</b>	<b>Description</b>	<b>Page</b>
<b>tone</b> Subaudible Tone	(Off) On	Lets the HTX-400 transmit and receive the Subaudible Tone (CTCSS) frequencies so you can listen only to other units with the same tone.	35
<b>rC</b> Receive Tone	See the table on Page 36. (67.0)	Lets you select one of 47 different receiving subaudible tones or turn the feature off.	35
<b>tC</b> Transmit Tone	See the table on Page 36. (67.0)	Lets you select one of 47 different subaudible tones or turn the feature off.	35
<b>MEL</b> Tone Paging	(1), 2, 3, 4, 5	Lets you select a tone to receive or transmit.	37

# A QUICK LOOK AT THE CONTROLS

Most of the controls of the HTX-400 have multiple functions. Use the following chart to review the function of each control.

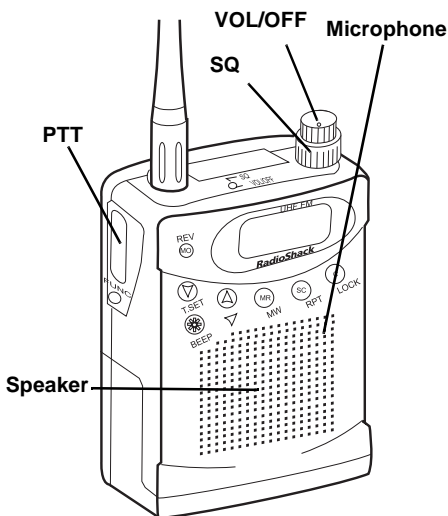





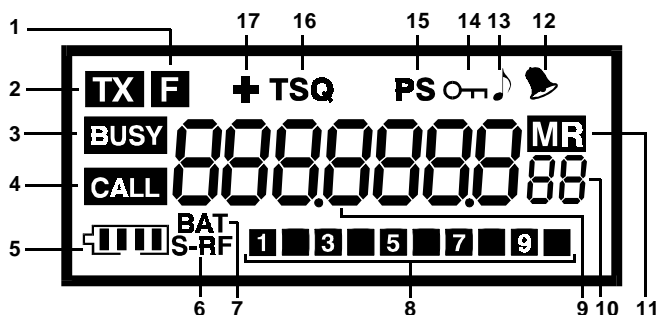

Key/Control	Use it to:	Use with the FUNC + Key to:
<b>VOL/OFF</b>	Turn the radio on/off. Adjust the volume.	Access the Main Menu.
<b>SQ</b>	Set the squelch level to block weak signals.	N/A
<b>▲ (▼)</b>	Change (increase) the frequency by the value set for <b>CS</b> (see the first menu option on Page 16).	Directly changes the frequency, one digit at a time. Repeatedly press ▲ to access each digit of the displayed frequency.

Key/Control	Use it to:	Use with the FUNC + Key to:
▼ (T.SET)	Change (decrease) the frequency by the value set for <b>CS</b> (see the first menu option on Page 16).	Accesses the Tone Set Option menu and settings.
MO (REV)	Press to override squelch. Press and hold to cycle through <b>rC</b> , <b>tC</b> , <b>r</b> , and <b>CS</b> settings.	Reverse the repeater offset.
* (BEEP)	Turn on the display's backlight for 4 seconds.	Enable/disable the key tone.  appears when the key tone is enabled.
MR (MW)	Enter memory setting mode. <b>MR</b> and the last used memory location appear.	In memory mode, starts the display flashing. Then use ▼ or ▲ to access a frequency to store in a memory location.
SC (RPT)	Starts and stops scanning. Hold down and power on to access expanded band coverage (420–450 MHz).	Set the radio to simplex or duplex mode when in VCO mode. Set the repeater offset for a memory location when in memory mode.

Key/Control	Use it to:	Use with the FUNC + Key to:
<b>C (LOCK)</b>	Press once to display and switch to the current call frequency. Hold down to change the call frequency and associated parameters, such as repeater offset and CTCSS tones.	Lock the control (except <b>PTT</b> , <b>MO</b> , <b>*</b> , <b>VOL</b> , and <b>SQ</b> ). Press again to unlock the controls.
<b>PTT</b> (Push To Talk)	Hold down to transmit. Press to store the settings.	Swap the input and output frequencies for repeater operations.

# A QUICK LOOK AT THE DISPLAY



1. **F**: appears when the **FUNC** key is pressed.
2. **TX**: appears when the radio is transmitting.
3. **BUSY**: appears when the radio receives a signal.
4. **CALL**: appears when tone squelch is on and the radio receives a matching tone.
5. : indicates the battery strength.
6. **S-RF** (Signal/RF Indicator): shows the level of an incoming signal. When transmitting, shows the relative output signal strength.
7. **BAT**: appears when you turn on the radio — the signal strength meter then indicates the battery strength.
8. : the stronger the signal, the more boxes appear. Bars show remaining battery power when **MO** and **PTT** switch are held down at the same time.
9. **Alpha-Numeric Display**: shows frequency and messages.
10. **Memory Location**: shows the memory channel in use.
11. **MR** (Memory Channel indicator): for use or for programming.
12. : paging tone active.
13. : key tone enabled.
14. : keypad control disabled to prevent accidentally changing a setting.
15. **PS**: appears when power save is enabled.
16. **TSQ**: appears when Tone Squelch (CTCSS) is enabled.
17. **+**: appears to indicate a positive repeater offset. **-** indicates a negative repeater offset.

# OPERATION

---

## TURNING ON THE HTX-400

To turn on the HTX-400, rotate **VOL/OFF** clockwise until it clicks. The HTX-400 sounds a brief melody if the key tone feature is enabled. Then **HELLO** appears for about 2 seconds and the last used frequency appears.

## SELECTING FREQUENCIES (DIRECT TUNING)

You tune to the desired frequencies in the VFO (variable frequency oscillator) mode. You can either step to a specific frequency or directly select the frequency.

To step to a frequency, repeatedly press or hold down **▲** or **▼** until the display shows the desired frequency.

**Note:** The HTX-400 steps up or down in increments which you set using the Frequency Step menu option. (See “Setting the Frequency Step” on Page 39).

To directly enter a frequency, press **FUNC+▲** (the second digit from the left flashes), then press **▼** or **▲** to change the number. Press **FUNC+▲** again to select the next digit. Repeat this to select each number of the desired frequency, then press **PTT** to store the selection.

**Note:** The HTX-400 is preset to receive frequencies between 420 and 470 MHz, and transmit between 430 and 450 MHz. To expand the frequency coverage, see “Changing the Transmit Frequency Range” on Page 38.

---

---

## RECEIVING TRANSMISSIONS

Follow these steps to receive standard transmissions.

1. With the radio on, rotate **SQ** counterclockwise until you hear a hissing sound. Then slowly rotate **SQ** clockwise just until the noise stops.

### Notes:

- **BUSY** appears when the HTX-400 receives a standard transmission or if the squelch is open. If the transmission uses CTCSS tones, **CALL** also appears.
  - Volume, power, and squelch are combined in one control. The inner control is **VOL** (volume) and power on/off, while the outer control is **SQ** (squelch).
  - If the HTX-400 picks up unwanted, weak transmissions, rotate **SQ** clockwise to prevent the squelch from opening for these transmissions. If you want to hear weak transmissions, rotate **SQ** counterclockwise. When you do this, you might hear hissing between transmissions.
2. Set **VOL/OFF** to a comfortable listening level.

## TEMPORARILY OPENING SQUELCH

If you use the Tone Squelch (CTCSS) feature, you might not hear a transmission on the current frequency. To temporarily open the squelch so you can hear all transmissions on the frequency, hold down **MO**. To resume normal operation, release **MO**.



---

---

## TRANSMITTING

There are two basic types of communication possible with this transceiver: radio-direct-to-radio (simplex) or radio-to-repeater-to-radio (duplex). Simplex operation uses the same frequency to send and receive. Duplex operation uses one frequency to transmit and another to receive. For more information about duplex, see "Understanding Repeaters" on Page 26.

**Caution:** It is illegal to transmit if you do not have at least a Technician Class license issued by the FCC.

Follow these steps to transmit.

1. Select the desired frequency using manual or direct entry.
2. Hold the HTX-400 about 3 inches from your mouth.
3. Hold down **PTT**, then speak slowly and clearly into the microphone. **TX** appears while you transmit.

**Note:** If you try to transmit outside the transmit frequency range, **inhibit** briefly appears.

4. Release **PTT** when you finish transmitting.

# UNDERSTANDING REPEATERS

---

Operation through a repeater, where you transmit on one frequency and receive on another, is called *duplex* operation. Operation direct to another station, where you transmit and receive on the same frequency, is called *simplex* operation.

A repeater is a station that receives a signal on one frequency (the *input* frequency) and then retransmits that signal on a different frequency (the *output* frequency). Repeater antennas are typically located at the tops of tall buildings or on antenna towers, so a relatively low-power signal can reach the repeater. The repeater retransmits the signal at a higher power. This gives your transceiver the ability to communicate over a much greater range.

To use a repeater, you must know the repeater's input and output frequencies. Repeaters are usually identified by their output frequency. Thus, a repeater that has an output frequency of 442.200 is referred to as "the 442.2 repeater." To determine the input frequency, you must know the frequency *offset* (typically 5 MHz for the 70 cm-meter band) and the *offset direction* (+ if you add 5 MHz to the output, or – if you subtract 5 MHz from the output).

Whether the offset is positive or negative depends on:

- which part of the band the repeater operates on
- local convention
- proximity of repeaters using the same two frequencies

To determine the offset and the direction, obtain a copy of *The ARRL Repeater Handbook* (available from your local RadioShack store or directly from the ARRL) which lists the locations of repeaters as well as their frequency and offset information.

A + above the displayed frequency indicates a positive offset, while a – above the frequency indicates a negative offset. If neither + nor – appears, the HTX-400 is set for simplex operation.

---

---

## SETTING THE REPEATER OFFSET FREQUENCY

The HTX-400's default repeater offset is 5 MHz, which appears as 5.00 (MHz). Follow these steps to change the offset.

**Note:** This setting only affects the VFO mode. If you saved a frequency offset in a memory, that setting is not affected.

1. With power off, hold down **FUNC** and turn on the HTX-400,
2. Hold down **FUNC** and repeatedly press  $\blacktriangledown$  until  $r$  and the current offset appear. 5.00 appears if no offset is currently set.

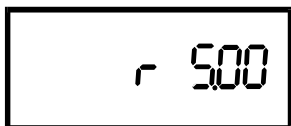

3. Repeatedly press  $\blacktriangledown$  or  $\blacktriangle$  until the desired offset appears. You can set an offset between 0 and 8 MHz in 50kHz steps.
4. Press **PTT** to store the setting and exit the menu.

## TURNING DUPLEX OPERATION ON AND OFF

To turn on duplex (repeater use) operation for the VFO mode, press **FUNC + SC (RPT)**. Provided the current repeater offset value is not 0.00, the current offset indicator (+ above or - below) appears above the displayed frequency. Press **FUNC + SC (RPT)** again to turn it off.

---

---

## SETTING THE REPEATER OFFSET DIRECTION

1. Set an offset frequency other than 0.00.
2. Press **FUNC + SC (RPT)** to see the current offset direction (+ above or – below).
3. Press **FUNC + MO (REV)** to change the repeater offset direction.

**Note:** To save this setting in a memory location, **MR** must be flashing before you store the settings (see “Using the Calling-Frequency Memory” on Page 31 and “Storing a Transmit/Receive Frequency” on Page 29). Otherwise, the setting reverts to its saved value the next time you turn on the HTX-400.

## REVERSING THE TRANSMIT AND RECEIVE FREQUENCIES

To swap the input and output frequencies, press **FUNC+PTT**. For example, if you have set the radio to repeater operation on 442.200 with a positive offset of 5 MHz, the radio would normally receive on 442.200 and transmit on 447.200 MHz. After you press **FUNC+PTT**, the radio will receive on 447.200 and transmit on 442.200.

This feature is useful if you want to determine whether you are close enough to another station to communicate on a simplex frequency. While the other station is transmitting, reverse the frequencies. If you can still hear the other station, you are hearing their signal directly and you do not need to use the repeater.

# MEMORY OPERATION

---

Your HTX-400 has 30 standard memory locations that you can use to store frequencies for quick access. For each memory location, you can also store other settings such as the repeater offset, CTCSS tones, and frequencies to pass or lock out during scanning.

## STORING A TRANSMIT/RECEIVE FREQUENCY

1. Press **MR**. **MR** and the last used memory location appear.
2. Repeatedly press **▲** or **▼** to select the desired memory location. ----- appears if the memory location is empty.
3. Press **FUNC+MR**. The selected memory location and **MR** flash.
4. Select the desired frequency by repeatedly pressing **▲** or **▼**, or use direct frequency entry to select a frequency.
5. To enter a frequency offset for repeater operation, press **FUNC + SC**. The HTX-400 displays the current offset for the calling frequency. Then press **▲** or **▼** to select the desired offset. Press **PTT** to store your setting.
6. Press **FUNC + REV** to select the offset direction (+ or -). To remove an offset for simplex operation, set the repeater offset to **0 . 00**.
7. If desired, set the tone squelch settings (see "Continuous Tone Coded Squelch System Features" on Page 35).
8. Press **PTT** to store all settings, then press **MR** to exit the memory mode.

---

---

## RECALLING MEMORIES

To recall saved memory settings, press **MR** so **MR** appears. Then press **▲** or **▼** to select the desired memory location.

Press **MR** again to return to the VFO mode, (See “Selecting Frequencies (Direct Tuning)” on Page 23.)

## CLEARING A SINGLE MEMORY

Follow these steps to clear any single memory location.

1. Press **MR** . **MR** and the last used memory location appear.
2. Repeatedly press **▲** or **▼** to select the desired memory location.
3. Press **FUNC+MR**. The selected memory location and **MR** flash.
4. Hold down **FUNC** for several seconds. The memory location clears and ----- appears to confirm that the location is empty.
5. Press **MR** to exit the memory mode.

**Note:** To clear all memory locations, see “Resetting the HTX-400” on Page 44.

---

---

## USING THE CALLING-FREQUENCY MEMORY

The calling-frequency memory location lets you quickly jump to a specific frequency at any time. The default calling frequency is 446.0000 MHz. You can store a different frequency into memory as well as other settings associated with that frequency, such as the repeater offset and CTCSS tone.

1. Press **C** to display the current calling frequency.
2. To change the frequency, hold down **C** until **MR** and **C** flash.
3. Select a frequency. See “Selecting Frequencies (Direct Tuning)” on Page 23.
4. Press **C** to store the selected frequency in memory.
5. To enter a frequency offset for repeater operation, press **FUNC+SC**. The HTX-400 displays the current offset for the calling frequency. To select a new offset value, press **▲** or **▼**. Select 0.00 Hz if you want to remove the offset. To store the setting, press **PTT**.
6. To select the offset direction (+ or -), press **FUNC + REV**. To remove an offset for simplex operation, set the repeater offset to **0 . 00**.

**Note:** While **MR** and **C** appear, you can program other settings such as CTCSS tones (see “Continuous Tone Coded Squelch System Features” on Page 35.)

To enable the calling frequency, press **C** at any time. The transceiver immediately tunes to that frequency with the settings you programmed. To exit the calling frequency mode, press **C** again.

# SCANNING OPERATION

---

## SCANNING FOR ACTIVE FREQUENCIES

1. To search for activity on a frequency, press **SC**. The transceiver begins to scan up or down the full frequency range, and it stops on each active frequency for the duration set by the scan delay option (see “Using Scan Delay” on Page 32).
2. To change the scanning direction, press **▲** or **▼**.
3. To stop on a frequency or to stop scanning completely, press **SC** again.

### Using Scan Delay

If the HTX-400 stops on a signal during scanning, then *that signal* stops, the scan delay feature delays the continuation of scanning to allow time for the signal to restart. Access the Main Menu (see “Using the HTX-400’s Menu” on Page 16) to set the value. With **Sd** and the current delay time shown, press **▲** or **▼** to select the new delay time (between 1 and 30 seconds).

## SCANNING STANDARD MEMORY LOCATIONS

1. Press **MR** (so **MR** appears), then press **SC**. The transceiver scans all locations except empty locations and the ones you programmed to be passed during scanning.
2. To change the scanning direction, press **▲** or **▼**.
3. To stop scanning, press **SC** again.



---

---

## Setting A Memory Location to Always Skip During Scanning

The HTX-400 is preset to include all memory locations (except empty locations) during memory scanning. Follow these steps to set the transceiver to have it always skip (or resume scanning) a specific location during scanning.

1. Press **MR**. **MR** and the last used memory location appear.



2. Repeatedly press **▲** or **▼** to select the desired memory location.
3. Press **FUNC+MR**. The selected memory location and **MR** flash.
4. To set the HTX-400 to skip the memory location, press **SC**, then press **▼** or **▲** so **SCSP ON** (scan skip) appears.

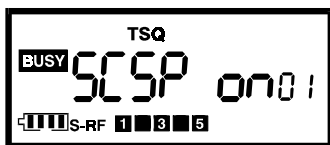

To include the displayed location during scanning, press **▼** or **▲** so **SCSP OF** appears.

5. When you finish, press **SC** again, then press **PTT** to store the setting.

---

---

## Temporarily Locking Out (Skipping) Locations During Memory Scanning

You can set the transceiver to lock out a location while scanning the frequencies stored in memory.

When the transceiver stops at a memory location you want to skip, press **FUNC**. **PASS** briefly appears and the transceiver continues to scan, locking out (skipping) that location from then on. Repeat this for each location you want to skip.



To cancel the settings and have the HTX-400 include the skipped frequencies once again, turn the radio off then on again.

**Note:** You cannot lock out all memory locations. One location is always active. If you lock out all but two active locations and then lock out one more, **EMPTY** briefly appears and scanning stops.

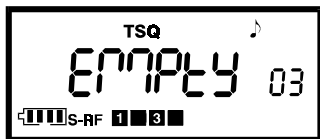

# CONTINUOUS TONE CODED SQUELCH SYSTEM FEATURES

Your HTX-400 can transmit and receive a low-level, selectable subaudible tone at the same time as it transmits (TX) or receives (RX) a regular signal. This special tone lets you listen only to other radios set to the same tone frequency when you use the HTX-400 in simplex operation. It also lets you match your radio to the subaudible tone frequency used by a local repeater.

To enable the TX and RX tones for the HTX-400, follow these steps.

1. Press **FUNC+▼**. The current tone setting appears (**tONE oF** or **tone on**).
2. Press **▼** or **▲** to turn on the option. **tONE on** appears.



3. To set a receive (RX) tone, press **FUNC+▼**. **rC** appears. Then press **▼** or **▲** to select a tone frequency from the list on Page 36. For this example, 67.0 Hz was selected for both the transmit and receive frequencies.

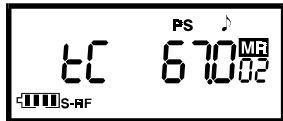
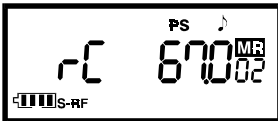

4. To set a transmit (TX) tone, press **FUNC+▼**. **tC** appears. Then press **▼** or **▲** to select a tone frequency from the list on Page 36.
5. Press **PTT** to store all the settings.

---

---

To select and store a CTCSS subaudible tone in a memory location, press **MR**. **MR** and the last used memory location appear. (In the examples shown on the preceding page, memory location 2 is used.) Then follow the preceding Steps 1–5.

### Subaudible Tone Frequencies (Hz)

67.0	114.8	186.2
69.3	118.8	189.9
71.9	123.0	192.8
74.4	127.3	196.6
77.0	131.8	199.5
79.7	136.5	203.5
82.5	141.3	206.5
85.4	146.2	210.7
88.5	151.4	218.1
91.5	156.7	225.7
94.8	159.8	229.1
97.4	162.2	233.6
100.0	167.9	241.8
103.5	173.8	250.3
107.2	179.9	254.1
110.9	183.5	Off

---

---

## TONE PAGING

You can set the HTX-400 to sound an alert tone when it receives a transmission that includes the currently set subaudible receive-tone (or any transmission, if the receive-tone or the tone feature is set to off). Turn off the radio, then press \* while you turn the HTX-400 on again.  appears.

The first time the HTX-400 receives a transmission that matches the current CTCSS settings, it sounds the selected alert tone, then turns off the tone paging feature. To turn the feature back on, turn the power off then on again while holding down \*.

Follow these steps to change the alert tone.

1. Select the VFO mode. (See “Selecting Frequencies (Direct Tuning)” on Page 23.)
2. Hold down **FUNC** and press **▼ (T.SET)** four times. **MEL** and a number from **1** to **5** appear. Release **FUNC**.



3. Repeatedly press either **▼** or **▲** to step through the five different tones. If key tone is enabled, each tone sounds as you select its number.
4. Press **PTT** to store your selection and exit the menu.

## SENDING PAGING TONES

To transmit the selected paging tone, press \* while pressing **PTT**.

## OTHER SPECIAL FEATURES

---

### CHANGING THE TRANSMIT FREQUENCY RANGE

You can change the standard transmit frequency range from 430–450 MHz to an extended range of 420–450 MHz.

To set the transceiver to its extended range, turn off the transceiver, then hold down **SC** and turn on the transceiver again.

To return to the standard frequency range, turn off the transceiver, then hold down **SC** and turn it on again.

### LOCKING THE KEYPAD

To lock the transceiver's keypad so you do not accidentally change a setting, press **FUNC+LOCK**.  appears. This locks all buttons except **PTT**, **\***, **VOL**, and **SQ**.

To unlock the keypad, press **FUNC + LOCK** again.

### LIGHTING THE DISPLAY

Press **\*** to turn on the display's backlight for about 4 seconds. If you press any key while the light is on, the light remains on for about 4 seconds more. Hold down **\*** for at least 1 second to have the light remain on until you press **\*** again.

---

---

## TURNING THE KEY TONE ON AND OFF

The transceiver is preset to sound a beep each time you press a key. To turn off the beep, press **FUNC+\*** (**BEEP**). **!** disappears. To restore the key tone, press **FUNC + \*** (**BEEP**) again.

**Note:** If the key tone feature is disabled, the power-on tone does not sound.

## CHECKING THE CURRENT MEMORY SETTINGS

If you hold down **MO (REV)** for longer than 1 second, the squelch opens and the set values for receive tone (**rT on/off**), transmit tone (**tt on/off**), scan skip condition (**SCSP**)(if any), repeater offset (**r**), and frequency step (**CS**) appear.

Release **MO (REV)** to turn on the squelch again.

## SETTING THE FREQUENCY STEP

To change the frequency increment used during scanning and stepping to a frequency, use the Main Menu to access the **CS** option setting (see "Using the HTX-400's Menus" on Page 16). Then repeatedly press **▲** or **▼** until you reach the desired setting. You can change the frequency step to 5 kHz, 10 kHz, 12.5 kHz, 15 kHz, 20 kHz, 25 kHz, 50 kHz, or 1 MHz. (The example shown here is 25 kHz.)

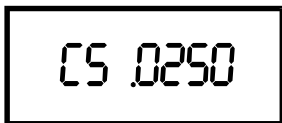

---

---

## POWER SAVE

The power save feature lets the radio conserve battery power by turning off power to the receiver section and periodically turning it on to check for a transmission. Use the Main Menu to set the power save option (see “Using the HTX-400’s Menu” on Page 16). With **PS** and the current status (**on** or **OFF**) displayed, press ▲ or ▼ to turn this feature on or off.

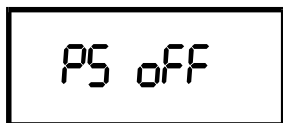

## TIME-OUT TIMER

When you communicate using repeaters, keep your transmissions as brief as possible. Most repeaters have built-in timers that limit single transmissions to 3 minutes or less. You can set the transceiver to stop transmitting and sound a beep if you exceed a set time limit with a single transmission.

Use the Main Menu (see “Using the HTX-400’s Menu” on Page 16) to set a value for the time-out timer. With **tot** and the current setting displayed, press ▲ or ▼ to choose a value from 0 to 990 seconds.

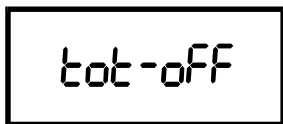



---

---

## REDUCING SQUELCH TAIL

If you are communicating with a repeater or another station using subaudible tones, you can eliminate the squelch tail (the burst of noise the other person hears when you stop transmitting) by turning on the transmit delay option. When you turn on this feature and use CTCSS, the radio continues to transmit for a short period of time after you release **PTT**, but then it immediately drops the subaudible tone. This causes the other radio to close the squelch before there is “dead air,” preventing the squelch tail.

Use the Main Menu (see “Using the HTX-400’s Menu” on Page 16) to set the transmit delay option, . Then, with **t.dy** and the current status displayed, press **▲** or **▼** to turn this feature on or off.

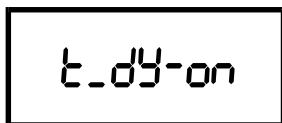

## BUSY CHANNEL LOCKOUT

Use the Main Menu to set the busy channel lockout (see “Using the HTX-400’s Menu” on Page 16). The lockout prevents the transceiver from transmitting while it is receiving a signal. With the radio’s preset value **bCLO oF** displayed, press **▲** or **▼** to change the display to **bCLO oN**. Repeat this step to change the display back to **bCLO oF** to disable the lockout .



# TROUBLESHOOTING

---

If your transceiver is not working as it should and it displays an error message, these suggestions might help you eliminate the problem. If the transceiver still does not operate properly, take it to your local RadioShack store for assistance.

<b>You see</b>	<b>Possible Cause</b>	<b>Remedies</b>
<b>S-SHORT</b>	If the transceiver detects a shorted external microphone connection, it automatically switches off power to the audio amplifier and displays <b>S-SHORT</b> to indicate a short circuit.	Remove the connected microphone and replace it, or use the internal microphone.
<b>PLL-Error</b>	Indicates a PLL circuit malfunction due to a defect in the VCO circuit or bias supply.	Turn power off then on again.
<b>EEP-Error</b>	The EPROM information needs to be reset.	Reset the transceiver. See "Resetting the HTX-400" on Page 44.

# CARE AND MAINTENANCE

---

Your RadioShack HTX-400 Mini Handheld 70-Centimeter FM Amateur Transceiver is an example of superior design and craftsmanship. The following suggestions will help you care for your transceiver so you can enjoy it for years.



Keep the transceiver dry. If it gets wet, wipe it dry immediately. Liquids might contain minerals that can corrode the electronic circuits.



Use and store the transceiver only in normal temperature environments. Temperature extremes can shorten the life of electronic devices, damage batteries, and distort or melt plastic parts.



Keep the transceiver away from dust and dirt, which can cause premature wear of parts.



Handle the transceiver gently and carefully. Dropping it can damage circuit boards and cases and can cause the transceiver to work improperly.



Use only fresh batteries of the required size and recommended type. Batteries can leak chemicals that damage your transceiver's electronic parts.



Wipe the transceiver with a damp cloth occasionally to keep it looking new. Do not use harsh chemicals, cleaning solvents, or strong detergents to clean the transceiver.

Modifying or tampering with the transceiver's internal components can cause a malfunction and might invalidate its warranty and void your FCC authorization to operate it. If your transceiver is not performing as it should, take it to your local RadioShack store for assistance.

---

---

## USING THE KEYPAD DIAGNOSTIC

The HTX-400 has a built-in diagnostic program that lets you confirm whether the keypad switches are functioning correctly. To use this diagnostic program, follow these steps.

1. Hold down **MO (REV)** and turn on the transceiver.
2. Press **MO (REV)** again. **PrESS dn** appears.
3. Press **▼**. If the action is correct, **PrESS Up** appears.
4. Press **▲**. If the action is correct, **PrES Mr** appears.
5. Press **MR (MW)**. If the action is correct, **PrESS Sc** appears.
6. Press **SC (RPT)**. If the action is correct, **PrESS bp** appears.
7. Press **\* (BEEP)**. If the action is correct, **PrESS Lc** appears.
8. Press **LOCK (C)**. If the action is correct, **F** appears.
9. Press **FUNC**. If the action is correct, **PrES Mo** appears.
10. Press **MO (REV)**. If this action is correct, **GOOD** appears briefly and then the set frequency appears again.

## RESETTING THE HTX-400

If the transceiver's display locks up or the transceiver does not work properly after you turn it on, you might need to reset it.

**Caution:** This procedure clears all the information you have programmed into the transceiver. Before you reset the transceiver, try turning it off then on again to see if it begins working properly.

To reset the transceiver, turn it off then hold down **FUNC +MO** and turn it on again. **initial** appears to confirm the reset operation. Release **FUNC+MO**.

# SPECIFICATIONS

---

## GENERAL

Frequency:	
RX .....	420–470 MHz
TX .....	430–450 MHz
Extended TX Range .....	420–450 MHz
Frequency Generation .....	PLL Synthesizer
Frequency Stability .....	± 5 ppm
Operating Temperature .....	14° to 131°F (–10° to 55°C)
Power Source .....	DC 3.0V to 9V
Modulation .....	F3E
Impedance .....	50 ohm
Dimensions (HWD) .....	2 <sup>1</sup> / <sub>4</sub> × 3 <sup>3</sup> / <sub>8</sub> × 1 <sup>1</sup> / <sub>16</sub> inches
	85 × 58 × 26.5 mm
Weight (without batteries) .....	4.2 oz (120 g)

## RECEIVER

Circuit Type .....	Dual Conversion, Superheterodyne
IF Frequency:	
1st IF .....	30.85 MHz
2nd IF .....	450 kHz
Sensitivity .....	0.22 µV for 12 dB SND
Selectivity .....	50 dB Min.
Spurious and Image Rejection .....	60 dB Min.
Intermodulation .....	60 dB Min.
Distortion .....	10% Max.
S/N Ratio .....	35 dB Min.
Audio Output @10%THD .....	90 mW 16 Ohm, BTL

## TRANSMITTER

Power Output .....	200 mW, DC 3.0V/1W, DC 9.0V
Distortion .....	5%
Deviation .....	± 5 kHz
S/N Ratio .....	36 dB
Current Drain .....	600 mA, DC 3V/900mA DC 9V

Specifications are typical; individual units might vary. Specifications are subject to change and improvement without notice.

# NOTES

---

---



## Limited One-Year Warranty

This product is warranted by RadioShack against manufacturing defects in material and workmanship under normal use for one (1) year from the date of purchase from RadioShack company-owned stores and authorized RadioShack franchisees and dealers. EXCEPT AS PROVIDED HEREIN, RadioShack MAKES NO EXPRESS WARRANTIES AND ANY IMPLIED WARRANTIES, INCLUDING THOSE OF MERCHANTABILITY AND FITNESS FOR A PARTICULAR PURPOSE, ARE LIMITED IN DURATION TO THE DURATION OF THE WRITTEN LIMITED WARRANTIES CONTAINED HEREIN. EXCEPT AS PROVIDED HEREIN, RadioShack SHALL HAVE NO LIABILITY OR RESPONSIBILITY TO CUSTOMER OR ANY OTHER PERSON OR ENTITY WITH RESPECT TO ANY LIABILITY, LOSS OR DAMAGE CAUSED DIRECTLY OR INDIRECTLY BY USE OR PERFORMANCE OF THE PRODUCT OR ARISING OUT OF ANY BREACH OF THIS WARRANTY, INCLUDING, BUT NOT LIMITED TO, ANY DAMAGES RESULTING FROM INCONVENIENCE, LOSS OF TIME, DATA, PROPERTY, REVENUE, OR PROFIT OR ANY INDIRECT, SPECIAL, INCIDENTAL, OR CONSEQUENTIAL DAMAGES, EVEN IF RadioShack HAS BEEN ADVISED OF THE POSSIBILITY OF SUCH DAMAGES.

Some states do not allow the limitations on how long an implied warranty lasts or the exclusion of incidental or consequential damages, so the above limitations or exclusions may not apply to you.

In the event of a product defect during the warranty period, take the product and the RadioShack sales receipt as proof of purchase date to any RadioShack store. RadioShack will, at its option, unless otherwise provided by law: (a) correct the defect by product repair without charge for parts and labor; (b) replace the product with one of the same or similar design; or (c) refund the purchase price. All replaced parts and products, and products on which a refund is made, become the property of RadioShack. New or reconditioned parts and products may be used in the performance of warranty service. Repaired or replaced parts and products are warranted for the remainder of the original warranty period. You will be charged for repair or replacement of the product made after the expiration of the warranty period.

This warranty does not cover: (a) damage or failure caused by or attributable to acts of God, abuse, accident, misuse, improper or abnormal usage, failure to follow instructions, improper installation or maintenance, alteration, lighting or other incidence of excess voltage or current; (b) any repairs other than those provided by a RadioShack Authorized Service Facility; (c) consumables such as fuses or batteries; (d) cosmetic damage; (e) transportation, shipping or insurance costs; or (f) costs of product removal, installation, set-up service adjustment or reinstallation.

This warranty gives you specific legal rights, and you may also have other rights which vary from state to state.

RadioShack Customer Relations, 200 Taylor Street, 6th Floor,  
Fort Worth, TX 76102

*We Service What We Sell*

04/99



## Free Manuals Download Website

<http://myh66.com>

<http://usermanuals.us>

<http://www.somanuals.com>

<http://www.4manuals.cc>

<http://www.manual-lib.com>

<http://www.404manual.com>

<http://www.luxmanual.com>

<http://aubethermostatmanual.com>

Golf course search by state

<http://golfingnear.com>

Email search by domain

<http://emailbydomain.com>

Auto manuals search

<http://auto.somanuals.com>

TV manuals search

<http://tv.somanuals.com>