

ULTRABASS PRO EX1200

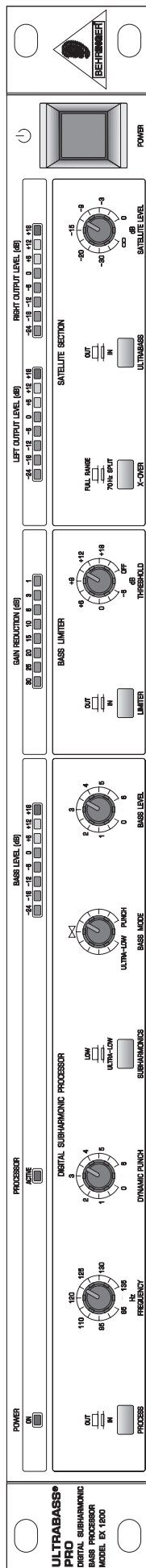

User's Manual

Version 1.1 April 2001

ENGLISH



www.behringer.com

SAFETY INSTRUCTIONS

CAUTION: To reduce the risk of electric shock, do not remove the cover (or back). No user serviceable parts inside; refer servicing to qualified personnel.



WARNING: To reduce the risk of fire or electric shock, do not expose this appliance to rain or moisture.



This symbol, wherever it appears, alerts you to the presence of uninsulated dangerous voltage inside the enclosure—voltage that may be sufficient to constitute a risk of shock.



This symbol, wherever it appears, alerts you to important operating and maintenance instructions in the accompanying literature. Read the manual.

DETAILED SAFETY INSTRUCTIONS:

All the safety and operation instructions should be read before the appliance is operated.

Retain Instructions:

The safety and operating instructions should be retained for future reference.

Heed Warnings:

All warnings on the appliance and in the operating instructions should be adhered to.

Follow instructions:

All operation and user instructions should be followed.

Water and Moisture:

The appliance should not be used near water (e.g. near a bathtub, washbowl, kitchen sink, laundry tub, in a wet basement, or near a swimming pool etc.).

Ventilation:

The appliance should be situated so that its location or position does not interfere with its proper ventilation. For example, the appliance should not be situated on a bed, sofa, rug, or similar surface that may block the ventilation openings, or placed in a built-in installation, such as a bookcase or cabinet that may impede the flow of air through the ventilation openings.

Heat:

The appliance should be situated away from heat sources such as radiators, heat registers, stoves, or other appliances (including amplifiers) that produce heat.

Power Source:

The appliance should be connected to a power supply only of the type described in the operating instructions or as marked on the appliance.

Grounding or Polarization:

Precautions should be taken so that the grounding or polarization means of an appliance is not defeated.

Power-Cord Protection:

Power supply cords should be routed so that they are not likely to be walked on or pinched by items placed upon or against them, paying particular attention to cords and plugs, convenience receptacles and the point where they exit from the appliance.

Cleaning:

The appliance should be cleaned only as recommended by the manufacturer.

Non-use Periods:

The power cord of the appliance should be unplugged from the outlet when left unused for a long period of time.

Debris and Liquid Entry:

Care should be taken that debris and/or liquids do not enter the enclosure through openings.

Damage Requiring Service:

The appliance should be serviced by qualified service personnel when:

- The power supply cord or the plug has been damaged; or
- Debris or liquid has entered the appliance; or
- The appliance has been exposed to rain; or
- The appliance does not appear to operate normally or exhibits a marked change in performance; or
- The appliance has been dropped, or the enclosure damaged.

Servicing:

The user should not attempt to service the appliance beyond that which is described in the operating instructions. All other servicing should be referred to qualified service personnel.

FOREWORD

Dear Customer,

Welcome to the team of ULTRABASS PRO users and thank you very much for expressing your confidence in BEHRINGER products by purchasing the EX1200.

It is one of my most pleasant tasks to write this letter to you, because it is the culmination of many months of hard work delivered by our engineering team to reach a very ambitious goal: making an outstanding device that will become a standard tool used by studios and PA companies. The task to design the ULTRABASS PRO certainly meant a great deal of responsibility, which we assumed by focusing on you, the discerning user and musician. It also meant a lot of work and night shifts to accomplish this goal. But it was fun, too. Developing a product usually brings a lot of people together, and it's a great feeling, when everybody who participated in such a project can be proud of what we've achieved.

It is our philosophy to share our joy with you, because you are the most important member of the BEHRINGER family. With your highly competent suggestions for new products you've greatly contributed to shaping our company and making it successful. In return, we guarantee you uncompromising quality (manufactured under ISO9000 certified management system) as well as excellent technical and audio properties at an extremely favorable price. All of this will enable you to fully unfold your creativity without being hampered by budget constraints.

We are often asked how we can make it possible to produce such high-grade devices at such unbelievably low prices. The answer is quite simple: it's you, our customers! Many satisfied customers mean large sales volumes, enabling us to get better conditions of purchase for components. Isn't it only fair to pass this benefit back to you? Because we know that your success is our success too!

I would like to thank all people whose help on "Project ULTRABASS PRO" has made it all possible. Everybody has made very personal contributions, starting from the designers of the unit via the many staff members in our company to you, the user of BEHRINGER products.

My friends, it's been worth the trouble!

Thank you very much,

A handwritten signature in black ink, appearing to read 'U. Behringer', with a long horizontal stroke extending to the right.

Uli Behringer

ULTRABASS PRO

Professional, multi purpose Bass Sound Enhancement system for stage and studio applications

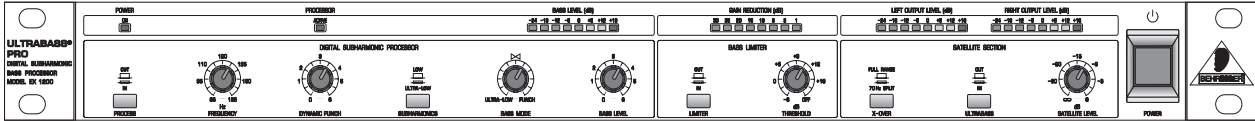

- ▲ Digital subharmonic synthesizer adds unbelievable bass power to your sound system
- ▲ Perfect for discotheques, dance clubs, cinemas, theatres, sport & aerobic studios and your Hi-Fi system
- ▲ Digital synthesis based on waveform analysis generates ultra-low frequencies for driving subwoofers
- ▲ Releases untapped sonic resources and adds power to instruments, vocals and mixed program material
- ▲ Waveform processor musically restores low frequencies normally lost in the recording process
- ▲ Built-in limiter protects against low-frequency speaker over-excursion
- ▲ Dynamic punch control adds breathtaking kick bass to your program material
- ▲ Bass mode control allows you to fade over from “ultra-low” to “punchy” bass sounds
- ▲ Subharmonics function allows you to choose between low and ultra-low subharmonics
- ▲ Separate subwoofer output to connect a separate subwoofer system
- ▲ Incorporates a switchable x-over to split off dangerous low frequencies from your club system
- ▲ Precision output level and gain reduction LED displays provide clear visual indication of operation
- ▲ Servo-balanced gold-plated XLR and 1/4" TRS inputs and outputs
- ▲ Ultra low-noise 4580 audio operational amplifiers for outstanding sound performance
- ▲ High-quality detented potentiometers and illuminated switches
- ▲ Manufactured under ISO9000 certified management system

TABLE OF CONTENTS

1. INTRODUCTION	6
1.1 The Design Concept	6
1.2 Before You Begin	6
1.3 Control Elements	8
1.3.1 Front Panel	8
1.3.2 Rear Panel	10
2. APPLICATIONS	10
2.1 Systems without Subwoofer	10
2.2 Systems with Subwoofer	11
2.3 Multiway Active System	12
2.4 The ULTRABASS PRO in a Hi-Fi System	12
3. TECHNICAL BACKGROUND	13
3.1 The Integrated Frequency Crossover	13
3.2 The Integrated Limiter	13
4. INSTALLATION	14
4.1 Audio Connections	14
5. SPECIFICATIONS	15
6. WARRANTY	16

1. INTRODUCTION

Thank you very much for expressing your confidence in BEHRINGER products by purchasing the ULTRABASS PRO EX1200. The BEHRINGER ULTRABASS PRO is a completely new subharmonic synthesizer based on digital technology for the generation and processing of low frequencies.

 **This manual first describes the terminology used, so that you can fully understand the ULTRABASS PRO and its functions. Please read the manual carefully and keep it for future reference.**

1.1 The Design Concept

Why is there a need for a subharmonic synthesizer?

In many recordings, the low-frequency spectrum has been filtered deliberately or gets lost somewhere in the transmission chain. In most cases, the recording medium is characterized by a limited dynamic range and frequency response. Reproduction quality may also be adversely affected by a low-performance speaker system. Thus, tape material, records and broadcast transmissions for example soon reach their limits, in terms of frequency and amplitude range. Vital bass frequencies are therefore not reproduced. Very often, the low frequencies are filtered deliberately to facilitate reproduction via small loudspeakers found in portable radios, car systems etc. The recording lacks the essential bass emphasis and the resulting sonic image lacks power.

More bass power with the BEHRINGER ULTRABASS PRO

In contrast to simple bass boosting, the ULTRABASS PRO generates additional subharmonics, i.e., musically relevant frequencies one or two octaves below the lowest frequency in the signal. This expands the frequency spectrum both naturally and musically. Contrary to conventional designs, the ULTRABASS PRO is not a so-called “bass booster” simply raising the lower frequency band in level, but uses completely new circuits based on digital technology which filter specific bass frequencies from the program material and feed them to the subharmonic synthesizer. With the aid of digital frequency shifting, the circuitry produces a new frequency spectrum that is enlarged towards the bass end, with the signal shape of the generated low-range frequencies being accurately synthesized on the original wave form. The result is a “dry” and exactly defined low-frequency emphasis, without any “booming” or other disturbing side effects.

Protect your system with the integrated limiter

Bass frequencies provide the highest energy yield within the entire frequency spectrum. When reproducing composite signals, both the power amplifiers and the loudspeakers are under extreme duress. Since conventional bass frequency boosters do not compensate for this, the system is often overloaded with disastrous results.

The ULTRABASS PRO incorporates the highly respected BEHRINGER limiter, which prevents clipping of the generated bass signal in the subsequent system and thus protects it against overloading and damage. You can perfectly limit the levels of bass generated by the EX1200 and the resulting maximum displacement of the loudspeaker diaphragm, to fit the size and power rating of the system.

All-purpose application with the integrated crossover

The ULTRABASS PRO features two operational modes: in FULL RANGE mode the newly generated bass frequencies are added to the original signal and are reproduced by the standard system. In 70 Hz SPLIT mode, however, all frequencies below 70 Hz are removed, which clearly reduces the stress put on the system. The actual bass frequencies are routed via the separate subwoofer output to a special low-range loudspeaker/ amplifier setup.

Turn your system into a “power station”

It is unbelievable how the ULTRABASS PRO adds power to your system. Whether it is the audio system in discotheques and dance clubs, cinemas, theatres, PA systems, broadcast and TV stations, aerobic and sports studios or simply your home stereo system, the ULTRABASS PRO will give you a new audio experience. We are sure that you will enjoy your new BEHRINGER ULTRABASS PRO!

1.2 Before You Begin

Your BEHRINGER ULTRABASS PRO was carefully packed in the factory and the packaging is designed to protect the unit from rough handling. Nevertheless, we recommend that you carefully examine the packaging and its contents for any signs of physical damage, which may have occurred during transit.

☞ If the unit is damaged, please do not return it to BEHRINGER, but notify your dealer and the shipping company immediately, otherwise claims for damage or replacement may not be granted. Shipping claims must be made by the consignee.

The BEHRINGER ULTRABASS PRO fits into one standard 19" rack unit of space. Please allow at least an additional 4" depth for the connectors on the back panel.

Be sure that there is enough space around the unit for cooling and please do not place the ULTRABASS PRO on high temperature devices such as power amplifiers etc. to avoid overheating.

☞ Before you connect your ULTRABASS PRO to the mains, please make sure that your local voltage matches the voltage required by the unit!

The fuse holder on the female mains connector has 3 triangular markers, with two of these triangles opposing each other. Your ULTRABASS PRO is set to the operating voltage printed next to these markers, and can be set to another voltage by turning the fuse holder by 180°. **CAUTION: this instruction does not apply to export models exclusively designed, e.g. for 115 V operation!**

The mains connection of the ULTRABASS PRO is made by using the enclosed mains cable and a standard IEC receptacle. It meets all of the international safety certification requirements.

☞ Please make sure that all units have a proper ground connection. For your own safety, never remove or disable the ground conductor of the unit or of the AC power cable.

As standard, the BEHRINGER ULTRABASS PRO is installed with electronically servo-balanced inputs and outputs. The circuit design features automatic hum rejection for balanced signals, permitting trouble-free operation even at the highest operating levels. Externally induced power-line hum, etc. is thus suppressed effectively. The automatic servo function recognizes the presence of unbalanced connectors and adjusts the nominal level internally to avoid level differences between the input and output signals (6 dB correction).

You will find additional information in chapter 4 "INSTALLATION".

1.3 Control Elements

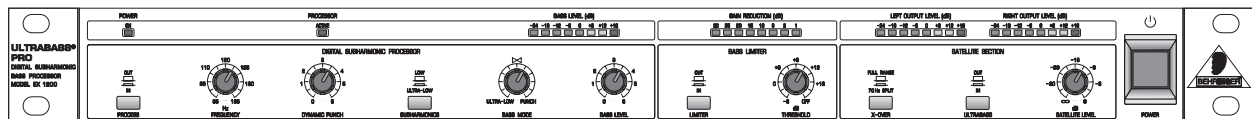

Fig. 1.1: The ULTRABASS PRO

The BEHRINGER ULTRABASS PRO provides 5 illuminated push-button switches, 6 rotary controls, and 4 level displays. The ULTRABASS PRO is designed as a stereo processor and is therefore not suited to process two different signals. The front of the ULTRABASS PRO is divided in three sections, each with its own function.

1.3.1 Front Panel

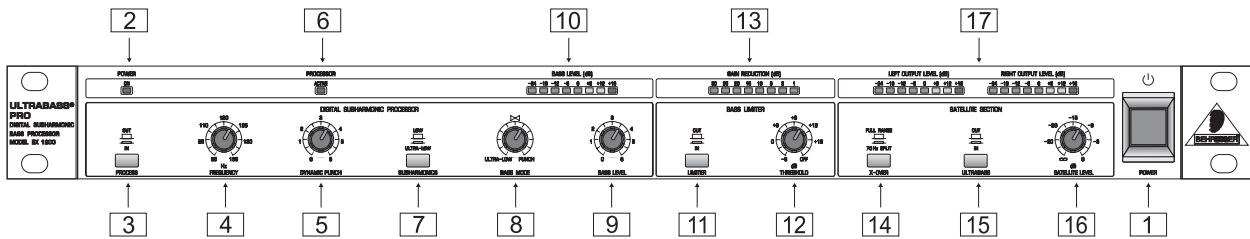



Fig. 1.2: ULTRABASS PRO front panel

- 1 POWER switch. This switch puts the ULTRABASS PRO into operation.

Digital Subharmonic Processor Section

- 2 POWER LED. This LED lights up to indicate that the unit is connected to a mains outlet and that the unit is switched on.
- 3 With the PROCESS switch the signal to the subharmonics generator is switched on or off. If set to OUT, the unit is in bypass mode. The crossover remains active but no harmonics are added to the signal i.e., the bass effect signal is neither sent to the main outputs nor to the subwoofer.
-  The X-OVER function and the SATELLITE LEVEL control are still active in bypass mode (PROCESS OFF).
- 4 FREQUENCY control. This control governs the highest frequency which is sent to the digital harmonics processor. It thus affects the frequency range in which the ULTRABASS PRO works. This is one of the main controls to influence the sound of the unit.
- 5 The DYNAMIC PUNCH control sets the threshold for the digital frequency shifter of the ULTRABASS PRO. Signals below the threshold are not processed. With this control it is possible to prevent the processing of rumble which is not part of the music signal. It is also possible to add depth and punch just to the bass drum for instance.
- 6 ACTIVE LED. This LED lights up as soon as subharmonics are being generated. This depends on the DYNAMIC PUNCH control settings.
- 7 The LOW/ULTRA-LOW switch sets the subharmonic processor to produce either normal low subharmonics (1 octave) or ultra-low subharmonics (2 octaves). Use the ULTRA-LOW setting only if the used speaker system can handle extremely low frequencies.
- 8 You can adjust the punch or warmth of the generated low frequencies with the BASS MODE control. If the control is turned fully counterclockwise (ULTRA-LOW), only the produced subharmonics are sent to the subwoofer and added to the satellite output (ULTRABASS switch in satellite section "ON"). As you turn the control clockwise (PUNCH), the original low frequencies of the program material are gradually added to the subharmonics, which gives the bass more power and "punch". The optimum setting largely depends on the program material and your personal sound perception. Never hesitate to experiment!
- 9 BASS LEVEL control. With this control you can determine the amount of added bass frequencies, within a range from 0 (full attenuation) to 6 (max. effect). Please observe the power rating of your system!
- 10 BASS LEVEL meter. The amount of generated bass signal is shown by this meter.

Bass limiter section

- 11 The LIMITER IN / OUT switch activates or deactivates the bass limiter. The limiter's task is to protect the loudspeaker system against overloading. In particular, if the system has no separate subwoofer, the level peaks need to be controlled so that extreme diaphragm displacement does not lead to speaker damage.
- 12 THRESHOLD control. The limiter limits the level of the newly generated bass signal to the adjusted value, the threshold control can be set within a range from 0 dB to "OFF" (limiter off).
-  The normal signal is not limited! To prevent damage to your speakers the same safety margin with respect to the output level should be observed as with normal operation without the ULTRABASS PRO.

- 13] **GAIN REDUCTION** meter. This meter indicates that the limiter has been put into operation and is controlling the gain reduction. In this case, it might be wise to reduce the bass level with the LEVEL control. It is also possible to use the limiter to create a desired effect. With the correct settings it is possible to create a so-called loudness effect: At low volumes the ULTRABASS PRO creates additional harmonics and extends the range of the used system and at higher volumes the limiter limits the strain of the created subharmonics to free the maximum sound pressure level of the system.

Satellite section

- 14] The **X-OVER** function acts as a highpass filter in the stereo main path for use in combination with a subwoofer. The activated highpass filter prevents the main speakers (now operating in a multiway active system) from being overloaded by the generated low frequencies. If the X-OVER switch is set to SPLIT, all low-range frequencies below 70 Hz are filtered in the stereo main path, and the newly generated low frequencies are exclusively routed to the subwoofer via the subwoofer output.

However, if the X-OVER function is switched to FULL RANGE, the generated subharmonics can be added to the original stereo signal by depressing the ULTRABASS switch. The low-frequency signal remains present at the subwoofer output.

- 15] **ULTRABASS** switch. With the ULTRABASS switch the generated subharmonics can be led to the satellite loudspeakers. This is useful to create a smooth transition from subwoofer to satellite, or if no subwoofer is used.
- 16] **SATELLITE LEVEL** control. This is the level control for the main speaker system in full range operation and for the satellites in split (x-over) operation.

 **The level of added bass-frequencies present at the satellite output is not dependent on the setting of the SATELLITE LEVEL control. Only the setting of the BASS LEVEL controls the level of subharmonics.**

- 17] **LEFT / RIGHT OUTPUT LEVEL** meter. With these level meters the left and right output level of the ULTRABASS PRO can be monitored.

As mentioned before the ULTRABASS PRO has several controls which influence the sound characteristics of the unit. The FREQUENCY, DYNAMIC PUNCH, SUBHARMONICS and BASS MODE controls change the sound of the ULTRABASS PRO. The other controls govern how much of the effect is audible and how the unit is connected. Please take the time to play around with the ULTRABASS PRO at home or “off line” to get the feel of the possibilities it offers.

1.3.2 Rear Panel

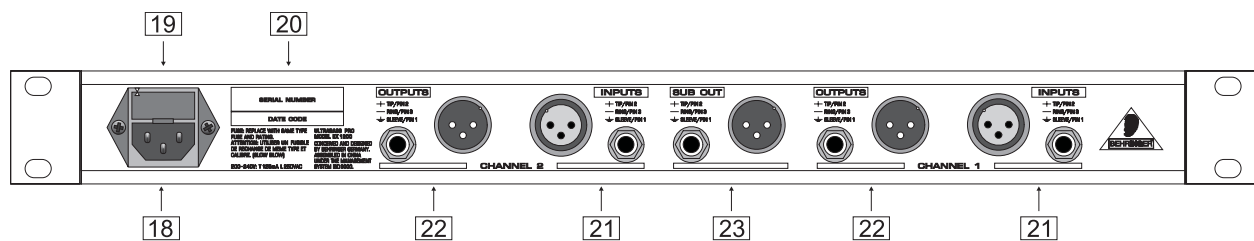

Fig. 1.3: The rear panel layout of the ULTRABASS PRO

- 18] **MAINS CONNECTION.** Use the enclosed power cord to connect the unit to the mains. Please also note the instructions given in the “INSTALLATION” chapter.
- 19] **FUSE HOLDER / VOLTAGE SELECTOR.** Please make sure that your local voltage matches the voltage indicated on the unit, before you attempt to connect and operate the ULTRABASS PRO. Blown fuses may only be replaced by fuses of the same type and rating.
- 20] **SERIAL NUMBER.** Please take the time to have the warranty card filled out completely by your dealer, and return it within 14 days after the date of purchase, so as to be entitled to benefit from our extended warranty.
- 21] **AUDIO IN.** These are the audio inputs of the ULTRABASS PRO. Available on either balanced or unbalanced TRS jacks or XLRs.

- 22 **AUDIO OUT.** These are the audio outputs of the ULTRABASS PRO. Also on either balanced or unbalanced TRS jacks or XLRs.
- 23 **SUBWOOFER OUT.** This is the Subwoofer output for the connection of the subwoofer system. Again on either balanced or unbalanced TRS jacks or XLRs.

2. APPLICATIONS

2.1 Systems without Subwoofer

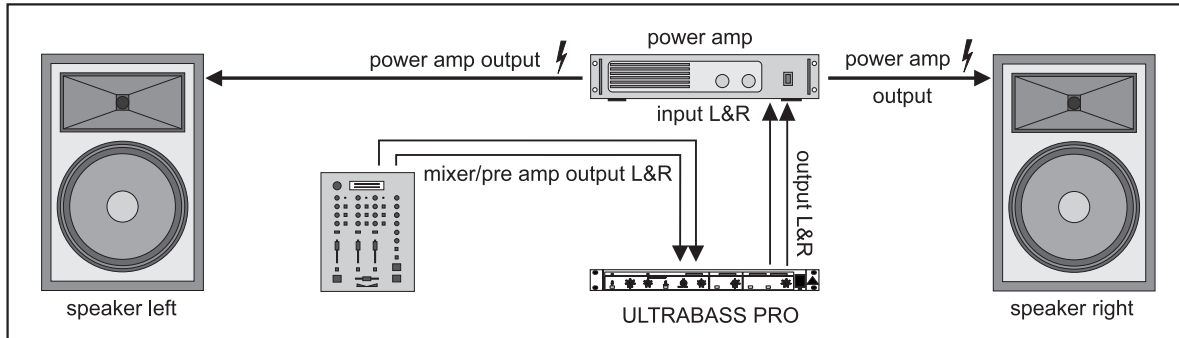

Fig. 2.1: The ULTRABASS PRO in a system without subwoofer

In this standard application, the ULTRABASS PRO is inserted between the mixer or the signal source and the power amplifier. The newly generated low-range frequencies are added to the original signal and are reproduced by the existing system.

Connect the ULTRABASS PRO to your system and set up the controls and switches as follows:

Control	Position
Process	OUT
Frequency	120
Dynamic Punch	0
Subharmonics	LOW
Bass Mode	CENTER
Bass Level	0
Limiter	IN
Threshold	OFF
X-Over	FULL RANGE
Ultrabass	OUT
Satellite Level	0

Tab. 2.1: Start up settings

Now, depress the PROCESS switch and turn the DYNAMIC PUNCH control clockwise until the ACTIVE LED lights up. Now turn the BASS LEVEL up until the desired low-range frequencies can be heard. Turn the THRESHOLD control in the Bass Limiter Section counter-clockwise until the first two LEDs of the gain reduction meter light up. By using the SUBHARMONICS switch and the BASS MODE control you can now adapt the bass sound to the program material and to your personal sound perception. With the FREQUENCY control you adjust the highest frequency of the program material which is sent to the subharmonic synthesizer. It thereby also governs the highest frequency reproduced by the subwoofer if one is attached.

Generally speaking, the setting of the FREQUENCY and DYNAMIC PUNCH controls is

dependent on the program material. The setting of the **SUBHARMONICS** switch is dependent on the capabilities of the loudspeaker or subwoofer system. The setting of the **BASS MODE** control is dependent on you, the listener.

Most important rule is to take familiar material and experiment at home or before actually use to get the feel of the ULTRABASS PRO and what the unit can do for you.

2.2 Systems with Subwoofer

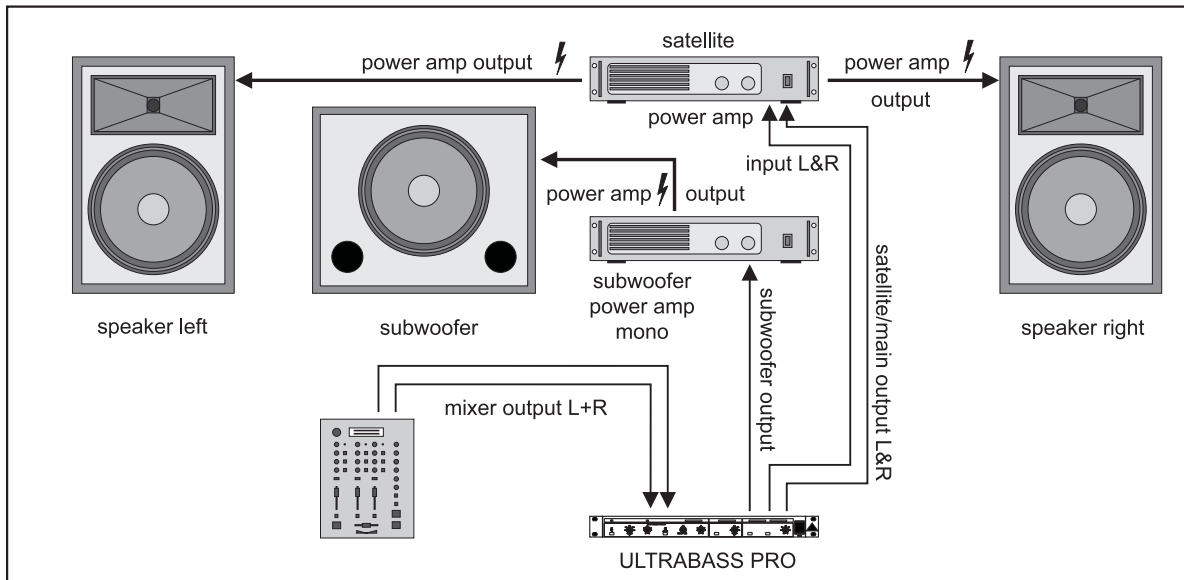

Fig. 2.2: The ULTRABASS PRO in a system with subwoofer

In this application, the low-range frequencies are reproduced both by the main speakers and by an additional subwoofer. A subwoofer is a special loudspeaker for the transmission of low-frequency signals and serves as an additional loudspeaker to improve the system response in the bass range.

For this purpose, the ULTRABASS PRO is equipped with an additional subwoofer output, which only provides the original low-range frequencies and the newly generated subharmonics within a frequency range from 15 to 90 Hz. The subwoofer output is a mono output, since low-frequency signals contain virtually no directional information. Nevertheless, the subwoofer should be positioned centrally to guarantee constant loudness in the dispersion area.

Since in this application the entire low-frequency range is also reproduced by the main speakers, it should be ensured that the low-range loudspeakers are not overloaded.

👉 When using a subwoofer with full range speakers, problems can rise in which the speakers and the subwoofer cancel each other out at certain frequencies and positions. To check this, walk around the room and listen to the difference between X-OVER switched on and off.

2.3 Multiway Active System

We talk of an active system, if the frequency spectrum is split up into several different ranges, and if specific loudspeakers are used to reproduce just one selected range from the audio spectrum. Active operation is particularly useful in large-scale sound systems found in discotheques, cinemas and theatres etc. The following illustration shows the basic setup for multiway active operation.

The signal is routed from the mixer (or from any other sound source) to the ULTRABASS PRO. By activating the X-OVER switch, all frequencies below 70 Hz are filtered out and are reproduced by a subwoofer. The remaining signal is routed via the satellite outputs of the ULTRABASS PRO to the subsequent crossover networks of the active system, where it is split up into a low and high-frequency range. The crossover is used to split up the remaining frequency bands even further, and can be omitted in less complex systems using passive crossovers.

ULTRABASS PRO EX1200

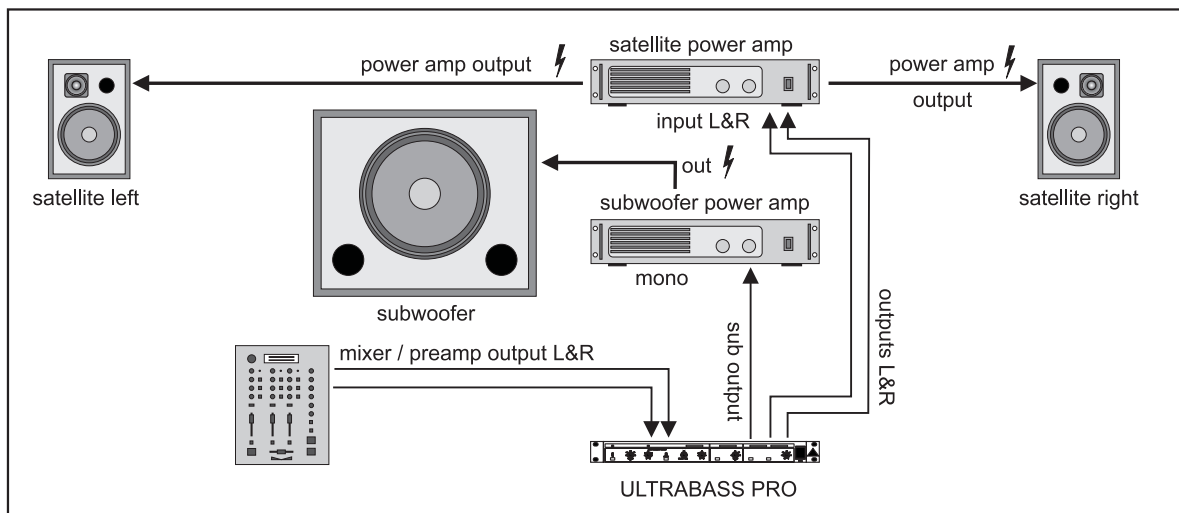

Fig. 2.3: The ULTRABASS PRO in a satellite system

2.4 The ULTRABASS PRO in a Hi-Fi System

The following illustration shows how the ULTRABASS PRO is connected to your hi-fi stereo system. If possible, insert the unit into the "tape monitor" path, which allows for controlling the sound of all signal sources connected to the inputs of the amplifier.

Alternatively some integrated amplifiers have special preamp out / power amp in connectors. It is also possible to connect the ULTRABASS PRO between your CD, cassette player, etc. and your amplifier. In all cases you will need four cinch-to-jack cables.

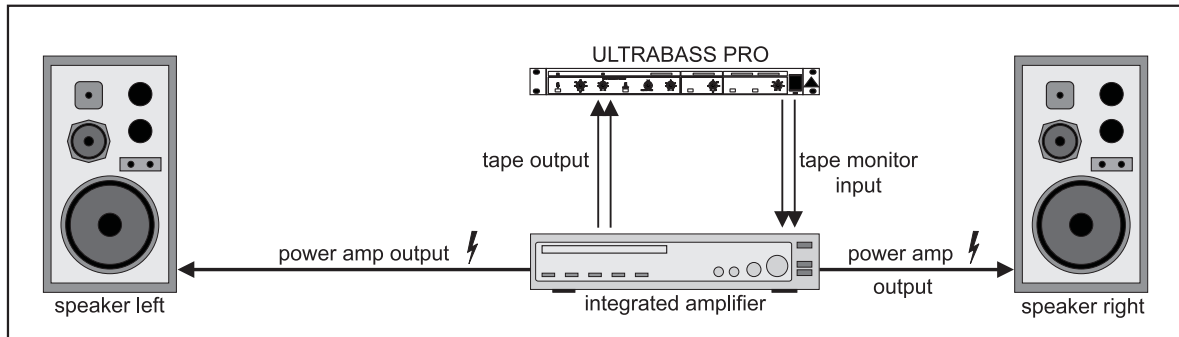

Fig. 2.4: The ULTRABASS PRO in a hi-fi system

3. TECHNICAL BACKGROUND

3.1 The Integrated Frequency Crossover

The BEHRINGER ULTRABASS PRO features an integrated crossover network which permits extraction of the bass frequencies. In 70 Hz SPLIT mode, all frequencies below 70 Hz are removed from the two main paths, with a slope of 12 dB/octave. The system is thus operated in a multiway active system. Via the separate subwoofer output, all bass frequencies can now be routed to a special low-frequency loudspeaker (subwoofer). When in full range mode, the subwoofer output can be used to enhance the bass produced by the left and right channel speakers.

 **When using a subwoofer with full range speakers, problems can arise in which the speakers**

and the subwoofer cancel each other out at certain frequencies and positions. To check this, walk around the room and listen to the difference between X-OVER switched on and off. It is therefore possible to hear more bass without a subwoofer or by using the crossover function even with full range speakers.

3.2 The Integrated Limiter

Devices of this kind produce bass frequencies with hazardous levels, which can overload or damage your loudspeaker systems. For this reason, the ULTRABASS PRO integrates a level limiter which monitors and if necessary reduces the low-frequency level of the generated output signal. The limiter controls both temporary signal peaks to avoid distortion, as well as constant overloading to prevent the speakers from being damaged. If excessive signal levels are detected, the limiter follows the THRESHOLD setting and reduces the output signal amplitude to a value below distortion. The setting of this control depends on numerous factors, such as level and low-frequency contents in the program material, overall level, the amplifier's capacity, the loudspeaker's power rating etc. As a rule of thumb it is recommended to adjust the THRESHOLD control so that the first two LEDs of the gain reduction meter light up. The setting should be checked by ear.

In addition to its function as a protection device, the limiter can also be used as an effect to provide constant power. For this purpose, the THRESHOLD control is adjusted in such a way that the limiter responds all the time and thus provides a constant low-frequency level, without losing the dynamic punch of the program material. In this setup, it should be observed that a correct ratio between the BASS LEVEL and THRESHOLD controls is maintained.

 **Be careful when using the ULTRABASS PRO: excessive use can damage your loudspeaker system. The low-frequency signals produced by the ULTRABASS PRO can highly stress both amplifier and low-frequency speakers. So, do not exaggerate the effect, use the integrated limiter and observe the power rating of your system!**

4. INSTALLATION

4.1 Audio Connections

The audio inputs and outputs on the BEHRINGER ULTRABASS PRO are fully balanced. If possible, connect the unit to other devices in a balanced configuration to allow for maximum interference immunity.

 **Please ensure that only qualified persons install and operate the ULTRABASS PRO. During installation and operation the user must have sufficient electrical contact to earth. Electrostatic charges might affect the operation of the ULTRABASS PRO!**

You will find further information in chapter 1.2 "Before you begin".

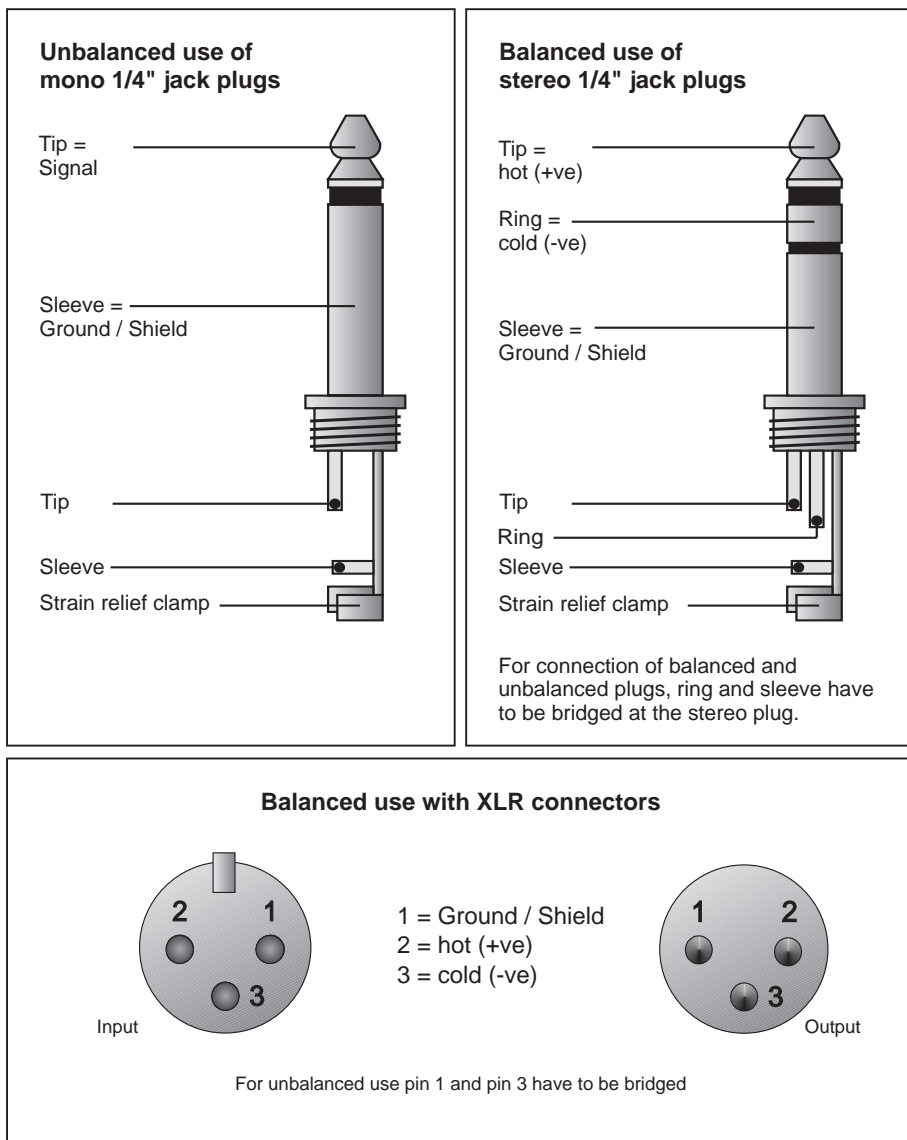

Fig. 4.1: Different plug types

5. SPECIFICATIONS

Audio input

Connectors	XLR and 1/4" TRS
Type	RF filtered, servo balanced input
Impedance	50 kOhms balanced, 25 kOhms unbalanced
Max. input level	+21 dBu balanced and unbalanced (unity gain)
CMRR	typ. 40 dB, >55 dB @ 1 kHz

Audio output

Connectors	XLR and 1/4" TRS
Type	electronically servo-balanced output stage. Automatic level correction for unbalanced use (6 dB).
Impedance	60 Ohms balanced, 30 Ohms unbalanced
Max. output level	+21 dBu, +20 dBm balanced and unbalanced

System specifications

Frequency response	16 Hz to 150 kHz, +/- 3 dB
Noise	>-95 dBu, unweighted, 22 Hz to 22 kHz
THD	0.001 % typ. @ +4 dBu, 1 kHz, Gain 1 0.04 % typ. @ +20 dBu, 1 kHz, Gain 1
IMD	0.01 % typ. SMPTE
Crosstalk	<-70 dB, 22 Hz to 22 kHz

Satellite high pass filter

Type	butterworth characteristics, 12 dB/Oct.
Cut-off frequency	70 Hz

Subharmonic synthesizer

Type	digital frequency shifter with waveform synthesizer
LEVEL control	variable (0 to 6)

Limiter

Type	limiter for the subharmonic synthesizer
Attack time	program dependent
Release time	20 dB/s
THRESHOLD control	variable (-6 dB to OFF)

Power supply

Mains voltages	USA/Canada	120 V ~, 60 Hz
	U.K./Australia	240 V ~, 50 Hz
	Europe	230 V ~, 50 Hz
	General export model	100-120 V ~, 200-240 V ~, 50-60 Hz
Fuse	100-120 V ~	T 250 mA H
	200-240 V ~	T 125 mA H
Power consumption	max. 20 Watts	
Mains connection	standard IEC receptacle	

Physical

Dimension (H, * W, * D)	1 3/4" (44.5 mm) * 19" (482.6 mm) * 8 1/2" (217 mm)
Net weight	2.2 kg
Shipping weight	3.4 kg

BEHRINGER is constantly striving to maintain the highest professional standards. As a result of these efforts, modifications may be made from time to time to existing products without prior notice. Specifications and appearance may differ from those listed or shown.

9. WARRANTY

§ 1 WARRANTY CARD/ONLINE REGISTRATION

To be protected by the extended warranty, the buyer must complete and return the enclosed warranty card within 14 days of the date of purchase to BEHRINGER Spezielle Studiotechnik GmbH, in accordance with the conditions stipulated in § 3. Failure to return the card in due time (date as per postmark) will void any extended warranty claims.

Based on the conditions herein, the buyer may also choose to use the online registration option via the Internet (www.behringer.com or www.behringer.de).

§ 2 WARRANTY

1. BEHRINGER (BEHRINGER Spezielle Studiotechnik GmbH including all BEHRINGER subsidiaries listed on the enclosed page, except BEHRINGER Japan) warrants the mechanical and electronic components of this product to be free of defects in material and workmanship for a period of one (1) year from the original date of purchase, in accordance with the warranty regulations described below. If the product shows any defects within the specified warranty period that are not due to normal wear and tear and/or improper handling by the user, BEHRINGER shall, at its sole discretion, either repair or replace the product.

2. If the warranty claim proves to be justified, the product will be returned to the user freight prepaid.

3. Warranty claims other than those indicated above are expressly excluded.

§ 3 RETURN AUTHORIZATION NUMBER

1. To obtain warranty service, the buyer (or his authorized dealer) must call BEHRINGER (see enclosed list) during normal business hours **BEFORE** returning the product. All inquiries must be accompanied by a description of the problem. BEHRINGER will then issue a return authorization number.

2. Subsequently, the product must be returned in its original shipping carton, together with the return authorization number to the address indicated by BEHRINGER.

3. Shipments without freight prepaid will not be accepted.

§ 4 WARRANTY REGULATIONS

1. Warranty services will be furnished only if the product is accompanied by a copy of the original retail dealer's invoice. Any product deemed eligible for repair or replacement by BEHRINGER under the terms of this warranty will be repaired or replaced within 30 days of receipt of the product at BEHRINGER.

2. If the product needs to be modified or adapted in order to comply with applicable technical or safety standards on a national or local level, in any country which is not the country for which the product was originally developed and manufactured, this modification/adaptation shall not be considered a defect in materials or workmanship. The warranty does not cover any such modification/adaptation, irrespective of whether it was carried out properly or not. Under the terms of this warranty, BEHRINGER shall not be held responsible for any cost resulting from such a modification/adaptation.

3. Free inspections and maintenance/repair work are expressly excluded from this warranty, in particular, if caused by improper handling of the product by the user.

This also applies to defects caused by normal wear and tear, in particular, of faders, potentiometers, keys/buttons and similar parts.

4. Damages/defects caused by the following conditions are not covered by this warranty:

- ▲ misuse, neglect or failure to operate the unit in compliance with the instructions given in BEHRINGER user or service manuals.

- ▲ connection or operation of the unit in any way that does not comply with the technical or safety regulations applicable in the country where the product is used.

- ▲ damages/defects caused by force majeure or any other condition that is beyond the control of BEHRINGER.

5. Any repair or opening of the unit carried out by unauthorized personnel (user included) will void the warranty.

6. If an inspection of the product by BEHRINGER shows that the defect in question is not covered by the warranty, the inspection costs are payable by the customer.

7. Products which do not meet the terms of this warranty will be repaired exclusively at the buyer's expense. BEHRINGER will inform the buyer of any such circumstance. If the buyer fails to submit a written repair order within 6 weeks after notification, BEHRINGER will return the unit C.O.D. with a separate invoice for freight and packing. Such costs will also be invoiced separately when the buyer has sent in a written repair order.

§ 5 WARRANTY TRANSFERABILITY

This warranty is extended exclusively to the original buyer (customer of retail dealer) and is not transferable to anyone who may subsequently purchase this product. No other person (retail dealer, etc.) shall be entitled to give any warranty promise on behalf of BEHRINGER.

§ 6 CLAIM FOR DAMAGES

Failure of BEHRINGER to provide proper warranty service shall not entitle the buyer to claim (consequential) damages. In no event shall the liability of BEHRINGER exceed the invoiced value of the product.

§ 7 OTHER WARRANTY RIGHTS AND NATIONAL LAW

1. This warranty does not exclude or limit the buyer's statutory rights provided by national law, in particular, any such rights against the seller that arise from a legally effective purchase contract.

2. The warranty regulations mentioned herein are applicable unless they constitute an infringement of national warranty law.

The information contained in this manual is subject to change without notice. No part of this manual may be reproduced or transmitted in any form or by any means, electronic or mechanical, including photocopying and recording of any kind, for any purpose, without the express written permission of BEHRINGER Spezielle Studiotechnik GmbH.

BEHRINGER is a registered trademark. ALL RIGHTS RESERVED.

© 2001 BEHRINGER Spezielle Studiotechnik GmbH.

BEHRINGER Spezielle Studiotechnik GmbH, Hanns-Martin-Schleyer-Str. 36-38, 47877 Willich-Münchheide II, Germany

Tel. +49 (0) 21 54 / 92 06-0, Fax +49 (0) 21 54 / 92 06-30

Free Manuals Download Website

<http://myh66.com>

<http://usermanuals.us>

<http://www.somanuals.com>

<http://www.4manuals.cc>

<http://www.manual-lib.com>

<http://www.404manual.com>

<http://www.luxmanual.com>

<http://aubethermostatmanual.com>

Golf course search by state

<http://golfingnear.com>

Email search by domain

<http://emailbydomain.com>

Auto manuals search

<http://auto.somanuals.com>

TV manuals search

<http://tv.somanuals.com>