

# Kitchener

90 Ceramic

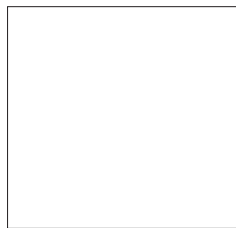

## Users Guide

&

Installation & Service Instructions

U109720 - 01



[www.rangemaster.co.uk](http://www.rangemaster.co.uk)

## **Be safe**

### **Warning**

**Accessible parts will become hot in use. To avoid burns and scalds children should be kept away**

Do not stand or rest heavy objects on the ceramic hob. Although the ceramic surface is very strong, a sharp blow or sharp falling object might cause the surface to crack or break.

**As soon as any crack in the surface becomes visible disconnect the appliance immediately from the supply and arrange for its repair.**

Care should be taken that no water seeps into the appliance.

During use, and afterwards, the appliance will be warm, so be careful with little children. If the younger members of your family are allowed into the kitchen we strongly advise that they are kept under supervision at all times.

We recommend you read 'General Safety Instructions' (especially if you have not used a ceramic cooker before) where we describe some basic guidelines on how to use your cooker safely.

## **Electricity on**

Make sure that the cooker is wired in and switched on.

## **Peculiar smells**

When you first use your cooker it may give off a slight odour. This should stop after a little use.

**Before using for the first time, make sure that all packing materials have been removed and then to dispel manufacturing odours, turn the ovens to 230°C and run for an hour.**

**Before using the grill for the first time you should also turn on the grill and run for 30 minutes with the grill pan in position, pushed fully back, and the grill door open.**

**Make sure the room is well ventilated to the outside air, by opening windows or turning on a cooker hood for example. We recommend that people with respiratory or allergy problems should vacate the area for this brief period.**Warning

# Contents

---

## User Guide

The Hob	Page 4
The Grill	Page 6
The Ovens	Page 7
The Clock	Page 8
Cooking using the timer	Page 9
Main Oven shelves	Page 10
The Handyrack	Page 11
Oven light	Page 11
Tall oven shelves	Page 12
Oven cooking guide	Page 13
Cleaning your cooker	Page 14
Moving your cooker	Page 16
Troubleshooting	Page 17
General Safety Instructions	Page 19

<u>Installation</u>	Page 21
Servicing	Page 26
Technical Data	Page 31
Circuit Diagram	Page 32

# The Hob

When you cook on a ceramic hob its very important to use the right sort of pans...

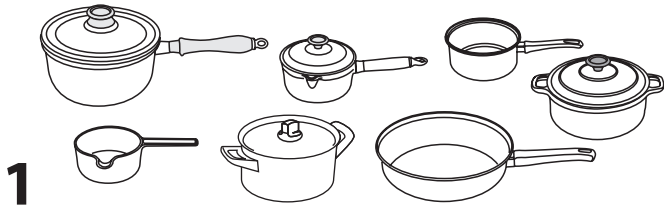

1

Use only pans that are suitable for ceramic hobs. We recommend stainless steel and enamelled steel pans because pots and pans with copper or aluminium bases leave traces on the hob that are difficult to remove. Glass-ceramic cookware is not suitable because of its poor conductivity.

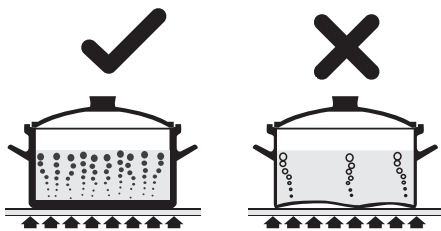

2

Pots and pans should have thick, smooth, flat bottoms. This ensures that there is the maximum heat transfer from the hob to the pan, making cooking quick and energy efficient.

Never use a round bottomed Wok even with a stand.

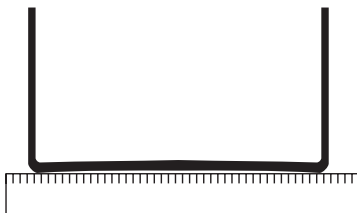

3

The very best pans have bases that are very slightly curved in when cold. If you hold a ruler across the bottom you will see a small gap in the middle. When they heat up the metal expands and lies flat on the cooking surface.

Make sure that the base of the pan is clean and dry to prevent any residue burning onto the hob panel. This also helps prevent scratches and deposits (such as lime specks).

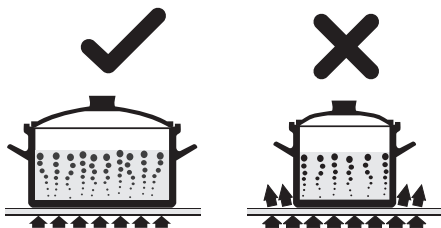

4

Always use pans that are the same size as (or slightly larger than) the areas marked on the hob top. Using smaller pans wastes heat, and any spillage will be burnt on. Using a lid will help the contents boil more quickly.

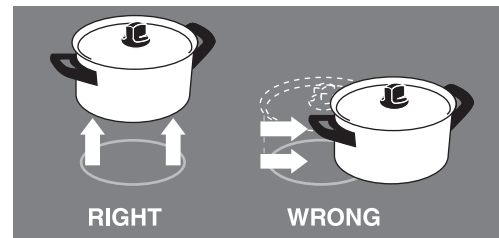

5

Always lift pans off the hob. Sliding pans may cause marks and scratches. Always turn the control to the off position before removing a pan.

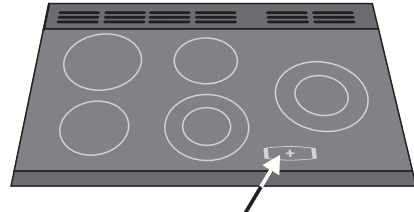

6

There are indicator lights for each of the cooking areas. These come on when a hob control is turned on and stay lit while the surface cools. Always take care before touching the surface even when it is turned off - it may be hotter than you think.

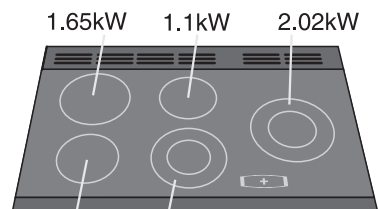

7

The ratings of the cooking areas are shown on the diagram above.

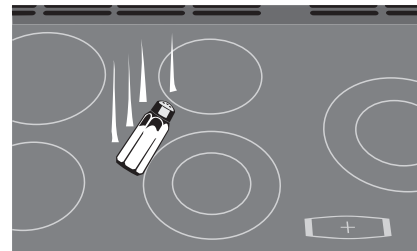

8

Although the ceramic surface is very strong, a heavy or sharp falling object (a salt cellar for example) might cause the surface to crack. If you find a crack in the surface **immediately** disconnect the appliance from the supply and arrange for its repair.

Care should be taken that no water seeps into the appliance.

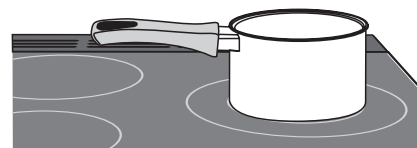

9

The areas marked with two concentric circles have an inner and an outer element. Turn the control knob clockwise to heat the whole area for larger pans - turn it the other way to just heat the inner part for smaller pans.

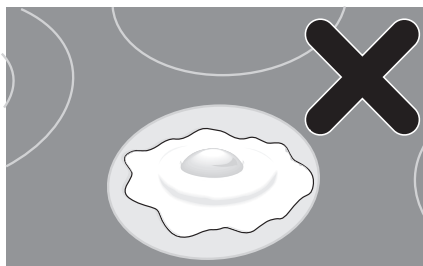
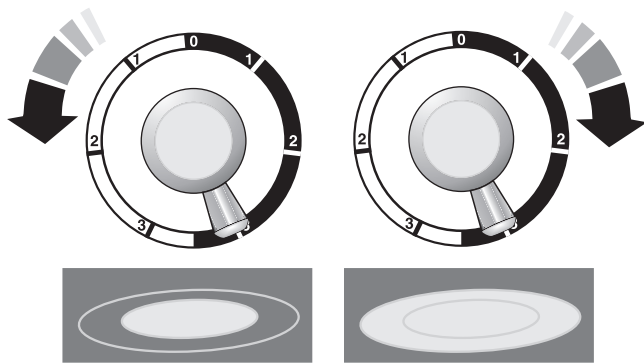

**10**

Never cook directly on the surface.

The kind of pan you use and the quantity of food affects the setting required. Higher settings are required for larger quantities of food.

Naturally, the surface must be washed after use in order to prevent it from becoming scratched or dirty.

When cooking on the hob you may see the hob area you are using switch off and on. This is caused by a safety device that limits the temperature of the hob. It is quite normal, especially when cooking at high temperatures. If it happens a lot with a particular pan however it may mean the pan is not suitable – perhaps too small or too uneven - for a ceramic hob.

Sugar spillage will permanently damage the hob and therefore must be cleaned off with care immediately. Never let sugar spillage cool before trying to remove it.

If sugar or foods with high sugar content, aluminium foil or plastic items are accidentally allowed to melt on the hob surface remove them immediately from the hot cooking area using a scraper to avoid any possible damage to the surface. See 'Cleaning your cooker'.

**Never** cut directly on the cooking surface.

**Don't** cook directly on the hob surface i.e. without a pan or utensil

**Don't** use the hob as a work surface

**Don't** drag or slide utensils across the hob surface

**Don't** place anything between the base of the pan and the hob surface (i.e. asbestos mats, aluminium foil, Wok stand)

**Don't** leave utensils, foodstuffs or combustible items on the hob when it is not in use. (e.g. tea towels, frying pans containing oil)

**Don't** place plastic or aluminium foil, or plastic containers on the hob

**Don't** leave the hob zones switched on unless being used for cooking

**Don't** place large preserving pans or fish kettles across two heating zones

**Don't** place utensils partly covering a heating zone. Always place utensils centrally.

**Never** allow anyone to climb or stand on the hob.

# The Grill

**Caution: Accessible parts may be hot when the grill is in use. Young children should be kept away.**

Remove the pan from the bottom of the grill compartment.

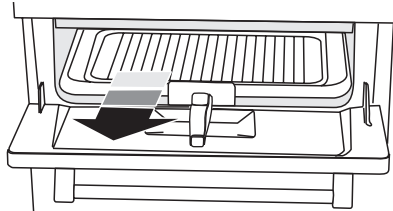

After placing your food on the grill tray pan, slide the grill pan onto the side supports just below the elements. Make sure it is pushed right in and touches the back stop.

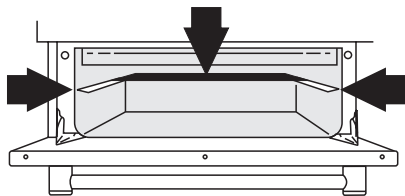

The grill has two elements that allow either the whole area of the pan to be heated or just the right hand half. To heat the whole grill, turn the knob clockwise to position 3.

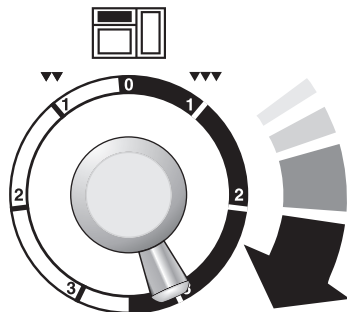

To heat the right hand half turn it anticlockwise.

For best results preheat for 2 minutes with the grill pan in position. After placing your food on the grill pan grid, slide the grill pan onto the side supports. Adjust the heat to suit by turning the knob.

Make sure it is pushed right in and touches the back stop.

Never close the grill door when the grill is on.

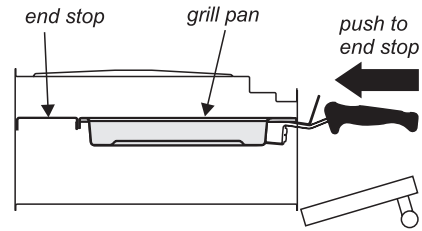

The grill pan grid can be turned over to give two grilling positions.

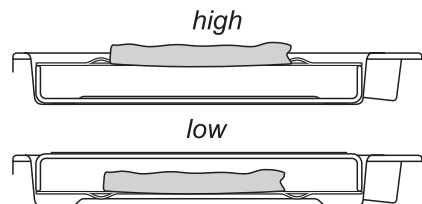

Don't leave the grill on for more than a few moments, without the grill pan underneath it.

*For best results, especially with toast, preheat the grill with the grill pan in the cooking position for two minutes before use.*

The grill trivet can be removed and the food placed on it while you are waiting for the grill to preheat.

*The grill pan grid can be turned over to give two grilling positions.*

You can brown the top of dishes cooked in the oven, under the grill by placing the dish onto the base of the grill pan, which can easily slide along the floor of the grill cavity.

# The Ovens

During use the appliance becomes hot. Care should be taken to avoid touching heating elements inside the oven.

**Before using for the first time, to dispel manufacturing odours, turn the ovens to 230°C and run for an hour. To clear the smell, make sure the room is well ventilated to the outside air, by opening windows or turning on a cooker hood for example. We recommend that people with respiratory or allergy problems should vacate the area for this brief period.**

The clock must be set to the time of day before the right hand fan oven will work. See 'The Clock' section for instructions on setting the time of day.

Turn the oven knob to the temperature you need.

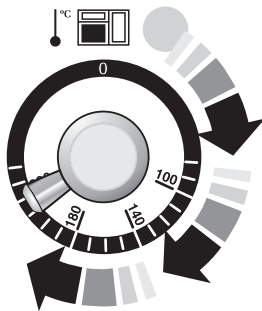

The oven indicator light will glow until the oven has reached the temperature you selected. It will then cycle on and off during cooking.

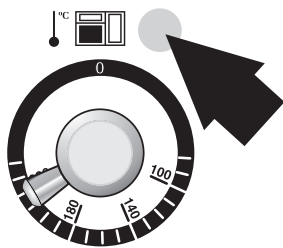

During cooking, food naturally produces steam, particularly when cooking foods with high water content (e.g. oven chips). There may be some steam visible at the grille at the rear of the hotplate. This is perfectly normal. As this steam can condense to water droplets on the cool outer trim of the oven, it may be necessary during cooking to wipe away any moisture with a soft cloth. This will also help to prevent soiling and discolouration of the oven exterior by cooking vapours.

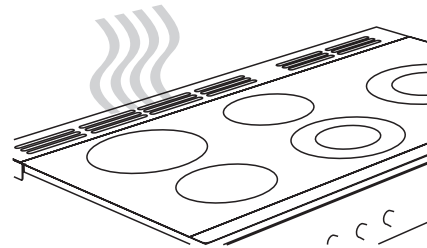

The fans in both ovens circulate hot air continuously, which means faster more even cooking.

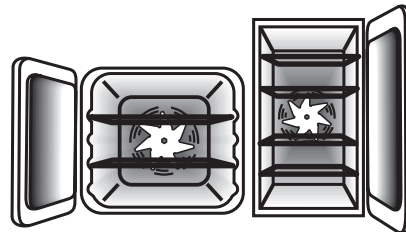

The recommended cooking temperatures for a fanned oven are generally lower than a non-fanned oven.

Whole chickens and large joints of meat should be defrosted in the refrigerator. Do not defrost in a warm oven or whilst the adjoining oven is hot.

# The Clock

You can use the timer to turn the left hand Main Oven on and off. The clock must be set to the time of day before the right hand fan oven will work.

## To set the time of day

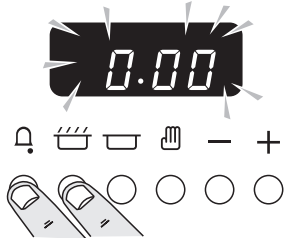

Press and hold as above. At the same time, press (-) or (+) until the correct time shows. Don't forget it's a 24 hour clock. If you make a mistake or press the wrong button, turn off the power supply for a minute or two and start again.

## To time something that's cooking (minute minder)

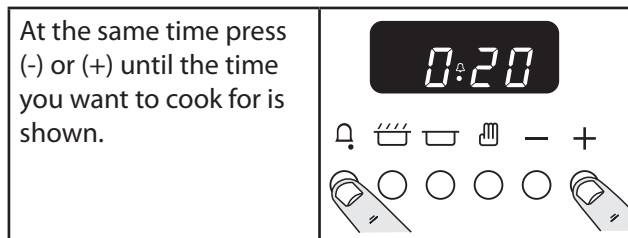
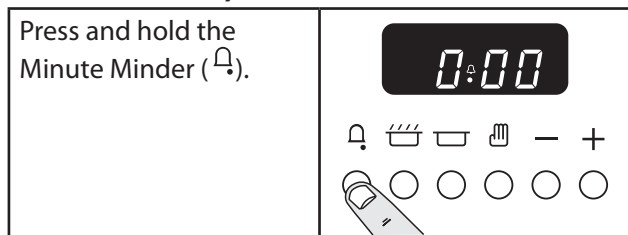

You can check time remaining by pressing 🔔 and cancel the beeper by pressing 🔔

## To stop automatically

Use when you have started the oven manually.

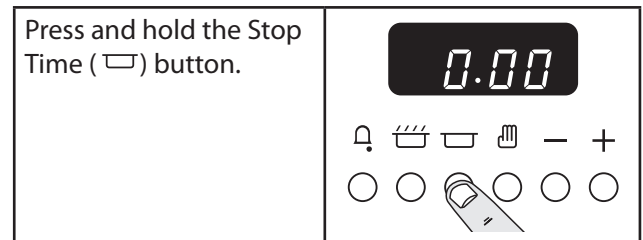

At the same time press (-) or (+) until your required 'Stop Time' shows. AUTO will show in the display. When your cooking is finished the beeper sounds. TURN THE OVEN KNOB TO 0 FIRST, then press 🔔 once to stop the beep, press 🔔 again to return to manual cooking.

## To start and stop the oven automatically

Before you set the clock, you must have two numbers clearly in mind.

The 'Cook Time', which is the period of time you want the oven to cook.

The 'Stop Time', which is the time of day you want the oven to stop cooking.

You cannot set a start time directly - this is set automatically by setting the cooking period and stop time.

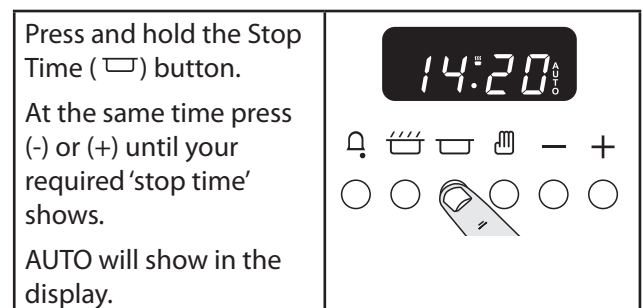
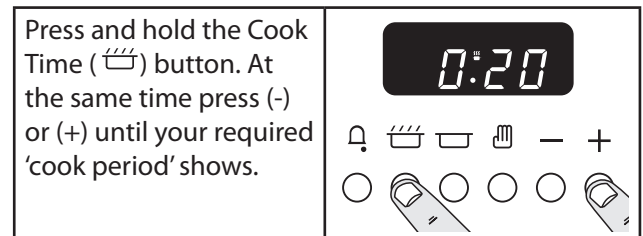

Set the oven to the required temperature. When your cooking is finished the beeper sounds. TURN THE OVEN KNOB TO 0 (off) FIRST, then press 🔔 once to stop the beep, press 🔔 again to return to manual cooking.



If you are out, don't worry about the beeper going off, it stops after a while. When you return, TURN THE OVEN KNOB TO 0 (off) FIRST, then press  twice, to return to manual cooking.

## AUTO is showing, you want to reset to manual cooking.

When cancelling an automatic setting, any cooking time already set must be returned to 0.00 before you can return to manual, by pressing the  button.



## Clock Special Features

### Key Lock

When the key lock is activated, the clock can be operated as usual but the oven is locked and will not come on. This means that your child could select a cook program but the program will not be activated and oven will not be switched on.

### To activate the key lock

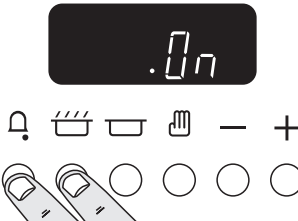

Make sure that the clock is in manual mode and cancel any active programs.

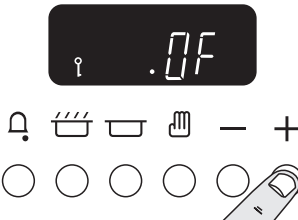
<p>Hold the Minute Minder () and Cooktime () buttons for about 8 seconds.</p> <p>'On' will appear on the display.</p>	
--	--

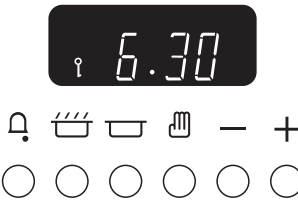
<p>Press the '+' button once.</p> <p>The key symbol () and 'Of' will appear on the display. Let go of the buttons.</p>	
---	---

<p>The clock oven control functions are now locked.</p> <p>After a few seconds the display will revert to show the time of day and the key symbol ().</p>	
--	---

### To turn off the key lock

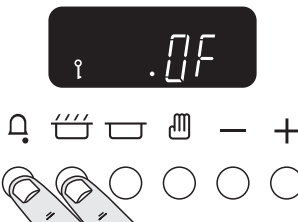
<p>Hold the Minute Minder () and Cooktime () buttons for about 8 seconds.</p> <p>'Of' will appear on the display.</p>	
---	---

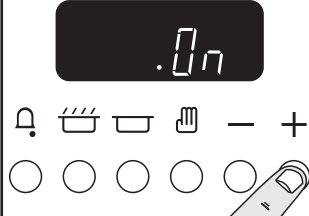
<p>Press the '+' button once. The key symbol () goes out and 'On' shows on the display.</p> <p>Let go of the buttons</p>	
---	---

After a few seconds the display will revert to show the time of day.

The oven and the clock oven control functions can now be used normally.

## Cooking using the timer

The timer can control the left hand Main oven only.

You can set the oven to turn on any time over the following 24 hour period

*If you want to cook more than one dish, choose dishes that require approximately the same time. However, dishes can be 'slowed down' slightly by using small containers and covering them with aluminium foil, or 'speeded up' slightly by cooking smaller quantities or placing in larger containers.*

Very perishable foods such as pork or fish should be avoided if a long delay period is planned, especially in hot weather.

*Don't place warm food in the oven.*

*Don't use an oven already warm.*

*Don't use if an adjoining oven is warm.*

Avoid using wine or beer if there is a delay period, as fermentation may take place.

*To avoid curdling, cream should be added to dishes just before serving.*

Fresh vegetables, which may discolour during a delay period, should be coated in melted fat or immersed in a water and lemon juice solution.

Fruit pies, custard tarts or similar wet mixtures on top of uncooked pastry are only satisfactory if there is a short delay period. Dishes containing leftover cooked meat or poultry should not be cooked automatically if there is a delay period.

Whole poultry must be thoroughly defrosted before placing in the oven.

Check that meat and poultry are fully cooked before serving.

## Both Ovens

**Before using for the first time, to dispel manufacturing odours turn the ovens to 230°C and run for an hour. To clear the smell make sure the room is well ventilated to the outside air, by opening windows for example.**

Both ovens are fanned ovens. The fan circulates hot air continuously which results in faster heat transfer to the food.

The wire shelves should always be pushed firmly to the back of the oven.

*Baking trays meat tins etcetera should be placed level centrally on the oven's wire shelves. Keep all trays and containers away from the sides of the oven, as overbrowning of the food may occur.*

For even browning, the maximum recommended size of a baking tray is 340mm by 340mm for the main oven and 230mm by 320mm for the Tall oven.

*Cooking high moisture content foods can create a 'steam burst' when the oven door is opened. When opening the oven stand well back and allow any steam to disperse.*

When the oven is on, don't leave the door open for longer than necessary, otherwise the knobs may get very hot.

- Always leave a 'fingers width' between dishes on the same shelf. This allows the heat to circulate freely around them.
- The Cook & Clean oven liners (see Cleaning your cooker) work better when fat splashes are avoided. Cover meat when cooking.



- To reduce fat splashing when you add vegetables to hot fat around a roast, dry them thoroughly or brush lightly with cooking oil.
- If you want to brown the base of a pastry dish, preheat a baking tray for 15 minutes before placing the dish in the centre of the tray.
- Where dishes may boil and spill over during cooking, place them on a baking tray.

## Main Oven shelves

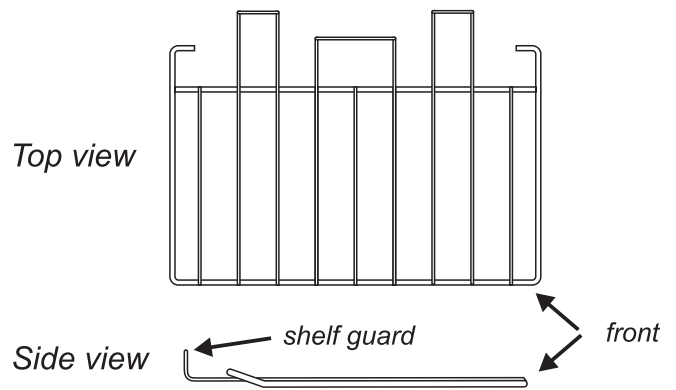

the shelf guard should be at the back pointing upwards

As well as the flat shelf some models are supplied with a drop shelf. The drop shelf increases the possibilities for oven shelf spacing.

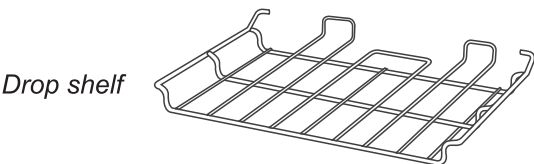
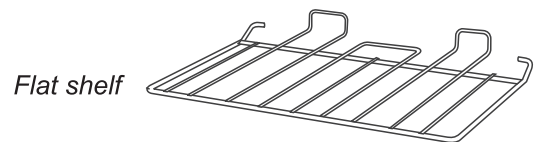

The oven shelves can be easily removed and refitted.

Pull the shelf forward until the back of the shelf is stopped by the shelf stop bumps in the oven sides.

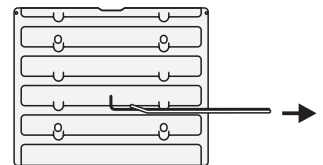

Lift up the front of the shelf so the back of the shelf will pass under the shelf stop and then pull the shelf forward.

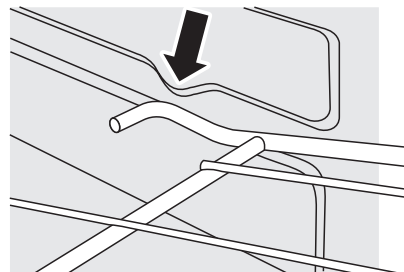
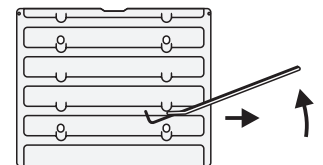

To refit the shelf, line up the shelf with a groove in the oven side and push the shelf back until the ends hit the shelf stop. Lift up the front so the shelf ends clear the shelf stops, and then lower the front so that the shelf is level and push it fully back.

## The Handyrack

The maximum weight that can be held by the Handyrack is 5.5kg (12lb). It should only be used with the supplied meat tin, which is designed to fit the Handyrack. Any other vessel could be unstable.

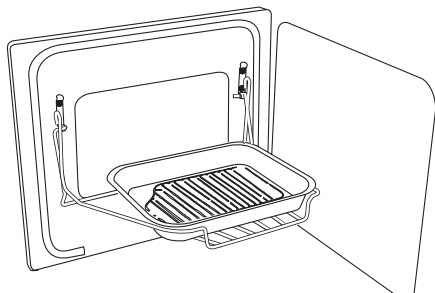
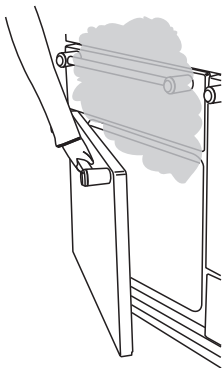

The Handyrack fits to the left hand Main Oven door only. Food cooking on it is easy to attend to, because it's accessible when the door is open. It can be fitted at two different heights. One of the oven shelves must be removed and the other positioned to suit.

When the Handyrack is used in its highest position, other dishes can be cooked on the bottom shelf position of the oven or standing on the base of the oven

When the Handyrack is used in its lowest position, other dishes can be cooked on the second shelf position of the oven or standing on the base of the oven.

To fit the Handyrack, locate one side of it on the door bracket.

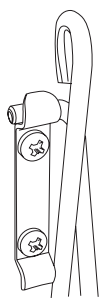
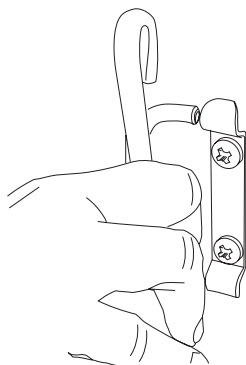

Then spring the other side out to clip it onto the other bracket.

## Oven light



Press the button to turn on the oven light.

If the Main oven light fails, turn off the power supply before you change the bulb. See the 'Troubleshooting' section for details on how to change the oven light bulb.

## Tall oven shelves

The tall oven is supplied with four normal cooking shelves

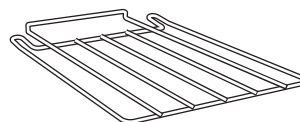

and a plate warming shelf.

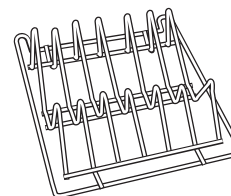

When using the tall oven you can cook on all four shelves at the same time; but make sure they are well spaced out to allow the hot air to circulate.

*The oven control settings and cooking times given in the table opposite are intended to be used only as a guide. Individual tastes may require the temperature to be altered to provide a preferred result.*

*Food is cooked at lower temperature in a fan oven than in a conventional oven. When using recipes, reduce the temperature by 10°C and the cooking time by 5-10 minutes. The temperature in a fanned oven does not vary with height in the oven - so you can use any shelf.*

*Always leave at least one runner space between shelves when 2 tier cooking. Place baking trays, individual cake tins or baking dishes centrally on the oven shelf. For best results pre-heat the oven until the oven indicator light goes out.*

# Oven cooking guide

Food	Main & Tall Oven Temperature	Approximate Cooking Time
<b>FISH</b>		
	180°C	Fillets 15-20mins.
	180°C	Whole 10mins.per 500g + 10mins.
	180°C	Steaks according to thickness.
<b>ROAST MEATS</b>		
Beef with bone	150°C	20-25mins. per 500g + 20-25mins.
	190°C	15-20mins. per 500g + 15-20mins.
Beef without bone	150°C	30-35mins. per 500g + 30-35mins.
	190°C	20-25mins. per 500g + 20-25mins.
Lamb	170°C	30-35mins. per 500g + 30-35mins.
	190°C	25-35mins. per 500g + 25-30mins.
Pork	150°C	35-40mins. per 500g + 35-40mins.
	190°C	25-30mins. per 500g + 25-30mins.
Stuffed and rolled - Add approx. 10 mins. per 500g to above cooking times or cook at 200°C for 20mins. then 160°C for remainder.		
<b>THOROUGHLY THAW FROZEN JOINTS AND POULTRY BEFORE COOKING.</b>		
<b>POULTRY</b>		
Chicken	150°C	20-25mins. per 500g + 20-25mins.
	190°C	15-20mins. per 500g + 15-20mins.
Turkey	150°C	20-25mins. per 500g + 20-25mins.
	190°C	15-20mins. per 500g + 15-20mins.
Stuffed Poultry - Cook at 200°C or at 200°C for 20mins. then 160°C for remainder. Prepacked (fresh or frozen) follow packers cooking times		
<b>CASSEROLE</b>	140°C	2-4hrs according to recipe
<b>YORKSHIRE PUDDING</b>	200°C	Large tin 30-35mins. Individual 10-20mins.
<b>CAKES</b>		
Very Rich Fruit	140°C	45-50mins. per 500g mixture
Rich fruit (180mm)	145°C	2½-3hrs.
Madeira (180mm)	150°C	80-90mins.
Queen Cakes	170°C	15-25mins.
Scones	190°C	10-15mins.
Victoria Sandwich	170°C	20-30mins.
<b>PASTRY</b>		
Plate Tart	190°C	45-50mins. Interchange after 25mins.
Fruit Pie	190°C	35-40mins.
Tartlets	190°C	15-20mins. according to size.
Puff Pastry	200°C	20-40mins. according to size.
<b>BREAD</b>	200°C	20-30mins.
<b>MERINGUES</b>	100°C	2-2½hrs
<b>PUDDINGS</b>		
Baked Egg Custard	150°C	45mins.-1hr.
Baked sponge pudding	180°C	40-45mins.
Milk pudding	150°C	2-3hrs.

500g is approximately 1lb (1lb 2oz)

# Cleaning your cooker

## Essential information

Before thorough cleaning isolate the electricity supply. Remember to switch on the electricity supply before use.

*Never use paint solvents, washing soda, caustic cleaners, biological powders, bleach, chlorine based bleach cleaners, coarse abrasives or salt. Don't mix different cleaning products - they may react together with hazardous results. Recommended cleaning materials are shown in the table at the end of this section.*

If you want to move your cooker for cleaning, see the section called 'Moving your cooker'.

All parts of the cooker can be cleaned with hot soapy water - **but take care that no surplus water seeps into the appliance.**

For cleaning materials see the 'Cleaning Table' at the end of this section.

## Grill

The grill pan and grid should be washed in hot soapy water. After grilling meats or any foods that soil, leave to soak for a few minutes in the sink immediately after use. Stubborn particles may be removed from the grid by using a nylon brush.

## Hob

It's very easy to clean the Hob with a recommended cleaner.

**CAUTION** — Do not use abrasive cleaners or pads, oven aerosols or pads or stain removers on the surface.

## Daily care

First of all, be sure that all heat indicator lights are off and the cooking surface is cool. Apply a small dab, about the size of a 10p piece, of ceramic cooking cleaning cream in the centre of each area to be cleaned. Dampen a clean paper towel and work the cleaning cream on the cooking surface as if you were cleaning a window. As a final step, wipe the cooking surface with a clean, dry paper towel.

## Cleaning for spills

For spills and boil-overs that occur while cooking, turn the unit off and wipe the area surrounding the hot zone with a clean paper towel. If a spill (other than a sugary substance) is on the hot zone, do not clean until the unit is completely cooled down and follow the instructions below ("Cleaning for burned-on spills"). If you accidentally melt anything

on the cooking or if you spill foods with a high sugar content (preserves, tomato sauce, etc.), REMOVE the spill IMMEDIATELY with a razor scraper, while the unit is still hot. IMPORTANT: Use an oven glove to protect your hand from potential burns. Scrape the major spill or melted material from the cooking zone and push into a cold area. Then, turn the unit "OFF" and allow to cool before cleaning further. After the cooking surface cools down and the heat indicator lights go off, use the daily care procedure as outlined above.

## Cleaning for burned-on spills

Be sure that the heat indicator lights are off and the hob is cool. Remove excess burned-on substance with a single-edged razor scraper. Hold the scraper at approximately a 30° angle to the surface and scrape off the burned-on matter as you would scrape paint off of a window.

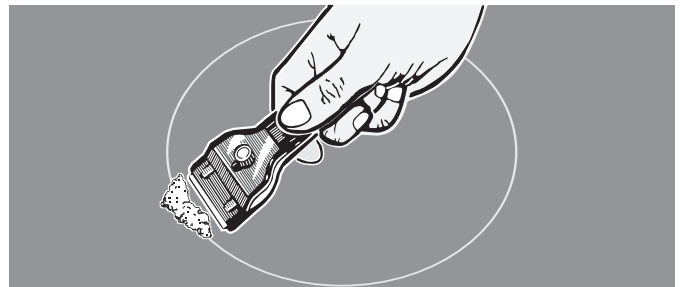

IMPORTANT: Take care when using a sharp scraper. When you have removed as much as possible with the scraper clean using the daily care procedure as described above.

## To remove metal rub-off

Sliding pans on the hob - especially aluminium or copper pans can leave marks on the surface. These marks often appear like scratches, but can be easily removed using the procedure described above for cleaning spills. If the rub-off marks are especially stubborn, use the cleaning cream together with the razor scraper, using the technique described above.

## Control Panel and Doors

The control panel and control knobs should only be cleaned with a soft cloth wrung out in clean hot soapy water - **but take care that no surplus water seeps into the appliance.** Wipe with a clean dampened cloth then polish with a dry cloth. The oven doors should only be cleaned with a soft cloth wrung out in clean hot soapy water.

## Cookers with window doors

On some models the oven door front panel can be taken off so that the glass panels can be cleaned. If the top edge of the oven door of your cooker has a

line of holes and there are screws in the side edges then it can be taken apart for cleaning.

Move the cooker forward to gain access to the sides (see the 'Moving the cooker' section of these instructions).

Open the oven door slightly and remove the front panel fixing screws from the door sides (two each side).

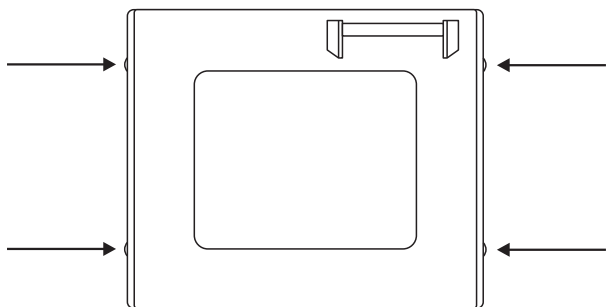

*some window doors only*

Carefully lift off the outer door panel. The inside face of the glass panels can now be cleaned - take care not to disturb or wet the door insulation. Please note that the door is triple glazed but the inner two panels are fixed and should not be separated. After cleaning carefully refit the outer door panel and replace the side fixing screws.

### The Main Oven

The Main oven has panels which have been coated with a special enamel that partly cleans itself. This does not stop all marks on the lining, but helps to reduce the amount of manual cleaning needed.

*The Cook & Clean panels work better above 200°C. If you do most of your cooking below this temperature, occasionally remove the panels and wipe with a lint free cloth and hot soapy water.*

*The panels should then be dried and replaced and the oven heated at 200°C for about one hour. This will ensure the Cook & Clean panels are working effectively.*

Don't use steel wool (Brillo) or any other materials that will scratch the surface. Don't use oven cleaning pads.

### Removing the Main Oven Linings

Some of the lining panels can be removed for cleaning and for cleaning behind. Remove the shelves first.

On some models the Main oven has a removable oven roof - if fitted slide the roof liner forward and remove.

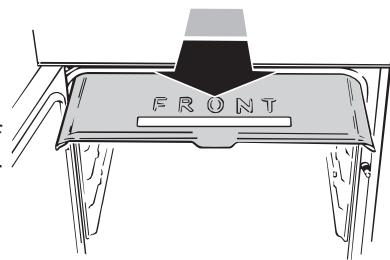

The side panels of the main oven can be removed.

### The Tall Oven

To clean the oven sides slide out the shelves, unhook the supports from the oven sides and lift out.

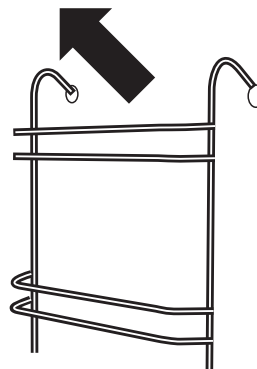

## Moving your cooker

Switch off the electricity supply.

*The cooker is heavy, two people may be required to move it. There are two levelling rollers at the back and also two screw down levelling feet at the front.*

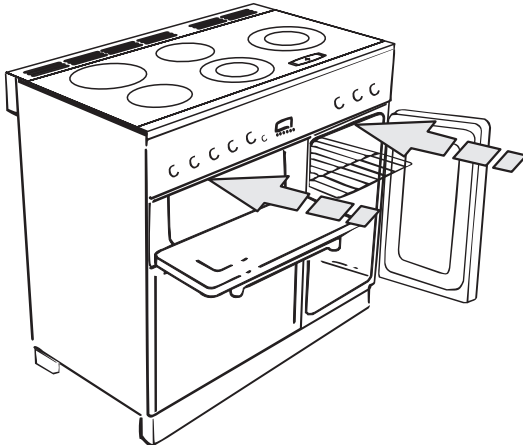

*Note - For illustration purposes, the Dual Fuel model is shown.*

Open the grill door and right hand oven door so that you can get a good grip on the bottom of the fascia panel as you move the oven.

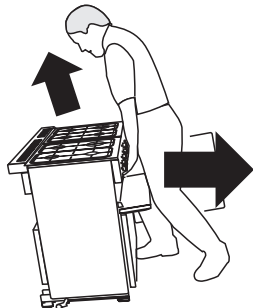

Lift the front of the cooker slightly and pull forward.

*Do not move the oven by pulling the door handles or knobs.*

Move the oven a bit at a time, checking behind it to make sure the gas hose is not caught. Make sure both electricity cable and gas hose have sufficient slack to move the cooker forward as you go along.

*If a stability chain is fitted, release it as you ease the cooker out. Don't forget to refit it when you replace the cooker.*

When you replace the cooker, again check behind to make sure that the electricity cable and gas hose are not caught or trapped.

## Troubleshooting

### **A crack has appeared in the Hob surface**

Disconnect the cooker immediately from the power supply and arrange for its repair. Don't use the cooker until after the repair. See the Customer care leaflet for how to contact a service person.

### **My Hob is scratched**

Have you used the correct cleaning methods?

Pots and pans with rough bottoms, or coarse particles (salt or sand) between the pan and the surface of the hob may cause scratches.

Use the recommended cleaning methods. Make sure pan bottoms are smooth and clean. Tiny scratches are not removable but will become less visible in time as a result of cleaning.

### **Metal markings on the Hob**

Do not slide aluminium or copper pans across the surface. Marks from aluminium and copper pans as well as mineral deposits from water or food can be removed with the cleaning cream.

### **Steam is coming from the oven**

When cooking foods with a high water content (e.g. oven chips) there may be some steam visible at the rear grille. Take care when opening the oven door, as there may be a momentary puff of steam when the oven door is opened. Stand well back and allow any steam to disperse.

### **The oven fan is noisy**

The note of the oven fan may change as the oven heats up - this is perfectly normal.

### **What cleaning materials are recommended for the cooker?**

See the 'Cleaning' section for recommended cleaning materials. We do not recommend Mr. Muscle, as it contains chemicals that may damage the surfaces of your cooker.

### **Grill not cooking properly**

Are you using the pan and trivet supplied with the cooker? Is the pan being used on the runners, not the floor of the compartment? Is the grill tray pushed fully back to stop?

### **The knobs get hot when I use the oven or the grill, can I avoid this?**

Yes, this is caused by heat rising from the oven or the grill, and heating them up. Don't leave the oven door open. Make sure that the grill pan is pushed right back to the 'back stop' when grilling.



### **If there is an installation problem and I don't get my original installer to come back to fix it who pays?**

You do. Service organisations will charge for their call-outs if they are correcting work carried out by your original installer. It's in your interest to track down your original installer.

### **Power failure**

In the event of a failure in the electrical supply the hotplate may be lit using a match.

### **Food is cooking too slowly, too quickly, or burning**

Cooking times may differ from your previous oven. Check that you are using the recommended temperatures and shelf positions. See the oven cooking guide. The oven control settings and cooking times are intended to be used only as a guide. Individual tastes may require the temperature to be altered either way, to get the results you want. Try cooking at a different temperature setting.

### **The oven is not cooking evenly**

Do not use a tin or baking tray larger than 340mm x 340mm in the Main oven or 232mm x 321mm in the Tall oven.

If you are cooking a large item, be prepared to turn it round during cooking.

If two shelves are used, check that space has been left for the heat to circulate. When a baking tray is put into the oven, make sure it is placed centrally on the shelf.

Check that the door seal is not damaged and that the door catch is adjusted so that the door is held firmly against the seal.

A dish of water when placed on the shelf should be the same depth all over. (For example, if it is deeper at the back, then the back of the cooker should be raised up or the front lowered). If the cooker is not level arrange for your supplier to level it for you.

### **The left hand Main oven not coming on when turned on manually**

Is the power on? Is the clock illuminated?

If not there may be something wrong with the power supply. Is the cooker supply on at the isolator switch?

Has the time of day been set?

Is the key symbol (Ⓚ) showing in the display? See the Clock section of the instructions for more information on the key lock feature of the clock.

### **The left hand Main oven not coming on when automatic cooking**

Timer set correctly but oven knob left OFF by mistake?

Is the key symbol (Ⓚ) showing in the display? See the Clock section of the instructions for more information on the key lock feature of the clock.

### **Oven temperature getting hotter as the cooker gets older**

If turning the knob down has not worked or only worked for a short time then you may need a new thermostat. This should be fitted by a service person.

### **The oven light is not working**

The bulb has probably blown. You can buy a replacement bulb (which is not covered under the guarantee) from a good electrical shop. Ask for an Edison screw fitting 15w 240v lamp, FOR OVENS. It must be a special bulb, heat resistant to 300 °C. See the HELP leaflet for spares by mail order.

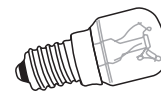

Turn off the power supply.

Make sure the oven is cool. Open the oven door and remove the oven shelves.

Unscrew the bulb cover by turning anticlockwise. It may be very stiff.

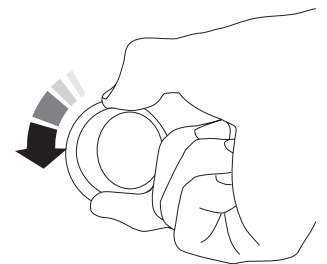
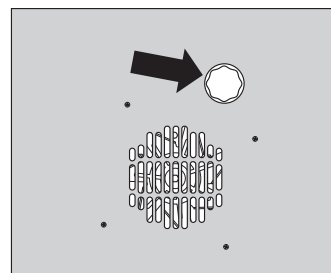

Taking care to protect your fingers in case the bulb should shatter, unscrew the old bulb.

Screw in the new bulb, screw back the bulb cover. Turn on the electricity supply and check that the bulb now lights.

## Cleaning Table

### Outside of cooker

Part	Finish	Recommended Cleaning Method
Door, Door surround.	Enamel or paint	Hot soapy water, soft cloth. Any stubborn stains, remove gently with a liquid detergent.
	Stainless Steel	E Cloth (Comet) or Vileda Microfibre Plus All Purpose Cloth <i>Freudenberg Household Products LP</i> (supermarket)
Sides and Plinth	Painted surface	Hot soapy water, soft cloth
Splashback/Rear Grille	Enamel or Stainless Steel	Hot soapy water, soft cloth. Cream cleaner, with care, if necessary.
Control panel	Paint, Enamel or Stainless Steel	Warm soapy water. Do not use abrasive cleaners on lettering.
Control Knobs/Handles	Plastic/ Chrome	Warm soapy water, soft cloth.
Oven Door Glass/Glass Lid (some models only)	Toughened glass	Hot soapy water, cream cleaner/scourer if necessary.

### Ovens

Part	Finish	Recommended Cleaning Method
Sides, floor & roof of oven - <b>NOT COOK &amp; CLEAN OVEN PANELS</b> (see below)	Enamel	Any proprietary oven cleaner that is suitable for enamel. CAUTION: CORROSIVE/CAUSTIC OVEN CLEANERS - FOLLOW MANUFACTURERS INSTRUCTIONS. Do not allow contact with the oven elements.
Cook & Clean Oven Panels (some models only)	Special enamel that partly cleans itself	This surface cleans itself at 200°C and above, or the panels can be removed and washed with hot soapy water and a nylon brush. (see 'The Ovens' in 'Cleaning your cooker')
Oven Shelves, Handyrack, Grill Trivet, Handygrill rack	Chrome	An oven interior cleaner that is suitable for chrome. Soap filled pad. Dishwasher.
Grill Pan/Meat Tin, Handygrill Pan (some models only)	Enamel	Hot soapy water. Soap filled pad (Brillo). Dishwasher.

Cleaners listed are available from Supermarkets or electrical retailers as stated. Cleaner manufacturer in Italics

For enamelled surfaces use a cleaner that is approved for use on vitreous enamel. The vitreous enamel association has a list of approved cleaners. Contact them via their website [www.ive.org.uk](http://www.ive.org.uk).

Regular cleaning is recommended. For easier cleaning, wipe up any spillages immediately.

To help keep your oven clean, cover meat when roasting, with foil or use a roasting bag. Brush vegetables with fat before placing around the meat.

# General Safety Instructions

---

The cooker must be installed by a qualified electrician in accordance with the installation instructions. It should be serviced by a qualified service engineer and only approved spare parts used. Have the installer show you the location of the cooker control switch. Mark it for easy reference. Always allow the cooker to cool and then switch off at the mains and before cleaning or carrying out any maintenance work, unless specified otherwise in this guide.

*All parts of the cooker become hot with use and will retain heat even after you have stopped cooking.*

Take care when touching the hob especially the marked cooking areas. The glass surface of the hob will retain heat after the controls have been turned off. To minimize the possibility of burns, always be certain that the hob controls are in the OFF position and that the entire glass surface is cool before attempting to clean the hob.

*Use dry oven gloves when applicable - using damp gloves might result in steam burns when you touch a hot surface. Never operate the cooker with wet hands.*

Do not use a towel or other bulky cloth in place of a glove. They might catch fire if they touch a hot surface.

*Always turn the surface unit controls off before removing the pans.*

Don't place utensils on the hob surface when it is in use. They may become hot and could cause burns.

*Clean the hob with caution. If a wet sponge or cloth is used to wipe spills on a hot surface unit, be careful to avoid steam burns. Some cleansers can produce noxious fumes if applied to a hot surface.*

Do not use unstable saucepans and position the handles away from the edge of the hotplate.

*Babies, toddlers and young children should not be allowed near the cooker at any time. They should never be allowed to sit or stand on any part of the appliance. Teach them not to play with controls or any other part of the cooker.*

Never store anything of interest to children in cabinets above a cooker - children climbing on the cooker to reach them could be seriously injured.

*Clean only parts listed in this guide.*

In the interests of hygiene and safety the cooker should be kept clean at all times as a build up in fats and other food stuff could result in a fire.

*We recommend that you avoid wiping any surface unit areas until they have cooled and the indicator light has gone off. Sugar spills are the exception to this. Please see 'Cleaning your cooker'. When the hob is cool, use only the recommended cleaning cream to clean the hob.*

To avoid possible damage to the cooking surface, do not apply the cleaning cream to the glass surface when it is hot. Read and follow all instructions and warnings on the cleaning cream labels. After cleaning, use a dry cloth or paper towel to remove any cleaning cream residue.

*Avoid heating an empty pan. Doing so may damage the hob and the pan.*

Always keep combustible wall coverings or curtains etc. a safe distance away from your cooker.

*Do not place or store items on top of the glass hob surface when it is not in use.*

Do not spray aerosols in the vicinity of the cooker while it is in on.

*Do not store or use combustible materials, or flammable liquids in the vicinity of this appliance.*

Do not use water on grease fires. Never pick up a flaming pan. Turn the controls off. Smother a flaming pan on a surface unit by covering the pan completely with a well fitting lid or baking tray. If available use a multipurpose dry chemical or foam-type fire extinguisher.

*Never leave the hob unattended at high heat settings. Pans boiling over can cause smoking and greasy spills may catch on fire.*

Never wear loose-fitting or hanging clothes while using the appliance. Be careful when reaching for items stored in cabinets over the hob. Flammable material could be ignited if brought in contact with a hot surface unit and may cause severe burns.

*Take great care when heating fats and oils, as they will ignite if they get too hot.*

Use a deep fat thermometer whenever possible to prevent overheating fat beyond the smoking point.

*Never leave a chip pan unattended. Always heat fat slowly, and watch as it heats. Deep fry pans should be only one third full of fat. Filling the pan too full of fat can cause spill over when food is added. If you use a combination of oils or fats in frying, stir them together before heating, or as the fats melt.*

Foods for frying should be as dry as possible. Frost on frozen foods or moisture on fresh foods can cause hot fat to bubble up and over the sides of the pan. Carefully watch for spills or overheating of foods when frying at high or medium high temperatures. Never try to move a pan of hot fat, especially a deep fat fryer. Wait until the fat is cool.

*When the grill is on, do not use the top of the flue (the slot along the back of the cooker) for warming plates, dishes, drying tea towels or softening butter.*

When using an electrical appliance near the hob, be sure that the cord of the appliance does not come into contact with the surface area.

*If you find a crack in the hob surface immediately disconnect the appliance from the supply and arrange for its repair.*

Take care that no water seeps into the appliance

*Only certain types of glass, glass-ceramic, earthenware or other glazed containers are suitable for hob cooking; others may break because of the sudden change in temperature.*

Use proper pan size-select pans having flat bottoms large enough to cover the surface unit's heating area. The use of undersized pans will expose a portion of the surface unit to direct contact and may result in ignition of clothing. Proper relationship of pans to surface unit will also improve efficiency.

*Do not allow anyone to climb, stand or hang on any part of the cooker.*

Do not use aluminium foil to cover shelves, linings or the oven roof.

*Make sure that your kitchen is well ventilated at all times. Use extractor fans or hoods when fitted.*

Never heat unopened food containers. Pressure build up may make container burst and cause injury.

*The cooker is designed for cooking foods only and must not be used for any other purpose.*

The oven should NOT be used for heating the kitchen, not only does this waste fuel but the control knobs may become overheated.

*When the oven is on DO NOT leave the oven door open for longer than necessary.*

The specification of this cooker should not be altered.

*This appliance is heavy, take care when moving it.*

When the cooker is not in use ensure that the control knobs are in the off position.

*Do not slide pans across the hob because this can scratch the glass - the glass is scratch resistant, not*

*scratch proof. Sharp instruments, rings or other jewellery and rivets on clothing could scratch the hob surface.*

Do not use the surface as a cutting board.

*Don't store heavy items above the hob. If they drop on the hob, they could cause damage*

# Installation

## Dear Installer

Before you start your installation, please complete the details BELOW.

If your customer has a problem relating to your installation they will be able to contact you easily.

Thank you

---

*Installer's Name*

---

*Installer's Company*

---

*Installer's Telephone number*

## Regulations

**This appliance must be installed by a qualified electrician to comply with the relevant regulations and also the local electricity supply company requirements.**

**You will need the following equipment to complete the cooker installation satisfactorily**

- ▶ **Multimeter (for electrical checks)**
- ▶ **Cooker levelling tool (provided in pack)**

### **You will also need the following tools:**

1. Electric drill
2. Masonry drill bit (only required if fitting the cooker on a stone or concrete floor)
3. Rawlplugs (only required if fitting the cooker on a stone or concrete floor)
4. Steel tape measure
5. Cross head screwdriver
6. Flat head screwdriver
7. Spirit level
8. Pencil
9. Adjustable spanner
10. Screws for fitting stability bracket

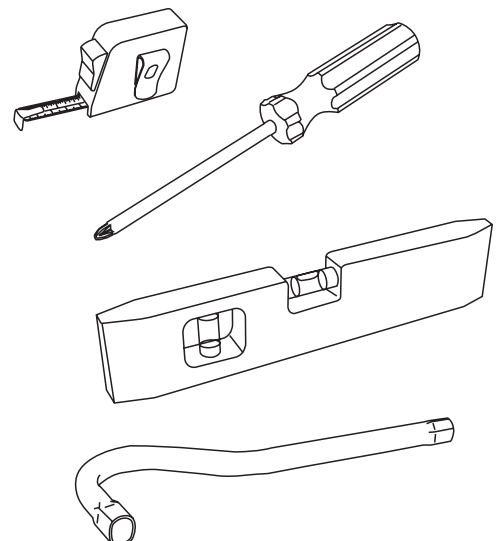
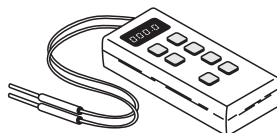

## Positioning the Cooker

The diagrams below show the minimum recommended distance from the cooker to nearby surfaces.

The cooker should not be placed on a base.

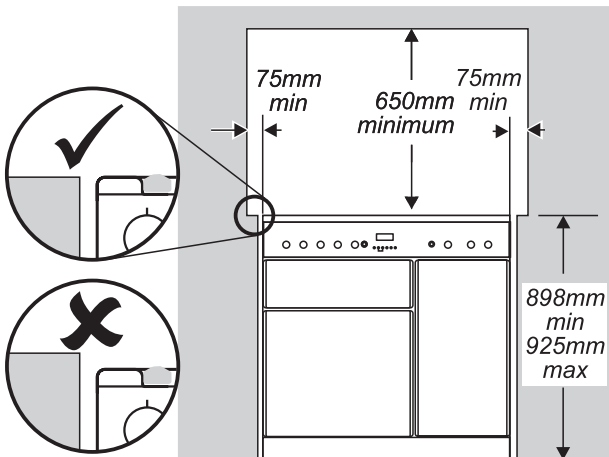

The hotplate surround should be level with, or above, any adjacent work surface. Above hotplate level a gap of 75mm should be left between each side of the cooker and any adjacent vertical surface.

For non-combustible surfaces (such as unpainted metal or ceramic tiles) this can be reduced to 25mm.

A minimum space of 650mm is required between the top of the hotplate and a horizontal combustible surface.

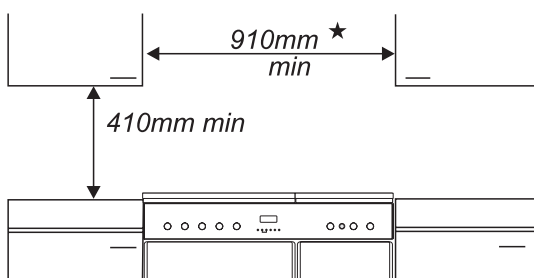

\*Any cooker hood should be installed in accordance with the hood manufacturer's instructions.

Surfaces of furniture and walls at the sides and rear of the appliance should be heat, splash and steam resistant. Certain types of vinyl or laminate kitchen furniture are particularly prone to heat damage and discolouration. We cannot accept responsibility for damage caused by normal use of the cooker to any material that delaminates or discolours at temperatures less than 65°C above room temperature.

For safety reasons curtains must not be fitted immediately behind the cooker.

We recommend a gap of 910mm between units to allow for moving the cooker. Do not box the cooker in; it must be possible to move the cooker in and out for cleaning and servicing.

A clearance of 130mm is required if the cooker is near a corner of the kitchen to allow the oven doors to open. The actual opening of the doors is slightly less but this

allows for some protection of your hand as you open the door.

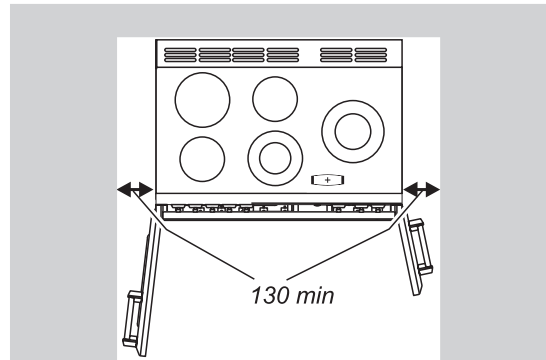

## Unpacking the Cooker

Do not take any packaging off the cooker until it is directly in front of the place it is to be installed (unless it will not fit through a door in its outer packaging).

Cut the banding straps and lift the cardboard box off the cooker, leaving the cooker standing on the base packaging. See the loose unpacking sheet.

## Checking the parts

<p>Levelling tool and Allen keys</p>	<p>1 flat oven shelf and 1 drop shelf</p>
<p>Tall oven shelves &amp; shelf supports</p>	<p>Handyrack</p>
<p>Meat tin</p>	<p>Grill pan and trivet</p>
<p>Inner and outer plinths</p>	

## Moving the Cooker

The cooker is very heavy. Take great care.

We recommend two people manoeuvre the cooker.

Ensure that the floor covering is firmly fixed, or removed to prevent it being disturbed when moving the cooker around. You will need the levelling tool.

Remove the polystyrene base pack. From the front tilt the cooker forward and remove the front half of the polystyrene base.

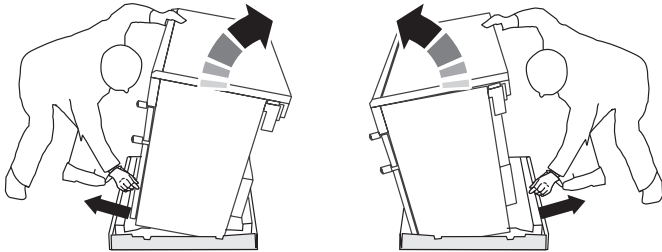

Repeat from the back and remove the rear half of the poly base.

**LOWER THE TWO REAR ROLLERS.**

First fit the levelling tool on the hexagonal adjusting nut as shown below.

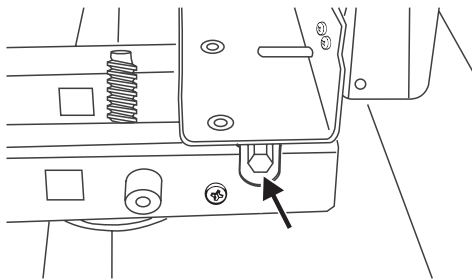

Make 10 complete (360°) turns clockwise. (This means turning and removing the levelling tool 20 times).

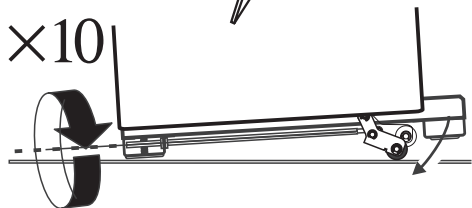
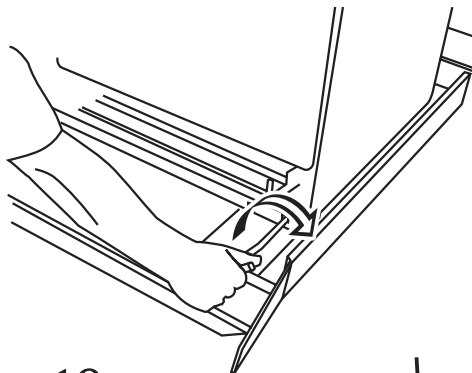

Make sure you lower **BOTH REAR ROLLERS**. There are two adjusting nuts, one for each roller, at both the front bottom corners of the cooker.

Unfold the rear edge of pack base tray. Open the grill door and the Tall oven door. Grip under the fascia panel and lift the front of the cooker.

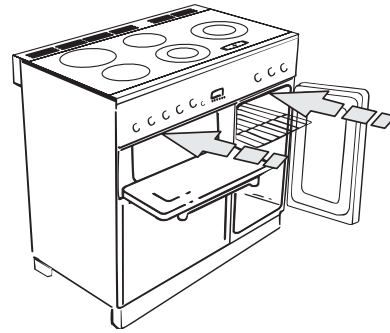

Carefully push the cooker backwards off the pack base. Remove the pack base tray. Position the cooker close to its final position leaving just enough space to get behind it.

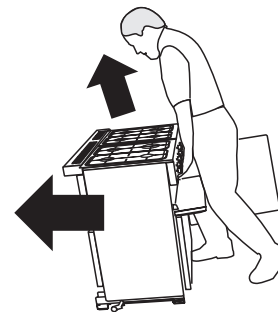

Do not use the door handles or control knobs to manoeuvre the cooker. Use the hotplate and griddle bowl areas.

## Levelling

You are recommended to use a spirit level on a shelf in one of the ovens to check for level.

Place the cooker in its intended position taking care not to twist it within the gap between the kitchen units as damage may occur to the cooker or the units.

The front feet and rear rollers can be adjusted to level the cooker. To adjust the height of the rear of the cooker use the levelling tool supplied to turn the adjusting nuts at the front bottom corners of the cooker. To set the front feet turn the bases to raise or lower.

## Fitting a stability bracket

A stability bracket or chain (not supplied by with the cooker) should be fitted when the cooker is connected to a flexible gas supply.

When fitting a stability bracket read these instructions together with the leaflet supplied with the bracket.

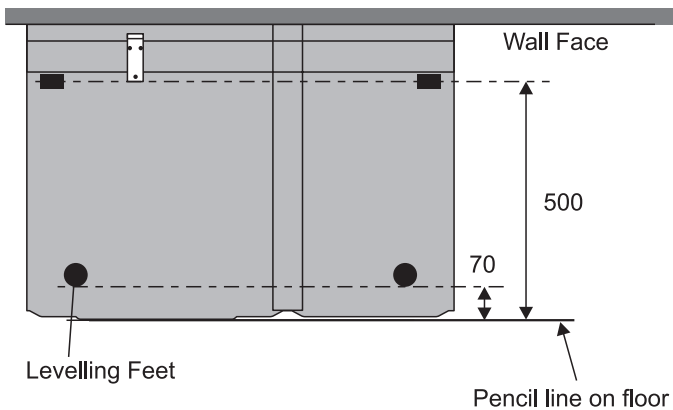

1. Place the cooker in its intended position and level the cooker.
2. Draw a pencil line 70mm from the front edge of the levelling feet.
3. Mark the centre line for the bracket by measuring 550mm from the left hand side of the cooker.
4. Move the cooker forward.
5. Measure back from the pencil line 500mm to locate the front edge of the bracket. Position the bracket so that it is away from centreline of the cooker to reduce the possibility that it will trap the electrical connection cable. Fix the bracket to the floor.
6. Measure the height from floor level to engagement edge in back of cooker. Add 3mm to this dimension and assemble the stability bracket to this height. (i.e. from floor level to underside of the top member) and ensure the bracket does not foul the oven burner assembly.

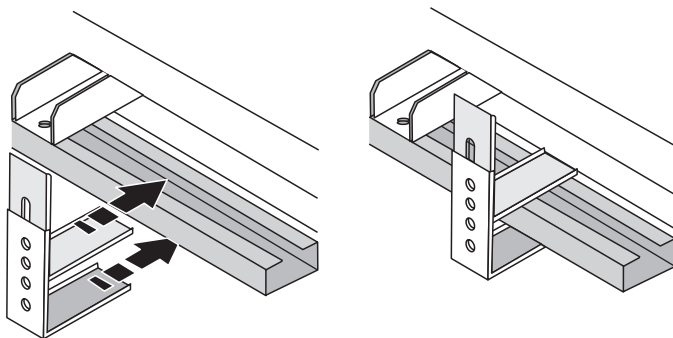

## Electrical Connection

This appliance must be installed by a qualified electrician to comply with the relevant Institute of Electrical Engineers (I.E.E.) regulations and also the local electricity supply company requirements.

**WARNING: THIS APPLIANCE MUST BE EARTHED**

### Note

The cooker must be connected to the correct electrical supply as stated on the voltage label on the cooker, through a suitable cooker control unit incorporating a double pole switch having a contact separation of at least 3mm in all poles. This cooker must not be connected to an ordinary domestic power point.

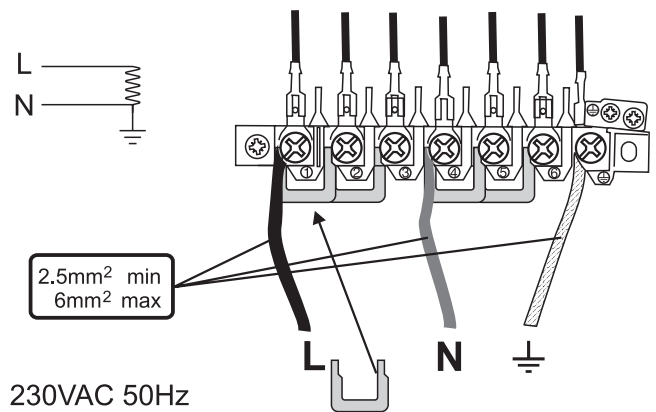

230VAC 50Hz

Access to the mains terminal is gained by removing the electrical terminal cover box on the back panel. Connect the mains cable to the correct terminals for your electrical supply type (see fig.). Check that the links are correctly fitted and that the terminal screws are tight. Secure the mains cable using the cable clamp.

These appliances are of type X with regard to protection against over heating of the surrounding surfaces.

## Hotplate

Check each burner in turn. Push in tap and turn to the large flame symbol. Press ignition switch on facia panel..

## Oven check

The clock must be set to the time of day before the left hand Main oven will work.

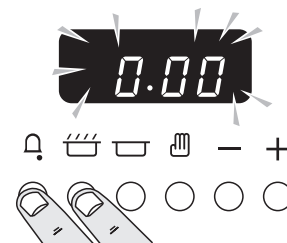

Press and hold as above.

At the same time, press - or + until the correct time shows.

Don't forget it's a 24 hour clock.

If you make a mistake or press the wrong button, turn off the power supply for a minute or two and start again.

Turn on the ovens. Check that the oven fans start to turn and that the ovens start to heat up. Turn off the ovens.

## Fitting the plinth

Fit the inner plinth to the bottom front of the cooker using the 5 screws provided.

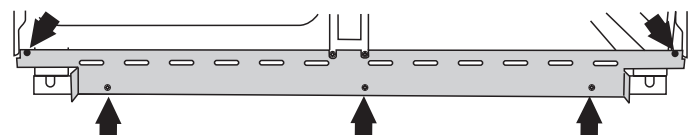

Fit the outer plinth (2 screws 1 each end) to the inner plinth. The height of the outer plinth can be adjusted by sliding it up or down via the slotted hole.



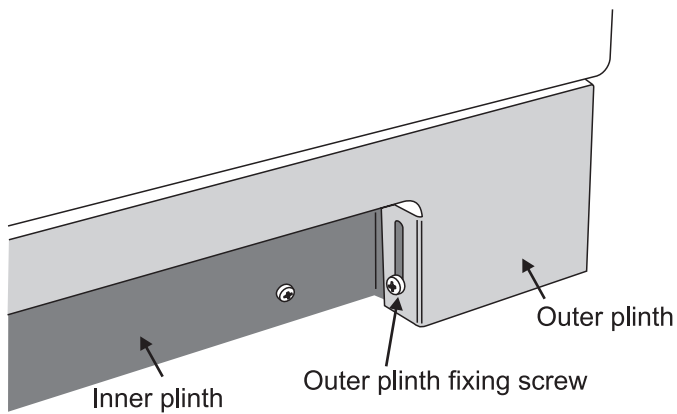

## Door adjustment

Please check the alignment of the doors. The left hand Main oven has adjustable hinges

### To Adjust the Oven Door Angle

The door bottom hinge can be adjusted to alter the angle of the door.

Loosen the bottom hinge fixing screws and use the notch and a flat bladed screwdriver to move the position of the hinge to set the hinge position.

Retighten the hinge screws.

*Effect of hinge adjustment – exaggerated for clarity*

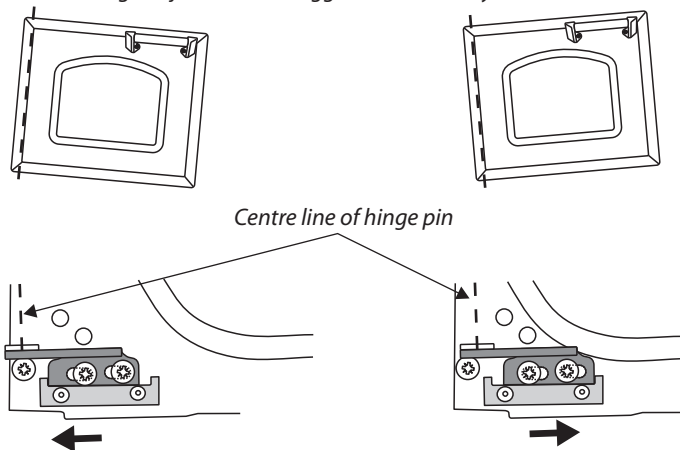

*Oven door omitted for clarity*

## Customer care

Please complete your contact details in the front of this section. Please inform the user how to operate the cooker and hand over the instruction pack.

**Thank you.**

## Servicing Notes

Disconnect from electricity supply before commencing servicing, particularly before removing any of the following: control panel, side panels, ceramic hob, or any of the electrical components or cover boxes. Before electrical reconnection check that the appliance is electrically safe.

### 1. To Remove a Side Panel

Disconnect from electricity supply.

Pull the cooker forward.

Pull off the push fit control panel end caps at each end and remove the end fixing screws under the end cap.

Remove the retaining screws for each panel (1 at the front and 2 at the rear). The lower front retaining screws (one each side) are situated beneath the lower edge at the front corners of the side panels

Reassemble in reverse order.

### 2. To Lift up the Ceramic Hob

Pull the cooker forward.

Unscrew the 2 screws which are located at the rear of either side of the cooker underneath the grill trim

Push the hob backwards to release the front catchment bracket.

Lift the hob.

Hold the hob in place using the rod attached to the underside of the hobplate, by locating the loose end into the central hole in the top of the inner control panel.

### Caution

**The ceramic hob material is much more sensitive to scratches on the underside than the top.**

Lift up the ceramic hob at the front and prop in position with a non-metallic prop.

**Take care not to touch or scratch the underside of the ceramic as this will weaken the material and cause the top to shatter.**

### 1. To Remove a Side Panel

### 3. To replace a hob element.

Lift up the ceramic hob see 2. The elements are now accessible.

### 4 To Remove the Control Panel

Disconnect from electricity supply.

Remove the handrail by removing the 2 end bracket fixing screws.



Pull off the push fit control panel end caps at each end and remove the end fixing screws under the end cap.

Pull off all the control knobs. Open the grill and oven doors and remove the control panel fixing screws underneath the control panel. The screws directly below the clock are for the clock fixing bracket - don't remove them at this stage.

Lift the control panel, pull forward and disconnect the wiring from the rear.

Reassemble in reverse order. When replacing leads refer to the wiring diagram. Check operation of timer.

### 5. To Remove Oven Light Switch

Remove control panel (see 4).

NB The old switch may be destroyed during removal.

Remove switch button and old switch from its bezel by gripping the switch body behind the control panel and twisting sharply.

The switch bezel can then be removed by folding back its locking wings and pushing forward. Fit the new bezel to the control panel by first lining up the raised key on its body with the cut-out in the control panel and pushing it in from the front. Assemble the new switch to the bezel by lining up the key sections and pushing home. Fit the new button by pushing in from the front.

Replace control panel in reverse order and test for correct operation.

### 6. To Remove Electronic Timer

Disconnect from electricity supply.

Pull off the timer control buttons and remove the control panel (See 4). Remove the timer/mounting bracket assembly from the control panel by removing the two fixing screws. Remove the timer from its mounting bracket by depressing the plastic lugs on the timer case, at the same time pulling the unit forward.

Reassemble in reverse order. When replacing leads refer to the wiring diagram. Check operation of timer.

### 7. To Remove a Thermostat

Lift up the ceramic hob top (see 2). Remove control panel (see 4). Open appropriate oven door and remove oven furniture.

### RH oven

Remove thermostat dial cover (2 screws). Unclip the thermostat dial from the clips in the oven back.

**WARNING - SERVICING TO BE CARRIED OUT ONLY BY AN AUTHORISED PERSON**  
**Disconnect from electricity before servicing. Check appliance is safe when you have finished.**

**LH oven**

Pull cooker forward to gain access to the cover box at the rear of the cooker. Remove the screws securing the cover and lift clear.

Feed the thermostat capillary out of the oven. Disconnect wiring from thermostat. Remove 2 screws holding thermostat to mounting panel. Fit new thermostat and reassemble in reverse order. Ensure that the phial is clipped to the oven back with the phial centrally positioned between the clips.

Check operation of thermostat.

**8. To Change Grill Controller**

Lift up the ceramic hob top (see 2). Remove control panel (see 4). Disconnect wiring from controller. Remove 2 screws holding controller to mounting panel. Fit new controller and reassemble in reverse order. Check for correct operation.

**9. To Remove Grill Door**

Remove the left hand side panel (see 1). Remove the control panel (see 4). Remove the centre cover strip (5 screws, 2 top, 2 bottom, 1 in middle). Remove the two countersunk screws (1 each side) securing the grill hinge arms to the front of the grill chamber.

NOTE: The arms are spring tensioned. Carefully remove the grill door. Retain the gaskets.

Reassemble in reverse order ensuring that the gasket is fitted between the hinge arm and the front of the grill chamber.

**10. To Remove Main Oven Door**

Open oven door and remove Handyrack (where fitted) by springing one side out of the bracket on the door and sliding the other side free. Support the door and remove the two screws securing the upper hinge and packing to the cooker front. Remove the door from the lower hinge by lifting slightly and moving outwards.

Reassemble in reverse order.

**11. To Change Main Oven Door Outer Panel**

Move the cooker forward to gain access to the sides.

Open the oven door slightly and remove the front panel fixing screws from the door sides (two each side).

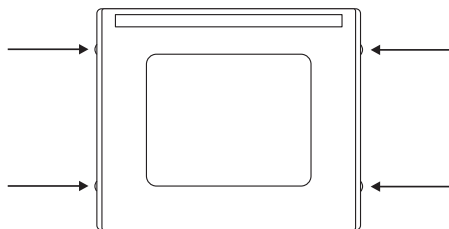

Carefully lift off the outer door panel.

Remove door handle from panel by unscrewing 2 retaining nuts. Fit door handle to new panel

Fit panel to door. Reassemble in reverse order.

**12. To Change Main Oven Door Latch**

Remove outer door panel (see 15). Remove screws 'B' holding latch assembly to inner door panel. Fit new catch and reassemble in reverse order.

Check correct door operation.

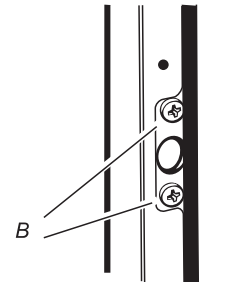

**13. To Change Oven Door Seal**

Open oven door. The seal is held in place by small hooks on the rear face. At the corner pull seal diagonally away from the door centre until that hook is released. Proceed to the next hook and release it in a similar way, and so on. Use force if the hooks are stiff, as the old seal will be discarded.

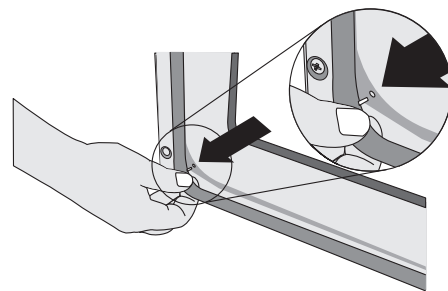

When fitting new seal, position the seal join at the bottom. Hook the new seal in one of the corner holes of the door, and proceed round the door snapping in each hook in turn.

**14. To Adjust Main Oven Door Catch Keep**

Open oven door, slacken off locknut at base of keep, and screw in or out as required until required fit is obtained. Retighten locking nu

**6. To Remove a Thermostat**

Disconnect from the electricity supply.

Remove control panel and hotplate (see 1 & 2). Open oven door. Remove oven furniture and slide out oven roof liner if fitted.

**Left hand oven**

Pull cooker forward to gain access to the cover box at the rear of the cooker. Remove the four screws securing the cover and lift clear. The oven thermostat capillary is clamped to the oven back sheet with an earthing plate. Remove the screws and plate.

**WARNING - SERVICING TO BE CARRIED OUT ONLY BY AN AUTHORISED PERSON**  
**Disconnect from electricity before servicing. Check appliance is safe when you have finished.**

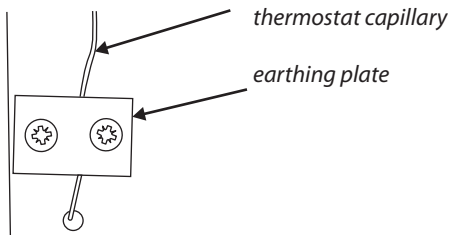

#### Right hand oven,

The oven thermostat capillary is clamped to the right hand rear upright with an earthing plate.

Remove thermostat phial cover (2 screws). Unclip the thermostat phial from the clips in the oven back.

Feed the thermostat capillary out of the oven.  
 Disconnect wiring from thermostat. Remove 2 screws holding thermostat to mounting panel. Fit new thermostat and reassemble in reverse order. Ensure that the phial is clipped to the oven back with the phial centrally positioned between the clips.  
 Remember to refit the earthing plate.  
 Check operation of thermostat.

#### 7. To Change Grill Controller

Disconnect from the electricity supply.

Remove the control panel and hotplate (see 1 & 2). Disconnect wiring from controller. Remove 2 screws holding controller to mounting panel. Fit new controller and reassemble in reverse order. Check for correct operation.

BEFORE SERVICING ANY GAS CARRYING COMPONENTS  
 TURN OFF GAS SUPPLY.

#### 8. To Change Hotplate Control Taps

Disconnect from the electricity supply.

Remove the control panel and hotplate (see 1 & 2). Undo compression fitting at the rear of the tap. Remove the fixings that secure the tap to the gas rail. Remove the tap. Remove and discard the gasket seal. Fit new gasket seal to replacement tap. Re-assemble in reverse order. Check the appliance is gas sound. Check hotplate ignition.

#### 9. To Change Hotplate Burner Injector

Remove burner cap and head. Remove old jet. Fit new injector. Reassemble in reverse order. Check appliance is gas sound.

#### 10. To Change Hotplate Burner Electrode

Lift off pan supports, remove burner cap. Remove the screw holding the electrode. Pull electrode vertically up sufficiently to grip the lead between thumb and forefinger. Pull off the electrode, but keep hold of the

lead. Fit new electrode to the lead. Fix electrode in burner with screw. Replace burner cap. Check the burner ignition. Replace pan supports.

#### 11. To Remove or Change a Hotplate Burner.

Remove the hotplate tray (see 2).

The burners except the right hand wok burner are mounted on support struts. For these burners, disconnect the burner feed pipes at the burner. Remove the screws at the front and rear holding the support struts. Lift the strut and burners clear. The burners are fixed to the support struts with 2 screws. Remove the appropriate burner and fit the new one. Reassemble in reverse order. Check burner operation is satisfactory.

#### RH Wok burner

Disconnect the burner feed pipes at the burner. Fit the new one and reassemble in reverse order. Check burner operation is satisfactory.

#### 12. To Remove an Oven Door

Open oven door and remove Handyrack (where fitted) by springing one side out of the bracket on the door and sliding the other side free.

Door is heavy - take care. Open the oven door. Loosen the two top hinge screws.

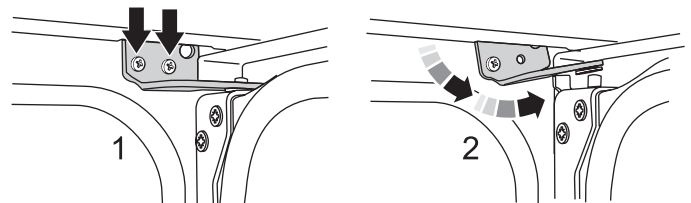

Support the weight of the door and remove the screw nearest the hinge pin. Swing the hinge up and away from the hinge pin on the door.

Lift the door away from the bottom hinge.

Re-assemble in reverse order.

When replacing the door ensure that the nylon hinge bush is in position between the hinge pin and the hinge bracket at the both the bottom and top.

#### 13. To Change Main Oven Door Outer Panel

Move the cooker forward to gain access to the sides.

Open the oven door slightly and remove the front panel fixing screws from the door sides (two each side).

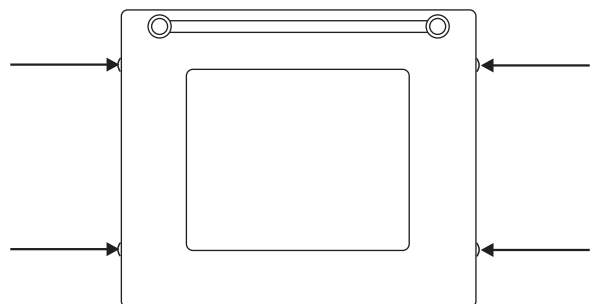

**WARNING - SERVICING TO BE CARRIED OUT ONLY BY AN AUTHORISED PERSON**  
**Disconnect from electricity before servicing. Check appliance is safe when you have finished.**

Carefully lift off the outer door panel.

Remove door handle from panel by unscrewing 2 retaining nuts. Fit door handle to new panel

Fit panel to door. Reassemble in reverse order.

#### 14. To Change the Main Oven Door Latch

Remove outer door panel (see 13).

Remove screws 'B' holding latch assembly to inner door panel.

Fit new catch and reassemble in reverse order.

Check correct door operation.

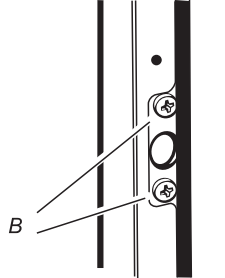

#### 15. To Adjust the Main Oven Door Catch Keep

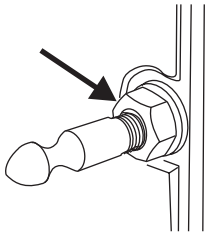

Open oven door, slacken off locknut at base of keep, and screw in or out as required until required fit is obtained.

Retighten locking nut.

#### 16. To Change Oven Door Seal

Open oven door. The seal is held in place by small hooks on the rear face. At the corner pull seal diagonally away from the door centre until that hook is released. Proceed to the next hook and release it in a similar way, and so on. Use force if the hooks are stiff, as the old seal will be discarded.

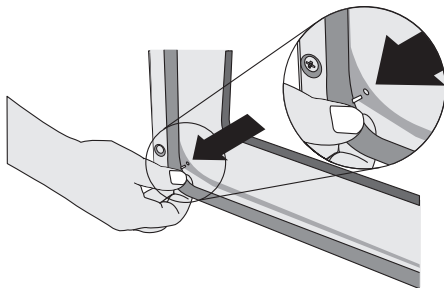

When fitting new seal, position the seal join at the bottom. Hook the new seal in one of the corner holes of the door, and proceed round the door snapping in each hook in turn.

#### 17. To Change Tall Oven Door Outer Panel

Remove oven door see 12. Lay door face down on a suitable surface and remove 2 screws from bottom edge of door and 2 screws from inside face of door.

Remove outer door panel. Remove door handle by unscrewing 2 screws. Remove 2 cross-headed screws holding door handle fixing bracket to door panel. Fit door handle bracket and door handle to new panel.

Fit panel to door. Reassemble in reverse order.

#### 18. To Change Tall Oven Door Magnetic Latch

Remove the control panel (see 1).

Remove the plinth (3 screws) and the central vertical cover (5 screws). Prise the retaining clip off the magnet unit. Fit new unit and retaining clip.

Reassemble in reverse order.

Check correct door operation.

#### 19. To Remove Grill Element.

Disconnect from electricity supply.

Remove grill pan from grill chamber. From inside grill compartment remove enamelled front shield from grill roof, 2 screws and washers. Remove 2 screws and washers securing the grill element front support. Remove the screws from the grill elements.

Lift elements out carefully, disconnect the leads from the element terminals noting their position. If it is not possible to disconnect the leads in this way, pull cooker forward to gain access to the rear, remove screws securing the electric cover to the back sheet and remove cover and disconnect the terminals from the rear.

Fit new elements, reassemble in reverse order. Check operation of grill.

#### 18. To Remove an Oven Inner Back.

Open the oven door and remove the screws and washers securing the inner back to the back of the oven.

Carefully lift away the inner back. Reassemble in reverse order making sure that the 4 screws and washers are fully tightened.

#### 19. To Change Fan in Oven.

Disconnect from electricity supply.

Pull cooker forward to gain access to the rear. Remove screws securing the electric cover to the back sheet and remove cover. Disconnect the 3 terminals connected to the fan noting their position. Remove oven inner back (see 18). Hold the fan blade and remove the centre nut (left hand thread) 2 brass washers, fan blade and Circlip. Unscrew fan retaining nuts and washers (3 off each) and lift the fan away from the rear of the cooker. Fit new fan and reassemble in reverse order. Check operation of oven.

#### 20 To Remove an Oven element Thermal Cut-Out.

Disconnect from the electricity supply.

Pull the cooker forward to gain access to the cover box. Undo the cover screws and lift clear. The cutout is located on the earth plate beside the oven element connections. Disconnect the cutout wiring. Undo the fixings that secure the cutout to the earth plate and remove. Fit replacement control and re-assemble in reverse order.

**WARNING - SERVICING TO BE CARRIED OUT ONLY BY AN AUTHORISED PERSON**  
Disconnect from electricity before servicing. Check appliance is safe when you have finished.

## 21. To Remove Oven Element.

Disconnect from electricity supply.

Remove oven inner back (see 18).

Remove 2 screws from the top of the element and 1 from the bottom of the element in side the oven. Lift element out carefully, disconnect the terminals connected to the element noting their positions.

If it is not possible to disconnect the leads in this way, pull cooker forward to gain access to the rear.

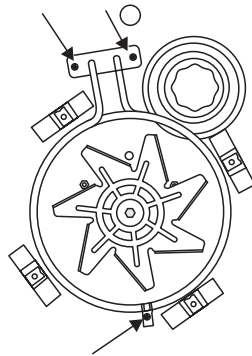

Remove screws securing the electric cover to the back sheet and remove cover and disconnect the terminals from the rear.

Fit new element, and reassemble in reverse order. Check operation of oven.

## 22. To change oven light bulb.

### LH Oven

Remove the oven furniture and side linings. Remove the oven rear liner.

### RH Oven

Remove the oven inner back (see 18). The oven light cover is now accessible. Unscrew the cover.

Unscrew the bulb.

Fit an Edison screw fitting 15w 240v lamp, FOR OVENS. It must be a special bulb, heat resistant to 300°C.

## 23 To Adjust the Oven Door Angle

The door bottom hinge can be adjusted to alter the angle of the door.

Loosen the bottom hinge fixing screws and use the notch and a flat bladed screwdriver to move the position of the hinge to set the hinge position.

Retighten the hinge screws.

*Effect of hinge adjustment – exaggerated for clarity*

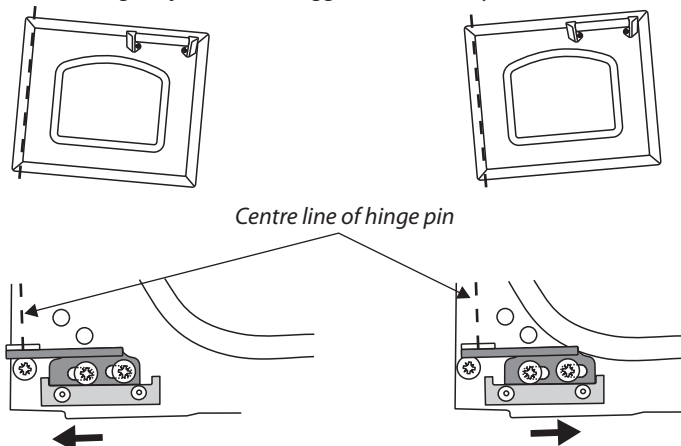

*Oven door omitted for clarityt*

# Technical Data

INSTALLER: Please leave these instructions with the User.

DATA BADGE LOCATION : Cooker back, serial number repeater badge below oven door opening.

Country of Destination: GB/IE

## Dimensions

<b>Overall height</b>	minimum 900mm	maximum 925mm
<b>Overall width</b>	900mm See 'Positioning of Cooker'	
<b>Overall depth</b>	648mm	
<b>Space for fixing</b>	See 'Positioning of Cooker'	
<b>Minimum space above hotplate</b>	650mm	

## Ratings

**Total Load** At 230V 50Hz 15.6kW (approximate total including oven lights, oven fan etc.)

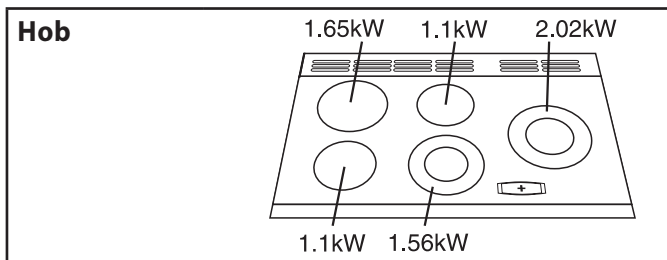

	Main Oven	Tall Oven
<b>Ovens</b>	<b>Forced air convection</b>	<b>Forced air convection</b>
	2.5kW	2.5kW
<b>Energy efficiency class</b> on a scale of A (more efficient) to G (less efficient)	A	B
<b>Energy consumption</b> based on standard load	0.85kWh	0.95kWh
<b>Usable volume</b> (litres)	67	53
<b>Size</b>	Large	Medium
<b>Time to cook standard load</b>	38 minutes	49 minutes
<b>Surface area of the grid</b>	1400cm <sup>2</sup>	790cm <sup>2</sup>

<b>Grill</b>	2.3kW
--------------	-------

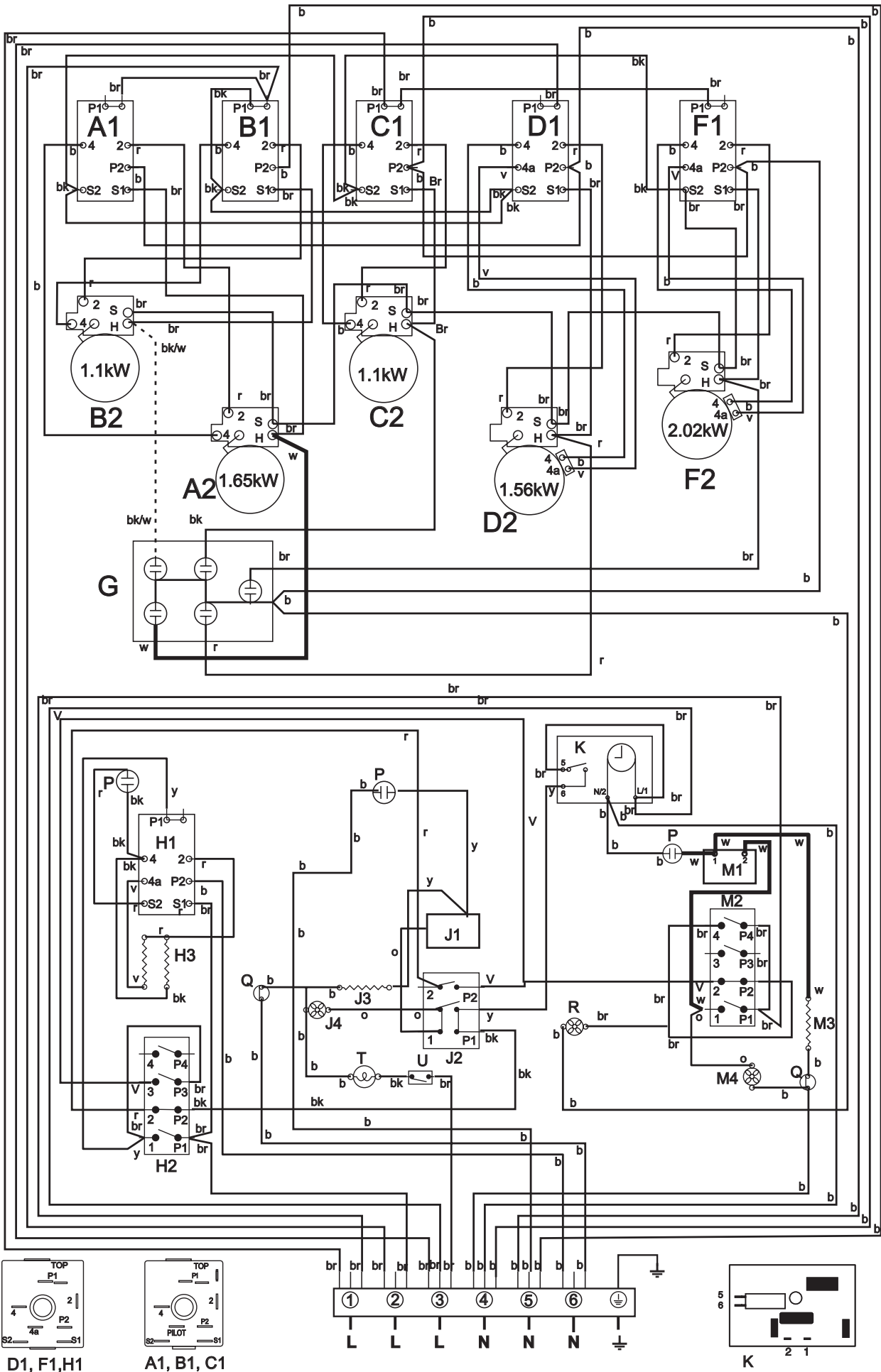



Connection shown in circuit diagram is for single phase.

Ratings are for 230V 50Hz

<b>Key to circuit diagram</b>	<b>Colour Code</b>
M1 Right hand oven thermostat M2 Right hand oven switch block M3 Right Fan oven element 2.5kW M4 Right hand oven fan J1 Left hand oven thermostat J2 Left hand oven switch block J3 Left Fan oven element 2.5kW J4 Left hand oven fan K Clock H1 Grill energy regulator H3 Right hand grill element 1.15kW H3 Left hand grill element 1.15Kw	E Earth L Live N Neutral O1 Main oven light switch O2 Main oven light P1 Ignition switch P2 Spark generator Q Neon R Cut-out  b Blue br Brown bk black or Orange r Red v Violet w White y Yellow g/y Green/Yellow





# RANGEmaster

Clarence Street, Royal Leamington Spa,  
Warwickshire, CV31 2AD, England.  
Tel: +44 (0) 1926 457400 Fax: +44 (0) 1926 450526  
E-mail: [consumers@rangemaster.co.uk](mailto:consumers@rangemaster.co.uk)  
[www.rangemaster.co.uk](http://www.rangemaster.co.uk)

**AGA FOODSERVICE GROUP**



271106

## Free Manuals Download Website

<http://myh66.com>

<http://usermanuals.us>

<http://www.somanuals.com>

<http://www.4manuals.cc>

<http://www.manual-lib.com>

<http://www.404manual.com>

<http://www.luxmanual.com>

<http://aubethermostatmanual.com>

Golf course search by state

<http://golfingnear.com>

Email search by domain

<http://emailbydomain.com>

Auto manuals search

<http://auto.somanuals.com>

TV manuals search

<http://tv.somanuals.com>