

# **Raymarine Satellite TV Systems**

## User's Guide

Document Number: 81258\_3

Date: October 2006

## **Trademarks and registered trademarks**

Autohelm, HSB, Raymarine, RayTech, Sail Pilot, SeaTalk and Sportpilot are registered trademarks of Raymarine Limited. Apelco is a registered trademark of Raymarine Holdings Limited (Registered in all major marketing territories).

AST, Autoadapt, Auto GST, Autoseastate, Autotrim, Bidata, Marine Intelligence, Maxiview, On Board, Raychart, Raynav, Raypilot, Raystar, ST40, ST60, Seaclutter, Smart Route, Tridata and Waypoint Navigation are trademarks of Raymarine Limited.

DIRECTV is an official trademark of DIRECTV Inc., a unit of GM Hughes Electronics.

DISH™ Network is an official trademark of EchoStar Communications Corporation.

ExpressVu is a property of Bell ExpressVu, a wholly owned subsidiary of Bell Satellite Services.

All other product names mentioned are trademarks or registered trademarks (if applicable) of their respective companies.

**© Raymarine plc 2006**

- Powered by Intellian Technologies -

## Contents

<b>Safety notices</b> .....	<b>1</b>	Twin IRDs .....	17
<b>Important information</b> .....	<b>3</b>	Multiple IRDs .....	18
Geographic location .....	3	System with 4 RF connector baseplate .....	21
Television reception .....	4	Multiple IRDs .....	22
EMC conformance .....	4	Connecting your satellite TV system to an NMEA0183 GPS .....	23
Declaration of conformity .....	4	<b>System set up</b> .....	<b>25</b>
Waste Electrical and Electronic Equipment Directive .....	4	Start up .....	25
Restriction of the use of certain Hazardous Substances .....	4	Changing the default satellite .....	26
Warranty .....	4	Monitoring the current status of the antenna .....	26
Handbook information .....	4	Set up mode .....	27
<b>Installation</b> .....	<b>7</b>	Setting the satellite pair .....	27
EMC installation guidelines .....	7	Setting the satellite pair - DirecTV .....	28
What's in the box? .....	8	Setting the GPS using the ACU .....	29
What tools do I need to install my TV system? .....	9	Edit satellite information .....	30
How do I plan the installation? .....	10	Setting the local frequency .....	32
Cables .....	10	LNB systems in regions with linear polarization .....	33
Power requirements .....	10	Setting the DiSEqC method .....	34
Extending the cables .....	11	Setting the LNB skew angle .....	35
How do I install the ACU? .....	12	Display version .....	36
ACU dimensions .....	12	Setting antenna go position .....	36
Installing the ACU .....	13	Setting antenna move step .....	37
How do I install the antenna? .....	14	Setting defaults .....	38
How do I connect the system cables? .....	15	GUI main menu .....	39
Connecting the antenna .....	15	Serial port set up .....	40
Connecting the ACU .....	16	The GUI control soft keys .....	40
How do I configure the system? .....	16	Setting the GPS .....	41
Systems with 2RF connector baseplate .....	16	Editing the satellite information .....	42
Single IRD .....	16	Setting antenna angle, move step and diagnosis. ....	43

---

<b>Maintenance and troubleshooting .....</b>	<b>45</b>
Introduction .....	45
Maintenance .....	45
Troubleshooting .....	45
Antenna diagnosis .....	47
Technical support .....	48
<b>Satellite information .....</b>	<b>49</b>
Introduction .....	49
Satellite coverage areas .....	49
Climatic conditions .....	49
European satellites .....	49
US satellites .....	53
Mexico .....	54
Australia .....	55
New Zealand .....	55
Far East .....	56
Middle East .....	57
South America .....	59
Satellite coverage by geographic location .....	60
Europe .....	60
Satellite tracking .....	62
Satellite service providers .....	62
European satellites .....	62
<b>Technical specification .....</b>	<b>67</b>
Raymarine 45 STV .....	67
Raymarine 60 STV .....	70

## Safety notices



### WARNING

#### Product installation

This equipment must be installed in accordance with the instructions contained in this handbook. Failure to do so could result in poor product performance, personal injury and/or damage to your boat.



### CAUTION

#### In-line fuse

If you do not have a breaker in the power circuit, an in-line 5 A quick blow fuse should be fitted to the positive (white) lead of the power cable.



### CAUTION

#### Antenna unit cover

To prevent damage to the antenna unit cover always use the base plate when lifting the unit.



### CAUTION

#### Connectors

Take care not to damage the exposed connectors below the base plate when moving the unit. DO NOT use these connectors to lift the unit.



### CAUTION

#### Transit packaging

Before installing or operating the unit, open the unit cover and remove the foam transit packaging inserts from the base unit.



### CAUTION

#### Antenna coating

Application of paint or other finishes to the antenna unit exterior may degrade performance beyond acceptable limits.



# Important information

## Introduction



This handbook contains an explanation of how to install, connect and maintain your Raymarine Satellite TV system.

This handbook covers the following models:

- 45STV Satellite TV system.
- 60STV Satellite TV system.

Your Raymarine Satellite

TV system provides uninterrupted television access to hundreds of TV channels in all types of weather conditions.

On the open sea or at the dock, the Raymarine Satellite TV system automatically identifies, acquires and tracks compatible signals from all digital video broadcast (DVB) satellites.

However, no machine can perform its intended function unless installed, operated and maintained properly. Please carefully read and follow the recommended procedures contained in this handbook.

**INTENDED USE - The intended application for Raymarine Satellite TV systems is for leisure marine boats and workboats not covered by IMO carriage regulations. THEY ARE NOT intended for installation and use in any other situation.**

## Geographic location

Your Raymarine Satellite TV system is programmed to receive signals from selected satellites in the following areas:

- North America
- South America
- Europe
- Australia
- New Zealand
- China
- Middle East

You cannot receive signals that have linear polarization on a system set up for circular polarized signals or circular polarized signals on a system that is set up for linear polarized signals. If your geographic location changes it will be necessary to change the antenna low noise block (LNB) for one appropriate to the area in which you are operating. You may also need to change your IRD(s) and TV receivers. For full details of changing your geographic area of operation refer to "Satellite coverage by geographic location" on page 60

## Television reception

For full functionality of your Raymarine Satellite TV system, it is necessary to subscribe to the relevant service(s) from the appropriate service provider(s). Full details of service providers can be found in "Satellite service providers" on page 62.

## EMC conformance

All Raymarine equipment and accessories are designed to the best industry standards for use in the leisure marine market.

The design and manufacture of Raymarine equipment and accessories conform to the appropriate Electromagnetic Compatibility (EMC) standards, but correct installation is required to ensure that performance is not compromised.

## Declaration of conformity



This product conforms with EU Directive 89/336/EC and is labelled with the CE conformity mark.

## Waste Electrical and Electronic Equipment Directive



The Waste Electrical and Electronic Equipment (WEEE) Directive requires the recycling of waste electrical and electronic equipment. Whilst the WEEE Directive does not apply to some Raymarine products, we support its policy and ask you to be aware of how to dispose of this product.

The crossed out wheeled bin symbol, illustrated above, and found on our products signifies that this product should not be disposed of in general waste or landfill.

Please contact your local dealer, national distributor or Raymarine Technical Services for information on product disposal.

## Restriction of the use of certain Hazardous Substances



European models of this product use components that comply with the requirements of the Restriction of the use of certain Hazardous Substances (RoHS) Directive 2002/95/EC.

## Warranty

To register your Raymarine Satellite TV system ownership, please take a few minutes to fill out the warranty registration card found in the box, or visit [www.raymarine.com](http://www.raymarine.com) and register on-line.

It is important that you register your product to receive full warranty benefits. Your system package includes a barcode label indicating the serial number of the unit. You should stick this label to the warranty registration card.

## Handbook information

To the best of our knowledge, the information in this handbook was correct as it went to press. However, Raymarine cannot accept liability for any inaccuracies or omissions it may contain. In addition, our policy of continuous product improvement may change specifications without notice. As a result Raymarine cannot accept liability for any differences between the product and the handbook.



## What does a typical system look like?

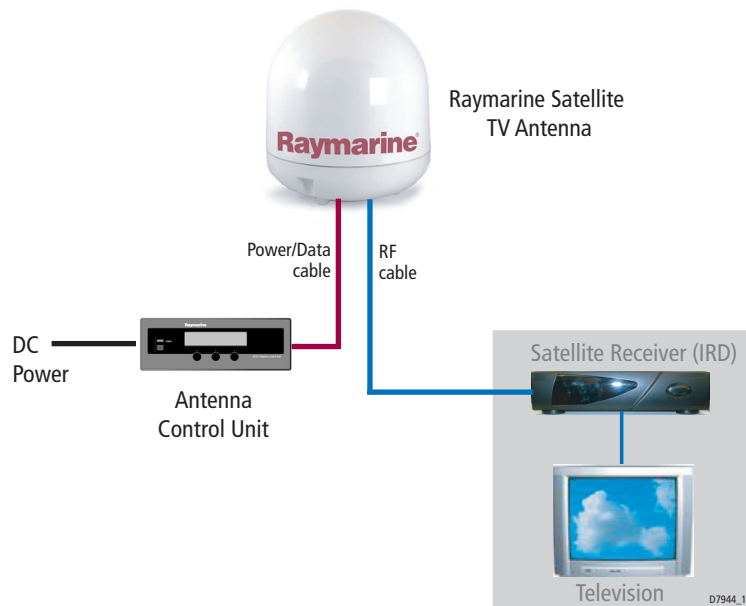

**Note:** *Satellite receivers, televisions and subscription services must be purchased separately.*



# Installation

## EMC installation guidelines

All Raymarine equipment and accessories are designed to the best industry standards for use in the recreational marine environment.

Their design and manufacture conforms to the appropriate Electromagnetic Compatibility (EMC) standards, but correct installation is required to ensure that performance is not compromised. Although every effort has been taken to ensure that they will perform under all conditions, it is important to understand what factors could affect the operation of the product.

The guidelines given here describe the conditions for optimum EMC performance, but it is recognized that it may not be possible to meet all of these conditions in all situations. To ensure the best possible conditions for EMC performance within the constraints imposed by any location, always ensure the maximum separation possible between different items of electrical equipment.

For optimum EMC performance, it is recommended that wherever possible:

- Raymarine equipment and cables connected to it are:
  - At least 3 ft. (1m) from any other equipment transmitting or carrying radio signals. In the case of Single Side Band (SSB) radio, the distance should be increased to 7 ft. (2m).
  - More than 7 ft. (2m) from the path of a radar beam. A radar beam can normally be assumed to spread 20 degrees above and below the radiating element.
- The equipment is supplied from a separate battery to that used for engine start. Voltage drops below 10 V, and starter motor transients, can cause the equipment to reset. This will not damage the equipment, but may cause the loss of some information and may change the operating mode.

- Raymarine specified cables are used. Cutting and rejoining these cables can compromise EMC performance and must be avoided unless doing so is detailed in the installation manual.

### Suppression Ferrite

If a suppression ferrite is attached to a cable, this ferrite should not be removed. If the ferrite needs to be removed during installation it must be reassembled in the same position. Always use the ferrites supplied by Raymarine.

### Connections to other equipment

If your Raymarine equipment is to be connected to other equipment using a cable not supplied by Raymarine, a suppression ferrite **MUST** always be attached to the cable near to the Raymarine unit.

## What's in the box?....

### Raymarine STV Antenna Unit

houses the antenna positioning mechanism, low noise block (LNB), power supply and control elements within a molded radome.

Connectors on the underside of the base plate join the power, signal and control cabling from the below decks units.



### Antenna Control Unit (ACU)

controls power to the antenna unit via the On/Off switch. The three soft keys enable satellite programming and antenna diagnostics to be carried out.

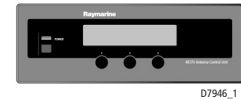

### Installation kit

contains the items required for securing the antenna unit and ACU to your boat.

- 4 x Hexagonal bolts.
- 4 x Flat washers.
- 4 x Spring washers.
- 4 x Self tapping screws.

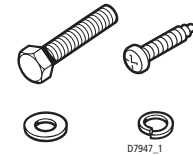

### System cables

Your Raymarine STV package also includes the following cables:

- RO8134 - 15 m Power and Data cable - used for connecting the antenna and ACU.
- RO8133 - 10 m Power cable - used for connecting the ACU to the DC power supply. (45STV models only).
- RO8280 - 10 m Power cable - used for connecting the ACU to the DC power supply. (60 STV models only).
- RO8135 - 15 m RF cable - used for connecting the Antenna and Integrated Receiver Decoder (IRD).
- RO8138 - 1.8 m PC cable - used for connecting the ACU to a personal computer for system set up and diagnostics.

### CD-ROM

Contains the software for programming your system and carrying out system diagnostics using a personal computer.

## What tools do I need to install my TV system?....

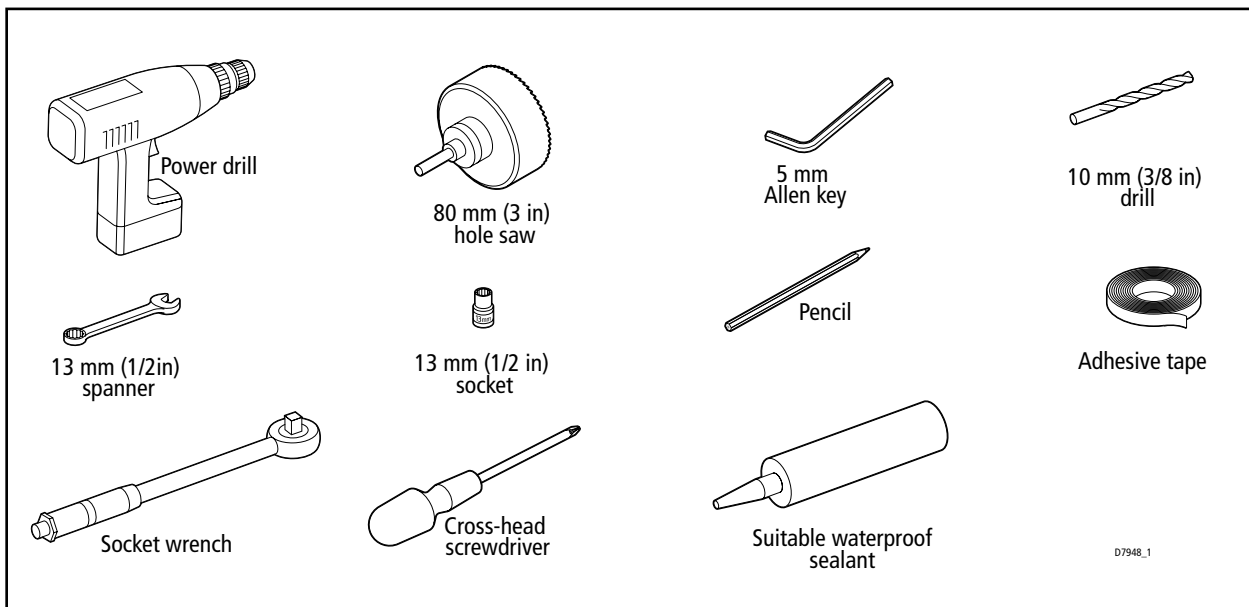

## How do I plan the installation?...

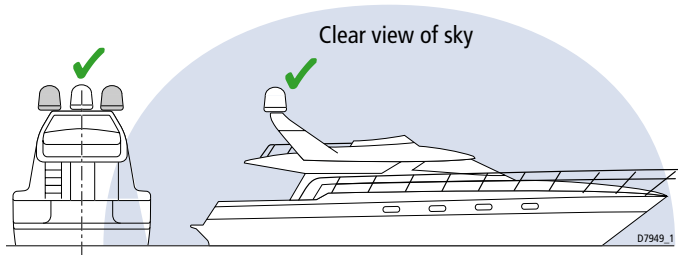

When choosing a location for the antenna, consider the following points:

- Make sure you place it where there is an all round clear view of the horizon.
- It should not be too high above the water - the maximum recommended height is one not exceeding half the length of your boat.
- It should be as near to the centerline of the boat as possible.
- The mounting platform should be rigid and not subject to excessive vibration.
- It should be away from the edge of the boat - this will avoid unnecessary motion which can affect reception.

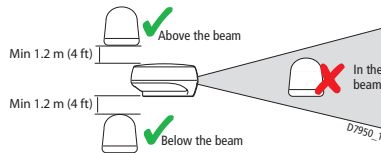

It should be clear of any radar as this may prevent the antenna working correctly.

Make sure nearby objects do not block the antenna. It requires a  $+15^{\circ}$  to  $+90^{\circ}$  look angle to receive satellite signals

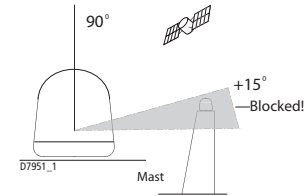

## Cables

You need to consider the following points before installing the system cables:

- All cables need to be adequately clamped and protected from physical damage and exposure to heat - avoid running cables through bilges, doorways, or close to moving objects.
- Acute bends must be avoided.
- Where a cable passes through an exposed bulkhead or deckhead, a watertight gland or swan neck tube should be used.

## Power requirements

You need to consider the following power requirements:

- Your Raymarine Satellite TV system has been designed to work on a boat's power supply rated at 12 V DC.
- If your boat's power supply is rated at 24 V DC you will need to install a suitable DC power inverter to reduce the supply voltage to 12 V DC.
- If your IRD(s) and television(s) require a 220/240 V AC power supply, you will need to install a suitable DC to AC converter to operate the units from your boat's DC power supply.

---

## Extending the cables

The cables that have been supplied with your Raymarine Satellite TV system should be of adequate length to complete the installation on most boats. However, should it be necessary to extend a cable the following points should be considered:

### Power and data cable

This cable is supplied at a length of 15 m.

If a longer length is required you should replace this cable with Raymarine Part No.E96007 - 30 m Power/Data cable.

### Power cable

This cable is supplied at a length of 10 m.

### RF cable

This cable is supplied at a length of 15 m.

If a longer length is required you should replace this cable with Part No. E96008 which will extend the available cable length to 30m. Additional length can be achieved by joining the supplied RF cable and the extension together to give a maximum available cable length of 45m.

**Note:** *The stated cable lengths should not be exceeded as this may result in reduced performance of your system.*

## How do I install the ACU?....

### ACU dimensions

The dimensions of the ACU are shown below:

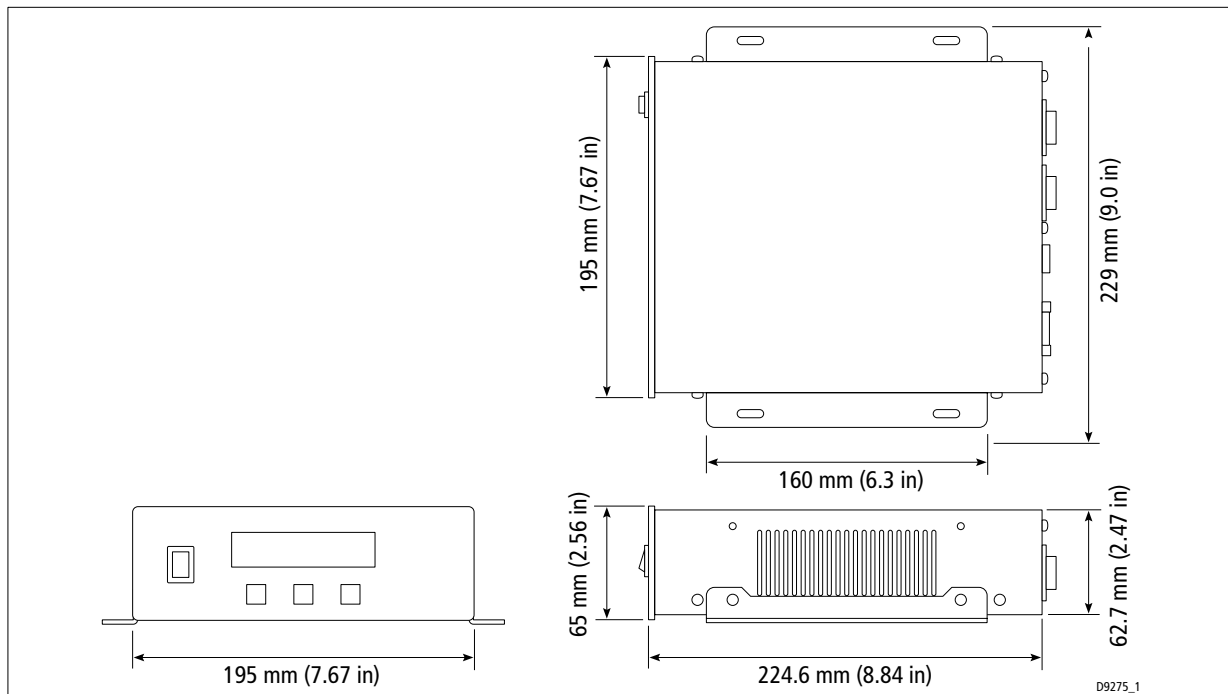



## Installing the ACU

The ACU should be installed below decks, in a position that is:

- dry.
- well ventilated.
- easily accessible.
- near your main TV viewing area.

The ACU should be installed using the two fixing brackets supplied. These brackets can be placed on the sides of the unit to provide a top or bottom fix.

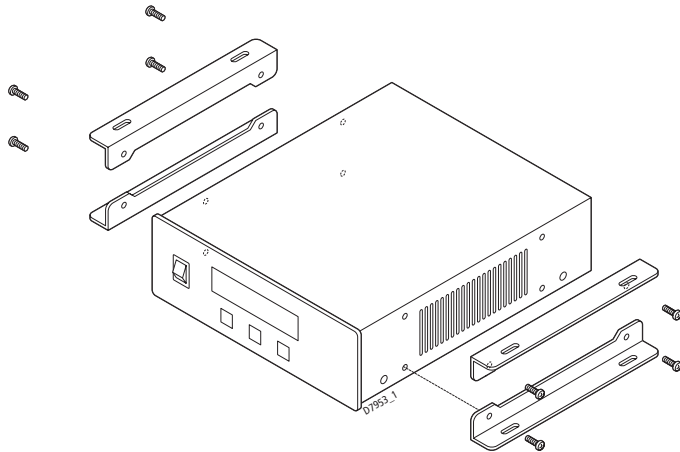

## To install the ACU:

1. Select the installation site, ensuring that the proposed site meets the criteria described above.
2. Using the screws supplied fix the mounting brackets to the sides of the ACU.
3. Place the ACU in the position where it is going to be installed.
4. Connect the cables to the rear of the ACU.
5. Using a pencil, mark the 4 hole positions (2 each side) for securing the mounting brackets.
6. Using a suitable drill bit, drill the 4 holes in the required position.
7. It is good practice to countersink the mounting holes to avoid damage to the mounting surface.
8. Using suitable screws, secure the ACU into position.

## How do I install the antenna?....

### Preparing the antenna

1. Using a 5 mm allen key, remove the antenna dome retaining bolts and dome.
2. Remove the foam transit restraints from the antenna base.
3. Replace and secure the antenna dome.

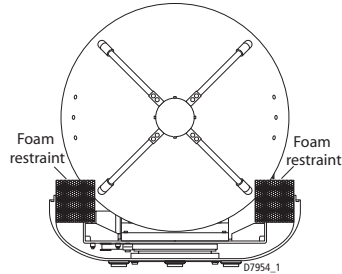

### Securing the antenna

Secure the antenna to the base using bolts, spring washers and flat washers.

The bolts should be tightened to a torque of 30 Nm (22.1 ft.lb.) to ensure that the foam sealing ring is compressed to prevent water ingress.

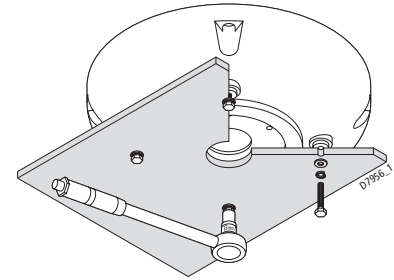

### Preparing the mount

1. Using adhesive tape, attach the template to the mounting surface, ensuring that it is parallel to your boat's centerline as marked on the template.
2. Using a suitable hole saw, remove the shaded center portion
3. Drill four 10 mm holes in the positions indicated.
4. It is good practice to countersink the mounting holes, and smooth the edges of the center hole with a suitable file to avoid damage to the mounting surface.

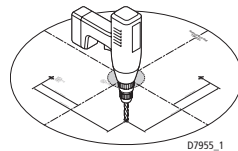
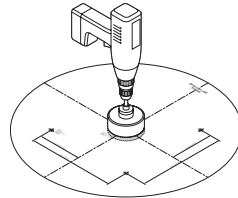

## How do I connect the system cables?....

### Connecting the antenna

#### Antenna baseplate

There are two types of antenna baseplate that can be fitted to your Raymarine TV System. the types are:

- 2 RF port connectors.
- 4 RF port connectors.

Which type is fitted depends on your area of operation and the antenna model. The models are:

#### Raymarine 45STV system

All antennas are fitted with a 2 RF port connector baseplate.

#### Raymarine 60STV system

##### Regions with circular polarization

North America, South America (DirecTV) - 2 RF port connectors.

##### Regions with linear polarization

Europe and Middle East - 4 RF port connectors.

Australia, China, and New Zealand - 2 RF port connectors.

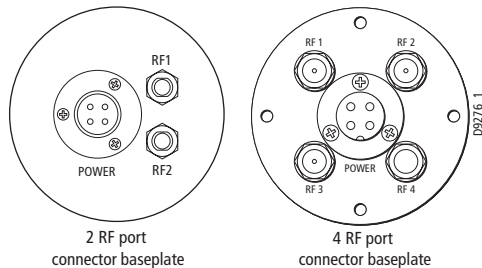

#### To connect the antenna

1. Pass the power/data cable through the access hole of the mounting plate and connect it to the power/data connector on the antenna base plate.

**Note:** *It is good practice to coat the threads of all connector s with a small amount of a suitable waterproof marine sealant prior to securing them.*

2. Hand tighten the power/data cable connector. Take care not to over-tighten the nut, as this will damage the connector.
3. Remove the protective cap from the RF 1 connector.
4. Connect the RF cable to the RF 1 connector and secure using a 13 mm spanner. Take care not to over-tighten the nut, as this will damage the connector.

**Note:** *The base plate connectors must be suitably protected from water ingress when the antenna unit is installed on an open structure, e.g. a tuna tower.*

## Connecting the ACU

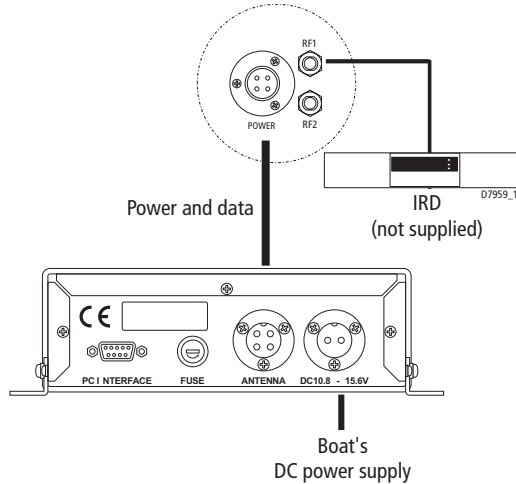

### CAUTION

#### In-line fuse

If you do not have a breaker in the power circuit, an in-line 5 A quick blow fuse should be fitted to the positive (white) lead of the power cable.

#### To connect the antenna control unit:

1. Connect the power and data cable to the connector on the rear panel of the ACU.
2. Connect the RF cable to the connector on the rear panel of the IRD.
3. Connect the DC power supply to the connector on the rear of the ACU.

## How do I configure the system?...

Your Raymarine Satellite TV system can be connected with multiple IRDs at the same time to receive pictures in different cabins offering the maximum choice of channels. The following section shows the different combinations available and their connections. In all cases the ACU must be connected to the power/data connector of the antenna base plate.

### Systems with 2RF connector baseplate

#### Single IRD

This is the basic method for connecting your Raymarine Satellite TV system

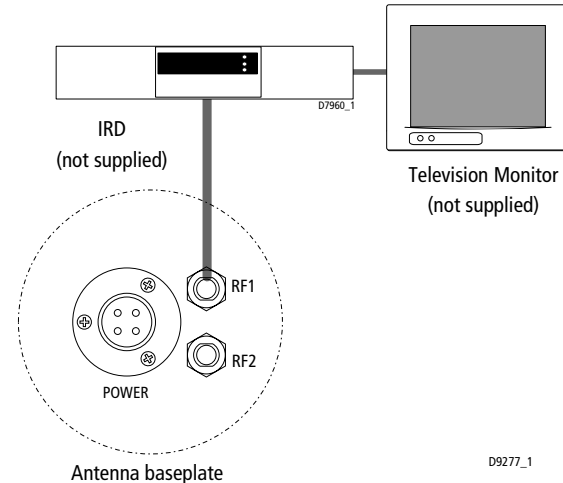

The RF cable from the antenna base plate should be connected to 'LNB', 'ANT' or 'Satellite In' on the rear panel of the IRD.

## Twin IRDs

You can connect two IRDs to your antenna as shown in the following diagram. However, only one of the IRDs can be configured as a two satellite receiver. The other IRD needs to be configured as a one satellite receiver.

The two satellite receiver determines which satellite is tracked, while the other receiver can watch any channel which is available from the tracked satellite.

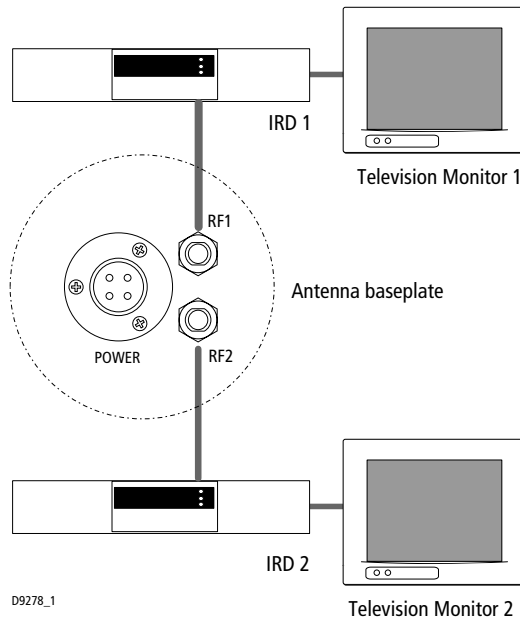

D9278\_1

As in the single IRD option the RF cables from the antenna base plate should be connected to 'LNB', 'ANT', or 'Satellite In' on the rear panel of the IRD.

Full details on configuring your system IRDs will be found in the relevant Manufacturer's handbook.

## Multiple IRDs

**IMPORTANT:** Due to satellite polarization, incorrect connection in systems using multiple IRDs will result in signal degradation. Make sure you select the correct method of connection for your area of operation.

### North American systems and South America (DirecTV)

In order to connect three or four IRDs to the antenna, you will need to purchase an active multi-switch with 2 satellite 'in' ports (Raymarine recommends the Channel Master 6314 IFD), and the necessary additional RF cables.

The multi-switch has to be installed between the antenna unit and the IRDs as shown in the following diagram.

When you use a multiswitch, the signal from the satellite receiver can no longer tell the antenna when to automatically change satellites. In order to change the satellite being tracked, you must use the ACU. For example, in some areas DirecTV programming is found on DTV101 and DTV119 (local channels) When tracking DTV101, all of the receivers can receive programmes from that satellite. If you want to see programmes on DTV119, you need to manually change the satellite being tracked by pressing Satellite B on the ACU. This means that all receivers can then watch the programmes available on DTV119.

#### To connect three or four IRDs:

1. Connect an RF cable to RF1 and another to RF2 on the antenna base plate.
2. Connect the RF1 cable to LNB LHCP/+18 V on the multi-switch.
3. Connect the RF2 cable to LNB RHCP/+13 V on the multi-switch.
4. For each output required, connect an RF cable from an OUT connector of the multi-switch to the LNB or ANT connector of the individual IRD units.
5. Terminate any unused connections with a suitable 75 Ohm DC terminator block.

6. Connect the multi-switch to the appropriate DC power supply.

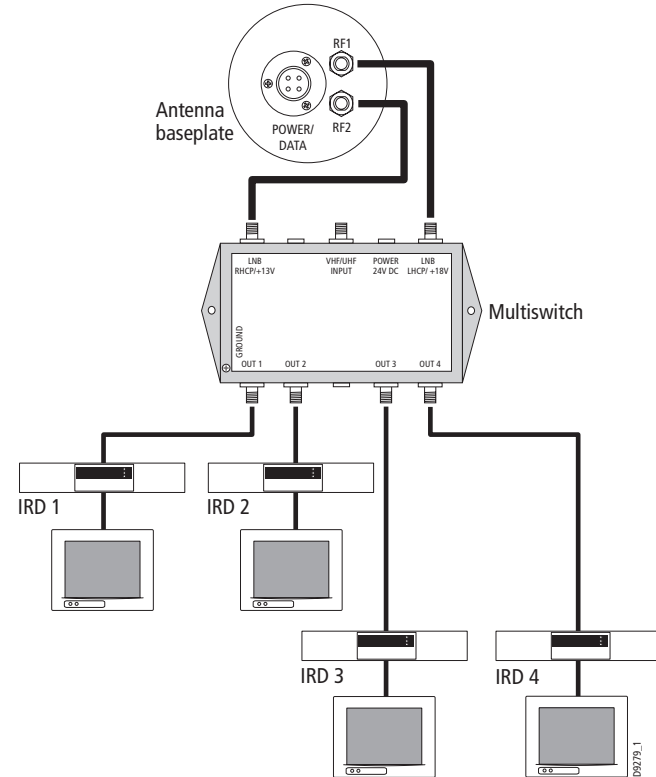

## North American systems - DirecTV

This version of a multi-switch installation uses a DiSEqC supplier - Raymarine Part No. A96014 - and enables you to change the satellite being tracked as you change channels using the IRD master instead of the ACU.

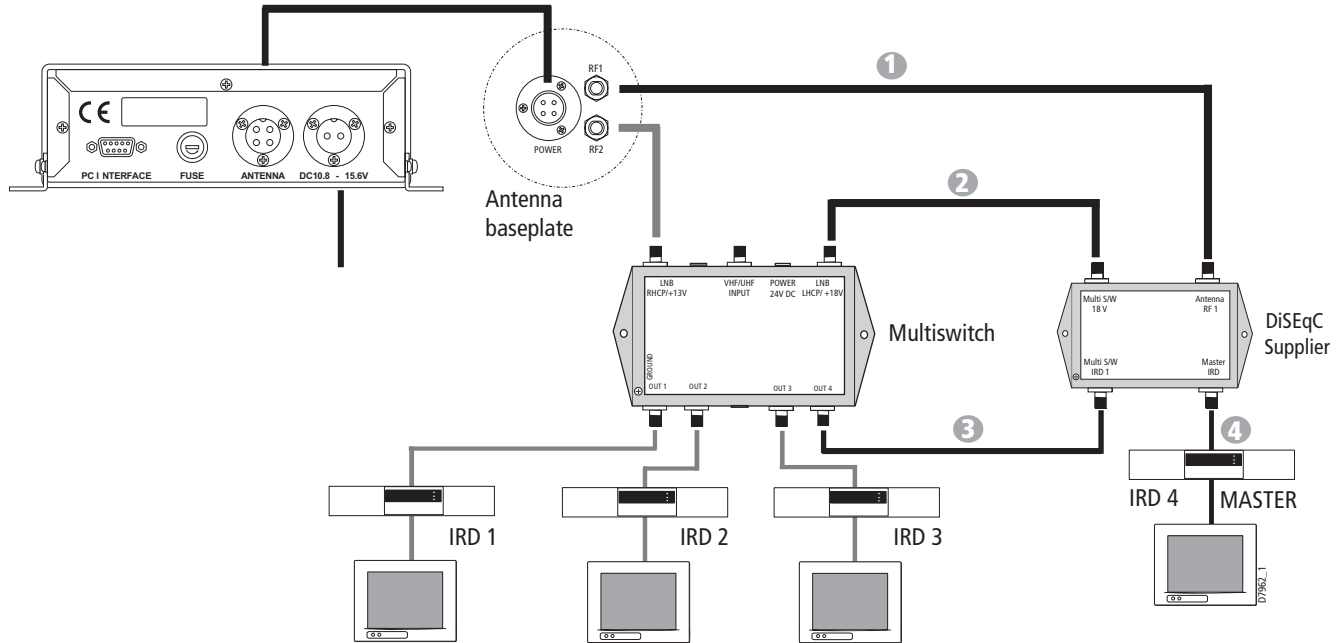

### To connect a multi-switch and DiSEqC Supplier:

1. Connect a 15 m RF cable between *Antenna RF1* of the DiSEqC Supplier and *RF1* on the antenna baseplate.
2. Connect a 30 cm RF cable between *Multi SW 18V* of the DiSEqC supplier and *LHCPI (+18V)* of the multi-switch.
3. Connect a 30 cm RF cable between *Multi SW IRD1* of the DiSEqC supplier and any *OUT* of the multi-switch.
4. Connect a 3 m RF cable between *Master IRD* of DiSEqC supplier and *Satellite* of the Master IRD.
5. With the system powered:

- Set the ACU to ON.
  - The IRDs to OFF.
  - The television receivers to OFF.
6. Confirm that the antenna detects and tracks the DirecTV101 satellite.
  7. Set the Master IRD to ON.
  8. Set the Master IRD television receiver to ON.
  9. Set the remaining IRDs to ON.
  10. Set the remaining television receivers to ON.
- The system can now be controlled using the Master IRD.

### Europe, Australia, New Zealand, China, Middle East, South America (Sky)

In order to connect multiple IRDs to the antenna, you will need to purchase a suitable universal LNB multiswitch. The multiswitch has to be installed between the antenna unit and the IRDs as shown in the following diagram.

You should connect to either the vertical or horizontal high and low pairs depending whether you want to watch channels in the high or low bands. Only those channels in the selected band will be available for viewing.

#### To connect three or four IRDs:

1. Connect an RF cable to RF1 and another to RF2 on the antenna base plate.
2. Connect the RF1 cable to either Lo/Ver or Hi/Ver. This will depend on whether the desired programming is in the vertical or horizontal low band.
3. Connect the RF2 cable to:
  - Lo/Hor if RF1 was connected to Lo/Ver.
  - Hi/Hor if RF1 was connected to Hi/Ver.
4. For each output required, connect an RF cable from an OUT connector of the signal splitter to the LNB or ANT connector of the individual IRD units.

5. Terminate any unused connections with a suitable 75 Ohm DC terminator block.

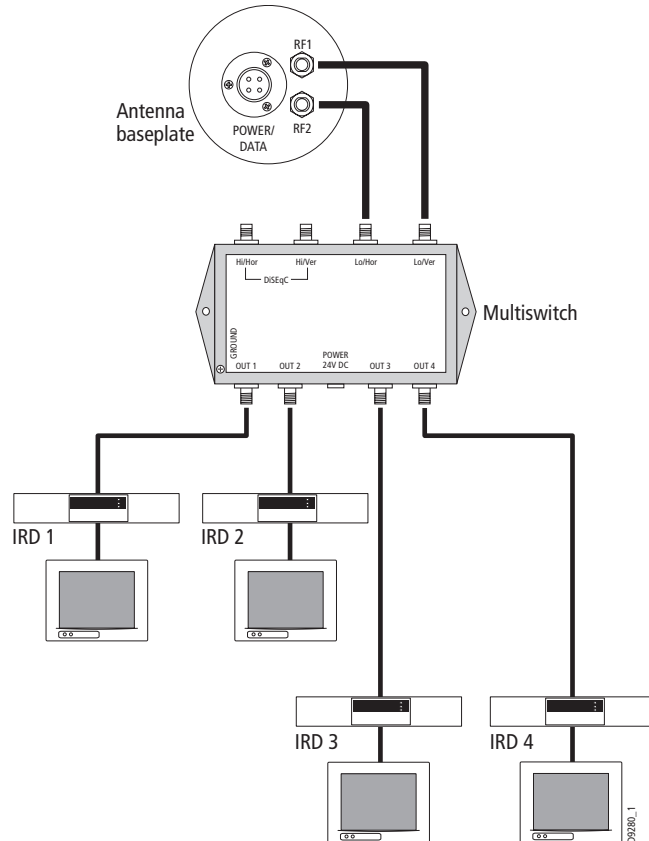



## System with 4 RF connector baseplate

### Single IRD

This is the basic method for connecting your Raymarine Satellite TV System.

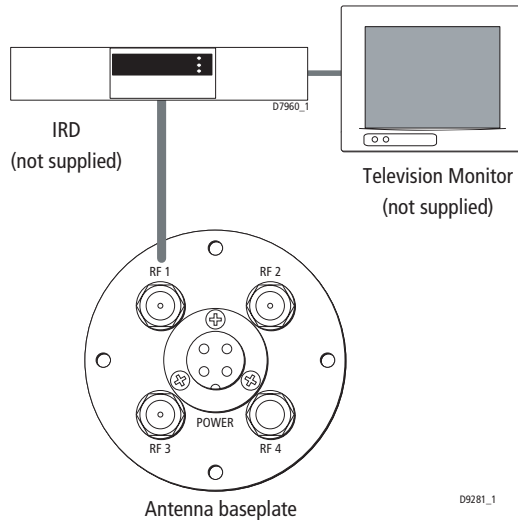

The RF cable should be connected from RF1 to 'LNB', 'ANT' or 'Satellite In' on the rear panel of the IRD.

### Twin IRDs

You can connect two IRDs to your antenna as shown in the following diagram. However, only one of the IRDs can be configured as a two satellite receiver. The other IRD needs to be configured as a one satellite receiver.

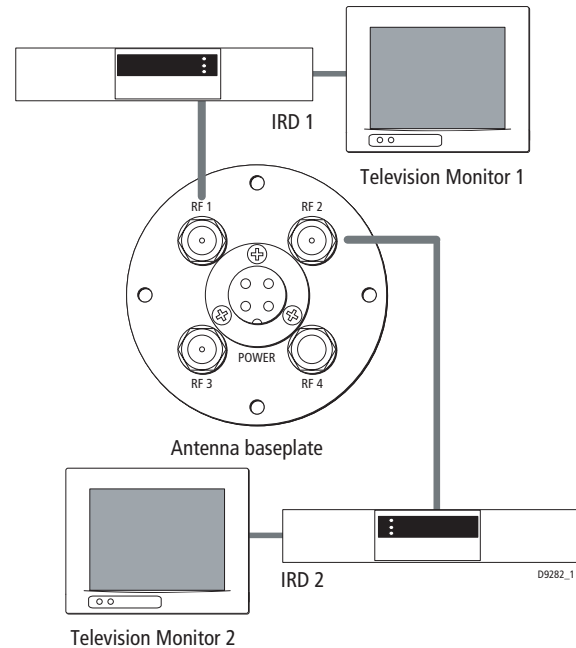

The two satellite receiver determines which satellite is tracked, while the other receiver can watch any channel which is available from the tracked satellite.

As in the single IRD option the RF cables from the antenna base plate should be connected to 'LNB', 'ANT', or 'Satellite In' on the rear panel of the IRD.

Full details on configuring your system IRDs will be found in the relevant Manufacturer's handbook.

## Multiple IRDs

In European systems fitted with a 4 RF connector baseplate there are two options for connecting multiple IRDs.

### Systems using up to 4 IRDs

In European systems all four RF outputs from the antenna can be connected to individual IRDs.

As in the single IRD option the RF cables from the antenna base plate should be connected to 'LNB', 'ANT', or 'Satellite In' on the rear panel of the IRD.

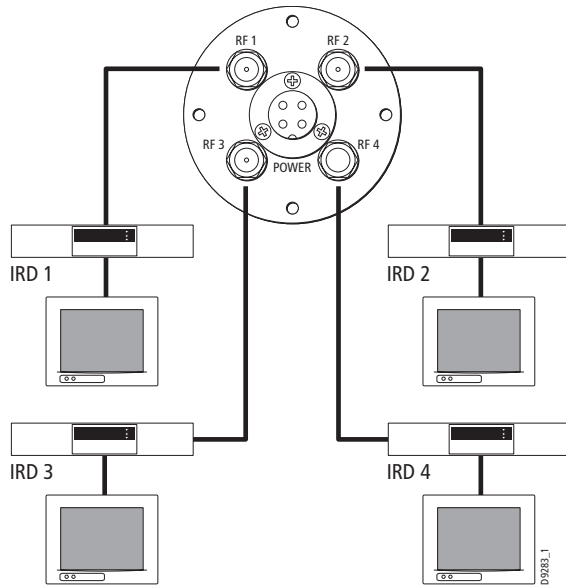

### Systems using more than 4 IRDs

To connect more than 4 IRDs you will need to install a suitable active multi-switch between the antenna and the IRDs.

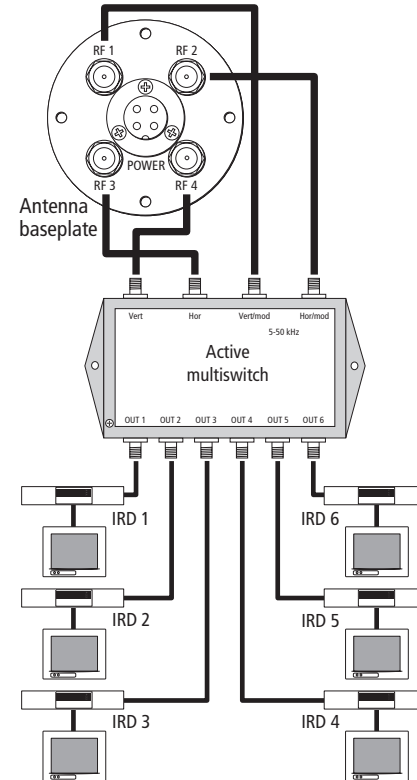

Connect the multiswitch in accordance with the manufacturer's instructions.

## Connecting your satellite TV system to an NMEA0183 GPS

**Note:** *This applies to Raymarine 60 STV systems only.*

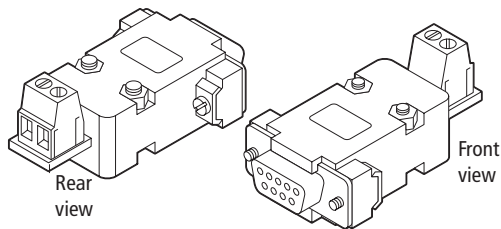

Using the 9 pin connector supplied, you can connect your satellite TV system directly to your boat's NMEA 0183 GPS system for improved tracking accuracy. You will also need:

- a length of cable suitable for connecting to your GPS antenna.
- a suitable connector block.

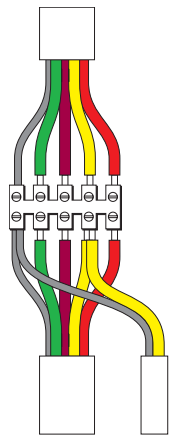

Red (12 - 32 V /+)  
 Yellow (NMEA out /+)  
 Brown (RTCM in /+)  
 Green (NMEA in /+)  
 Shield (0V/ ground / -)

### To connect your satellite TV system to an NMEA0183 GPS:

With the system powered OFF:

1. At a suitable point, cut your GPS antenna cable.
2. Strip back one set of wires and connect to a suitable connector block.
3. Strip back the other set of wires and place them in the connector block.

4. Strip back the wires from one end of the additional piece of cable and place the yellow (NMEA OUT) and ground wires into the connector block.
5. Tighten the connector block screws.
6. Strip back the wires on the free end of the additional piece of cable and place them in the connector block of the 9 pin connector.

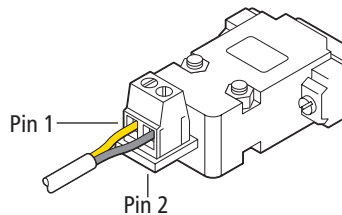

The YELLOW - NMEA OUT wire should be connected to PIN 1. The ground wire should be connected to PIN 2.

7. Connect the 9 pin connector to the PC connector on the rear of the ACU.

8. Power the system ON.

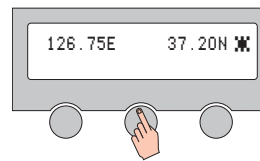

9. Press center softkey x 2. The NMEA GPS page appears.

A flashing icon right of the position indicates GPS is running and has a fix. A flashing underscore to the right of the position indicates GPS is running but does not have a fix.

No icon or underscore indicates GPS is not connected.



# System set up

## Introduction

This section of the handbook describes how to set up your Raymarine Satellite TV system after installation using the ACU or the Graphical User Interface (GUI) and includes the following functions:

- System start up.
- Change the default satellite.
- Monitor the antenna status.
- Enter set up mode.
- Setting the satellite pair.
- Setting the GPS.
- Setting the local frequency.
- Setting the DiSEqC method.
- Display versions.
- Setting antenna go position.
- Setting antenna move step.
- Setting the default satellites.

Many of the above functions will only be required at initial installation of your system.

**Note:** *The satellite names shown on the ACU screen in the following illustrations may differ from those on your ACU depending on your geographic location.*

## Set up using the ACU

### Start up

With the system installed and power applied, the ACU screen will show the following sequence:

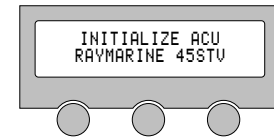

1. Communication is being established between the antenna and the ACU

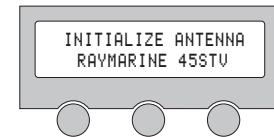

2. The antenna is initialized.

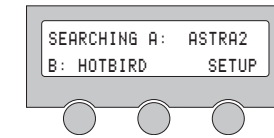

3. The antenna is searching for Satellite A.



4. The antenna has located the satellite and is now tracking

## Changing the default satellite

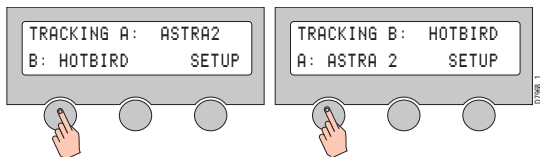

Your ACU is programmed with two default satellites. To change the default satellite, press the left hand soft key. The default satellite changes and is automatically tracked by the antenna.

## Monitoring the current status of the antenna



1. Antenna is searching for satellite A.



2. Antenna is tracking satellite A.

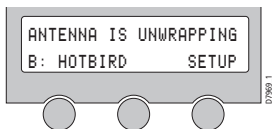

3. Antenna is unwrapping the cable.

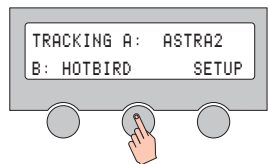

4. Antenna is again tracking satellite A. Press to display position detail.

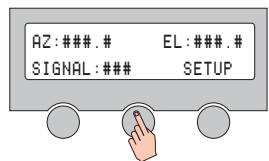

5. Antenna position detail and signal strength is displayed. Press center soft key to display NMEA GPS page.

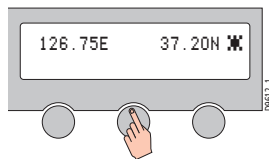

6. The NMEA GPS information is displayed. Press center soft key to return to antenna status display.(Standard models) Press center soft key to display skew angle page.(Premium models only).

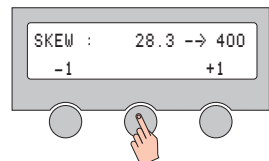

7. The skew angle is displayed. Press center soft key to return to antenna status display ( Premium models only).

## Set up mode

To enter set up mode:

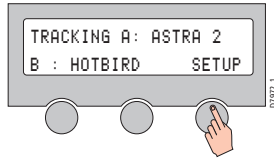

1. With the antenna tracking press **SETUP**.

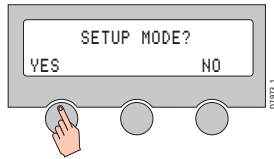

2. Press **YES** to enter setup mode.

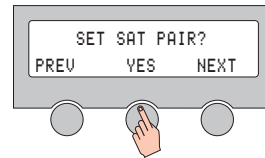

3. Press **YES** to set the satellite pair.

## Setting the satellite pair

This sequence applies to all satellite pairs except DirecTV:

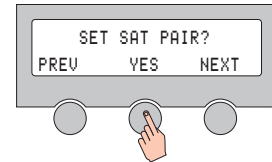

1. Follow steps 1 thru 3 for entering set up mode. Press **YES** to set satellite pair.

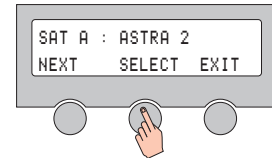

2. Set satellite A.  
Press **NEXT** to show alternative satellite name.  
Press **SELECT** to set chosen satellite to SAT A.  
Press **EXIT** to return to main set up menu.

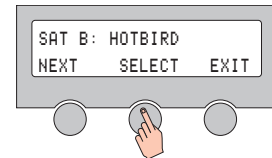

3. Set satellite B.  
Press **NEXT** to show alternative satellite name.  
Press **SELECT** to set chosen satellite to SAT B.  
Press **EXIT** to return to main set up menu.

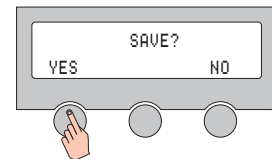

4. Press **YES** to save selections.  
Press **NO** to cancel and return to main setup menu.

## Setting the satellite pair - DirecTV

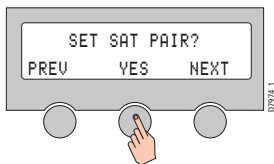

1. Follow steps 1 thru 3 for entering set up mode- see "Set up mode" on page 27. Press YES to set satellite pair.

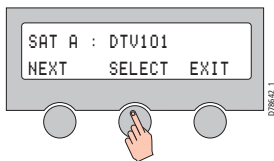

2. Set satellite A.  
Press NEXT to show alternative satellite name.  
Press SELECT to set chosen satellite to SAT A.  
Press EXIT to return to main set up menu.

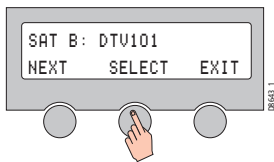

3. Set satellite B.  
Press NEXT to show alternative satellite name.  
Press SELECT to set chosen satellite to SAT A.  
Press EXIT to return to main set up menu.

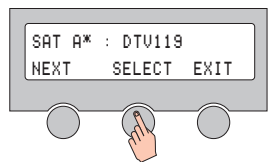

4. Set satellite A when DiSEqC is active from IRD.  
Press NEXT to show alternative satellite name.  
Press SELECT to set chosen satellite to SAT A.  
Press EXIT to return to main set up menu.

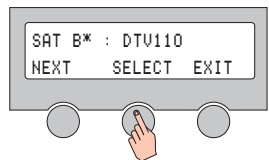

5. Set satellite B when DiSEqC is active from IRD.  
Press NEXT to show alternative satellite name.  
Press SELECT to set chosen satellite to SAT A.  
Press EXIT to return to main set up menu.

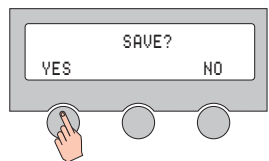

6. Press YES to save selections.  
Press NO to cancel and return to main setup menu.

**Note:** *DiSEqC is not used with Dish Network or ExpressVu satellites. This menu is displayed when the DiSEqC method - see page 34 is set to "Use to change sat".*



## Setting the GPS using the ACU

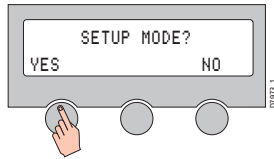

1. Press YES to enter set up mode.

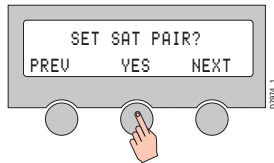

2. Press NEXT to enter GPS set up mode.

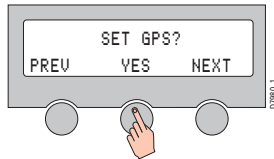

3. Press YES to set GPS.

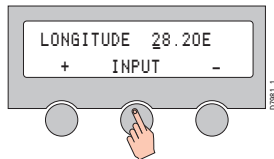

4. Input the longitude data.  
+ increases a value. - decreases a value.  
Change the underscored digit using the +/- buttons.  
Press INPUT to accept a value.

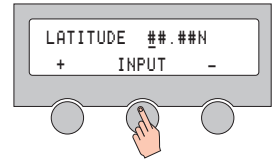

5. Input the latitude data.  
+ increases a value. - decreases a value.  
Change the underscored digit using the +/- buttons.  
Press INPUT to accept a value

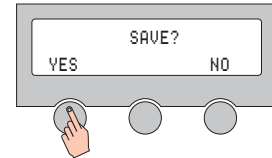

6. Press YES to accept the data.  
Press NO to cancel and return to main set up menu.

**Note:** *If your system is connected to a GPS antenna, the position will be updated in real time.*

## Edit satellite information

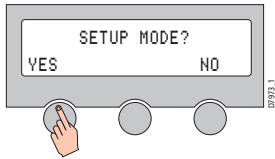

1. Press YES to enter set up mode.

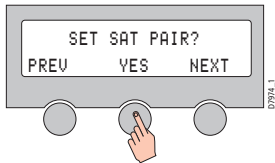

2. Press NEXT twice to enter Edit Sat Info menu.

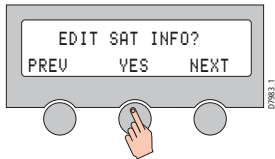

3. Press YES to enter edit menu.

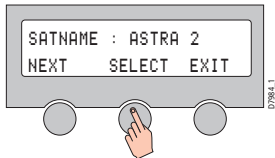

4. Set the satellite name.  
NEXT - shows next satellite name.  
SELECT - sets the displayed satellite for editing.  
EXIT - returns to the main set up menu.

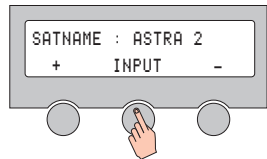

5. Input satellite name.  
+ increases a value. - decreases a value.  
Change the underscored digit using the +/- buttons.  
Press INPUT to accept a value

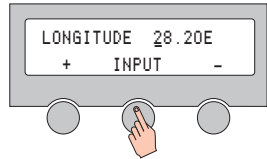

6. Input satellite position

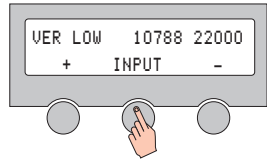

7. Input the tracking frequency (MHz) and symbol rate (kHz) for Vertical Low Band.

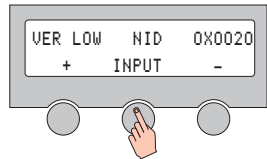

8. Input the Network ID (NID) for Vertical Low Band.

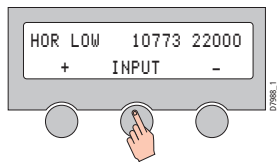

9. Input the tracking frequency (MHz) and symbol rate (kHz) for Horizontal Low Band.

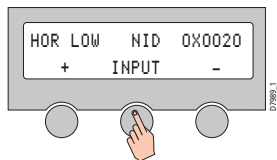

10. Input the NID for Horizontal Low Band.

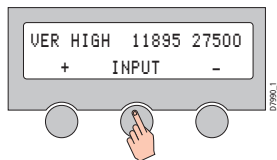

11. Input the tracking frequency (MHz) and symbol rate (kHz) for Vertical High Band.

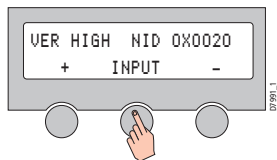

12. Input the NID for Vertical High Band.

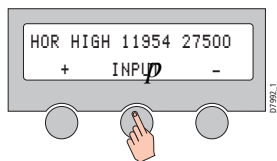

13. Input the tracking frequency (MHz) and symbol rate (kHz) for Horizontal High Band.

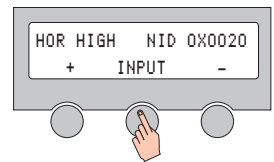

14. Input the NID for Horizontal High Band.

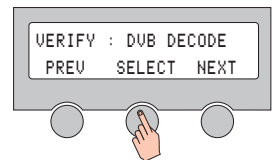

15. Select the verification method \* of tracking satellite.  
PREV - shows previous method.  
SELECT - set the displayed method.  
NEXT - shows next method.

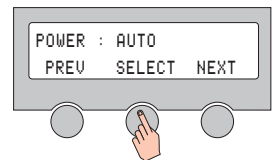

16. Select the power supplying method \*\* to the LNB. AUTO is recommended.  
PREV - shows previous method.  
SELECT - set the displayed method.  
NEXT - shows next method.

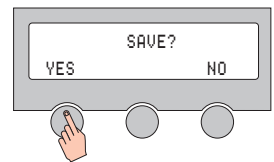

17. Press YES to accept the data.  
Press NO to cancel and return to main set up mode.

## \* Verification methods

SIGNAL - use only signal level for tracking.  
 DVB LOCK - use only DVB lock signal for tracking.  
 DVB DECODE - verify satellite using DVB decoding method for tracking.  
 DSS LOCK - use only DSS lock signal for tracking.

## \*\* Power supplying methods

AUTO - change voltage to LNB by IRD voltage.  
 ONLY 13 V - always supply 13 V to LNB.  
 ONLY 18 V - always supply 18 V to LNB.

**Note: (1)** *Raymarine does not recommend changing the satellite information unless advised to do so by the satellite provider.*

**(2)** *Vertical and horizontal polarization applies to regions with linear polarization only.*

## Setting the local frequency

### LNB systems in regions with circular polarization

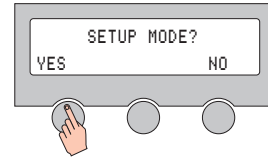

1. Press YES to enter set up mode.

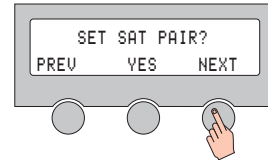

2. Press NEXT 3 times to enter the Local frequency menu.

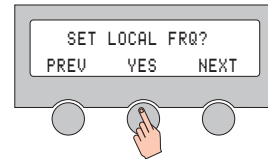

3. Press YES to set local frequency.

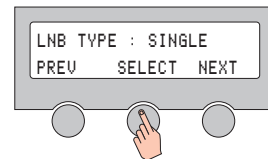

4. Select SINGLE LNB type.  
 PREV - shows previous LNB type.  
 SELECT - sets the displayed LNB type.  
 NEXT - shows the next LNB type.

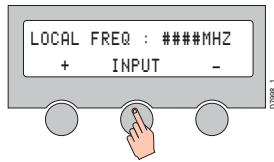

5. Input local frequency for the LNB.  
+ increases a value. - decreases a value.  
Change the underscored digit using the +/- buttons.  
Press INPUT to accept a value

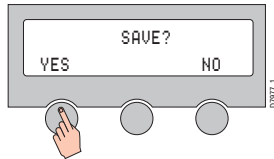

6. Press YES to accept the data.  
Press NO to cancel and return to main set up menu.

**Note:** Raymarine does not recommend changing the LNB type unless instructed to do so.

## LNB systems in regions with linear polarization

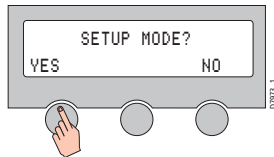

1. Press YES to enter set up mode.

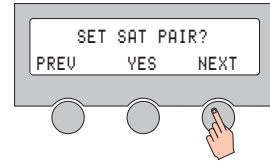

2. Press NEXT 3 times to enter Local frequency menu.

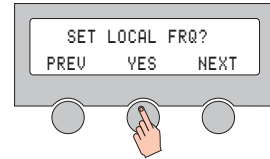

3. Press YES to set local frequency.

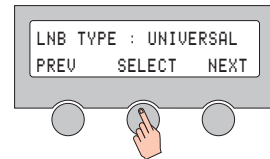

4. Select UNIVERSAL LNB type.  
PREV - shows previous LNB type.  
SELECT - sets the displayed LNB type.  
NEXT - shows the next LNB type.

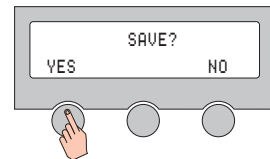

5. Press YES to accept the data.  
Press NO to cancel and return to main set up menu.

**Note:** Raymarine does not recommend changing the LNB type unless instructed to do so.

## Setting the DiSEqC method

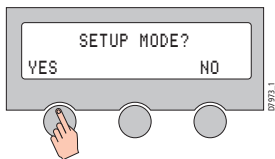

1. Press YES to enter set up mode.

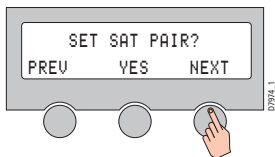

2. Press NEXT 4 times to go to the Use DiSEqC menu.

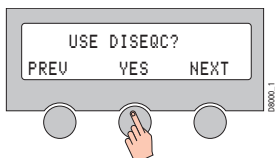

3. Press YES to enter the DiSEqC menu.

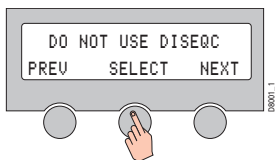

4. Select the DiSEqC method\*  
NEXT - shows next DiSEqC method.  
SELECT - sets the displayed method.  
EXIT - returns to main set up menu.

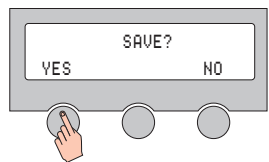

5. Press YES to accept the selection.  
Press NO to cancel and return to main set up menu.

### \* DiSEqC method

DO NOT USE DISEQC - DiSEqC is not used.

USE TO CHANGE BAND - DiSEqC is used to change high and low bands (Europe).

USE TO CHANGE SAT - DiSEqC is used to change satellite being tracked (US - DirecTV).

## Setting the LNB skew angle

**Note:** This menu is only applicable to Raymarine 60STV Premium models

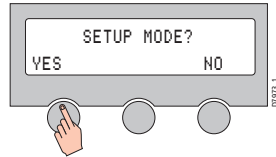

1. Press YES to enter set up mode.

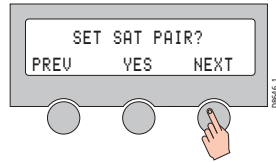

2. Press NEXT 5 times to enter the Local frequency menu.

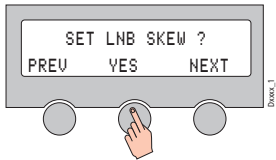

3. Press YES to view LNB skew.

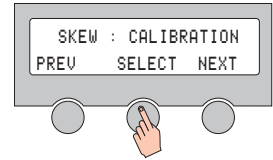

4. Select skew angle adjustment method\*.  
 PREV - view previous setting  
 NEXT - view next setting  
 SELECT - select the current setting

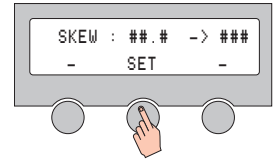

5. Press + to move LNB clockwise  
 Press - to move LNB counter clockwise  
 Press SET to accept new LNB skew position.

**Note:** \* *CALIBRATION* - uses the skew sensor motor to position the LNB.  
*MANUAL* - enables you to set the skew angle manually according to signal strength.

## Display version

This sequence enables you to see what version of antenna and ACU software versions are installed on your system.

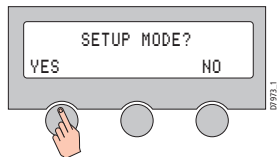

1. Press YES to enter set up mode.

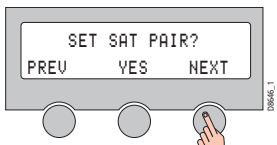

2. Press NEXT 5 times to go to View Version menu.

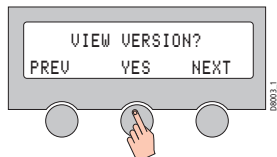

3. Press YES to view product name and software versions.

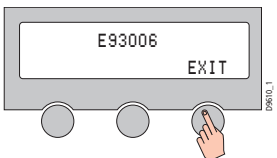

4. Product name is displayed. Press EXIT to return to main set up menu.

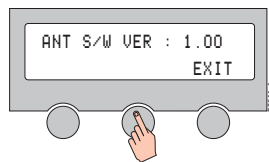

5. Antenna software version is displayed. Press EXIT to return to main set up menu.

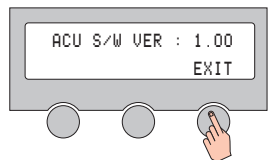

6. ACU software version is displayed. Press EXIT to return to main set up menu.

## Setting antenna go position

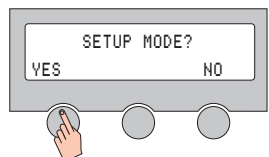

1. Press YES to enter set up mode.

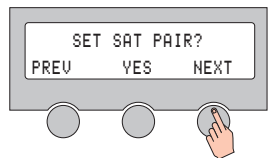

2. Press NEXT 6 times to enter Go Position menu.



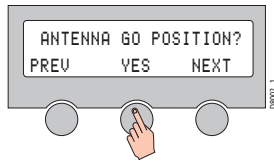

3. Press YES to enter Go position.

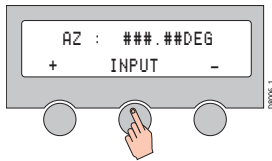

4. Input position value for azimuth (AZ) axis.  
+ increases a value. - decreases a value.  
Change the underscored digit using the +/- buttons.  
Press INPUT to accept a value.

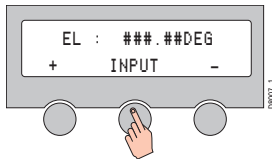

5. Input position value for elevation (EL) axis.  
+ increases a value. - decreases a value.  
Change the underscored digit using the +/- buttons.  
Press INPUT to accept a value.

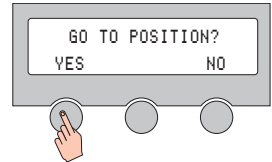

6. Press YES to send position command and display current position during motion.  
Press NO to return to antenna go position menu.

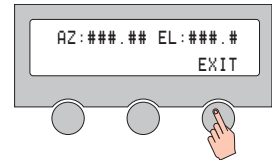

7. Press EXIT to return to main set up menu.

## Setting antenna move step

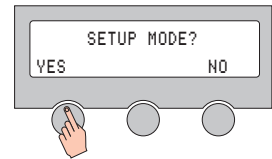

1. Press YES to enter set up mode.

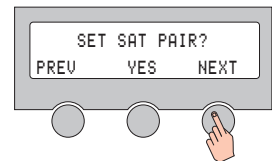

2. Press NEXT 7 times to go to the Ant move step menu.

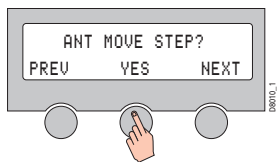

3. Press YES to enter the Ant move step menu.

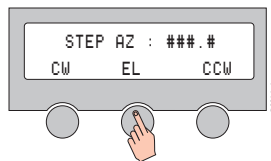

4. Move the antenna in the AZ axis.  
 CW - move clockwise.  
 EL - go to the elevation control screen.  
 CCW - move counter-clockwise.

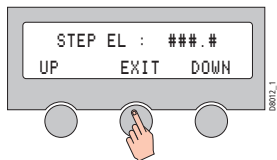

5. Move the antenna in the EL axis.  
 UP - move in up direction.  
 EXIT - go to Ant move step menu.  
 DOWN - move in down direction.

## Setting defaults

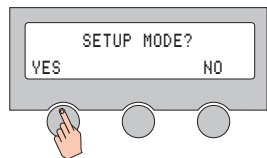

1. Press YES to enter set up mode.

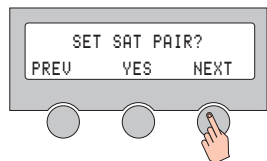

2. Press NEXT 9 times to go to Set default menu.

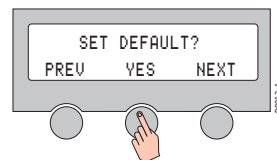

3. Press YES to set default parameters.

## Set up using the Graphical User Interface

You can also set up your Raymarine Satellite TV system using the Graphical User Interface (GUI) which can be found on the CD-ROM. The CD-ROM contains folders for the different areas of operation. Open the correct folder for your area of operation. The method of operation is the same for all versions of the GUI.

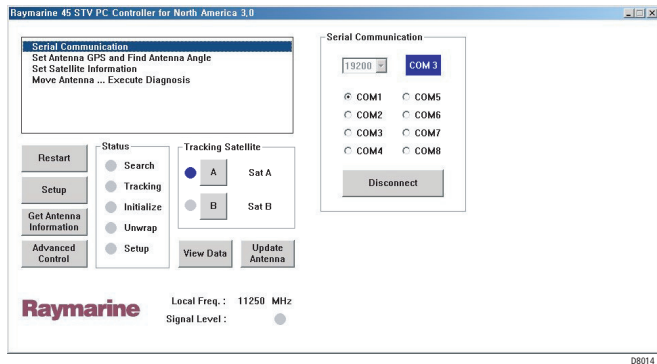

The GUI program enables you to set up the antenna through a PC to maximize system performance and diagnostics.

### To operate the GUI

1. Connect one end of the PC data cable to the PC INTERFACE connector on the rear of the ACU.
2. Connect the other end of the PC data cable to a serial port or serial to USB converter on your PC.
3. Place the CD-ROM supplied with your system into the CD-ROM drive of your computer.

4. Using Windows Explorer to access the contents of the CD-ROM, open the program 'Raymarine Satellite TV Controller.exe'. The GUI will be displayed on your PC screen.
5. Power up the antenna and ACU.
6. Press the center button of the ACU x 2, the PC/GPS page appears.
7. Press the button on the left to select *PC* setting.

### GUI main menu

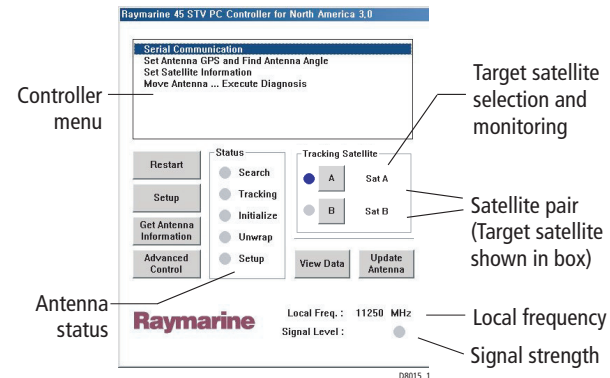

The GUI main menu allows you to select a function and to see the antenna status at a glance, and consists of the following areas:

### Controller menu

The controller menu enables you to select the task that you want to carry out. Place the cursor over the required task, which will be highlighted in blue, click, and the GUI will change to show the data boxes relevant to that task.

## Antenna status

The antenna status information shows monitoring and set up information for your antenna.

## Target satellite selection and monitoring

This section enables you to set up satellite tracking and monitoring.

## Satellite pair

This section shows satellites being tracked.

## Local frequency and signal strength

This section shows the local satellite frequency and signal strength.

## Serial port set up

Having connected the ACU to your PC, communication must be established between the two., this requires the communication speed and the serial port to be set up. You can then use the GUI to configure the antenna settings.

## To set up the serial port

1. Connect the ACU and PC as described in "To operate the GUI" on page 39.
2. From the menu options select 'Serial Communication. The serial communication screen is displayed.
3. Click on the drop down menu to select the baudrate setting. It should be 19200 bps.
4. Click the circle next to the serial port number that you want to use. The selected port is shown next to the baudrate setting.
5. Click the 'Connect/ Disconnect' button to establish communication. The button label changes as you click to show connection status.

Once communication between the ACU and antenna has been established you can configure the settings for your antenna.

## The GUI control soft keys

The following is an explanation of the operation of the different GUI soft keys:

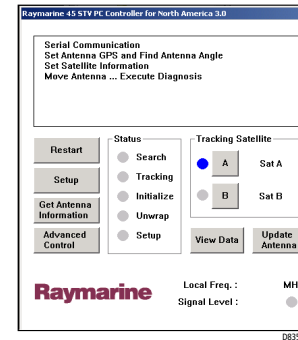
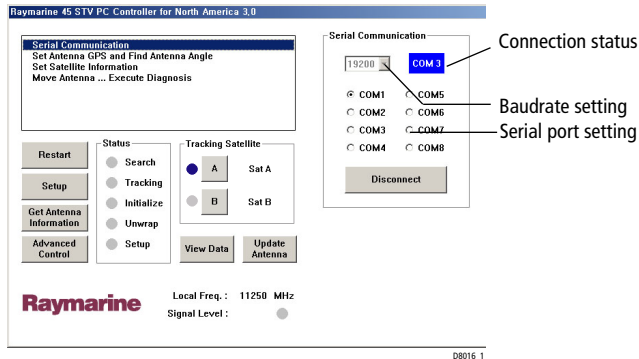

## Restart

Click this soft key to restart the antenna tracking the chosen satellite.

## Setup

Click this soft key to enter the GUI set up mode prior to making any changes.

## Get Antenna Information

Click this soft key to display the current system settings.

## Advanced Control

This is a password protected area for dealer use only.

## View Data

Click this soft key to load the factory default settings into the GUI program.

## Update Antenna

Click this soft key to send the factory default settings to the antenna. Remember that this will not restart the system.

## Setting the GPS

Your system antenna uses GPS information to enable it to track the satellite faster. The better the GPS information, the better the antenna performance.

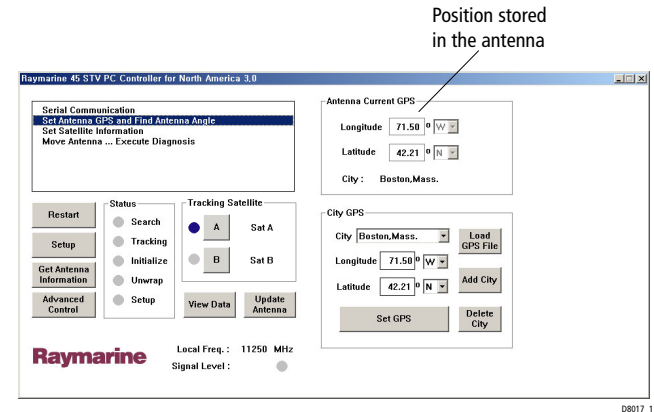

There are two ways in which GPS information can be edited:

### Method 1- Your actual position

By obtaining your exact position from your boat's GPS system, you can input this into the antenna memory.

1. Click 'Set Antenna GPS and Find Antenna Angle' in the menu options. The set GPS screen is displayed.
2. Click 'Setup'. The GUI will now enter set up mode.
3. Click on the Longitude box and enter your longitude in degrees and minutes format, e.g. 71.50°.

4. Click the drop-down arrow at the right of the longitude box and select W or E according to your longitude.
5. Click on the latitude box and enter your latitude in degrees and minutes format.
6. Click the drop-down arrow at the right of the latitude box and select N or S according to your latitude.
7. Click 'Set GPS' to save this information and set the GPS.
8. Click 'Restart'. The system leaves set up mode and the antenna will start tracking.

### Method 2 - Selecting the nearest city.

If you are unable to enter your exact position, you can enter the latitude and longitude for the nearest city.

1. Click 'Set Antenna GPS and Find Antenna Angle' in the menu options. The set GPS screen is displayed.
2. Click 'Setup'. The GUI will now enter set up mode.
3. Click on the arrow at the right of the 'City' box. A drop-down menu of city names according to your area of operation (US or Europe) appears.
4. Scroll down the list and select the city which is nearest to your current position. The latitude and longitude information for the selected city is displayed.
5. Click 'Set GPS' to save this information.
6. Click 'Restart'. The system leaves set up mode and the antenna will start tracking.

### Editing the satellite information

This section of the GUI enables you to edit satellite information

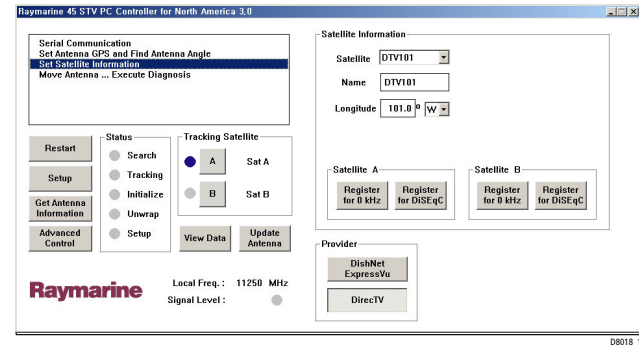

### To edit a satellite's information:

1. Click 'Set Satellite Information' in the menu options. The set satellite information screen is displayed.
2. Click 'Setup'. The GUI will now enter set up mode.
3. Click on the arrow at the right of the Satellite box. A drop-down menu of satellites appears.
4. Scroll down and select the satellite that you want to edit. The satellite name, its latitude and longitude and method of verification will be displayed.

You can now change and edit the data for the selected satellite using the following command buttons:

- Register for Satellite A - registers the selected satellite as Sat A of the satellite pair.
  - Register for Satellite B - registers the selected satellite as Sat B of the satellite pair.
5. Click 'Restart'. The system leaves set up mode and the antenna will start tracking.

## Setting antenna angle, move step and diagnosis.

You can move the antenna to a new target position or carry out diagnosis using the Move antenna - Execute diagnosis function of the GUI.

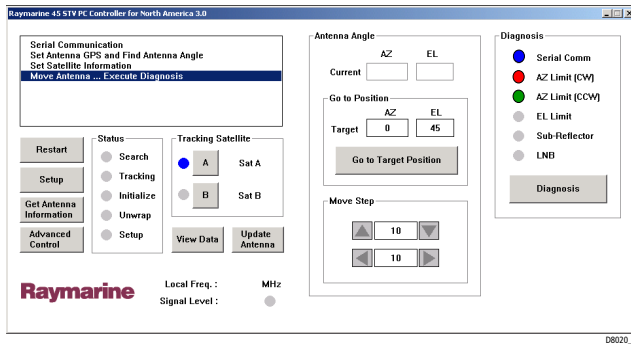

### Moving the antenna to a new position

There are two methods for moving (stepping) the antenna to a new position:

- Positioning based on an absolute angle.
- Positioning based on a relative angle.

#### To position using an absolute angle:

1. Click 'Move Antenna - Execute Diagnosis' in the menu options. The move antenna screen appears.
2. Click 'Setup'. The GUI will now enter set up mode.
3. Enter the azimuth (AZ) and elevation (EL) angle values in the corresponding 'Target' boxes of the 'Go to position' box.
4. Click 'Go to Target Position'. The antenna will move to the new target position.

5. Click 'Restart'. The system leaves set up mode and the antenna will start tracking.

#### To position using a relative angle:

1. Click 'Move Antenna - Execute Diagnosis' in the menu options. The move antenna screen appears
2. Click 'Setup'. The GUI will now enter set up mode.
3. Enter the angle that you want the antenna to move in the relevant boxes of the 'Move Step' box. The box marked with up/down arrows will adjust the EL position, the box marked with left/right arrows adjusts the AZ position.
4. Click the arrow corresponding to the direction that you want the antenna to move.
5. Click 'Restart'. The system leaves set up mode and the antenna will start tracking.

### Antenna diagnosis

The antenna diagnosis function, automatically tests the operation of the system and shows its status.

#### To carry out antenna diagnosis:

1. Click 'Move Antenna - Execute Diagnosis' in the menu options. The move antenna screen appears.
2. Click 'Setup'. The GUI will now enter set up mode.
3. Click the 'Diagnosis' button. Antenna diagnosis is automatically carried out.

As each function is tested the result is shown by the circle next to the function title in the diagnosis box changing color.

- Blue - shows the function is operating correctly.
- Green - shows the function is being tested.

- Red - shows that there is a fault with that function.  
If a fault is diagnosed refer to "Troubleshooting" on page 45 for possible solutions.
4. Click 'Restart'. The system leaves set up mode and the antenna will start tracking.

## Setting the skew angle

**Note:** *This section is only applicable to regions with linear polarization.*

If you move to a different geographic location, you may need to adjust the skew angle of the LNB to maximize satellite signal reception. For details of the correct skew angle refer to the local satellite television provider.

The skew angle of the LNB is shown by a circular skew angle guide attached to the LNB.

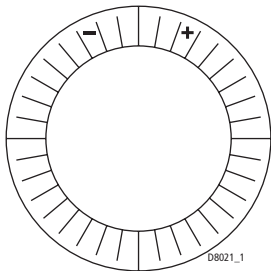

### To adjust the LNB skew angle:

1. Ensure the system is powered OFF.
2. Remove the antenna unit cover.
3. Loosen the four screws securing the LNB in the choke feed.

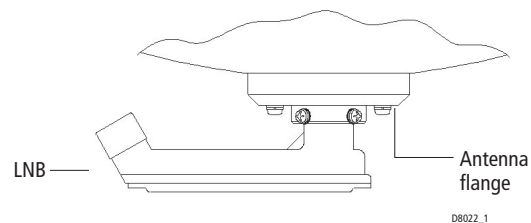

4. Carefully turn the LNB to match the required skew angle as close as possible.
5. Tighten the LNB securing screws.
6. Refit the antenna unit cover.
7. Power the system ON and function test.

**Note:** *Certain Raymarine 60STV Satellite TV systems have automated skew control. These systems will automatically rotate the LNB to maximize reception in your location.*



# Maintenance and troubleshooting

## Introduction

This section deals with maintenance and troubleshooting that can be carried out by the system user.

## Maintenance



### WARNING

#### Power supply

**Ensure that the system is isolated from your boat's power supply before carrying out any maintenance.**

Your Raymarine Satellite TV system has been designed to require minimal maintenance. The following routine maintenance checks will ensure that your system maintains peak performance:

- Examine the cables for signs of damage, such as chafing, cuts or nicks.
- Check that all cables are firmly attached.
- Wash the exterior of the antenna cover with fresh water to remove salt deposits; a mild detergent may be added to remove grime. DO NOT use abrasive cleaners or solvents such as acetone as this may result in irreparable damage to the unit.
- The antenna is not a sealed unit, DO NOT use a power spray to wash the exterior as this may result in water ingress and damage to the unit.
- Twice a year remove the antenna cover and examine the interior for signs of corrosion.

## Troubleshooting

Your Raymarine product has been subjected to comprehensive test and quality assurance programs prior to packing and shipping. However, if your unit should develop a fault, please refer to the following table to identify the most likely cause and the corrective action required to restore normal operation.

If you still have a problem after referring to the table, contact your local Raymarine dealer, national distributor or Raymarine Product Support for further advice.

Symptom	Possible cause*							
	1	2	3	4	5	6	7	8
Antenna not functioning or displays 'ANT OUT OF CONTROL' message	X				X			
No picture on TV set			X		X	X		X
Intermittent picture for short intervals		X	X	X	X	X		X
System works at the dock but not underway		X						
System will not find satellite		X	X	X	X	X	X	X
'Snowy' television picture				X				

**Note:** \* for an explanation of possible causes and their remedies refer to the following paragraphs.

### **1. Blown fuse, low power or wiring**

- Check that the in-line quick blow fuse (if fitted) has not blown, or the circuit breaker has not tripped. Replace fuse with one of the same type and rating.
- If you have extended the power cable from the antenna unit, check that there is no power loss.
- Check the system wiring and connections.

### **2. Satellite signal blocked**

Satellite signals can be blocked or degraded by buildings, other boats, or equipment on your boat. Check that the antenna has a clear view of the sky.

### **3. Outside satellite coverage zone**

Your system will provide excellent reception within the antenna coverage area for your satellite television service. However, signal quality may degrade as you approach the edges of this zone. Refer to "Satellite coverage areas" on page 49 to check the viable coverage area for your antenna.

### **4. Radar interference**

The energy levels radiated by radar units can overload the antenna front-end circuits. Make sure that your antenna is installed as described in "How do I plan the installation?..." on page 10 of this handbook with regards to your radar unit.

### **5. Incorrect or loose RF or power/data connectors**

As part of the regular maintenance recommended by Raymarine, all connections should be checked to ensure that they have not become loose. A loose RF or power/data connector can reduce signal quality or cause the antenna not to work.

### **5. Multi-switch interference**

If you have multiple IRD's connected to your system, make sure that you are using an ACTIVE not PASSIVE multi-switch.

### **7. IRD troubleshooting**

Your IRD may be the cause of less than ideal operation.

1. Check the IRDs configuration to ensure that it is programmed for the area in which you are operating.
2. Unplug the IRD from the power supply for 15 seconds. Reconnect and allow the system to initialize.

### **8. LNB fault**

If you have an LNB fault, it may require replacing. Contact your local dealer, national distributor or Raymarine Product Support for further assistance.

## Antenna diagnosis

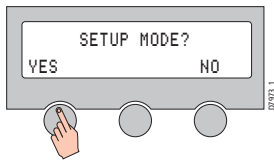

1. Press YES to enter set up mode.

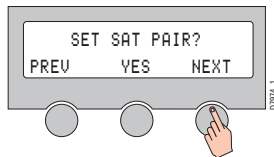

2. Press NEXT 8 times to go to Antenna Diagnosis menu.

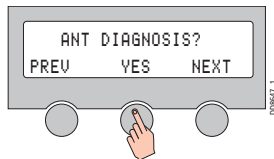

3. Press YES to enter diagnosis mode.



4. Code 101 is being tested.  
Press EXIT to return to main set up menu.

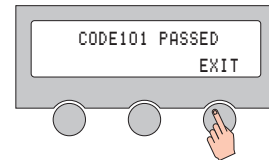

5. Code 101 has been tested and passed.  
Press Exit to return to main set up menu.

### Code Test

- |          |  |
|----------|--|
| Code 101 | Communication between antenna and ACU is being tested.<br>If failed, check the power and data cable connections.         |
| Code 102 | AZ CW (clockwise) limit switch is tested.<br>If failed check the limit switch, motor and belt for azimuth axis.          |
| Code 103 | AZ CCW (counter clockwise) limit switch is tested.<br>If failed check the limit switch, motor and belt for azimuth axis. |
| Code 104 | EL axis is tested.<br>If failed check the limit switch, motor and belt for elevation axis.                               |
| Code 105 | Sub-reflector is tested.<br>If failed, check sub-reflector.  |
| Code 106 | LNB tested.<br>If failed, check the LNB and control board.   |

## Technical support

You can obtain Technical Support for your Raymarine Satellite TV System from the following:

### [www.raymarine.com](http://www.raymarine.com)

---

#### United States

##### **Raymarine Technical Support**

1-800-539-5539 extension 2444, or  
(603) -881-5200

##### **Product Repair and Service**

Raymarine Product Repair Center  
21 Manchester Street,  
Merrimack, NH 03054 - 4801  
1-800-539-5539

Opening hours:  
Monday through Friday 0815 - 1700  
Eastern Standard or Eastern Daylight  
Savings Time.

#### **Help us to help you**

When requesting service, please quote the following product information:  
Equipment type ● Model number ● Serial number

#### Europe

##### **Technical Support**

##### **Services Accessories**

Raymarine UK Limited  
Anchorage Park  
Portsmouth  
PO3 5TD  
England

Tel:  
+44(0)23 9271 4713

Fax:  
+44(0)23 9266 1228

# Satellite information

## Introduction

This section contains information on satellites in your region and includes:

- Satellite coverage areas.
- Satellite coverage by geographic location.
- Satellite tracking information

## Satellite coverage areas

The following satellite coverage maps do not guarantee coverage. This can be affected by climatic conditions that may cause variation in the satellite signal.

## Climatic conditions

Atmospheric conditions that may cause a significant loss of signal level include:

- Rain
- Snow
- Heavy fog
- Solar activity, e.g. sun spot and flare activity.

By far the most common of these conditions is rain. Rain drops in the atmosphere will reduce the signal from the satellite, the heavier the rain the higher the signal loss. The effect of this signal loss is that the antenna's ability to remain locked to the satellite signal becomes severely affected. This in turn means degradation or in some cases a complete loss of satellite signal. When the amount of rain contained in the atmosphere decreases the antenna will re-acquire the satellite signal.

## European satellites

### Astra 1G/1H

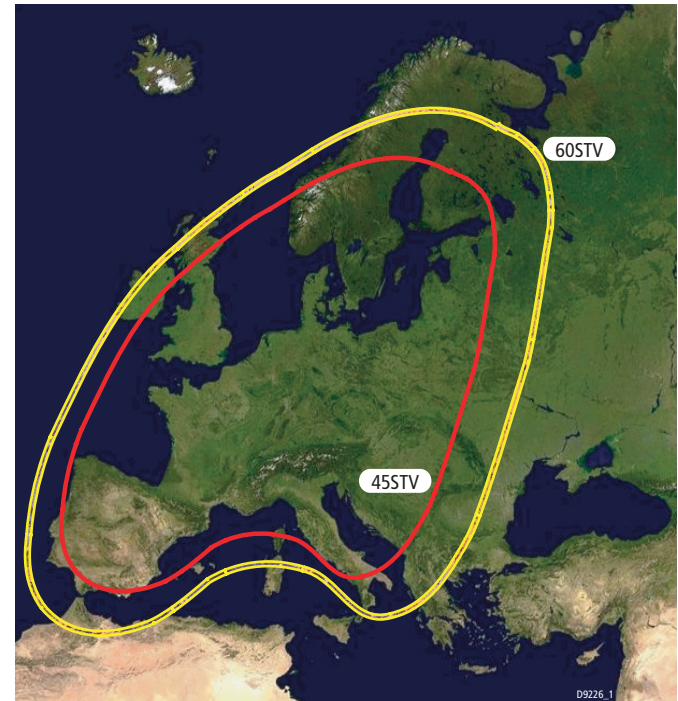

## Astra 2A South

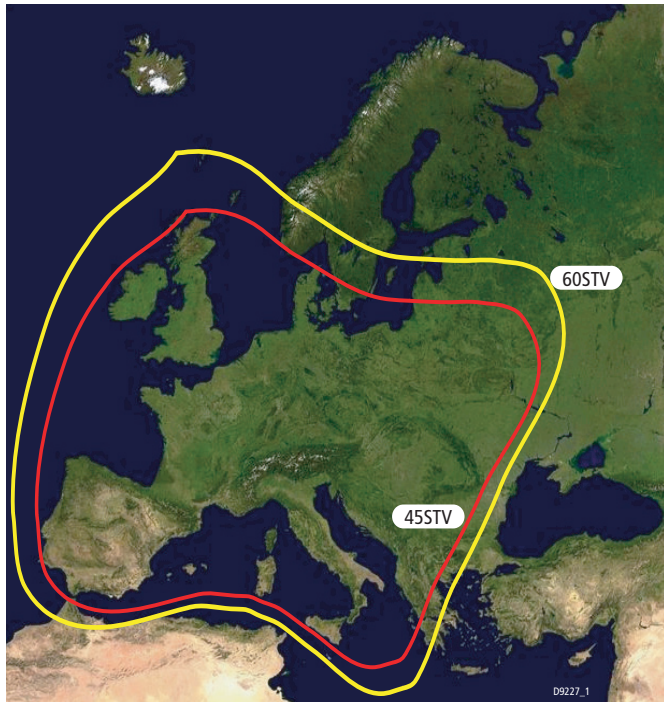

## Hotbird

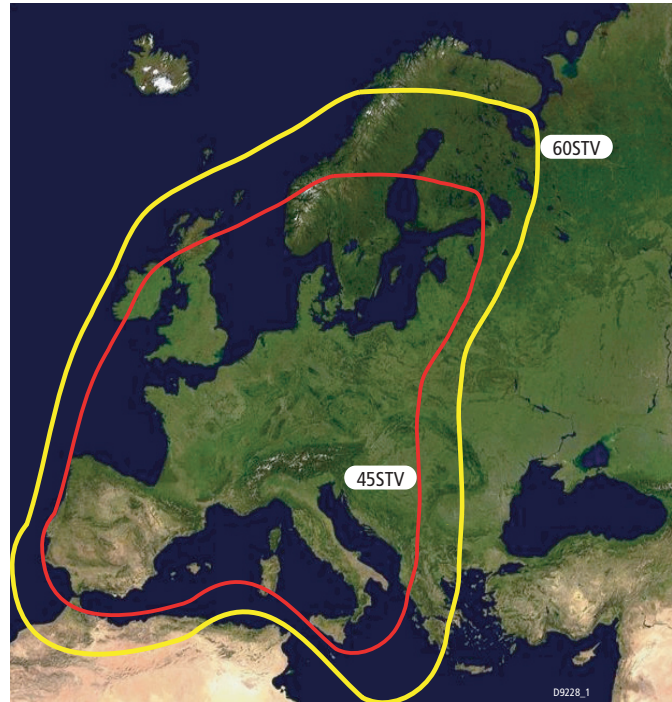

## Hotbird Widebeam

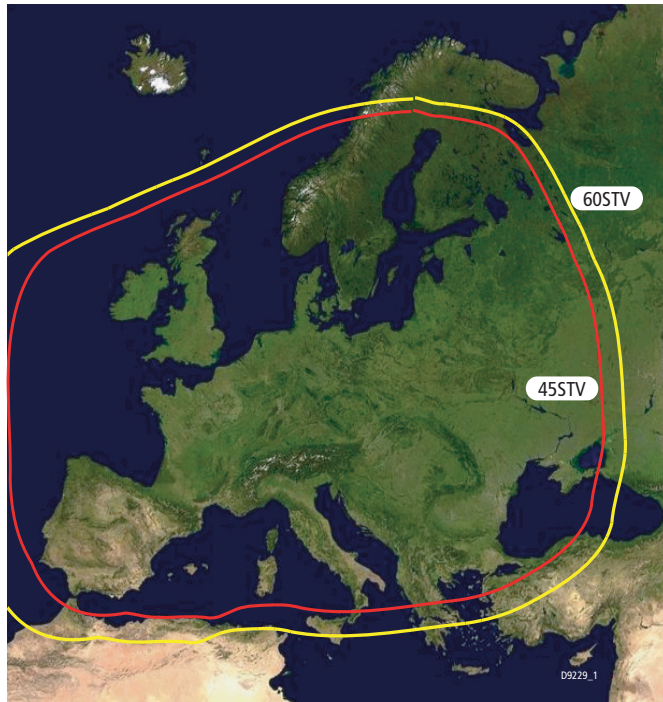

## Hispasat

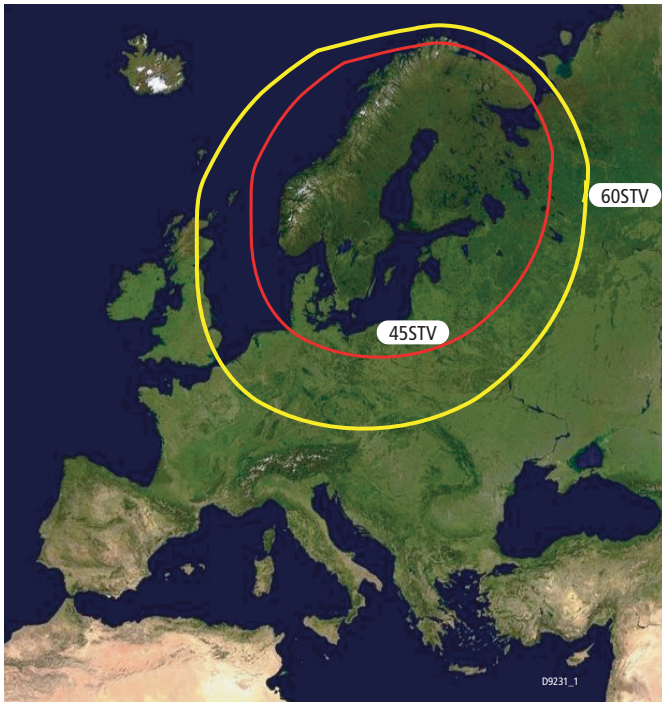
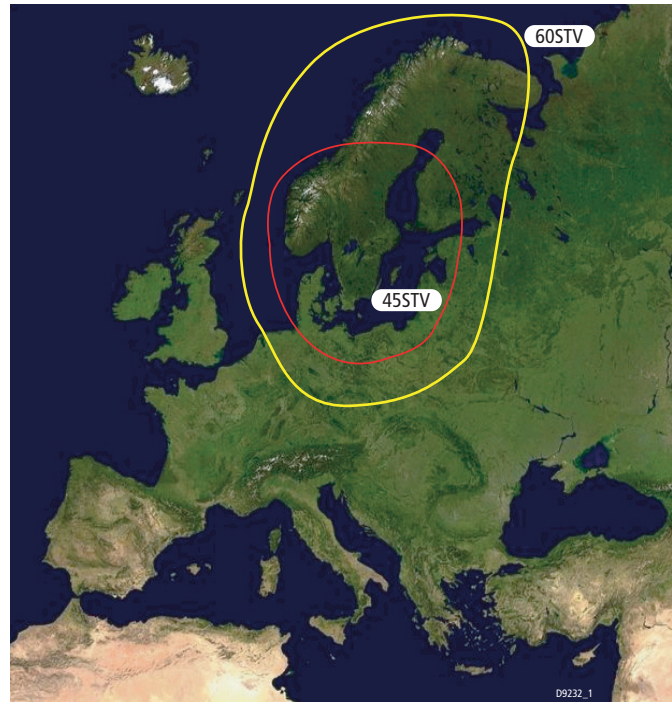

**Thor II****Sirius**



## US satellites

### Direct TV

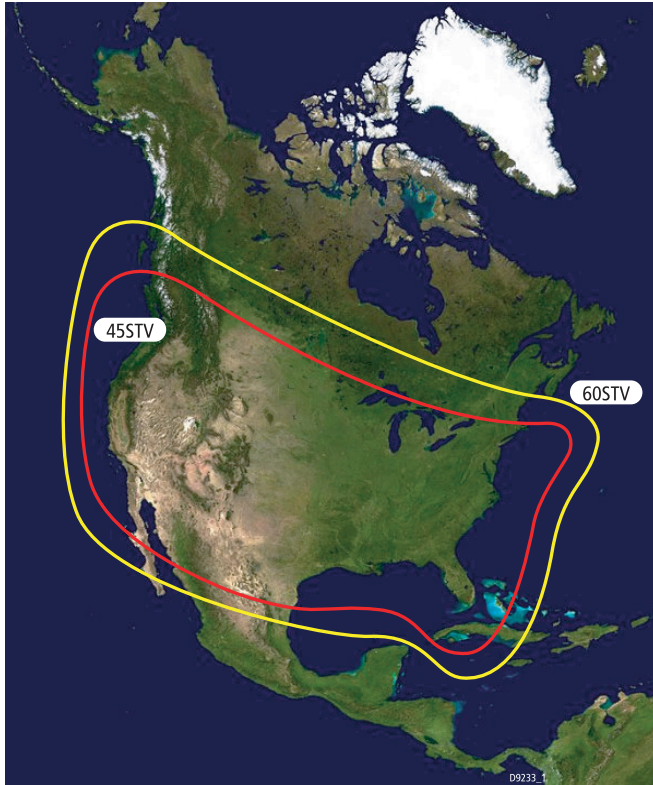

### Dish Network

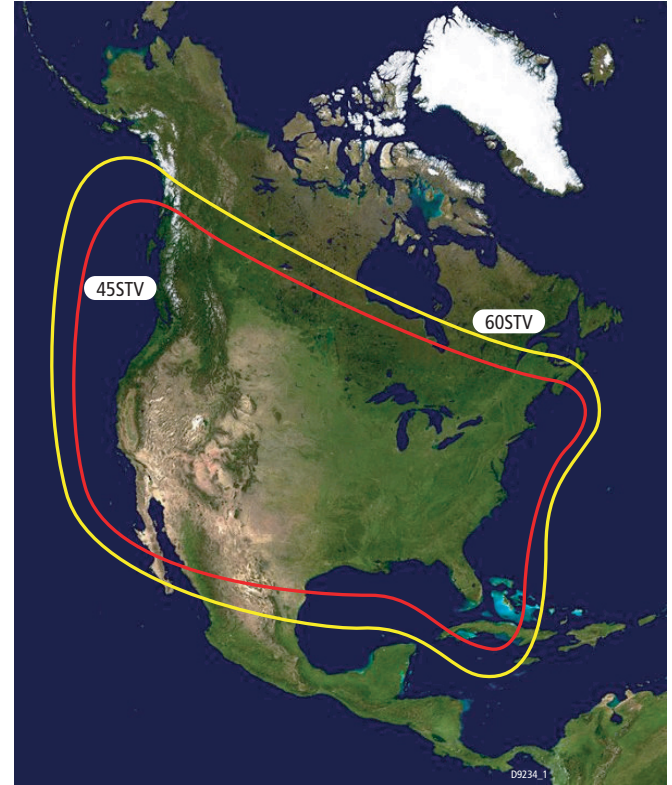

## ExpressVu

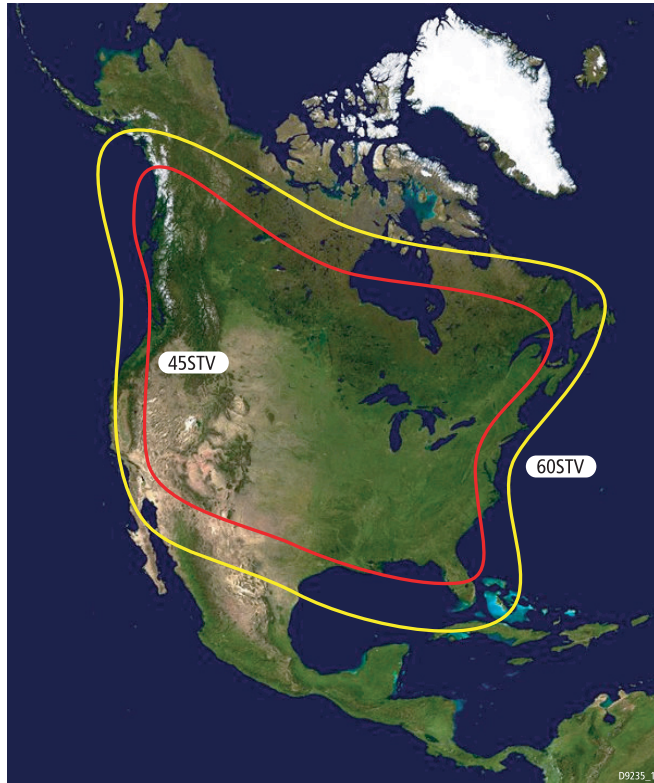

## Mexico

### Panamsat 9 (Sky)



## Australia

### Optus C1

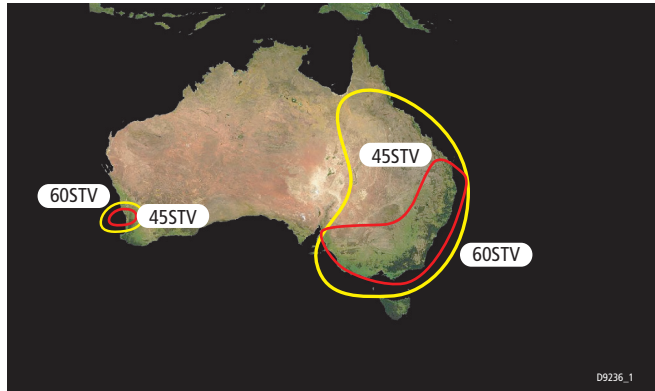

## New Zealand

### Optus B1



## Far East

### Telstar

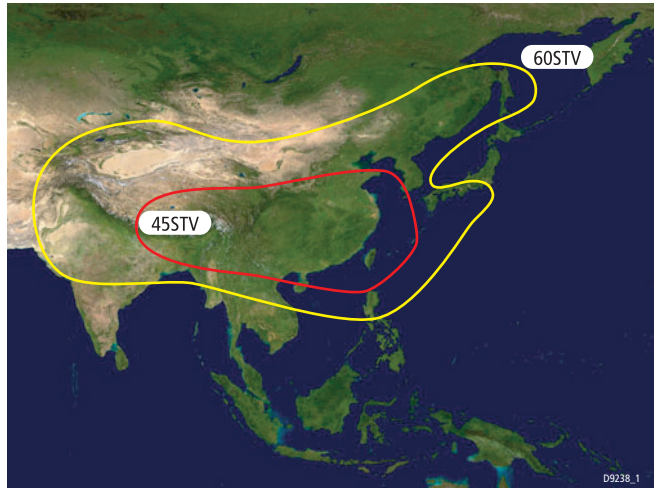

### Agila2

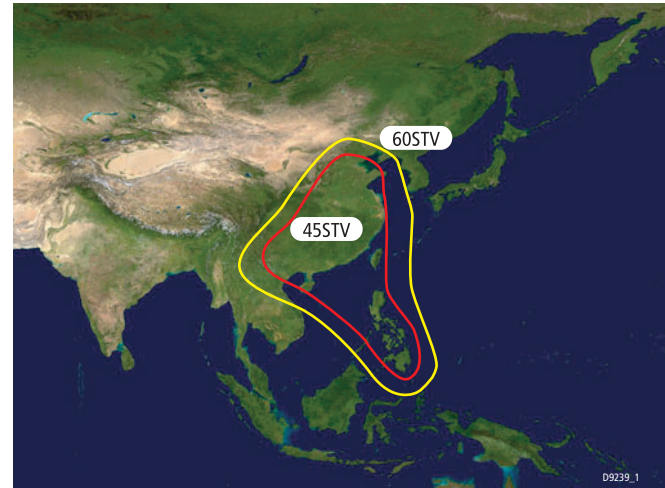

## Middle East

### Nilesat



### Arabsat

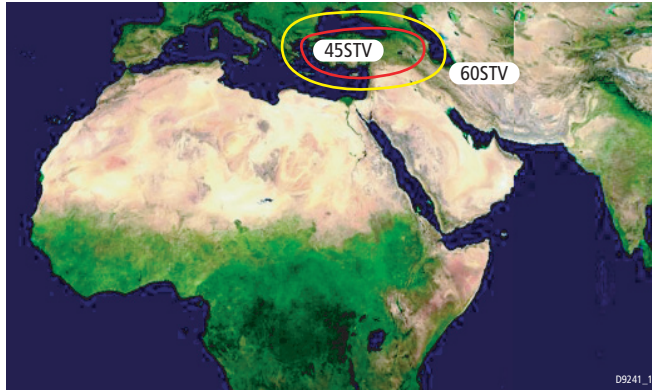

**Turksat**

## South America

### Galaxy 3C- South America (DirecTV)



### Panamsat 6- South America (Sky)



## Satellite coverage by geographic location

The following table details satellite coverage by geographic location. To receive a satellite television service you will need to subscribe to the service from the relevant service provider.

### Europe

Country	Satellites	Service provider
England	Astra - AST 02AS0 Astra - AST02AN0	Astra <a href="http://www.ses-astra.com">www.ses-astra.com</a>
Germany	Primary: Astra - AST01GKU  Secondary (limited channels): Hotbird - HOT234KW Astra - AST01EH1 Astra - AST01FH1 Astra - AST01EV1	Astra <a href="http://www.ses-astra.com">www.ses-astra.com</a>  Hotbird <a href="http://www.eutelsat.com">www.eutelsat.com</a>
France	Hotbird - HOT234KS Hotbird - HOT234KW Astra - AST101GKU	Astra <a href="http://www.ses-astra.com">www.ses-astra.com</a>  Hotbird <a href="http://www.eutelsat.com">www.eutelsat.com</a>

Country	Satellites	Service provider
Spain	Primary: Astra - AST01GKU  Secondary (limited channels): Hispasat - HIS01AKS Hispasat - HI01CKS Hotbird - HOT234KW Astra - AST01EV1	Hispasat <a href="http://www.hispasat.com">www.hispasat.com</a>  Astra <a href="http://www.ses-astra.com">www.ses-astra.com</a>  Hotbird <a href="http://www.eutelsat.com">www.eutelsat.com</a>
Italy	Hotbird - HOT234KS Hotbird - HOT234KW	Hotbird <a href="http://www.eutelsat.com">www.eutelsat.com</a>
Scandinavia	Primary: Sirius - SIR002KN Thor - THO002KU  Secondary (limited channels): Sirius - SIR003KN Thor - THO001KU Thor - THO003KU	Sirius <a href="http://www.nsab.se">www.nsab.se</a>  Thor <a href="http://www.telenor.com">www.telenor.com</a>



Country	Satellites	Service provider		
Turkey	Hotbird - HOT234KW	Hotbird	EchoStar 3 - ECH003KB	EchoStar Communications Corp.
	Turksat - TUR01BKT	<a href="http://www.eutelsat.com">www.eutelsat.com</a>	EchoStar 6.8 - ECH008KB	<a href="http://www.dishnetwork.com">www.dishnetwork.com</a>
	Turksat - TUR01CEB	Turksat	EchoStar 7 - ECH007KB	
		<a href="http://www.satcom.gov.tr">www.satcom.gov.tr</a>	EchoStar 1.2 - ECH001KB	
Russia	Thor - TH0003KU	Thor	DIRECTV 2.3 - DTV123KB	DirectV Inc.
	Hotbird - HOT234KW	<a href="http://www.telenor.com">www.telenor.com</a>	DIRECTV 6 - DTV006KB	<a href="http://www.directv.com">www.directv.com</a>
		Hotbird		
		<a href="http://www.eutelsat.com">www.eutelsat.com</a>		
Greece	Hotbird - HOT234KW	Hotbird		
		<a href="http://www.eutelsat.com">www.eutelsat.com</a>		

## United States

Satellite	Service provider
NIMIQ1 - NIM001KB	Bell ExpressVu
NIMIQ2 - NIM002KB	<a href="http://www.expressvu.com">www.expressvu.com</a>

## Satellite tracking

Your Raymarine Satellite TV System can track a variety of DVB compatible and DSS (DIRECTV) satellites. Your system contains a pre-programmed library of either European or North American satellites, whichever are applicable to your system. There are also two open slots which can be programmed with user defined satellites.

## European satellites

## Satellite service providers

The tables on the following pages contain the information that is required to manually enter data for both European and North American satellites.

Satellite name	Frequency	Transponder symbol rate	FEC code	Satellite network ID	LNB polarization (vertical or horizontal)	LNB band	Decoding type
Astra 1	10788	22000	5/6	0x0001	V	L	DVB
	10773	22000	5/6	0x0001	H	L	DVB
	11895	27500	3/4	0x0001	V	H	DVB
	12032	27500	3/4	0x0085	H	H	DVB
Astra 2	10788	22000	5/6	0x0020	V	L	DVB
	10733	22000	5/6	0x0020	H	L	DVB
	11895	27500	2/3	0x0020	V	H	DVB
	11954	27500	2/3	0x0020	H	H	DVB
Hispasat	11771	27500	3/4	0x0031	V	L	DVB
	11811	27500	3/4	0x0036	H	L	DVB
	12303	27500	3/4	0x0031	V	H	DVB
	11851	27500	3/4	0x0036	H	H	DVB
Hotbird	11623	27500	3/4	0x013E	V	L	DVB
	11642	27500	3/4	0x013E	H	L	DVB
	11958	27500	3/4	0xFBFF	V	H	DVB
	11977	27500	3/4	0xFBFF	H	H	DVB

Satellite name	Frequency	Transponder symbol rate	FEC code	Satellite network ID	LNB polarization (vertical or horizontal)	LNB band	Decoding type
Sirius	11747	27500	3/4	0x0056	V	L	DVB
	11804	27500	3/4	0x0056	H	L	DVB
	12054	27500	3/4	0x0056	V	H	DVB
	12034	27500	3/4	0x0056	H	H	DVB
Thor	11216	24500	7/8	0x0046	V	L	DVB
	11229	24500	7/8	0x0046	H	L	DVB
	12456	28000	3/4	0x0046	V	H	DVB
	12476	28000	3/4	0x0046	H	H	DVB
Arabsat	11747	27500	3/4	0x02BE	V	H	DVB
	11662	27500	3/4	0x002C	V	L	DVB
	11843	27500	3/4	0x02BE	H	H	DVB
	11642	27500	3/4	0x02BE	H	L	DVB
Nilesat	11900	27500	3/4	0x0800	V	H	DVB
	00000	27500	3/4	0x0000	V	L	DVB
	11996	27500	3/4	0x0800	H	H	DVB
	00000	27500	3/4	0x0000	H	L	DVB
Turksat	11804	24444	5/6	0x0042	V	H	DVB
	11804	24444	5/6	0x0042	V	L	DVB
	11892	12800	5/6	0x0049	H	H	DVB
	11892	12800	5/6	0x0049	H	L	DVB

## North American satellites

Satellite name	Frequency	Transponder symbol rate	FEC code	Satellite network ID	LNB polarization (vertical or horizontal)	LNB band	Decoding type
ExpressVu91	12428	20000	5/6	0X0100	RHCP	U	DVB
	12443	20000	5/6	0X0100	LHCP	U	DVB
ExpressVu82	12428	20000	5/6	0X0101	RHCP	U	DVB
	12443	20000	5/6	0X0101	LHCP	U	DVB
EchoStar61	12632	20000	3/4	0X1002	RHCP	U	DVB
	12443	20000	5/6	0X1002	LHCP	U	DVB
EchoStar 110	12428	20000	5/6	0X1006	RHCP	U	DVB
	12443	20000	5/6	0X1006	LHCP	U	DVB
EchoStar 119	12428	20000	5/6	0X1004	RHCP	U	DVB
	12443	20000	5/6	0X1004	LHCP	U	DVB
EchoStar 148	12428	20000	5/6	0X1009	RHCP	U	DVB
	12443	20000	5/6	0X1009	LHCP	U	DVB
DirecTV73	12370	20000	2/3	0XFFF7	RHCP	U	DSS
	12355	20000	2/3	0XFFF7	LHCP	U	DSS
DirecTV 101	12428	20000	6/7	0XFFF0	RHCP	U	DSS
	12443	20000	6/7	0XFFF0	LHCP	U	DSS
DirecTV 119	12428	20000	5/6	0X1004	RHCP	U	DVB
	12443	20000	5/6	0X1004	LHCP	U	DVB

## Australia and New Zealand

Satellite name	Frequency	Transponder symbol rate	FEC code	Satellite network ID	LNB polarization (vertical or horizontal)	LNB band	Decoding type
Optus B1	12608	22500	3/4	0x00B6	V	U	DVB
	12456	22500	3/4	0x00B6	H	U	DVB
Optus C1	12447	27800	3/4	0x1000	V	U	DVB
	12358	27800	3/4	0x1000	H	U	DVB

## Far East

Satellite name	Frequency	Transponder symbol rate	FEC code	Satellite network ID	LNB polarization (vertical or horizontal)	LNB band	Decoding type
Agila2	12301	25600	5/6	0x0039	H	L	DVB
Telstar 10	12528	30000	3/4	0x0001	V	U	DVB
	12551	13338	3/4	0x0001	H	U	DVB
Telstar 18	12538	41250	1/2	0x0378	V	H	DVB



## Appendix 7: Technical specification

### Raymarine 45 STV

General		Antenna system performance	
Approvals CE - conforms to FCC- verified to	EU Directive 89/336/EEC CFR47: Part 15	Frequency	Ku-band (10.7 to 12.75 GHz)
Dimensions Satellite antenna unit Antenna dish diameter Antenna control unit	500 mm x 538 mm (19.7 x 21.2 ins.) 450 mm (18 ins.) 195 mm x 225 mm x 65 mm (7.6 x 8.8 x 2.5 ins).	Antenna gain	33dBi @ 12.25 GHz
Weight Satellite antenna unit Antenna control unit	14 kg (31 lbs.) 1.7 kg (3.5 lbs)	Minimum EIRP	50 dBW
Environmental Operating temperature range Storage temperature range Humidity limit	-10°C to + 55°C (-14°F to 130°F) -20°C to + 70°C (-4°F to 158°F) 95% R.H	Azimuth range	680°
Operating voltage	10.8 - 15.6 V DC	Elevation range	0° ~ +90°
Power consumption	2A (30 W typical)	Roll and pitch range	Roll - ± 25° Pitch - ± 15°
		Roll and pitch tracking	50° per second
		Roll and pitch rate	50° per second
		Universal Twin LNBF	
		RF input frequency range	10.7 -- 11.70 GHz - Low band 11.7 - 12.75 GHz - High band
		IF output frequency range	950 - 1950 MHz - Low band 1100 - 1250 MHz - High band

**Universal Twin LNBF**

Local oscillator frequency	9.75 GHz - Low band 10.6 GHz - High band
Local oscillator frequency stability	$\pm 1.0$ MHz @ 25°C $\pm 2.0$ MHz @ -40°C ~ 60°C
Local oscillator phase noise	-50 dBc/Hz @ 1 KHz maximum -75 dBc/Hz @ 10 KHz maximum -95 dBc/Hz @ 100 KHz maximum
Gain flatness	$\pm 0.5$ dB/ 26 MHz
Cross polarization isolation	20 dB(min)
Image rejection	40 dBm
Output in band spurious	-60 dBm (max)
Output VWSR	2.5:1 (max)
Noise figure	0.6 dB typical - Low band 0.7 dB typical - High band
Output connector type	75 Ohm F-type female connector (2 port)
Polarization switching voltage	10.5 V ~ 14.0 V @ vertical polarization 16.0 V ~ 19.0 V @ horizontal polarization

**Universal Twin LNBF**

DC current consumption	160 mA (max)
Band switching signal (DiSEqC 1.0 interface)	0 Hz - Low band 22 KHz $\pm$ 4 KHz - High band
Operating temperature range	-40°C ~ +60°C
Storage temperature range	-40°C ~ +80°C
Polarization modes	Linear vertical and horizontal

**Dual LNBF**

RF input frequency range	12.1 ~ 12.7 GHz
IF output frequency range	950 ~ 1450 MHz
Local oscillator frequency stability	11250 $\pm$ 4 MHz (max) over temperature and life
Local oscillator jump @ 13/18 V switching	2.5 KHz (max)
Local oscillator phase noise	-50 dBc/Hz @ 1 KHz maximum -75 dBc/Hz @ 10 KHz maximum -95 dBc/Hz @ 100 KHz maximum
Conversion gain	50 ~ 62 dB
Gain flatness	1 dB (max) @ 24 MHz intervals



---

**Dual LNBF**

---

Gain variation	5 dB (max) across 500 MHz
Cross polarization isolation	25 dB (min.)
Image rejection	40 dBm (min.)
Output VWSR	2.1(max) in a 75 W system
Noise figure	1.1 dB (max)
Po 1 dB	0 dBm (min.)
3 <sup>rd</sup> order intermodulation	-50 dBc (max), two tones of -15 dBm output spaced 27 MHz
Polarization switching voltage	10.5 V ~ 14.0 V @ RHCP 15.0 V ~ 21.0 V @ LHCP
DC current consumption	180 mA (max)
Operating temperature range	-40°C ~ +60°C
Storage temperature range	-40°C ~ +80°C
Waterproof	Air pressure @ 0.2 kg/cm <sup>2</sup>

---

## Raymarine 60 STV

### General

Approvals CE - conforms to FCC- verified to	EU Directive 89/336/EEC CFR47: Part 15
---	---

Dimensions	
Satellite antenna unit	698mm x 719 mm (27.5 x 28.3 ins)
Antenna dish diameter	60 cm (24 ins)
Antenna control unit	195 mm x 225 mm x 65 mm (7.6 x 8.8 x 2.5 ins)

Weight	
Satellite antenna unit	20 kg (44 lbs)
Antenna control unit	1.7 kg (3.5 lbs)

Environmental	
Operating temperature range	-10°C to + 55°C (-14°F to 130°F)
Storage temperature range	-20°C to + 70°C (-4°F to 158°F)
Humidity limit	95% R.H

Operating voltage	10.8 - 15.6 V DC
-------------------	------------------

Power consumption	
-------------------	--

### Antenna system performance

Frequency	Ku-band (10.7 to 12.75 GHz)
-----------	-----------------------------

Antenna gain	36 dBi
--------------	--------

Minimum EIRP	47 dBW
--------------	--------

Azimuth range	680°
---------------	------

Elevation range	5° to 90°
-----------------	-----------

Roll and pitch range	Roll - $\pm 25^\circ$ Pitch - $\pm 15^\circ$
----------------------	---

Roll and pitch tracking	45 per second
-------------------------	---------------

Roll and pitch rate	45° per second
---------------------	----------------

### Universal Twin LNBF

RF input frequency range	10.7 ~ 11.7 GHz - Low band 11.7 ~ 12.75 GHz - High band
--------------------------	--

IF output frequency range	950 ~ 1950 MHz - Low band 1100 ~ 2150 MHz - High band
---------------------------	--

Local oscillator frequency	9.75 GHz - Low band 10.6 GHz - High band
----------------------------	---

**Universal Twin LNBF**

Local oscillator frequency stability	$\pm 1.0$ MHz @ 25°C $\pm 2.0$ MHz @ -40°C ~ 60°C
Local oscillator phase noise	-50 dBc/Hz @ 1 kHz -75 dBc/Hz @ 10 kHz -95 dBc/Hz @ 100 kHz
Conversion gain	50 dB (min), 60 dB (max)
Gain flatness	$\pm 0.5$ dB/26 MHz
Cross polarization isolation	20 dB (min)
Image rejection	40 dB (min)
Output in band spurious	
Output VWSR	2.5:1 (max)
Noise figure	0.8 dB typical - Low band 0.7 dB typical - High band
Output connector type	75 Ohm F-type female
Polarization switching voltage	10.5 V ~ 14.0 V @ VP 16.0 V ~ 19.0 V @ HP
DC current consumption	160 mA (max)
Band switching signal (DiSEqC 1.0 interface)	0 kHz - Low band 22 kHz $\pm$ 4 kHz - High band

**Universal Twin LNBF**

Operating temperature range	-40°C ~ +60°C
Storage temperature range	-40°C ~ +80°C
Polarization modes	Linear vertical and horizontal

**Dual LNBF (US models)**

RF input frequency range	12.1 ~ 12.7 GHz
IF output frequency range	950 ~ 1450 MHz
Local oscillator frequency stability	11250 $\pm$ 4 MHz (max) over temperature and life
Local oscillator jump @ 13/18 V switching	2.5 KHz (max)
Local oscillator phase noise	-50 dBc/Hz @ 1 KHz maximum -75 dBc/Hz @ 10 KHz maximum -95 dBc/Hz @ 100 KHz maximum
Conversion gain	50 ~ 62 dB
Gain flatness	1 dB (max) @ 24 MHz intervals
Gain variation	5 dB (max) across 500 MHz
Cross polarization isolation	25 dB (min.)

**Dual LNBF (US models)**

Image rejection	40 dBm (min.)
Output VWSR	2.1(max) in a 75 W system
Noise figure	1.1 dB (max)
Po 1 dB	0 dBm (min.)
3 <sup>rd</sup> order intermodulation	-50 dBc (max), two tones of -15 dBm output spaced 27 MHz
Polarization switching voltage	10.5 V ~ 14.0 V @ RHCP 15.0 V ~ 21.0 V @ LHCP
DC current consumption	180 mA (max)
Operating temperature range	-40°C ~ +60°C
Storage temperature range	-40°C ~ +80°C
Waterproof	Air pressure @ 0.2 kg/cm <sup>2</sup>

**QuadLNBF (EU Premium models)**

RF input frequency range	10.7 ~ 11.7 GHz - Low band 11.7 ~ 12.75 GHz - High band
IF output frequency range	950 ~ 1950 MHz - Low band 1100 ~ 2150 MHz - High band
Local oscillator frequency	9.75 GHz - Low band 10.6 GHz - High band
Local oscillator frequency stability	± 1.0 MHz @ 25°C ± 2.0 MHz @ -40°C ~ 60°C
Local oscillator phase noise	-50 dBc/Hz @ 1 kHz -75 dBc/Hz @ 10 kHz -95 dBc/Hz @ 100 kHz
Gain flatness	± 0.5 dB/26 MHz
Cross polarization isolation	20 dB (min)
Image rejection	40 dB (min)
Output in band spurious	-60 dBm (max)
Output VWSR	2.5:1 (max)
Noise figure	0.8 dB typical - Low band 0.7 dB typical - High band
Output connector type	75 Ohm F-type female (4 port)

---

**QuadLNBF (EU Premium models)**

---

Polarization switching voltage	10.5 V ~ 14.0 V @ VP 16.0 V ~ 19.0 V @ HP
DC current consumption	160 mA (max)
Band switching signal (DiSEqC 1.0 interface)	0 kHz - Low band 22 kHz $\pm$ 4 kHz - High band
Operating temperature range	-40° C ~ +60° C
Storage temperature range	-40° C ~ +80° C
Polarization modes	Linear vertical and horizontal

---



## Free Manuals Download Website

<http://myh66.com>

<http://usermanuals.us>

<http://www.somanuals.com>

<http://www.4manuals.cc>

<http://www.manual-lib.com>

<http://www.404manual.com>

<http://www.luxmanual.com>

<http://aubethermostatmanual.com>

Golf course search by state

<http://golfingnear.com>

Email search by domain

<http://emailbydomain.com>

Auto manuals search

<http://auto.somanuals.com>

TV manuals search

<http://tv.somanuals.com>