



# DIRT QUAD



## OWNER'S MANUAL

**Read and understand this entire manual before using!  
For assistance contact Razor. DO NOT RETURN TO STORE.**

**NOTE: Manual illustrations are for demonstration purposes only.  
Illustrations may not reflect exact appearance of actual product.  
Specifications subject to change without notice.**

# CONTENTS

Safety Warnings .....	1	Troubleshooting Guide .....	7
Before You Begin.....	2	Dirt Quad Parts List .....	8
Assembly and Set-Up.....	3	Safety Reminders .....	10
Before Riding.....	4	Warranty Information.....	10
Repair and Maintenance.....	4-6		

# SAFETY WARNINGS

**⚠ WARNING:** Riding an electric four wheeler can be a hazardous activity. Certain conditions may cause the equipment to fail without fault of the manufacturer. Like other electric products, the Dirt Quad can and is intended to move, and it is therefore possible to lose control, fall off and/or get into dangerous situations that no amount of care, instruction or expertise can eliminate. If such things occur you can be seriously injured or die, even when using safety equipment and other precautions. **RIDE AT YOUR OWN RISK AND USE COMMON SENSE.**

This manual contains many warnings and cautions concerning the consequences of failing to maintain, inspect or properly use your electric four wheeler. Because any incident can result in serious injury or even death, we do not repeat the warning of possible serious injury or death each time such a possibility is mentioned.

## APPROPRIATE RIDER USE AND PARENTAL SUPERVISION

This manual contains important safety information. It is your responsibility to review this information and make sure that all riders understand all warnings, cautions, instructions and safety topics and assure that young riders are able to safely and responsibly use this product. Razor USA recommends that you periodically review and reinforce the information in this manual with younger riders, and that you inspect and maintain your children's Dirt Quad to insure their safety.

The recommended rider age of 8 years is only an estimate, and can be affected by the rider's size, weight or skills. Any rider unable to fit comfortably on the Dirt Quad should not attempt to ride it.

**A parent's decision to allow his or her child to ride this product should be based on the child's maturity, skill and ability to follow rules.**

Keep this product away from small children and remember that this product is intended for use only by persons who are, at a minimum, completely comfortable and competent while operating the product.

DO NOT EXCEED THE WEIGHT LIMIT OF 120 pounds. Rider weight does not necessarily mean a person's size is appropriate to fit or maintain control of the Dirt Quad.

Do not touch the brakes or electric motor on your electric four wheeler when in use and/or immediately after riding as they can become very hot.

Refer to the following section on safety for additional warnings.

## ACCEPTABLE RIDING PRACTICES AND CONDITIONS

**Always check and obey any local laws or regulations which may affect the locations where the Dirt Quad may be used.**

Ride defensively. Watch out for potential obstacles that could catch your wheel or force you to swerve suddenly or lose control. Be careful to avoid pedestrians, skaters, skateboards, scooters, bikes, children or animals who may enter your path, and respect the rights and property of others.

The Dirt Quad is meant to be used on private property and on closed courses and not on public streets or sidewalks. Do not ride your electric four wheeler in any areas where pedestrian or vehicle traffic is present.

Do not activate the speed control on the hand grip unless you are on the electric four wheeler and in a safe, outdoor environment suitable for riding.

This product was manufactured for performance and durability but are not impervious to damage. Jumping or other aggressive riding can over-stress and damage any product, including the Dirt Quad, and the rider assumes all risks associated with high-stress activity.

Be careful and know your limitations. Risk of injury increases as the degree of riding difficulty increases. The rider assumes all risk associated with aggressive riding activities.

Maintain a hold on the handlebars at all times.

Never carry passengers or allow more than one person at a time to ride the electric four wheeler.

Never use near steps or swimming pools.

Keep your fingers and other body parts away from the drive chain, steering system, wheels and all other moving components.

Never use headphones or a cell phone when riding.

Never hitch a ride with another product.

Do not ride the Dirt Quad in wet or icy weather and never immerse the electric four wheeler in water, as the electrical and drive components could be damaged by water or create other possible unsafe conditions.

Wet, slick, bumpy, uneven or rough surfaces may increase risks of use. Do not ride the electric four wheeler in mud, ice, puddles or water. Avoid excessive speeds that can be associated with downhill rides. Never risk damaging surfaces such as carpet or flooring by use of an electric four wheeler indoors.

Do not ride at night or when visibility is limited.

## PROPER RIDING ATTIRE

Always wear proper protective equipment such as an approved safety helmet (with chin strap securely buckled), elbow pads and kneepads. A helmet may be legally required by local law or regulation in your area. A long-sleeved shirt, long pants and gloves are recommended. Always wear athletic shoes (lace-up shoes with rubber soles), never ride barefooted or in sandals, and keep shoelaces tied and out of the way of the wheels, motor and drive system.

## USING THE CHARGER

The charger supplied with the electric four wheeler should be regularly examined for damage to the cord, plug, enclosure and other parts, and in the event of such damage, the four wheeler must not be charged until the charger has been repaired or replaced.

Use only with the recommended charger.

Use caution when charging.

The charger is not a toy. Charger should be operated by an adult.

Do not operate charger near flammable materials.

Unplug charger and disconnect from scooter when not in use.

Always disconnect from the charger prior to wiping down and cleaning your scooter with liquid.

**FAILURE TO USE COMMON SENSE AND HEED THE ABOVE WARNINGS INCREASES RISK OF SERIOUS INJURY. USE WITH APPROPRIATE CAUTION AND SERIOUS ATTENTION TO SAFE OPERATION.**

## BEFORE YOU BEGIN

Remove contents from box. Remove the foam separators that protect the components from damage during shipping. Inspect the contents of the box for scratches in the paint, dents or kinked cables that may have occurred during shipping. Because the Dirt Quad is 95 percent assembled and packed at the factory, there should not be any problems, even if the box has a few scars or dents.

**MAKE SURE POWER SWITCH IS TURNED "OFF" BEFORE CONDUCTING ANY MAINTENANCE PROCEDURES.**

### Estimated Assembly and Set-Up Time

Razor recommends assembly by an adult.

Allow up to 20 minutes for assembly, not including initial charge time.

Allow up to 12 hours for initial charge (see page 4 for charging information).

**WARNING:**  
DO NOT USE NON-RAZOR PRODUCTS WITH YOUR RAZOR DIRT QUAD. The Dirt Quad has been built to certain Razor design specifications. The original equipment supplied at the time of sale was selected on the basis of its compatibility with the frame, fork and all other parts. Certain aftermarket products may or may not be compatible and may void your warranty.

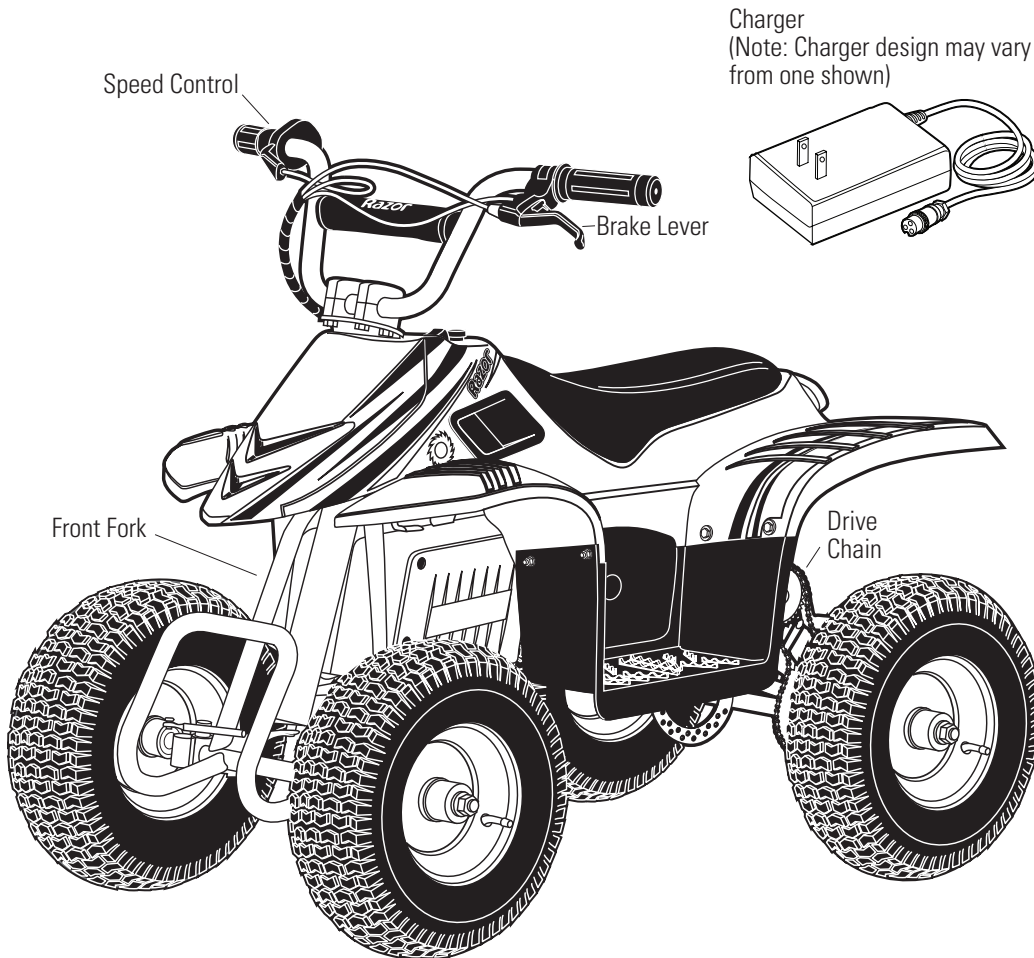

### Required Tools

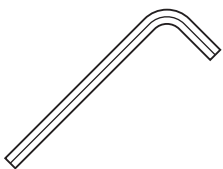

3mm, 5mm and 6mm  
Allen wrenches  
(included)

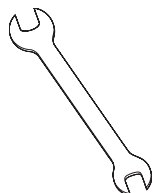

8mm and 10mm open  
wrench  
(included)

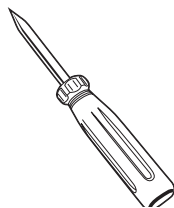

Phillips  
screwdriver  
(included)

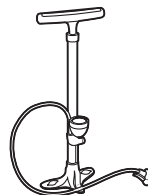

*Bicycle tire pump for  
Schrader valves, with  
pressure gauge  
(Not Included)*

**Need Help?** Visit our website for replacement parts, product support and a list of authorized service centers at [www.razor.com](http://www.razor.com) or call toll-free at 866-467-2967 Monday - Friday 8:00 AM - 5:00 PM Pacific Time.

## ASSEMBLY AND SET-UP

### □ Attaching the Handlebars

**Tools required:** 6mm Allen wrench

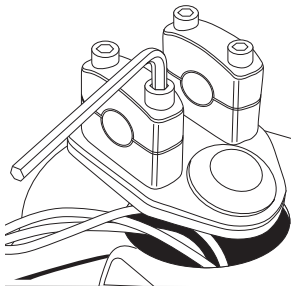

**1** Using the 6mm Allen wrench, remove bolts from handlebar clamp.

**Note:** Handlebar clamps are located in the plastic bag with owner's manual and charger.

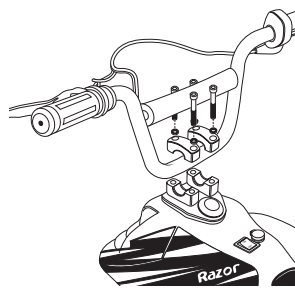

**2** Place handlebars in handlebar clamp in upright, vertical position.

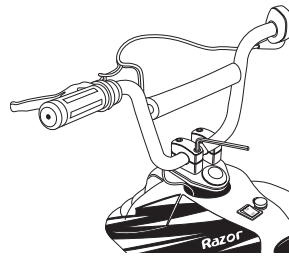

**3** Insert bolts and tighten securely. When properly tightened, the handlebars should not move forward or back.

**Note:** The gap between the upper clamp and lower clamp should be equal on both sides of handlebar.

### ⚠ **WARNING:**

Failing to properly adjust and tighten the bolts that affix the handlebars can cause you to lose control and crash.

### □ Inflating the Tires

Tires are inflated when shipped, but they invariably lose some pressure between the point of manufacturing and your purchase. **Inflate the tires to the correct PSI before first time use.**

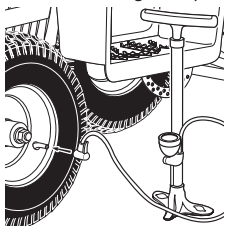

Using a bicycle tire pump equipped for a Schrader valve, inflate the tires to the PSI indicated on the sidewall of the tire.

**Note:** The pressurized air supplies found at gasoline stations are designed to inflate high-volume automobile tires. If you decide to use such an air supply to inflate your tires, first make sure the pressure gauge is working, then use very short bursts to inflate to the correct PSI. If you inadvertently over-inflate the tire, release the excess pressure immediately.

### □ Testing the Brake

To use the brake, squeeze the lever to increase the pressure on the brake. The brake lever is fitted with a cable adjuster to compensate for cable stretch and/or to fine-tune the lever movement to brake engagement. If brake is not engaging properly, follow instructions for adjusting the brakes outlined below.

**Need Help?** Visit our website for replacement parts, product support and a list of authorized service centers at [www.razor.com](http://www.razor.com) or call toll-free at 866-467-2967 Monday - Friday 8:00 AM - 5:00 PM Pacific Time.

## BEFORE RIDING

### □ Charging the Battery

Your electric four wheeler may not have a fully charged battery; therefore it is a good idea to charge the battery prior to use.

- Initial charge time: 12 hours
- Recharge time: up to 12 hours, depending on level of depletion.
- Fully charge battery before storing.
- When the scooter is not in regular use, recharge the battery at least once a month until normal use is resumed.
- Run time: Up to 40 minutes of continuous ride time. Run time may vary depending on riding conditions, climate and/or proper maintenance.
- Average battery life: 250 charge/discharge cycles
- To ensure long battery life, do not store the battery in temperatures above 75° or below -10° F.

Charger

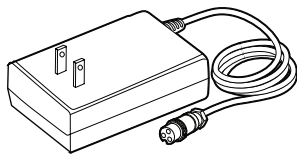

**Note:** Make sure power is turned **OFF** when unit is not in use. If the power switch is left on for an extended period of time, the battery may reach a stage at which it will no longer hold a charge.

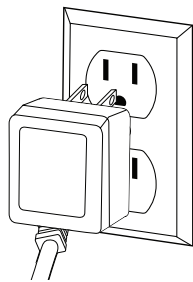

**1** Plug the charger into a wall outlet. If the lights on charger do not light up, check the power to the outlet. If necessary, try a different outlet.

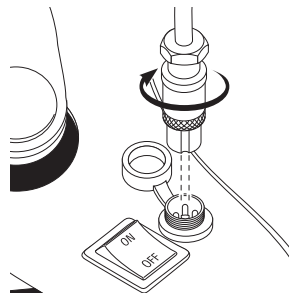

**2** Turn power **OFF** before charging. Plug the charger into the charger port to charge unit.

## REPAIR AND MAINTENANCE

**Turn power switch OFF before conducting any maintenance procedures.**

### □ Adjusting the Brake

**Tools required:** 5mm Allen wrench

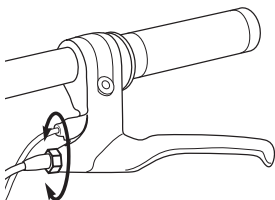

**1** To adjust the tension, thread the brake lever adjuster in or out 1/4 to 1/2 turn until the desired brake adjustment is attained. Most adjustments are complete at this step. If brake still needs further adjustment, proceed to step 2 for rear brake.

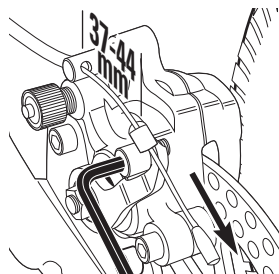

**2** Locate the rear brake caliper and disk brake behind the right rear wheel. The distance of the brake wire between the end of the cable and the anchor bolt should be between 37 and 44 mm. If the rear brake has too much slack, loosen the rear anchor bolt with a 5mm Allen wrench and pull the brake wire tighter (direction indicated with arrow).

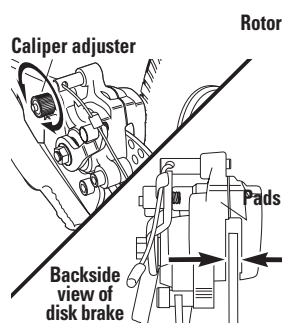

**3** If the brake rotor is dragging on the brake pads use your fingers to twist the caliper adjuster in either direction until rotor is centered between pads.

### **⚠ WARNING:**

Rechargeable batteries are only to be charged under adult supervision. Always disconnect your electric four wheeler from the charger before cleaning with liquid.

**Note:** If your charger does not look like the one illustrated, your unit has been supplied with an alternative charger. The specifications and charging procedure would not change.

The charger has a small window with one LED to indicate the charge status. Refer to the illustration on the charger unit for the actual "charging" and "charged" status indications for your model charger.

Chargers have built-in over-charge protection to prevent battery from being over-charged.

Charger will get warm during use. This is normal for some chargers and is no cause for concern. If your charger does not get warm during use, it does not mean that it is not working properly.

**⚠ WARNING:** Failure to recharge the battery at least once a month may result in a battery that will no longer hold a charge.

### **⚠ WARNING:**

The brake is capable of causing the electric four wheeler to skid the tire throwing an unsuspecting rider. Practice in an open area free from obstacles until you are familiar with the brake function. Avoid skidding to a stop as this can cause you to lose control or damage the rear tire(s).

# REPAIR AND MAINTENANCE

## □ Replacing the Fuse

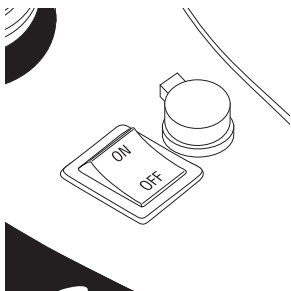

**1** Make sure the power switch is turned **OFF**.

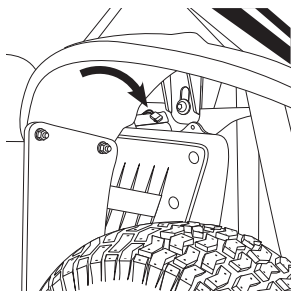

**2** Under the front fender and through the frame, locate the fuse box attached to the top of the battery.

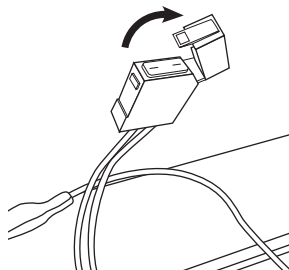

**3** Open the fuse cover to expose the fuse.

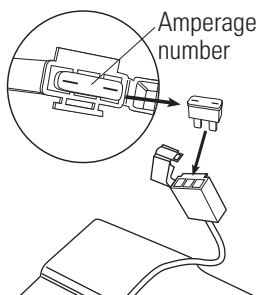

**4** Remove the fuse and replace with a new one of equal amperage.

**Note:** Amperage rating is located on top of fuse.

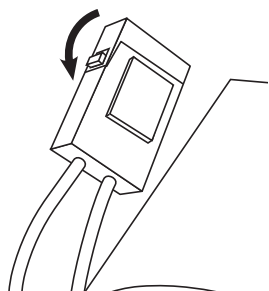

**5** Close the fuse cover.

## □ Replacing the Chain

**Tools required:** 6mm Allen wrench, 10mm open wrench and Phillips screwdriver.

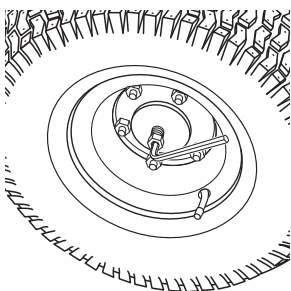

**1** Remove the bolt and washers on the outside of the rear wheel.

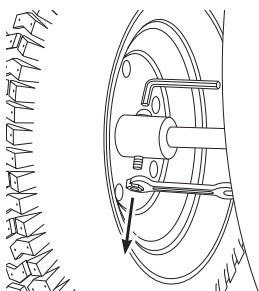

**2** Remove the bolt on the inside of the rear wheel. Remove nut and pull bolt out of axle.

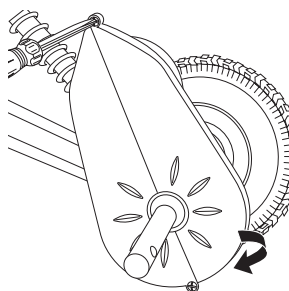

**3** Remove the 3 screws from the top half of the chain guard and remove.

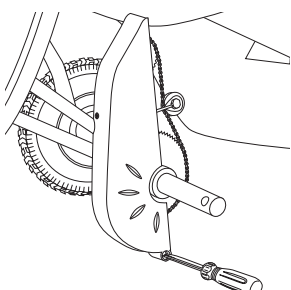

**4** Remove the 2 screws from the bottom half of the chain guard and remove.

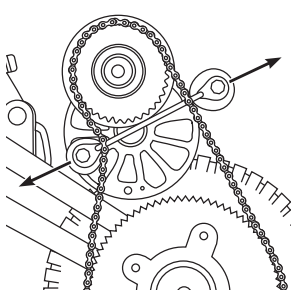

**5** Spread the chain tensioner apart to loosen chain.

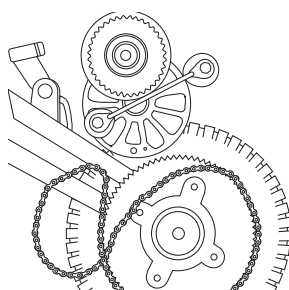

**6** Remove chain from both sprockets and replace with new chain.

### ⚠ **WARNING:**

To prevent shock, please follow the instructions accordingly and do not skip or combine any steps.

### ⚠ **WARNING:**

Do not touch motor after use. Motor is (or can be) very hot.

## REPAIR AND MAINTENANCE

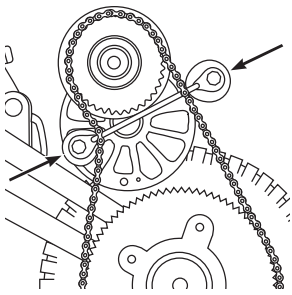

**7** Reset chain tensioner.

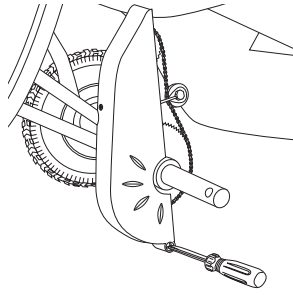

**8** Position bottom half of the chain guard to align mounting holes and screw to frame.

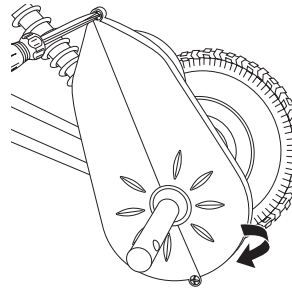

**9** Position top half of the chain guard to align mounting holes and screw to frame.

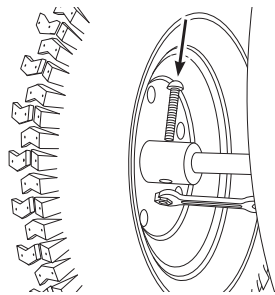

**10** On the inside of the wheel slide bolt through wheel and axle and secure with nut.

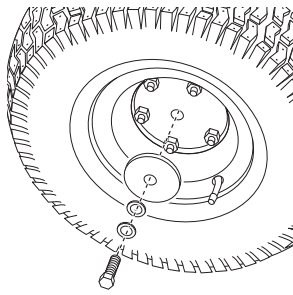

**11** On the outside of the wheel replace washers and secure with bolt.

### ❑ Chain and Sprocket

The chain will typically have a "loose spot" and "tight spot" corresponding with a particular sprocket rotational position. This is normal and common to all chain-driven products due to run-out tolerances of the freewheel and sprocket. Proper chain alignment must be maintained. If the chain is noisy or rough running, check the lubrication, tension and alignment of the sprockets, in that order. The chain tensioner must be aligned and free from binding and the tensioner spring(s) must be operating correctly.

### ❑ Battery Care and Disposal

Do not store the battery in temperatures above 75° F or below -10° F.



CONTAINS SEALED LEAD BATTERY. BATTERY MUST BE RECYCLED.

**Disposal:** Your Razor product uses sealed lead-acid batteries which must be recycled or disposed of in an environmentally sound manner. Do not dispose of a lead-acid battery in a fire. The battery may explode or leak. Do not dispose of a lead-acid battery in your regular household trash. The incineration, land filling or mixing of sealed lead-acid batteries with household trash is prohibited by law in most areas. Return exhausted batteries to a federal or state approved lead-acid battery recycler or a local seller of automotive batteries. If you live in Florida or Minnesota, it is prohibited by law to throw away lead-acid batteries in the municipal waste stream.

### ❑ Charger

The charger supplied with the electric four wheeler should be regularly examined for damage to the cord, plug, enclosure and other parts, and, in the event of such damage, the Dirt Quad must not be charged until it has been repaired or replaced.

Use ONLY with the recommended charger.

### ❑ Replacement Parts

For a complete selection of parts, visit [www.razor.com](http://www.razor.com).

### ❑ Repair Centers

For a list of authorized Razor repair centers:

- Check online at [www.razor.com](http://www.razor.com).
- Call 866-467-2967 for the center nearest you.

### ⚠ WARNING:

To avoid a pinch or injury, keep fingers away from moving sprockets and chain.

### ⚠ WARNING:

If a battery leak develops, avoid contact with the leaking acid and place the damaged battery in a plastic bag. Refer to the disposal instructions at left. If acid comes into contact with skin or eyes, flush with cool water for at least 15 minutes and contact a physician.

# TROUBLESHOOTING GUIDE

<b>Problem</b>	<b>Possible Cause</b>	<b>Solution</b>
Product does not run	Product is rolling backwards	Throttle will not engage if the product is rolling backwards. Come to a complete stop and then activate the throttle.
	Undercharged battery	Charge the battery. A new battery should have been charged for at least 12 hours before using the product for the first time and up to 12 hours after each subsequent use.  Check all connectors. Make sure the charger connector is tightly plugged into the charging port, and that the charger is plugged into the wall.
Product suddenly stopped working while in use	Loose wires or connectors	Check all wires and connectors to make sure they are tight.
	Burned-out fuse	The fuse will burn out and automatically shut off the power if the motor is overloaded.  An excessive overload, such as too heavy a rider or too steep a hill, could cause the motor to overheat. Refer to replacing the fuse instructions on page 5 of this manual. Correct the conditions that caused the fuse to burn out and avoid repeatedly burning out fuse.
	Motor or electrical switch damage	Contact your local Razor authorized service center for diagnosis and repair.
Short run time (less than 15 minutes per charge)	Undercharged battery	Charge the battery. A new battery should have been charged for at least 12 hours before using the product for the first time and up to 12 hours after each subsequent use.  Check all wires and connectors. Make sure the battery connector is tightly plugged into the charger connector, and that the charger is plugged into the wall.
	Brakes are not adjusted properly	Refer to brake adjustment instructions on page 4 of this manual.
Product runs sluggishly	Riding conditions are too stressful	Use only on solid, flat clean and dry surfaces such as pavement or level ground.
	Tires are not properly inflated	The tires are inflated when shipped, but they invariably will lose some pressure between the point of manufacturing and your purchase. Refer to instructions on page 4 of this manual to properly inflate tires.
	Product is overloaded	Make sure you do not overload the product by allowing more than one rider at one time, exceeding the maximum weight limit, going up too steep a hill or towing objects behind the product.
Sometimes the product doesn't run, but other times it does	Loose wires or connectors	Check all wires around the motors and all connectors to make sure they are tight.
	Motor or electrical switch damage	Contact your local Razor authorized service center for diagnosis and repair.
Product makes loud noises or grinding sounds	Chain is too dry	Apply a lubricant such as 3 in 1™ or Tri-Flow™ to the chain.



# DIRT QUAD PARTS

Keep your Dirt Quad running for years with genuine Razor parts. Visit our website or e-mail us for more information on spare part availability. (Specifications subject to change without notice.)

- |     |                              |    |                            |
|-----|------------------------------|----|----------------------------|
| 1   | Handlebar grips (right/left) | 12 | Motor (350W)               |
| 2   | Speed controller             | 13 | Chain tensioner            |
| 2-1 | Sleeve                       | 14 | Battery cover (right/left) |
| 3   | Handlebar                    | 15 | Rear wheel complete        |
| 4   | Brake lever assembly         | 16 | Caliper brake              |
| 5   | Handlebar clamps             | 17 | Disc brake                 |
| 6   | Shock                        | 18 | Chain                      |
| 7   | Front wheel complete         | 19 | Sprocket                   |
| 8   | Adjustable tie rod           | 20 | Chain guard (upper/lower)  |
| 9   | Control module               | 21 | Plastic body with seat     |
| 10  | Battery (2-12V/7Ah)          | 22 | On/Off switch              |
| 11  | Fuse                         | 23 | Charger port               |

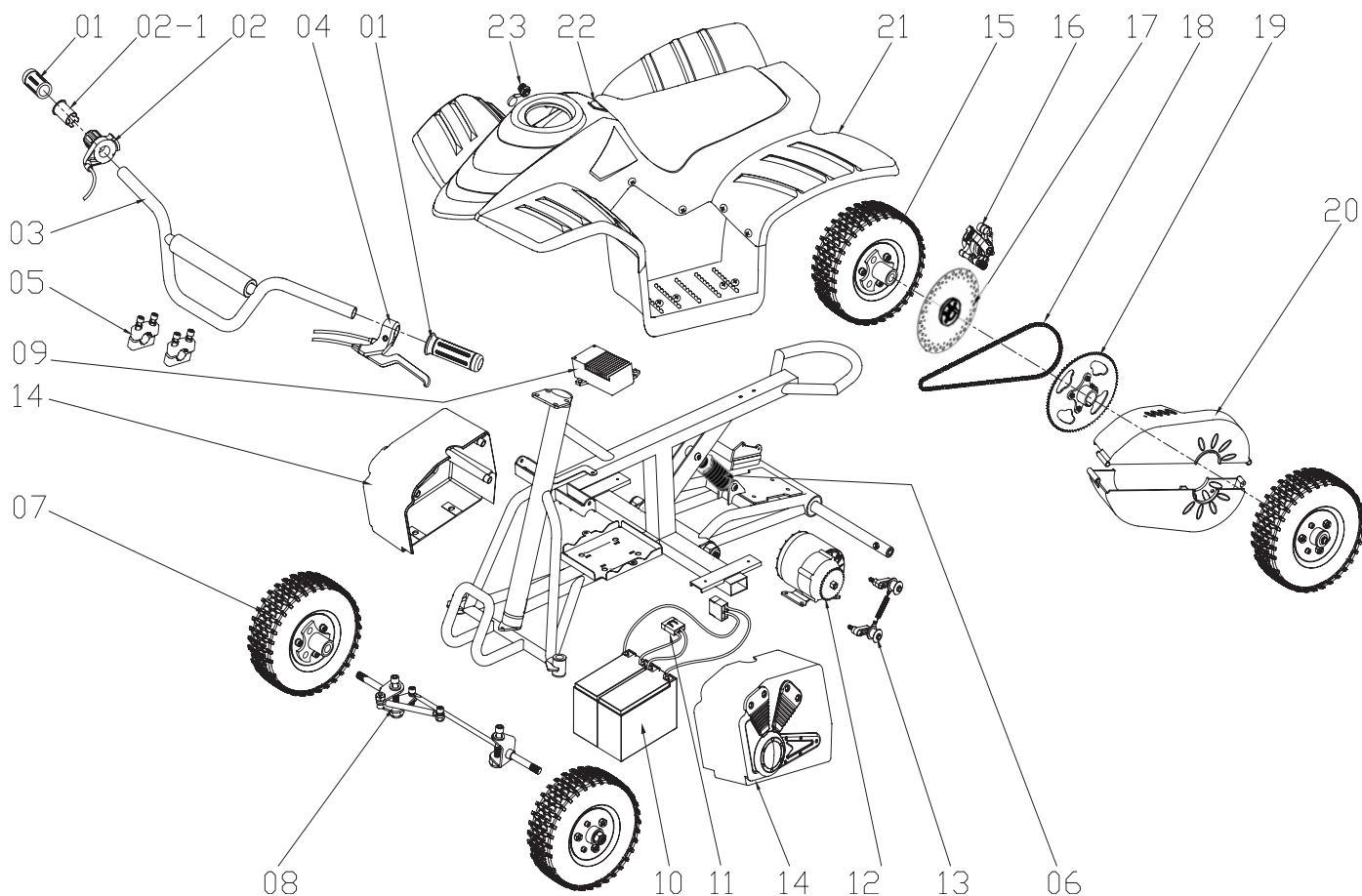

**Need Help?** Visit our website for replacement parts, product support and a list of authorized service centers at [www.razor.com](http://www.razor.com) or call toll-free at 866-467-2967 Monday - Friday 8:00 AM - 5:00 PM Pacific Time.

**SB 1918 (CALIFORNIA) DECLARATION**

YOUR INSURANCE POLICIES MAY NOT PROVIDE COVERAGE FOR ACCIDENTS INVOLVING THE USE OF THIS SCOOTER/ELECTRIC RIDE-ON PRODUCT. TO DETERMINE IF COVERAGE IS PROVIDED, YOU SHOULD CONTACT YOUR INSURANCE COMPANY OR AGENT.

## SAFETY REMINDERS

### PRE-RIDE CHECKLIST



#### Loose Parts

Check and secure all fasteners before every ride. Make sure steering clamp bolts are locked properly in place. There should not be any unusual rattles or sounds from loose parts or broken components. If you are not sure, ask an experienced mechanic to check.



#### Brake

Check the brake for proper function. When you squeeze the lever, the brake should provide positive braking action. When you apply the brake with the speed control on, the brake cut-off switch will stop the motor.



#### Frame, Fork and Handlebars

Check for cracks or broken connections. Although broken frames are rare, it is possible for an aggressive rider to run into a curb or wall and wreck and bend or break a frame. Get in the habit of inspecting yours regularly.



#### Tire Inflation

Periodically inspect the tires for excess wear, and regularly check the tire pressure and re-inflate as necessary. If you get a flat tire, the inner tube can be patched or a new tube can be purchased from Razor or an authorized repair center.



#### Safety Gear

Always wear proper protective equipment such as an approved safety helmet, elbow pads and kneepads. Always wear shoes (lace-up shoes with rubber soles), never ride barefooted or in sandals, and keep shoelaces tied and out of the way of the wheels, motor and drive system.

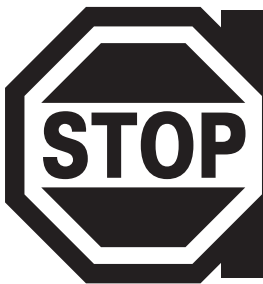

## DO NOT RETURN TO STORE

**Do not use this product for the first time until you have inflated the tires to the correct PSI and charged the battery for at least 12 hours.**

**Failure to follow these instructions may damage your product and void your warranty.**

## WARRANTY

### Razor Limited Warranty

The manufacturer warrants this product to be free of manufacturing defects for a period of 90 days from date of purchase. This Limited Warranty does not cover normal wear and tear, tires, tubes or cables, or any damage, failure or loss caused by improper assembly, maintenance, or storage or use of the Razor Dirt Quad.

This Limited Warranty will be void if the product is ever:

- used in a manner other than for recreation;
- modified in any way;
- rented.

The manufacturer is not liable for incidental or consequential loss or damage due directly or indirectly to the use of this product.

Razor does not offer an extended warranty. If you have purchased an extended warranty, it must be honored by the store at which it was purchased.

For your records, save your original sales receipt with this manual and write the serial number below.

Item Number:  
**25143060**

**Need Help?** Visit our website for replacement parts, product support and a list of authorized service centers at [www.razor.com](http://www.razor.com) or call toll-free at 866-467-2967 Monday - Friday 8:00 AM - 5:00 PM Pacific Time.

## Free Manuals Download Website

<http://myh66.com>

<http://usermanuals.us>

<http://www.somanuals.com>

<http://www.4manuals.cc>

<http://www.manual-lib.com>

<http://www.404manual.com>

<http://www.luxmanual.com>

<http://aubethermostatmanual.com>

Golf course search by state

<http://golfingnear.com>

Email search by domain

<http://emailbydomain.com>

Auto manuals search

<http://auto.somanuals.com>

TV manuals search

<http://tv.somanuals.com>