



E100

E150

E200

E300



OWNER'S MANUAL

**Read and understand this entire manual before riding!
DO NOT RETURN TO STORE!**

⚠ NOTE: E100/125/150 must be traveling 3mph before motor will engage. Kick start to 3mph then twist the throttle to start motor.

Item Numbers

E100	13100E-BL
E125	13125E-BK Black
	13111110 Red
E150	13111612
E200	13200E-SL
E200S	13201S-SL
E225S	13112850
E300	13300E-SL
E300S	13301S-SL
E325S	13116390

CONTENTS

Safety Warnings	1	Troubleshooting Guide.....	11-12
Before You Begin.....	2	E100, E150, E200 and E300 Scooter Parts	13-20
Assembly and Set-Up	3-4	Safety Reminders.....	Back Cover
Repair and Maintenance.....	4-10	Warranty	Back Cover

SAFETY WARNINGS

⚠ WARNING: Riding the E100, E200 or E300 scooter can be a hazardous activity. Certain conditions may cause the equipment to fail without fault of the manufacturer. Like other electric vehicles, the scooter can and is intended to move, and it is therefore possible to lose control, fall off and/or get into dangerous situations that no amount of care, instruction or expertise can eliminate. If such things occur you can be seriously injured or die, even when using safety equipment and other precautions. **RIDE AT YOUR OWN RISK AND USE COMMON SENSE.**

This manual contains many warnings and cautions concerning the consequences of failing to maintain, inspect or properly use your E100, E200 or E300 scooter. Because any incident can result in serious injury or even death, we do not repeat the warning of possible serious injury or death each time such a possibility is mentioned.

APPROPRIATE RIDER USE AND PARENTAL SUPERVISION

This manual contains important safety information. It is your responsibility to review this information and make sure that all riders understand all warnings, cautions, instructions and safety topics and assure that young riders are able to safely and responsibly use this product. Razor recommends that you periodically review and reinforce the information in this manual with younger riders, and that you inspect and maintain your children's vehicle to insure their safety.

The recommended rider ages of 8 and older for the E100 scooter and 12 and older for the E200 and E300 scooters are only estimates, and can be affected by the rider's size, weight or skills. Any rider unable to fit comfortably on the scooter should not attempt to ride it.

A parent's decision to allow his or her child to ride this product should be based on the child's maturity, skill and ability to follow rules.

Keep this product away from small children and remember that it is intended for use only by persons who are, at a minimum, completely comfortable and competent while operating the vehicle.

DO NOT EXCEED THE WEIGHT LIMIT OF 120 pounds for the E100 and E150 scooter or 220 pounds for the E200 and E300 scooters.

Rider weight does not necessarily mean a person's size is appropriate to fit or maintain control of the scooter.

Do not touch the brakes or motor on your scooter when in use as these parts can become very hot.

Refer to the section on safety for additional warnings.

ACCEPTABLE RIDING PRACTICES AND CONDITIONS

Always check and obey any local laws or regulations which may affect the locations where the E100, E200 or E300 scooter may be used.

Ride defensively. Watch out for potential obstacles that could catch your wheel or force you to swerve suddenly or lose control. Be careful to avoid pedestrians, skaters, skateboards, scooters, bikes, children or animals who may enter your path, and respect the rights and property of others.

Do not activate the speed control on the hand grip unless you are on the scooter and in a safe, outdoor environment suitable for riding. The E100 scooter must be moving at 3 miles per hour before the motor will start.

Failing to properly adjust and tighten the clamps and retainers that affix the handlebars and folding system can cause you to lose control and fall. When properly adjusted, you cannot twist the front wheel out of line with the handlebars or move the T-tube out of adjustment. If you can twist or force these components to move or come off by hand, readjust and properly retighten clamp mechanisms.

Do not attempt or do stunts or tricks on your E100, E200 or E300 scooter. The scooters are not made to withstand abuse from misuse such as jumping, curb grinding or any other type of stunts.

Maintain a hold on the handlebars at all times.

Never carry passengers or allow more than one person at a time to ride the scooter.

Never use near steps or swimming pools.

Keep your fingers and other body parts away from the chain, drive chain, steering system, wheels and all other moving components.

Never use headphones or a cell phone when riding.

Never hitch a ride with another vehicle.

Do not ride your scooter in wet or icy weather and never immerse the scooter in water, as the electrical and drive components could be damaged by water or create other possibly unsafe conditions.

The E100, E200 and E300 scooters are intended for use on flat, dry surfaces such as pavement or level ground without loose debris such as sand, leaves, rocks or gravel. Wet, slick, bumpy, uneven or rough surfaces may impair traction and contribute to possible accidents. Do not drive your scooter in mud, ice, puddles or water. Avoid excessive speeds that can be associated with downhill rides. Never risk damaging surfaces such as carpet or flooring by use of an E100, E200 or E300 scooter indoors.

Do not ride at night or when visibility is limited.

PROPER RIDING ATTIRE

Always wear proper protective equipment such as an approved safety helmet (with chin strap securely buckled), elbow pads and kneepads. A helmet may be legally required by local law or regulation in your area. A long-sleeved shirt, long pants, and gloves are recommended. Always wear athletic shoes (lace-up shoes with rubber soles), never drive barefooted or in sandals, and keep shoelaces tied and out of the way of the wheels, motor and drive system.

USING THE CHARGER

The charger supplied with the E100, E200 or E300 scooter should be regularly examined for damage to the cord, plug, enclosure and other parts, and in the event of such damage, the bike must not be charged until the charger has been repaired or replaced.

Use only with the recommended charger.

The charger is not a toy.

Always disconnect from the charger prior to wiping down and cleaning your scooter with liquid.

FAILURE TO USE COMMON SENSE AND HEED THE ABOVE WARNINGS INCREASES RISK OF SERIOUS INJURY. USE WITH APPROPRIATE CAUTION AND SERIOUS ATTENTION TO SAFE OPERATION.

BEFORE YOU BEGIN

Remove contents from box. Remove the foam separators that protect the components from damage during shipping. Inspect the contents of the box for scratches in the paint, dents or kinked cables that may have occurred during shipping. Because the scooter was 95 percent assembled and packed at the factory, there should not be any problems, even if the box has a few scars or dents.

Estimated Assembly and Set-Up Time

Razor recommends assembly by an adult with experience in bicycle mechanics. Allow up to 20 minutes for assembly, not including initial charge time. Allow up to 12 hours for initial charge (see page 3 for charging information).

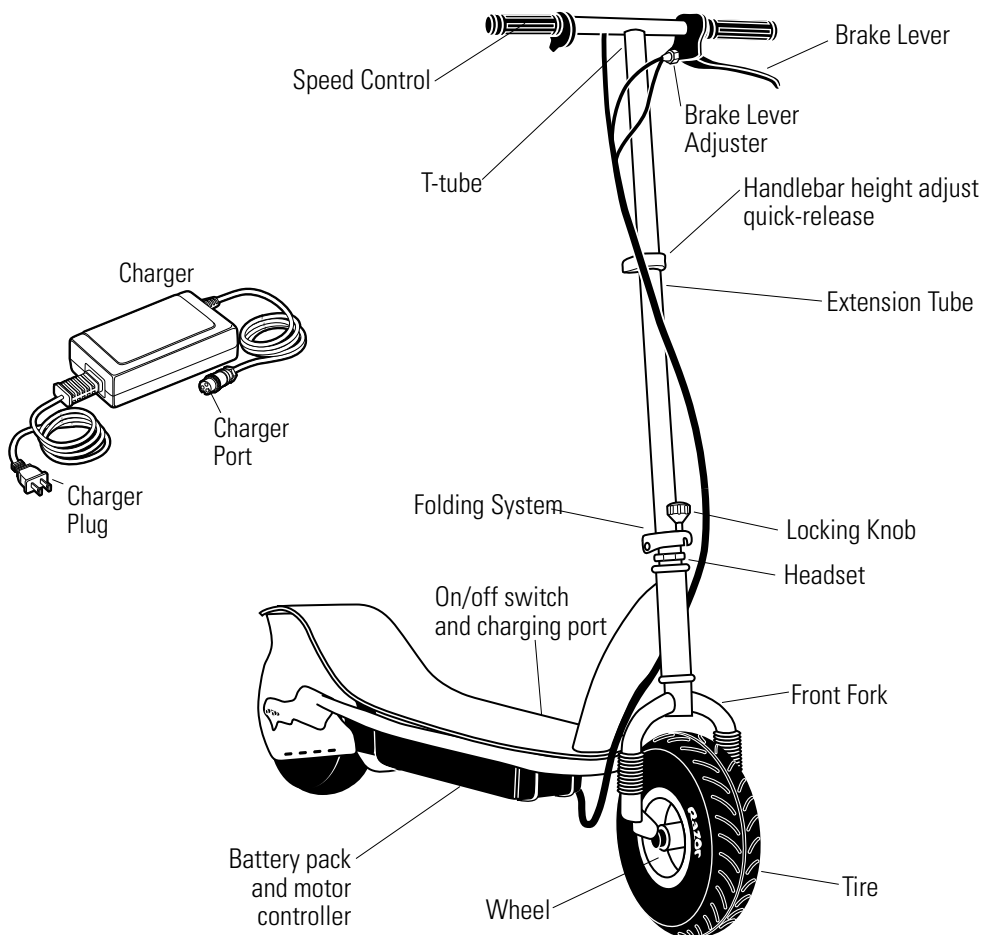

WARNING:
DO NOT USE NON-RAZOR PRODUCTS WITH YOUR RAZOR ELECTRIC SCOOTER. The scooter has been built to certain Razor design specifications. The original equipment supplied at the time of sale was selected on the basis of its compatibility with the frame, fork and all other parts. Certain aftermarket products may or may not be compatible.

Required Tools

Some tools may be supplied; however, we recommend the use of mechanic's grade tools. Use the supplied tools only as a last resort.

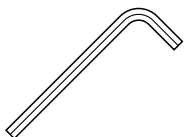

6mm hexagonal key wrench (included)

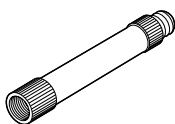

Inflation valve adapter/extender (with E200 & E300 only)

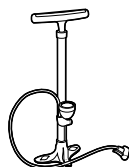

Bicycle-style tire pump for Schrader valve tires, with pressure gauge

Need Help? Visit our web site for updates and a list of authorized service centers at www.razor.com or call toll-free at **866-467-2967** Monday - Friday 8:00 AM - 5:00 PM Pacific Time.

ASSEMBLY AND SET-UP

□ Charging the Battery

Your electric scooter may not have a fully charged battery. Therefore it is a good idea to charge the battery prior to use.

- Initial charge time: 12 hours
- Recharge time: up to 8 hours, Battery should be recharged a minimum of 8 hours after each use. When the vehicle is not in regular use, recharge the battery at least once a month until normal use is resumed.

- Run time: up to 40 minutes
- Average battery life: 250 charge/discharge cycles

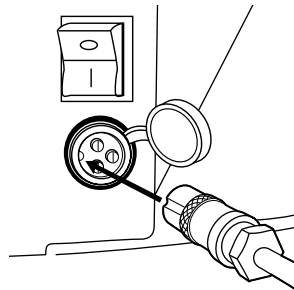
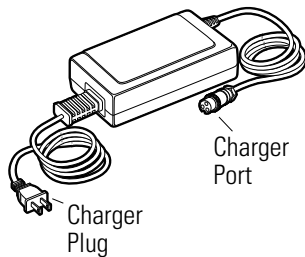

1 Plug the charger port into the port on the scooter. The charger works with the power switch in either the on or off position. The charging input, on/off switch and overload breaker are located under the deck at the front left-hand side.

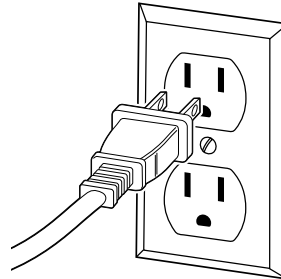

2 Plug the charger plug into a wall outlet.

□ Attaching the Handlebars

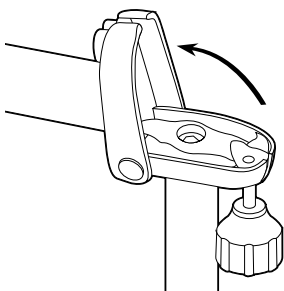

1 Loosen the locking knob and swing to the 6 o'clock position to unfold the handlebar.

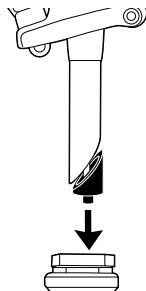

2 Remove the plastic protector covering the base of the handlebar assembly. Insert the "quill" part of the handlebar assembly into the fork. You may have to loosen the wedge to allow it to slip into the fork.

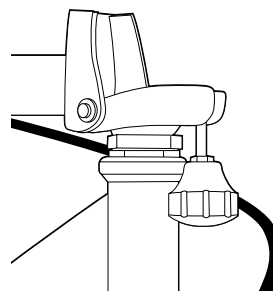

3 Slide the quill into the fork until it bottoms on the headset.

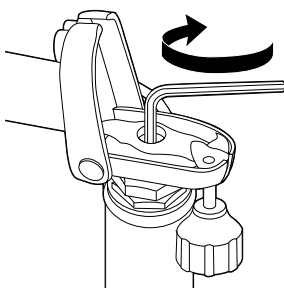

4 Using a 6mm hexagonal key wrench, tighten the wedge by turning the bolt clockwise. The wedge is properly tightened when the handlebars cannot be twisted out of alignment with the front wheel.

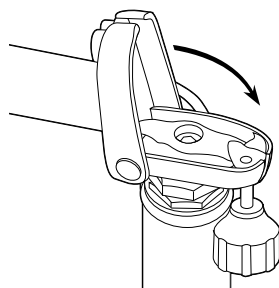

5 Pivot the handlebar assembly upright.

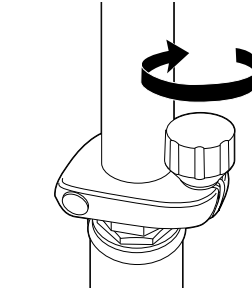

6 Swing the locking knob to the 12 o'clock position and tighten by hand as firmly as possible.

⚠ WARNING: Always disconnect your scooter from the charger before cleaning with liquid.

Note: If your charger does not look like the one illustrated, your unit has been supplied with an alternative charger. The specifications and charging procedure would not change.

The charger has a small window with one LED or two LEDs to indicate the charge status. Refer to the illustration on the charger unit for the actual "charging" and "charged" status indications for your model charger.

Chargers have built-in over-charge protection to prevent battery from being over-charged.

Be sure to properly align the groove on the charger input plug with the corresponding socket on the case; otherwise, no charging action will occur.

⚠ WARNING: Failure to recharge the battery at least once a month may result in a battery that will no longer accept a charge.

⚠ WARNING: Failure to properly tighten the wedge may allow the handlebars to dislodge while riding and may cause you to lose control and fall. When correctly tightened, the handlebars will not rotate out of alignment with the front wheel under normal circumstances.

⚠ WARNING: Keep your fingers clear of the pivoting mechanism when folding or unfolding the scooter, and make sure others are standing clear.

Note: The cable and wire assembly from the handlebar must not wrap around the steering tube or handlebar as shown in step 3. Sharp bends or twisting of the brake cable can cause the brakes to malfunction.

ASSEMBLY AND SET-UP

□ Adjusting the Handlebar Height (E100/E200/E300 only)

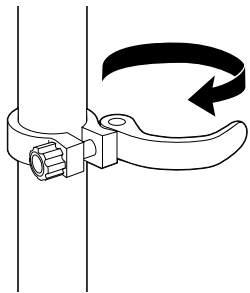

1 Pull the quick-release lever outward.

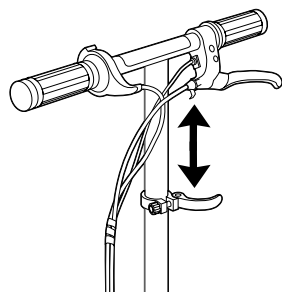

2 Slide the T-tube to the desired position and secure by pushing the quick-release lever.

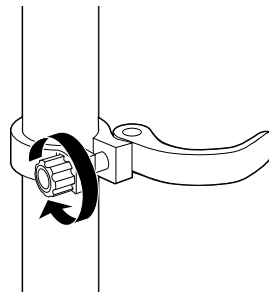

3 The tension of the quick-release clamping mechanism can be adjusted by tightening or loosening the bolt with your fingers.

⚠ WARNING: Failure to properly engage the quick-release clamp may cause the T-tube to move up or down while riding, which may cause you to lose control and fall. With the quick-release properly adjusted and engaged, the handlebars will not move up or down.

Note: Be careful not to over-tighten. You should be able to open and close the quick-release lever by hand, and the T-tube should move up and down freely with the quick-release open.

□ Riding Your Scooter

Testing the Brakes – To use the brakes, squeeze the front and back brake levers to increase the pressure on the brake. The brake lever is fitted with a cable adjuster to compensate for cable stretch and/or to fine-tune the lever movement to brake engagement. If brake is not engaging properly, follow instructions for adjusting the brakes on page 5.

Note: The E100 must be going 3 mph before the motor will start. Kick to 3 mph then activate the speed control while simultaneously pressing the green “go” button to engage the motor.

REPAIR AND MAINTENANCE

Check the Razor web site for any updates on the latest repair and maintenance procedures.
Turn power switch off before conducting any maintenance procedures.

□ Adjusting the Brakes

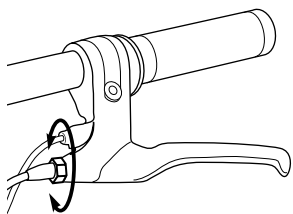

1 To adjust the brake cable play, thread the brake lever adjuster in or out 1/4 to 1/2 turn until the desired brake adjustment is attained. Most adjustments are complete at this step. If brake still needs further adjustment, proceed to step 2.

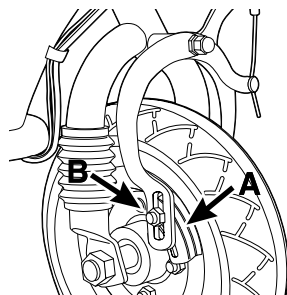

2 (E100) Inspect the brake pads (A) for proper alignment against the wheel or excess wear. To realign brake pads, loosen the fixing nut (B) and adjust the pad to contact the rim. Retighten and test the function, readjust as needed.

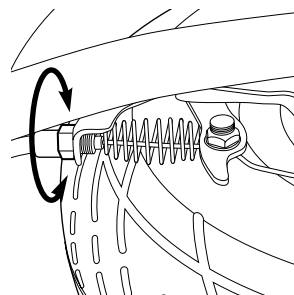

2 (E125, E200 & E300) If the brake lever adjuster is threaded outward and the brake still has too much slack, use the rear brake adjuster for additional adjustment.

⚠ WARNING: The brake is capable of skidding the tire and throwing an unsuspecting rider. Practice in an open area free from obstacles until you are familiar with the brake function. Avoid skidding to a stop as this can cause you to lose control or damage the rear tire.

REPAIR AND MAINTENANCE

□ Inflating the Tires

Tires are inflated when shipped, but they invariably lose some pressure between the point of manufacturing and your purchase.

E150 / E200 / E300 Rear Tire

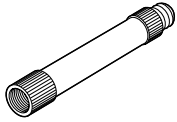

1 Use the special valve extender/adaptor supplied. The valve adapter is located in the bag with the owners manual supplied at the time of purchase.

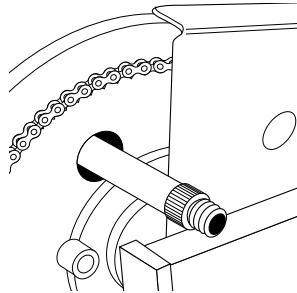

2 Align the access hole in the drive sprocket with the tire valve. Thread the adapter completely onto the valve and attach the pump. Inflate to the PSI indicated on the tire sidewall.

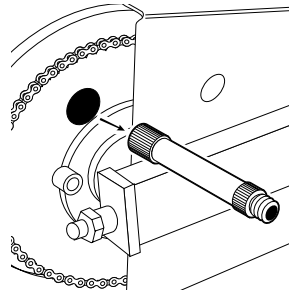

3 Remove valve adapter immediately after inflating.

E150 / E200 / E300 Front Tire and E100 Tires

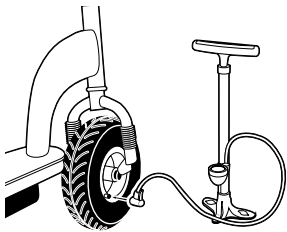

1 Using a bicycle style tire pump equipped for a Schrader-type valve, inflate the front tire to the PSI indicated on the sidewall of the tire.

⚠ WARNING: Failure to remove the valve adapter after inflating will cause the inner tube and/or adapter to be severed by the rear drive sprocket.

Note: If you lose the adapter, a valve stem extender can be purchased at almost any auto parts store.

Note: The pressurized air supplies found at gasoline stations are designed to inflate high-volume automobile tires. If you decide to use such an air supply to inflate your electric scooter tires, first make sure the pressure gauge is working, then use very short bursts to inflate to the correct PSI. If you inadvertently over-inflate the tire, release the excess pressure immediately.

REPAIR AND MAINTENANCE

□ Adjusting the Chain

Tools required: 10mm wrench, two (2) 8mm wrenches, and two (2) 17mm wrenches.

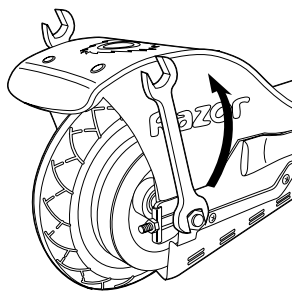

1 Using two 17mm wrenches, loosen the rear axle bolts by turning the wrenches counter clockwise.

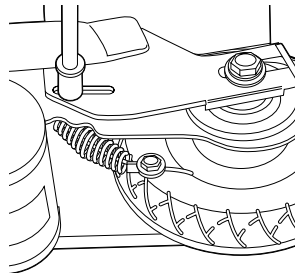

2 Using two 8mm wrenches, loosen the brake housing anchor which is located in the long slot on the left side of the rear fork.

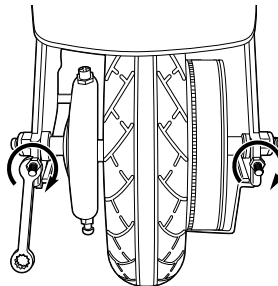

3 Using a 10mm wrench, tighten the tension adjusters on the axle 1/8 to 1/4 turn to fine-tune the chain tension. Both adjusters must be tightened the exact same amount to maintain wheel alignment.

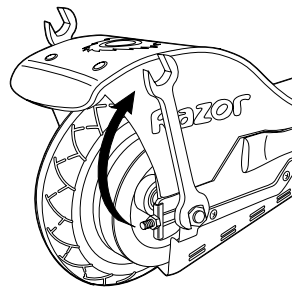

4 Once the tension is correct, tighten the axle and brake anchor bolt. Test run the scooter. Readjust as needed.

Note: This system of adjusters is common to motorcycles and BMX bicycles. If you are not familiar with it or do not feel comfortable performing the adjustment, consult an authorized Razor service center or a qualified BMX bike or motorcycle mechanic.

The chain should be “just taut” – in other words snug, but not piano-wire tight. The tension should be similar to the fan chain on an automobile. BE CAREFUL NOT TO ADJUST TOO TIGHT. The tensioning system can easily impart too much tension and snap the chain or bend the motor shaft. Adjust 1/8 to 1/4 turn at a time and check the tension each time.

REPAIR AND MAINTENANCE

Chain and Rear Tire Replacement

Tools required: Phillips screwdriver, 10mm wrench, two (2) 8mm wrenches, and two (2) 17mm wrenches.

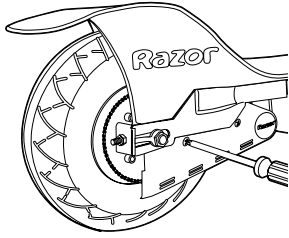

1 With a Phillips screwdriver, loosen the two screws and remove the chain guard.

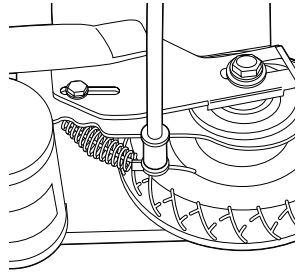

2 With a 10mm wrench, loosen the brake cable anchor and disconnect the cable.

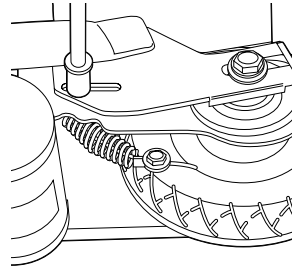

3 With two 8mm wrenches, loosen brake housing anchor and disconnect. Keep the spacer and washers together.

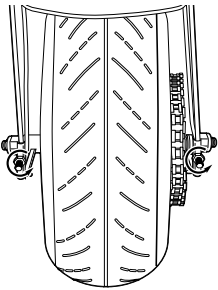

4 With a 10mm wrench, loosen both axle adjusters an equal amount, about five turns.

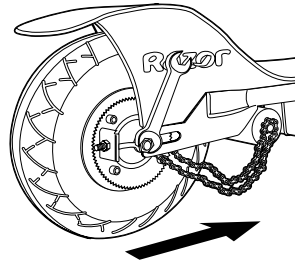

5 With two 17mm wrenches, loosen the axle. Push the wheel forward in the slots to loosen the chain.

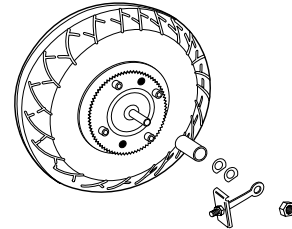

6 Pull the wheel out. Note the arrangement of the hardware sequence. The spacer order is small, medium and large, with the small spacer between the brake and frame, the medium between the brake and wheel and the long between the wheel and frame.

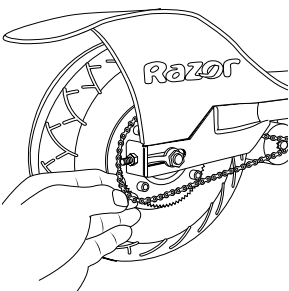

7 Install new chain or wheel by maneuvering the chain onto the sprocket and slipping the axle into the slots on the frame.

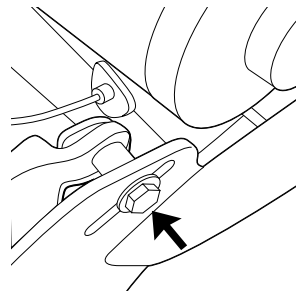

8 To hook up the brake housing anchor, align the cable guide adjuster and install the spacer and bolt. Do not tighten until final step.

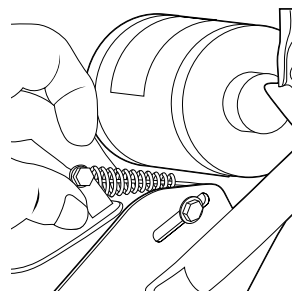

9 Install the brake spring and thread the cable wire into the cable anchor. Thread the cable to its original position and tighten securely.

REPAIR AND MAINTENANCE

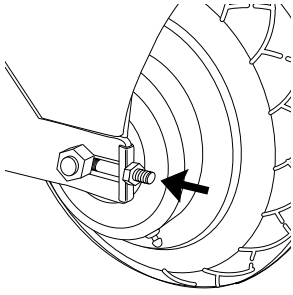

10 Install the axle adjusters and axle nuts. Tighten until they just barely hold the hardware in place.

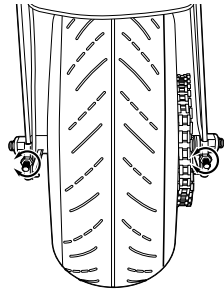

11 Tighten both axle adjusters the same number of turns to fine-tune the tension on the chain and to approximately maintain the centering of the wheel.

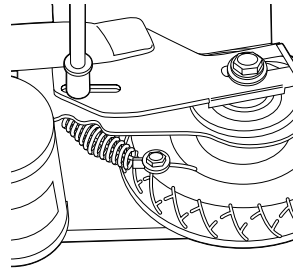

12 Tighten the brake housing anchor securely. Test ride and check. Readjust as needed.

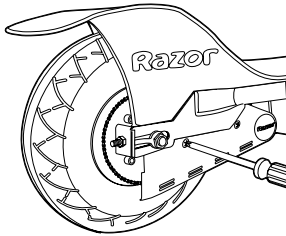

13 Replace the chain guard.

REPAIR AND MAINTENANCE

□ Front Tire Replacement

Tools required: 10mm wrench, two (2) 17mm wrenches and a flathead screwdriver.

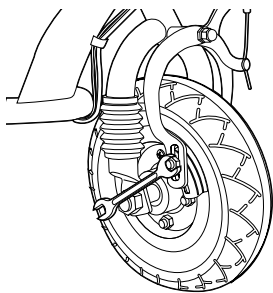

1 (E100 only, other models go to Step 2)
Loosen the brake pad bolt and remove one brake pad.

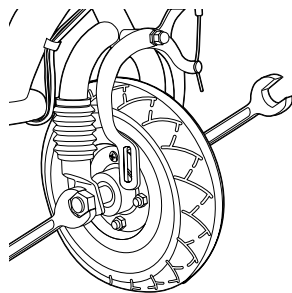

2 Using two 17mm wrenches, loosen the front axle bolts by turning the wrenches counter clockwise.

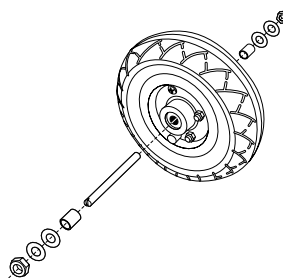

3 Remove wheel and replace tire. To reinstall wheel, reverse these steps. **Helpful hint:** You may need to use a flathead screwdriver to center the axil and the bolts.

REPAIR AND MAINTENANCE

Battery Care and Disposal

Do not store the battery in temperatures above 75° or below -10° F.



CONTAINS SEALED LEAD BATTERY. BATTERY MUST BE RECYCLED.

Disposal: Your Razor product uses sealed lead-acid batteries which must be recycled or disposed of in an environmentally sound manner. Do not dispose of a lead-acid battery in a fire. The battery may explode or leak. Do not dispose of a lead-acid battery in your regular household trash. The incineration, land filling or mixing of sealed lead-acid batteries with household trash is prohibited by law in most areas. Return exhausted batteries to a federal or state approved lead-acid battery recycler or a local seller of automotive batteries. If you live in Florida or Minnesota, it is prohibited by law to throw away lead-acid batteries in the municipal waste stream.

Charger

The transformer/charger supplied with the scooter should be regularly examined for damage to the cord, plug, enclosure and other parts, and, in the event of such damage, the scooter must not be charged until it has been repaired or replaced.

Use ONLY with the recommended charger.

Replacement Parts

The most frequently requested replacement parts (wheels, tires, tubes, batteries and chargers) are available for purchase at some Razor retail partners or online at www.razorama.com. For other parts contact an authorized Razor repair center.

Repair Centers

For a list of authorized Razor repair centers:

- Check online at www.razor.com.
- Send e-mail to customerservice@razorusa.com or call 866-467-2967 for the center nearest you.

⚠ WARNING: If a battery leak develops, avoid contact with the leaking acid and place the damaged battery in a plastic bag. Refer to the disposal instructions at left. If acid comes into contact with skin or eyes, flush with cool water for at least 15 minutes and contact a physician.

TROUBLESHOOTING GUIDE

Problem	Possible Cause	Solution
Scooter does not run	Undercharged battery	Charge the battery. A new battery should have been charged for at least 12 hours before using the scooter for the first time and up to 8 hours after each subsequent use. Check all connectors. Make sure the charger connector is tightly plugged into the charging port, and that the charger is plugged into the wall.
	Charger is not working	Make sure power flow to the wall outlet is on.
	Loose wires or connectors	You may check to see if your charger is working by using a volt meter or asking your local Razor authorized service center to test your charger for you.
	<u>E100 only</u> - Scooter must be traveling 3mph before motor will engage.	Kick start to 3mph then twist the throttle to start motor.
Scooter was running but suddenly stopped	Tripped circuit breaker	Check all wires and connectors to make sure they are tight. The circuit breaker (next to on/off switch) will automatically shut off the power if the motor is overloaded. An excessive overload, such as too heavy a rider or too steep a hill, could cause the motor to overheat. If the scooter suddenly stops running, wait a few seconds and then push the breaker to reset the circuit. Correct the conditions that caused the breaker to trip and avoid repeatedly tripping the breaker.
Short run time (less than 30 minutes per charge)	Undercharged battery	Charge the battery. A new battery should have been charged for at least 12 hours before using the scooter for the first time and up to 8 hours after each subsequent use. Check all wires and connectors. Make sure the battery connector is tightly plugged into the charger connector, and that the charger is plugged into the wall.
	Battery is old and will not accept full charge	Make sure power flow to the wall outlet is on. Even with proper care, a rechargeable battery does not last forever. Average battery life is 1 to 2 years depending on scooter use and conditions. Replace only with a Razor replacement battery.
	Brakes are not adjusted properly	Refer to adjusting the brakes instructions on page 4.
Scooter runs sluggishly	Driving conditions are too stressful	Use only on solid, flat, clean and dry surfaces such as pavement or level ground.
	Tires are not properly inflated	The tires are inflated when shipped, but they invariably will lose some pressure between the point of manufacturing and your purchase. Refer to instructions on page 5 of this manual to properly inflate tires.
	Scooter is overloaded	Make sure you do not overload the scooter by allowing more than one rider at a time, exceeding the E100 120 lb. or E200 and E300 220 lb. maximum weight limit, going up a hill or towing objects behind the scooter. If the scooter is overloaded, the circuit breaker may trip and shut off power to the motor. Correct the driving conditions that caused the overload, wait a few seconds, and then push the breaker to reset the circuit. Avoid repeatedly tripping the circuit breaker.
	Brake dragging	<u>E100</u> : Use your fingers to twist the adjuster in either direction until wheel is centered between pads. <u>E200/E300</u> : Adjust brake at lever (page 4) to allow wheel to spin without brake contact.

TROUBLESHOOTING GUIDE

Problem	Possible Cause	Solution
Sometimes the scooter doesn't run, but other times it does	Brakes are not adjusted properly Loose wires or connectors	Refer to adjusting the brakes instructions on page 4. Check all wires around the motors and all connectors to make sure they are tight.
Charger gets warm during use	Motor or electrical switch damage	Contact your local Razor authorized service center for diagnosis and repair.
Scooter does not stop when applying the brake	Normal response to charger use	No action required. This is normal for some chargers and is no cause for concern. If your charger does not get warm during use, it does not mean that it is not working properly.
Scooter makes loud noises or grinding sounds	Brakes are not adjusted properly Chain is too dry Brake rotor is dragging on brake pads	Refer to adjusting the brakes instructions on page 4. Apply a lubricant such as 3 in 1™ or Tri-Flow™ to the chain. Use your fingers to twist the caliper adjuster in either direction until rotor is centered between pads.

Need Help? Visit our web site for updates and a list of authorized service centers at www.razor.com or call toll-free at **866-467-2967** Monday - Friday 8:00 AM - 5:00 PM Pacific Time.

E100 PARTS

Keep your scooter running for years with genuine Razor parts. Visit our web site or e-mail us for more information on spare part availability. (Specifications subject to change without notice.)

- | | | | |
|------|----------------------------------|----|-----------------------------|
| 01 | Handlebar grip (right/left) | 10 | Front caliper brake |
| 02 | Single speed twist grip throttle | 11 | Battery tray |
| 02-1 | Sleeve | 12 | On/ Off switch |
| 03 | Handlebar stem/ T-bar | 13 | Charger port w/ wires |
| 03-1 | Black folding knob | 14 | Reset button w/ wire |
| 03-2 | 6mm stem bolt | 15 | Control module |
| 03-3 | Washer | 16 | Battery (2- 12V/ 4.5Ah) |
| 03-4 | Wedge | 17 | Kickstand |
| 04 | Brake lever assemble complete | 18 | Motor (24V / 100W) |
| 05 | Headset (upper) | 19 | Rear wheel complete |
| 06 | Frame | 20 | Chain |
| 07 | Headset (lower) | 20 | Chain guard |
| 08 | Front fork | 20 | Deck plate w/ grip take set |
| 09 | Front wheel complete | | |

E100 PARTS

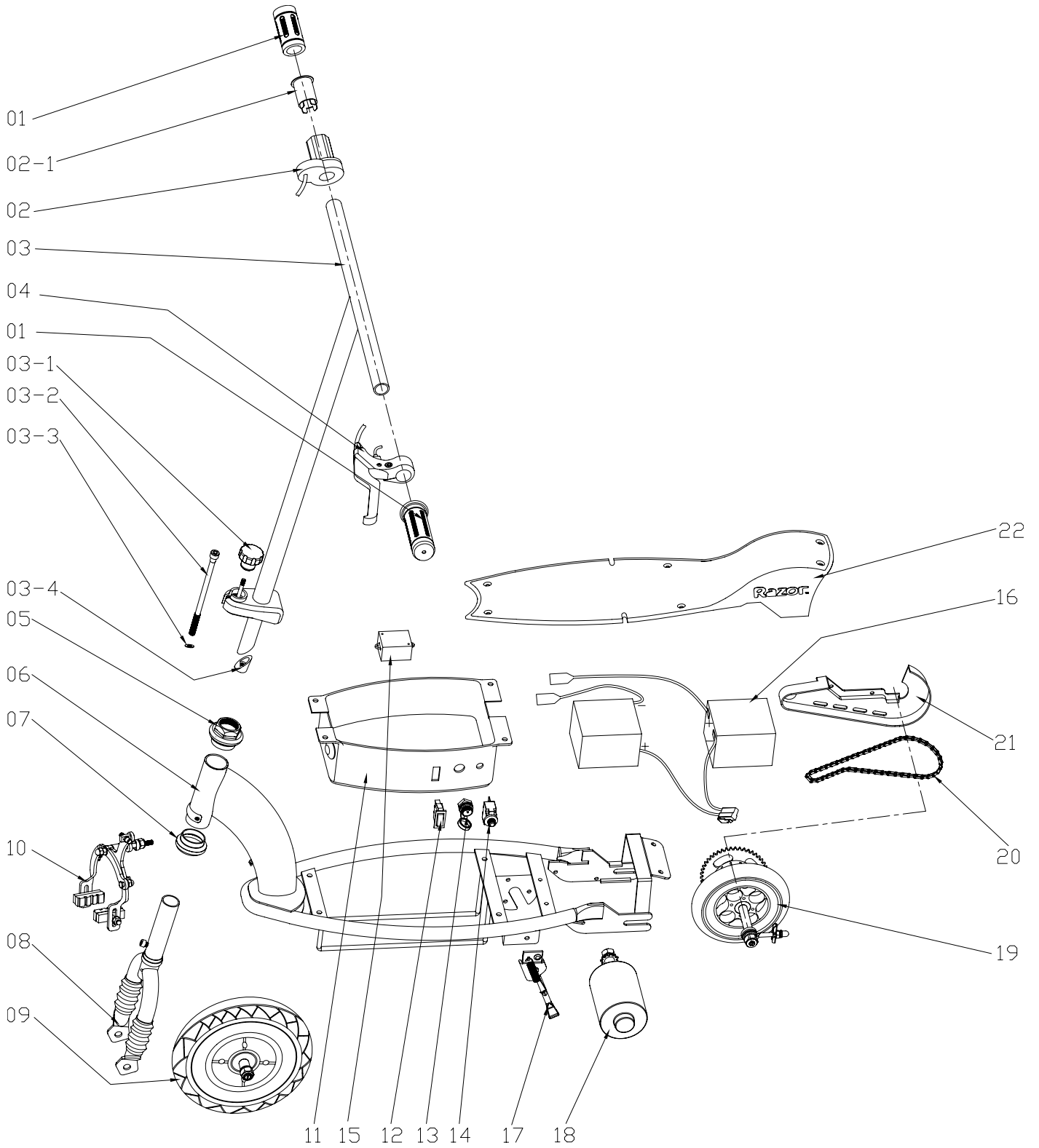

E150 PARTS

Keep your scooter running for years with genuine Razor parts. Visit our web site or e-mail us for more information on spare part availability. (Specifications subject to change without notice.)

- | | | | |
|------|------------------------------------|----|-------------------------|
| 01 | Handlebar grip (right/left) | 09 | Front wheel complete |
| 01-1 | Valve stem extender/ inflator | 10 | Battery tray |
| 01-2 | Handlebar end cap/ Extender holder | 11 | On/ Off switch |
| 02 | Brake lever assemble complete | 12 | Reset button w/ wire |
| 03 | Handlebar stem/ T-bar | 13 | Charger port w/ wires |
| 03-1 | Black folding knob | 14 | Control module |
| 03-2 | 6mm stem bolt | 15 | Battery (2- 12V/ 4.5Ah) |
| 03-3 | Washer | 16 | Motor (24V/ 100W) |
| 03-4 | Wedge | 17 | Kickstand |
| 04 | Speed controller w/ LEDs | 18 | Rear wheel complete |
| 04-1 | Sleeve | 19 | Chain |
| 05 | Headset (upper) | 20 | Chain guard |
| 06 | Frame | 21 | Deck, Upper plate |
| 07 | Headset (lower) | 22 | Main deck board |
| 08 | Front fork | | |

E150 PARTS

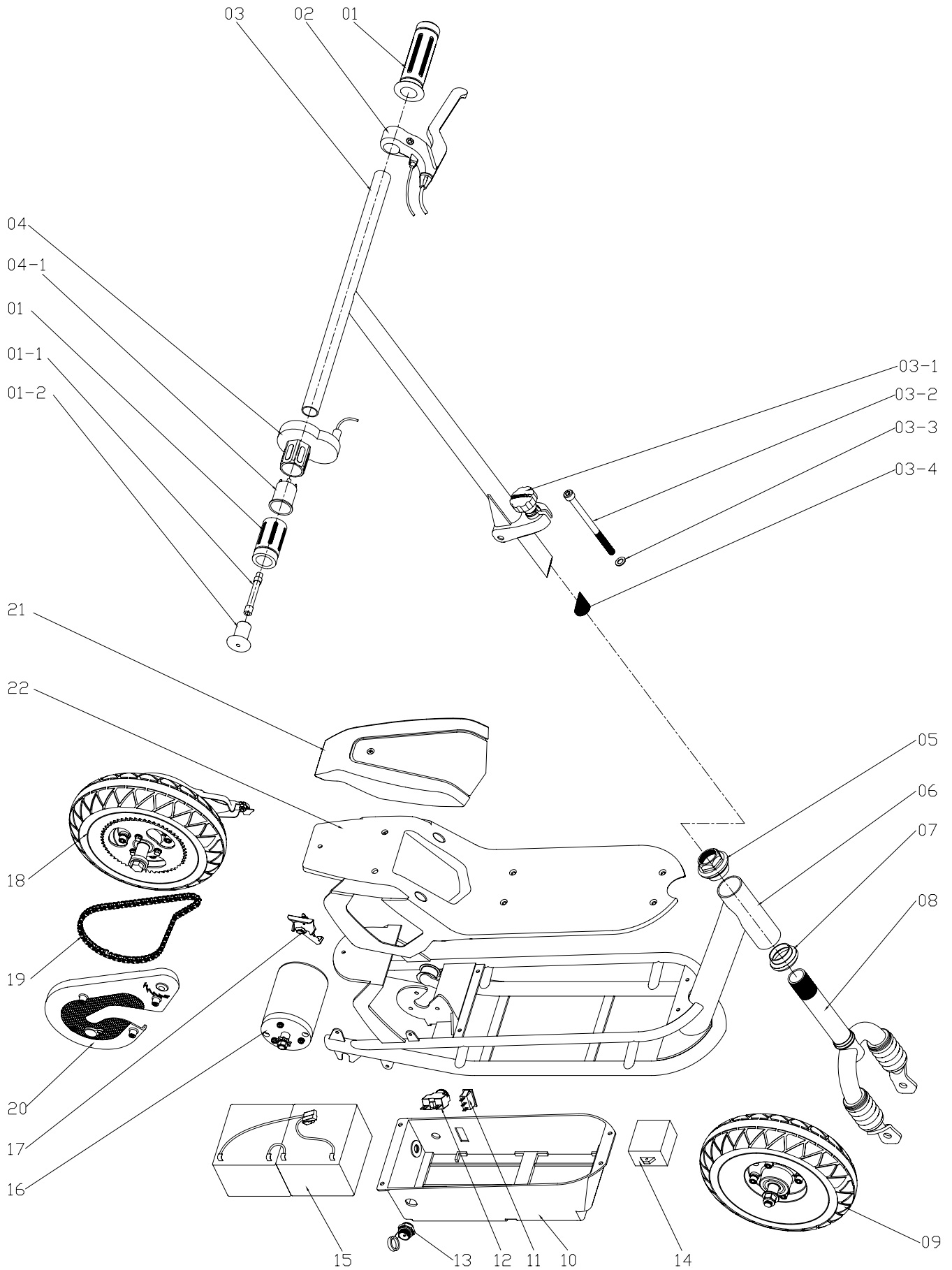

E200 PARTS

Keep your scooter running for years with genuine Razor parts. Visit our web site or e-mail us for more information on spare part availability. (Specifications subject to change without notice.)

- | | | | |
|------|------------------------------------|----|-----------------------|
| 01 | Handlebar Grip (right/left) | 11 | Front wheel complete |
| 01-1 | Valve stem extender/ inflator | 12 | Battery tray |
| 01-2 | Handlebar end cap, Extender holder | 13 | Reset button w/ wire |
| 02 | Speed controller w/ LEDs | 14 | On/ Off switch |
| 02-1 | Sleeve | 15 | Charger port w/ wires |
| 03 | T-bar | 16 | Control module |
| 04 | Brake lever assemble complete | 17 | Motor (24V/ 200W) |
| 05 | Quick release | 18 | Kickstand |
| 06 | Extension tube/ Folding system | 19 | Battery (2- 12V/ 7Ah) |
| 06-1 | Black folding knob | 20 | Rear wheel complete |
| 06-2 | 6mm stem bolt | 21 | Chain |
| 06-3 | Washer | 22 | Chain guard |
| 06-4 | Wedge | 23 | Rear fender |
| 07 | Headset (upper) | 24 | Deck |
| 08 | Frame | 25 | Seat post |
| 09 | Headset (lower) | 26 | Seat |
| 10 | Fork front | | |

E200 PARTS

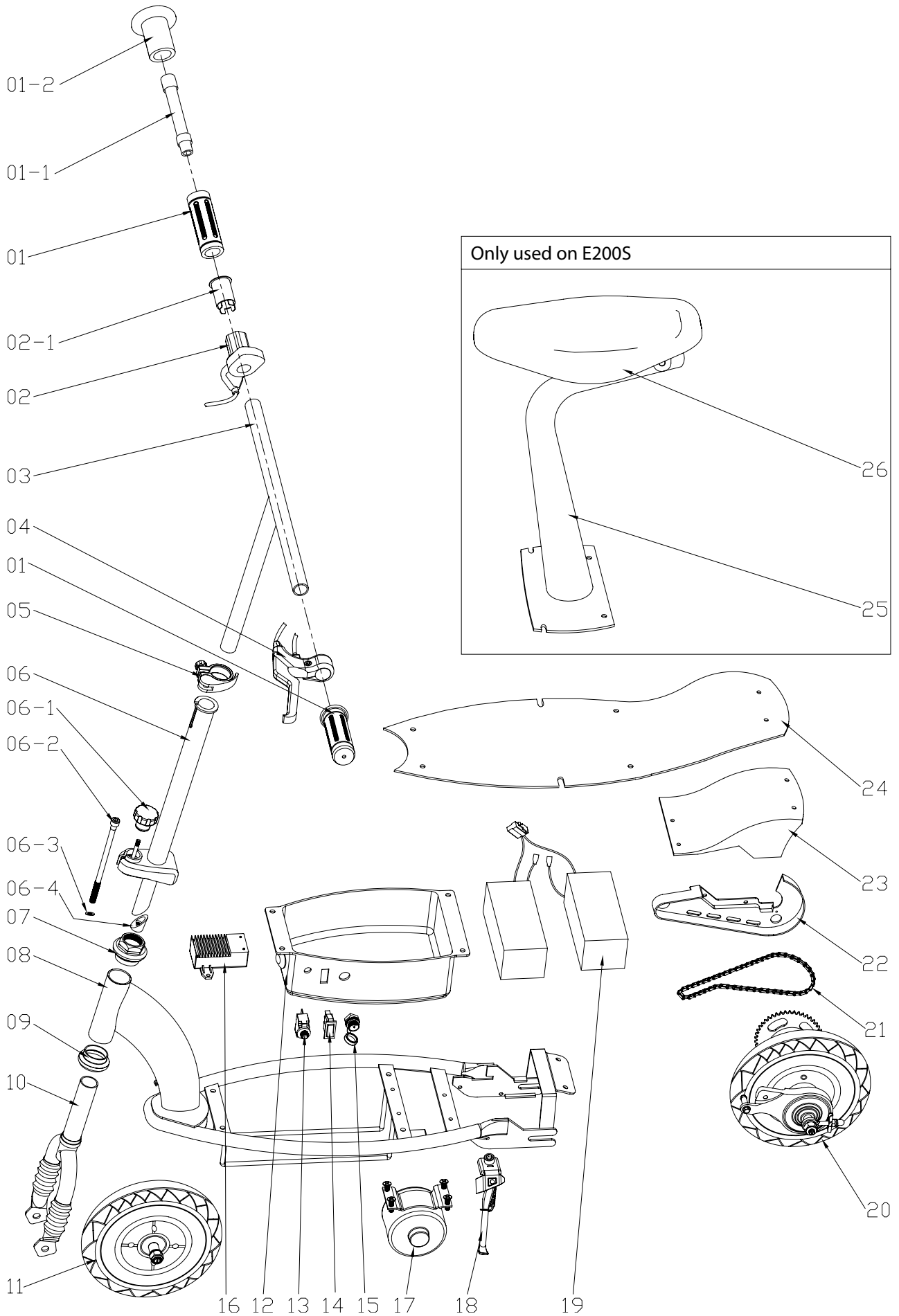

E300 PARTS

Keep your scooter running for years with genuine Razor parts. Visit our web site or e-mail us for more information on spare part availability. (Specifications subject to change without notice.)

- | | | | |
|------|------------------------------------|----|-------------------------|
| 01 | Handlebar grips (right/left) | 09 | Front wheel complete |
| 01-1 | Valve stem extender/ inflator | 10 | Battery tray |
| 01-2 | Handlebar end cap, Extender holder | 11 | Reset button |
| 02 | Single speed twist grip throttle | 12 | On/ off switch |
| 02-1 | Sleeve | 13 | Charger port w/ wires |
| 03 | Handlebar Stem/ T-bar | 14 | Control module |
| 03-1 | Black folding knob | 15 | Battery (2- 12V/ 7Ah) |
| 03-2 | 6mm stem bolt | 16 | Motor (24V/ 250W) |
| 03-3 | Washer | 17 | Kickstand |
| 03-4 | Wedge | 18 | Rear wheel complete |
| 04 | Brake lever assemble complete | 19 | Chain |
| 05 | Headset (upper) | 20 | Chain guard |
| 06 | Frame | 21 | Deck plate w/ grip tape |
| 07 | Headset (lower) | 22 | Seat post |
| 08 | Front fork | 23 | Seat |

E300 PARTS

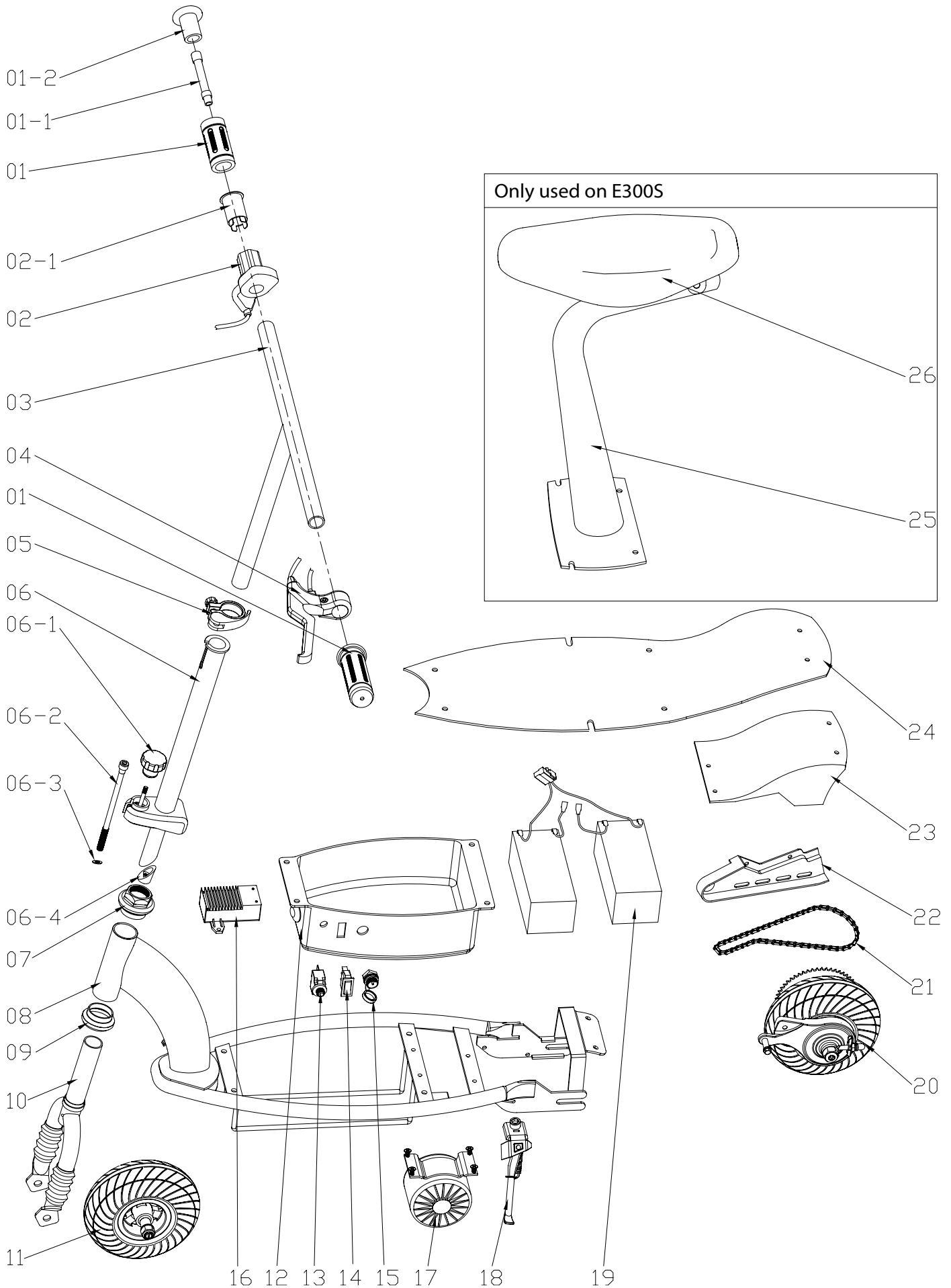

SB 1918 (CALIFORNIA) DECLARATION

YOUR INSURANCE POLICIES MAY NOT PROVIDE COVERAGE FOR ACCIDENTS INVOLVING THE USE OF THIS SCOOTER/ELECTRIC VEHICLE. TO DETERMINE IF COVERAGE IS PROVIDED, YOU SHOULD CONTACT YOUR INSURANCE COMPANY OR AGENT.

SAFETY REMINDERS

PRE-RIDE CHECKLIST



Loose Parts

Check and secure all fasteners before every ride. Make sure steering stem clamp bolts are locked properly in place. There should not be any unusual rattles or sounds from loose parts or broken components. If you are not sure, ask an experienced mechanic to check.



Tire Inflation

Periodically inspect the tires for excess wear, and regularly check the tire pressure and re-inflate as necessary. If you get a flat tire, the inner tube can be patched or a new tube can be purchased from Razor or an authorized repair center.



Brake

Check the brakes for proper function. When you squeeze the lever, the brake should provide positive braking action. When you apply the brake with the speed control on, the brake cut-off switch will stop the motor.



Safety Gear

Always wear proper protective equipment such as an approved safety helmet, elbow pads and kneepads. Always wear athletic shoes (lace-up shoes with rubber soles), never drive barefooted or in sandals, and keep shoelaces tied and out of the way of the wheels, motor and drive system.



Frame, Fork and Handlebars

Check for cracks or broken connections. Although broken frames are rare, it is possible for an aggressive driver to bash into a curb or wall and wreck and bend or break a frame. Get in the habit of inspecting yours regularly.

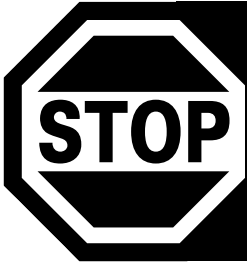

DO NOT RETURN TO STORE

Do not use this vehicle for the first time until you have inflated the tires to the correct PSI and charged the battery for at least 12 hours.

Failure to follow these instructions may damage your vehicle and void your warranty.

WARRANTY

Razor Limited Warranty

The manufacturer warrants this product to be free of manufacturing defects for a period of 90 days from date of purchase. This Limited Warranty does not cover normal wear and tear, tires, tubes or cables, or any damage, failure or loss caused by improper assembly, maintenance, or storage or use of the Razor electric chopper.

This Limited Warranty will be void if the product is ever

- used in a manner other than for recreation or transportation
- modified in any way;
- rented.

The manufacturer is not liable for incidental or consequential loss or damage due directly or indirectly to the use of this product.

Razor does not offer an extended warranty. If you have purchased an extended warranty, it must be honored by the store at which it was purchased.

For your records, save your original sales receipt with this manual and write the serial number below.

Item Numbers

E100	13100E-BL
E125	13125E-BK Black
	13111110 Red
E150	13111612
E200	13200E-SL
E200S	13201S-SL
E225S	13112850
E300	13300E-SL
E300S	13301S-SL
E325S	13116390

Need Help? Visit our web site for updates and a list of authorized service centers at www.razor.com or call toll-free at **866-467-2967** Monday - Friday 8:00 AM - 5:00 PM Pacific Time.

Community Design No. 130919-0001
U.S. Design Patent D497,397 S
Printed in China for:
Razor USA LLC
PO Box 3610
Cerritos, CA 90703
© Copyright 2007 Razor USA. All rights reserved.

12102007

Free Manuals Download Website

<http://myh66.com>

<http://usermanuals.us>

<http://www.somanuals.com>

<http://www.4manuals.cc>

<http://www.manual-lib.com>

<http://www.404manual.com>

<http://www.luxmanual.com>

<http://aubethermostatmanual.com>

Golf course search by state

<http://golfingnear.com>

Email search by domain

<http://emailbydomain.com>

Auto manuals search

<http://auto.somanuals.com>

TV manuals search

<http://tv.somanuals.com>