

**RCA**

**SCENIUM**

user's guide for:  
high-definition television

HD52W140 / HD61W140 / HD65W140



# Important Information

## WARNING

To reduce the risk of fire or electric shock, do not expose this product to rain or moisture.

## CAUTION

RISK OF ELECTRIC SHOCK  
DO NOT OPEN

Caution: To reduce the risk of electric shock, do not remove cover (or back). No user serviceable parts inside. Refer servicing to qualified service personnel.



This symbol indicates "dangerous voltage" inside the product that presents a risk of electric shock or personal injury.



This symbol indicates important instructions accompanying the product.

Refer to the identification/rating label located on the back panel of your product for its proper operating voltage.

FCC Regulations state that unauthorized changes or modifications to this equipment may void the user's authority to operate it.

**Caution: Using video games or any external accessory with fixed images for extended periods of time can cause them to be permanently imprinted on the picture tube (or projection TV picture tubes). ALSO, some network/program logos, phone numbers, black borders (sides, top, bottom) etc. may cause similar damage. This damage is not covered by your warranty.**

**Cable TV Installer:** This reminder is provided to call your attention to Article 820-40 of the National Electrical Code (Section 54 of the Canadian Electrical Code, Part 1) which provides guidelines for proper grounding and, in particular, specifies that the cable ground shall be connected to the grounding system of the building as close to the point of cable entry as practical.

## Product Registration

Please fill out the product registration card (packed separately) and return it immediately. Returning the card allows us to contact you if needed.

## Product Information

Keep your sales receipt to obtain warranty parts and service and for proof of purchase. Attach it here and record the serial and model numbers in case you need them. These numbers are located on the product.

Model No. \_\_\_\_\_

Serial No. \_\_\_\_\_

Purchase Date: \_\_\_\_\_

Dealer/Address/Phone: \_\_\_\_\_

VCR Plus+, C<sup>3</sup>, PlusCode, G-LINK, and GUIDE Plus are trademarks of Gemstar Development Corporation.

The VCR Plus+ and GUIDE Plus+ systems are manufactured under license from Gemstar Development Corporation and VCR Index Systems B.V., respectively.

**THOMSON MULTIMEDIA INC. AND GEMSTAR ARE NOT IN ANY WAY LIABLE FOR THE ACCURACY OF THE PROGRAM SCHEDULE INFORMATION PROVIDED BY THE GUIDE PLUS+ SYSTEM. IN NO EVENT SHALL THOMSON MULTIMEDIA OR GEMSTAR BE LIABLE FOR ANY AMOUNTS REPRESENTING LOSS OF PROFITS, LOSS OF BUSINESS, OR INDIRECT, SPECIAL, OR CONSEQUENTIAL DAMAGES IN CONNECTION WITH THE PROVISION OR USE OF ANY INFORMATION EQUIPMENT, OR SERVICES RELATING TO THE GUIDE PLUS+ SYSTEM.**

VCR required for recording.

## Key Features Overview

Your TV is equipped with features that will add to your TV viewing experience. The following information summarizes a few of these features. Chapter 3 provides more information about the rest of the TV's features and how to use them.

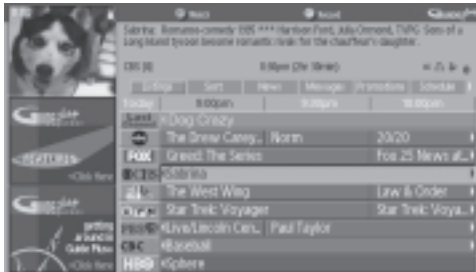

### On-screen Program Guide

The GUIDE Plus+ system is a “no-fee,” on-screen interactive list of programs and information that is built into your TV. You can scroll through the guide to see what's on and tune directly to that program from the guide. You can also browse programs by category with the *Sort* feature or sort them alphabetically. When you access the *News* feature, MSNBC will appear in your video window if available and display current news stories by headline. One-Touch VCR Recording is another benefit of the GUIDE Plus+ system. You don't have to remember to program your VCR or use the menus in your VCR to set up a recording.

Complete the on-screen assisted setup. You'll find detailed instructions in Chapter 1.



### V-Chip: Parental Controls

You can block programs and movies by content, age-based ratings, and/or movie ratings. Set up the *Parental Controls* menu in the TV's main menu (Chapter 3 has details). The broadcasters must use the rating system when they send the program to your TV in order for your TV to block the program. The TV must be locked for the parental controls settings to take effect.



### DTVLink® (Digital Television Link)

Better known to some as IEEE 1394 or FireWire\*, these jacks enable connection of high-speed digital technology to devices with a DTVLink logo on them. With the two DTVLink connectors, you can network your digital devices by linking them together.

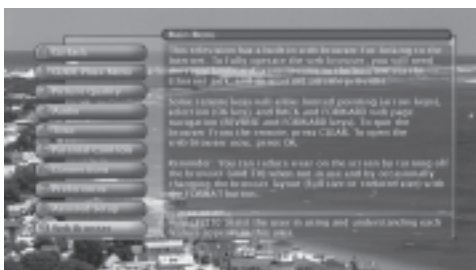

### Web Browser

A web browsing software package is built into your television that allows access to the Internet including the W.W.W. The browser interprets HTML (HyperText Markup Language), the programming language of the Internet, into the words and graphics (jpeg and gif files) that you see when viewing a web page. This browser has some limitations and might not be equipped to interpret all files, such as streaming video and audio. You'll need a high-speed connection, such as a DSL (digital subscriber line) unit or cable modem to use the web browser.

DTVLink® Certification Logo is a U.S. registered mark of CEA.

\*FireWire is a trademark of Apple Computer, Inc., registered in the U.S. and other countries.

# Introduction

---



## Record Output Jacks

You can record digital TV (and analog) programs by using the RECORD OUTPUT VIDEO OUT and AUDIO OUT L/R (you can also record analog programs). Your TV must be tuned to the channel in order to record the program.



## Integrated HDTV Tuner

Decodes all 16 formats of ATSC Digital TV broadcasts for a clearer picture without ghosting or snow. Decodes NTSC analog TV broadcasts. For digital TV, can output sound in Dolby Digital 5.1 and pictures in 16:9 widescreen (if the broadcast supports it).

## Menu Path

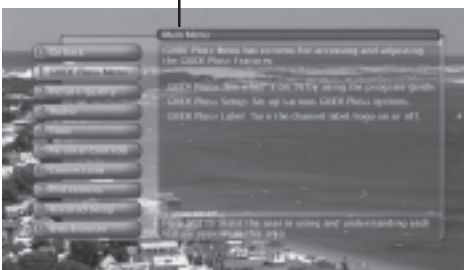

## On-Screen Help Text

The elaborate on-screen help text along with the user's guide assists you in learning to use the features of your television. A menu path appears at the top of the screen to remind you where you are in the menu system. The help text consists of step-by-step instructions, definitions, information, tips, etc.

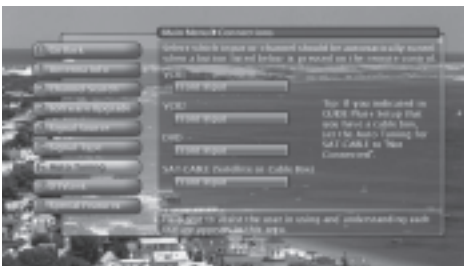

## Auto Tuning

The *Auto Tuning* feature allows you to set up the TV to tune to a specific channel when you press a certain component (VCR, DVD Player, etc.) button on the remote. See Chapter 3 for details.

## Introduction

Key Features Overview .....	1
-----------------------------	---

## Chapter 1: Connections & Setup

Things to Consider Before You Connect .....	6
Choose Your Connection .....	7
How to Connect: TV + VCR + DVD Player .....	8
How to Connect: TV + Satellite Receiver + VCR .....	9
How to Connect: Dolby Digital Receiver + Speakers .....	10
How to Connect: A/V Amplifier/Receiver + Speakers .....	10
How to Connect: TV + Speakers .....	11
Explanation of Input Jacks and Cables .....	12
Back of the TV .....	14
Why You Should Connect the G-LINK Cable .....	17
How to Find the Remote Sensor .....	17
Placing the G-LINK Wands .....	17
The Front of Your TV .....	18
Front Inputs.....	18
Front Panel .....	18
Plug in the TV.....	19
Put batteries in the remote .....	19
Turn on the TV .....	19
Complete the Assisted Setup .....	20
Set the Menu Language .....	20
Complete Channel Search .....	20
The GUIDE Plus+ System Setup .....	20
What to Expect .....	24
Next Steps .....	24

## Chapter 2: Using the Remote Control

The Buttons on the Remote Control .....	26
Programming the Remote to Operate Other Components .....	28
Using the Input Button .....	30
Code List .....	31

## Chapter 3: Using the TV's Features

About the Channel Banner .....	34
Digital or Analog TV Channel .....	35
About the GUIDE Plus+ System .....	36
Parental Controls .....	40
Lock/Unlock TV .....	40
Channel Lists .....	40
How V-Chip Works .....	41
V-Chip Unrated Program Block .....	45
Front Button Block .....	45
Web Browser Block .....	45
Auto Tuning Feature .....	46
PIP (Picture-in-Picture) Operation .....	47
Using the Web Browser .....	48
Browser Screen Burn Prevention .....	49
Saving Your Favorite URLs .....	49
Controlling the Web Browser .....	49

# Table of Contents

---

## Chapter 4: Using the TV's Menu System

<b>Menus, On-screen Help and Control Panels</b> .....	<b>52</b>
Exiting a menu .....	52
On-Screen Help .....	52
Control Panels .....	52
<b>Picture Quality Menu</b> .....	<b>54</b>
Picture Settings .....	54
Picture Presets .....	54
Auto Color .....	55
Color Warmth .....	55
Noise Filter .....	55
Convergence .....	55
SVM .....	56
Reset Controls .....	56
<b>Audio Menu</b> .....	<b>56</b>
Graphic Equalizer .....	56
Audio Processor .....	57
Sound Logic.....	57
Audio Language .....	57
SAP (Second Audio Program) .....	58
Balance .....	58
Fixed/Variable Out .....	58
Digital Audio Out .....	59
Subwoofer.....	59
<b>Time Menu</b> .....	<b>59</b>
<b>Connections Menu</b> .....	<b>59</b>
Antenna Info.....	59
Channel Search .....	60
Software Upgrade .....	60
Signal Source.....	60
Signal Type .....	61
Auto Tuning .....	61
DTVLINK® (Digital Television Link) .....	61
Special Features .....	61
Ethernet Setup.....	62
<b>Preferences Menu</b> .....	<b>62</b>
Closed Captioning .....	62
Screen Format .....	64
Record Output .....	64
Color Scheme .....	64
Translucency .....	65
Menu Language.....	65
Digital Channel Info .....	65

## Chapter 5: Reference

<b>Troubleshooting</b> .....	<b>68</b>
<b>Accessory Information</b> .....	<b>74</b>
<b>Limited Warranty</b> .....	<b>77</b>
<b>Care and Cleaning</b> .....	<b>78</b>
<b>Index</b> .....	<b>79</b>

# Connections & Setup

## Chapter Overview:

- Things to Consider Before You Connect
- Choose Your Connection
- How To Connect
- Back of the TV
- Why You Should Connect the G-LINK Cable
- The Front of Your TV
- Plug in the TV
- Put Batteries in the Remote
- How to Use the Remote Control to Complete the Assisted Setup
- Turn on the TV
- Complete the Assisted Setup

SCENIUM

## Things to Consider Before You Connect

### Protect Against Power Surges

- Connect all components before you plug any of their power cords into the wall outlet or power strip. NEVER plug your TV into an outlet that is controlled by a wall switch.
- Turn off the TV and/or component(s) before you connect or disconnect any cables.
- Make sure all antennas and cables are properly grounded. Refer to the Important Safeguards sheet packed with your TV.

### Protect Components from Overheating

- Don't block ventilation holes on any of the components. Arrange the components so that air can circulate freely.
- Don't stack components.
- When you place components in a stand, make sure you allow adequate ventilation.
- If you connect an audio receiver or amplifier, place it on the top shelf so the heated air from it won't flow around other components.

### Position Cables Properly to Avoid Audio Interference

- Insert each cable firmly into the designated jack.

### Use Indirect Light

Don't place the TV where sunlight or room lighting will be directed toward the screen. Use soft or indirect lighting.







### Connection Illustrations

The components used in the connection illustrations are for representation only. The input jacks and the output jacks on the back of your components (VCR, DVD player, etc.,) might look different than those illustrated.

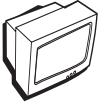

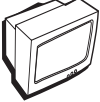
## Choose Your Connection

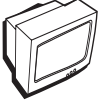
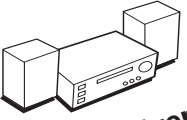
There are several ways to connect your television, depending on the components you want to connect and the quality of the signal you want to achieve. Please use the following chart to determine which connection is best for you. Proceed to the appropriate page and connect your TV. For more information about the relationship between the cables, jacks, and the quality of the signal you see on your TV, go to page 12.

Components			Cables Needed	Connection Title	Go to...
 TV	 DVD	 VCR	Coaxial Audio/video G-LINK Component	TV + DVD + VCR	page 8
 TV	 Satellite Receiver	 VCR	Coaxial Audio/video G-LINK	TV + Satellite Receiver + VCR	page 9
 TV	 A/V Receiver	 VCR	Coaxial Audio/video G-LINK	TV + A/V Receiver + VCR	page 10

## Cables You Need to Connect Components to Your TV

The pictures below show the cables you may need for the connections represented in this book.

**Note:** Please locate the G-LINK cable (provided) when you're getting ready to set up your TV. You need to connect this cable to your TV and to your VCR and/or cable box in order for all of the features of the program guide to work properly.



G-LINK cable

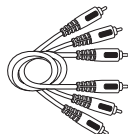

Composite Video  
Audio/ Video cables

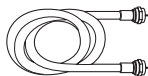

Coaxial cable

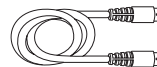

S-Video cable

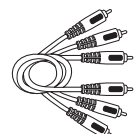

Component Video  
Y•Pb•Pr cables

# Connections & Setup

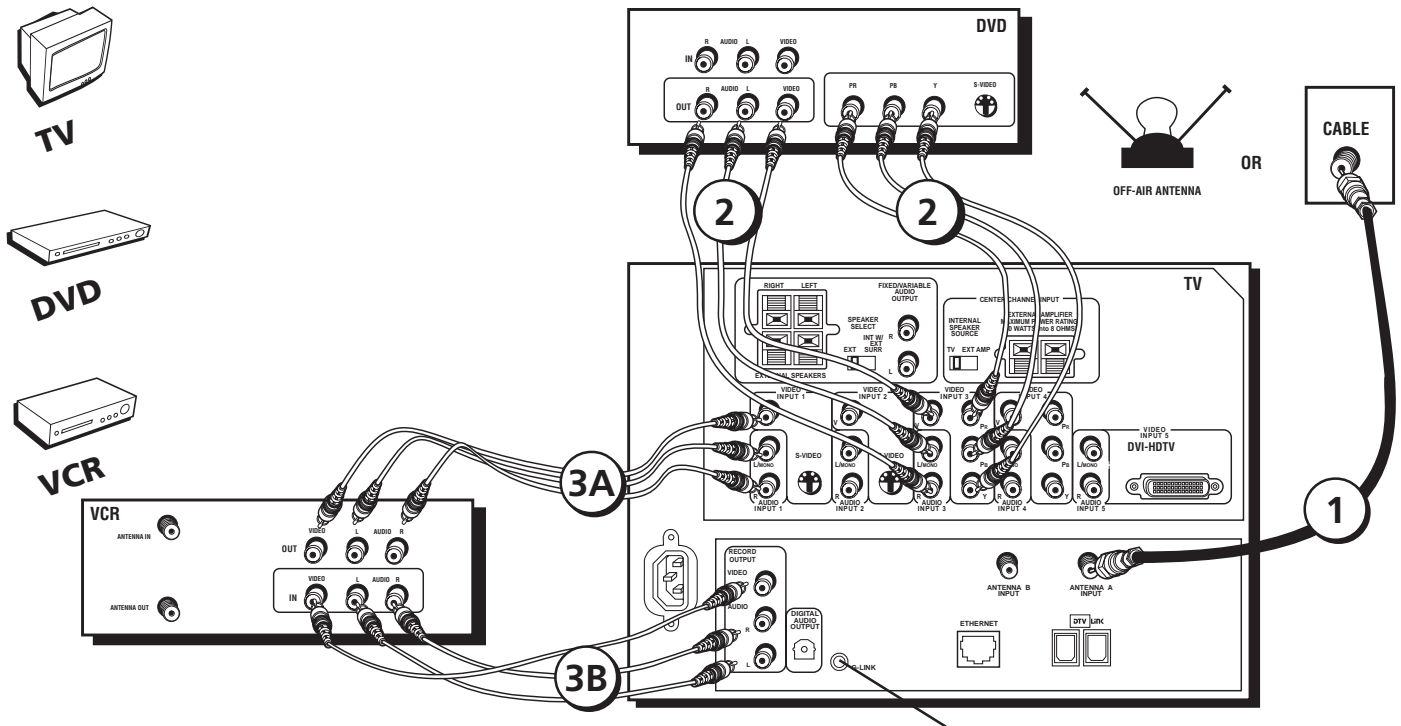

Connect G-LINK Cable (see page 17)

## How to Connect: TV + VCR + DVD Player

### 1. Connect your cable or off-air signal to ANTENNA A.

If you have cable and off-air antennas, connect the cable signal to ANTENNA A INPUT (antenna A is the only source for GUIDE Plus+ System). Connect the off-air antenna to ANTENNA B INPUT. If you have only an off-air antenna, connect it to ANTENNA A INPUT.

### 2. Connect your DVD Player to your TV.

Connect the DVD player's component and audio outputs to INPUT 3 on the TV using component cables (connecting the video jack does not affect the component connection). If your DVD player has composite audio/video and an S-Video output, use INPUTs 1 or 2 and use the S-Video jack instead of the video jack.

**Notes:** If you are using an S-Video cable (INPUT 1 or 2) or component video cables, you must also use audio cables. The S-Video cable and component video cables only transfers video information.

If your DVD player has a component video output, we recommend you use the component video input on the TV instead of the composite video or S-Video connection. Don't forget to also connect audio cables when using the component video cables.

### 3. Connect your VCR to your TV.

A. Connect the VCR's audio/video outputs to INPUT 1 (audio/video) on the TV using composite audio/video cables.

B. Connect the VCR's audio/video inputs to RECORD OUTPUT on the TV. This enables recording of digital programs (unless copy protected, using DVI HDTV or component video formats), as well as analog programs.

## Viewing the Components

1. Turn on the TV and the component(s) you want to view.
2. Press the TV button on the remote control.
3. Press the INPUT button on the remote control to scroll through the video inputs.
  - The VCR can be viewed on the INPUT 1 channel.
  - The DVD player can be viewed on the INPUT 3 channel.

**Note:** You can set up the TV to automatically tune to the correct input channel. This is called Auto Tuning. (See Chapter 3 for more information.)

Go to page 17

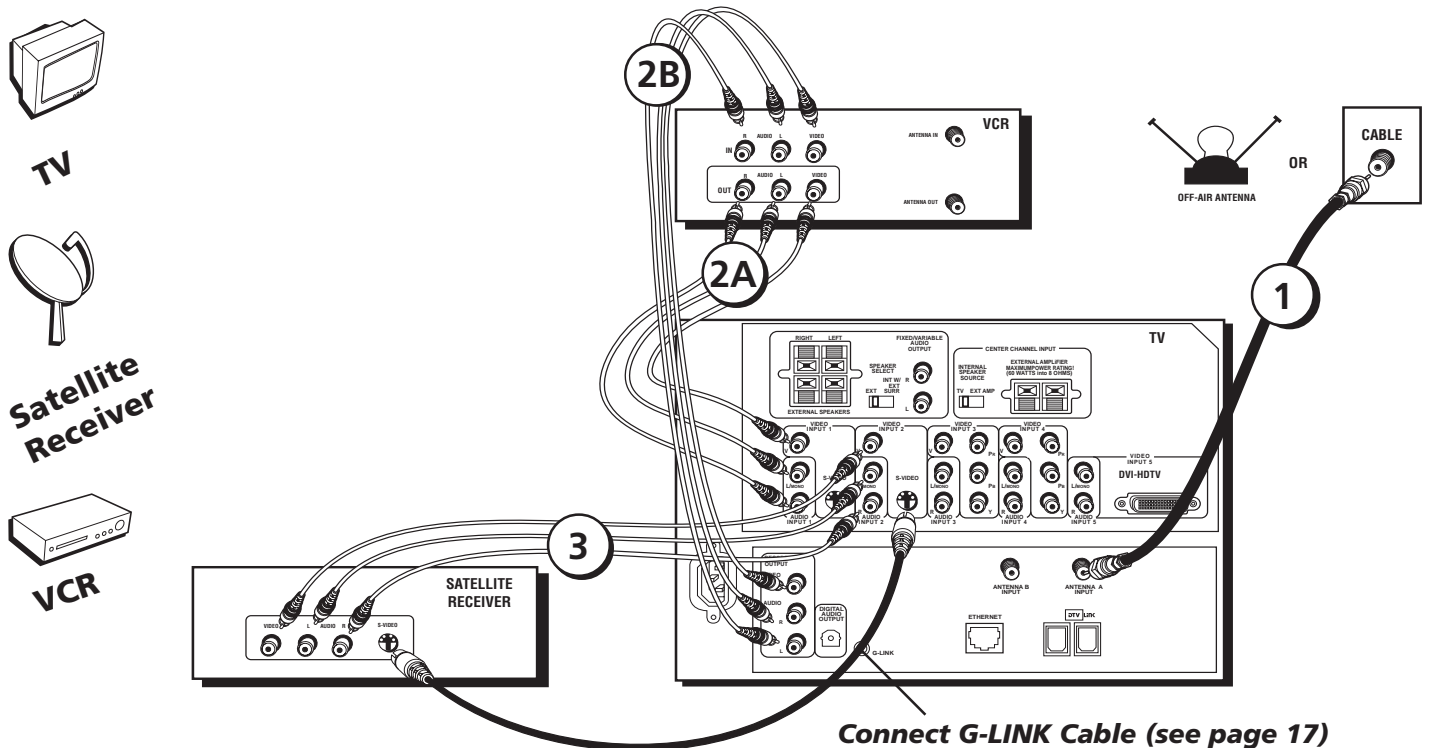

## How to Connect: TV + Satellite Receiver + VCR

### 1. Connect your cable or off-air signal to ANTENNA A.

If you have cable and off-air antennas, connect the cable signal to ANTENNA A INPUT (antenna A is the only source for GUIDE Plus+ System). Connect the off-air antenna to ANTENNA B INPUT. If you have only an off-air antenna, connect it to ANTENNA A INPUT.

### 2. Connect your VCR to your TV.

A. Connect the VCR's audio/video outputs to INPUT 1 (audio/video) on the TV using composite audio/video cables.

B. Connect the VCR's audio/video inputs to RECORD OUTPUT on the TV. This enables recording of digital programs (unless copy protected, using DVI HDTV or component video formats), as well as analog programs.

### 3. Connect your Satellite Receiver to your TV.

Connect the satellite receiver's audio/video output jacks to the INPUT 2 AUDIO (R and L) and VIDEO jacks on the TV using composite cables. If your satellite receiver has an S-Video output, you can make the video connection by using the S-Video jacks instead. If your satellite receiver has component outputs, then use INPUT 3 or 4.

**Note:** If you are using an S-Video cable or component video cables, you must also use audio cables. The S-Video cable and component video cables only transfers video information.

## Viewing the Components

1. Turn on the TV and the component(s) you want to view.
2. Press the TV button on the remote control.
3. Press the INPUT button on the remote control to scroll through the video inputs.
  - The VCR can be viewed on the INPUT 1 channel.
  - The satellite receiver can be viewed on the INPUT 2 channel.

**Note:** You can set up the TV to automatically tune to the correct input channel. This is called Auto Tuning. (See Chapter 3 for more information.)

**Go to page 17**

# Connections & Setup

## How to Connect: Dolby Digital Receiver + Speakers

If you own a Dolby Digital® or PCM (Pulse-Code Modulation) receiver that uses an optical cable-type input, connect an optical cable for excellent audio quality. Connect one end of the optical cable to the DIGITAL AUDIO OUT jack on your TV to the Optical Input Jack on your receiver/amplifier receiver. Consult your Dolby Digital receiver manual to complete speaker hookup to the receiver.

You might want to switch INTERNAL SPEAKER SOURCE to EXT AMP and connect the audio receiver's CENTER SPEAKER OUTPUT to the TV's EXT AMP input to use the TV's internal speakers as a center speaker.

- Go to *Audio* menu and select *Audio Select* if your receiver can decode DD and PCM.
- Go to *Audio* menu and select PCM if your receiver can decode only PCM.

## How to Connect: A/V Amplifier/Receiver + Speakers

1. Connect the FIXED/VARIABLE AUDIO OUTPUT from the TV to an A/V amplifier/receiver using audio cables.
2. Be sure to go to the *Fixed/Variable Out* screen in the *Audio* menu and select whether you want the FIXED/VARIABLE AUDIO OUTPUT jacks to send fixed volume audio or variable volume audio.
  - *Fixed Output* provides fixed-level audio output from the TV. This audio output is ideal for connecting to an A/V receiver that has its own volume control.
  - *Variable Output* provides variable-level audio output. Volume levels are controlled by the volume controls on the TV and TV remote control.
3. Use speaker wire to connect the TV to external speakers.
  - The EXT/INT W/EXT SURR switch beside the jacks lets you turn the TV's internal speakers on or off. The default position of the switch is INT W/EXT SURR.
  - If you connect speakers and place the switch in the INT W/EXT SURR position, you get audio from the internal speakers as well as L minus R from both external speakers. This connection gives you a matrix surround effect.
  - If you connect speakers and place the switch in the EXT position, you get audio from the external speakers only. The TV's internal speakers are turned off.

**Notes:** The external speaker rating is 8 ohms with 30 watts total power handling capabilities.

**Subwoofer status is not affected by the EXT/INT W/EXT SURR switch setting.**

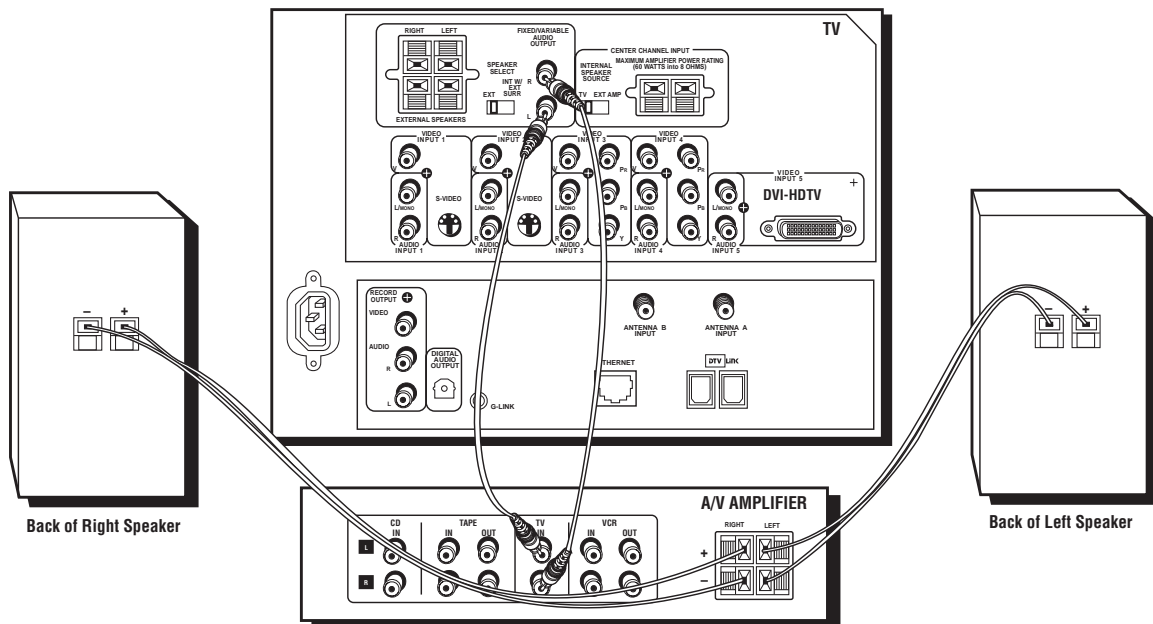

\*"Dolby", "Pro Logic", and the double-D symbol are trademarks of Dolby Laboratories.

## How to Connect: TV + Speakers

You can connect up to two additional speakers to the TV: one to the RIGHT terminal, and one to the LEFT terminal.

1. If necessary, remove the vinyl covering from the ends of the speaker wire and twist the wire core.
2. Open the lever on the speaker terminal.
3. Insert the wire core into the hole. Be sure to connect the (+) to (+) and (-) to (-).
4. Close the lever. Pull gently on the wire to see that it's connected securely.
5. Place the SPEAKER SELECT EXT/INT W/EXT SURR switch is in the INT W/EXT SURR position to hear the TV's internal speakers.
6. Go to the *Audio* menu and *Fixed/Variable Out* screen and make sure *Variable Out - Speakers* *On* is selected.

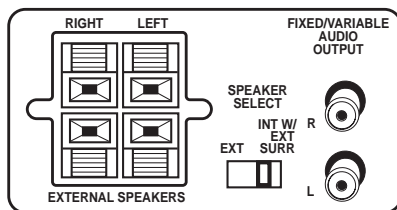
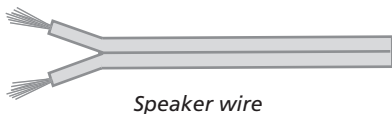

**Notes:** When connecting the speaker wire, make sure you connect the positive (+) terminal on the TV to the positive (+) terminal on the speaker. One side of the speaker wire is usually marked with a white stripe to help you match the terminals correctly. If the (+) and (-) terminals are not matched properly, the speakers will not be "in phase," causing reduction in bass frequencies.

Do not allow the wire core to touch other wires or terminals. Damage to components could result if the cores of two wires touch.

Arrange the speakers in your TV room to achieve maximum sound quality.

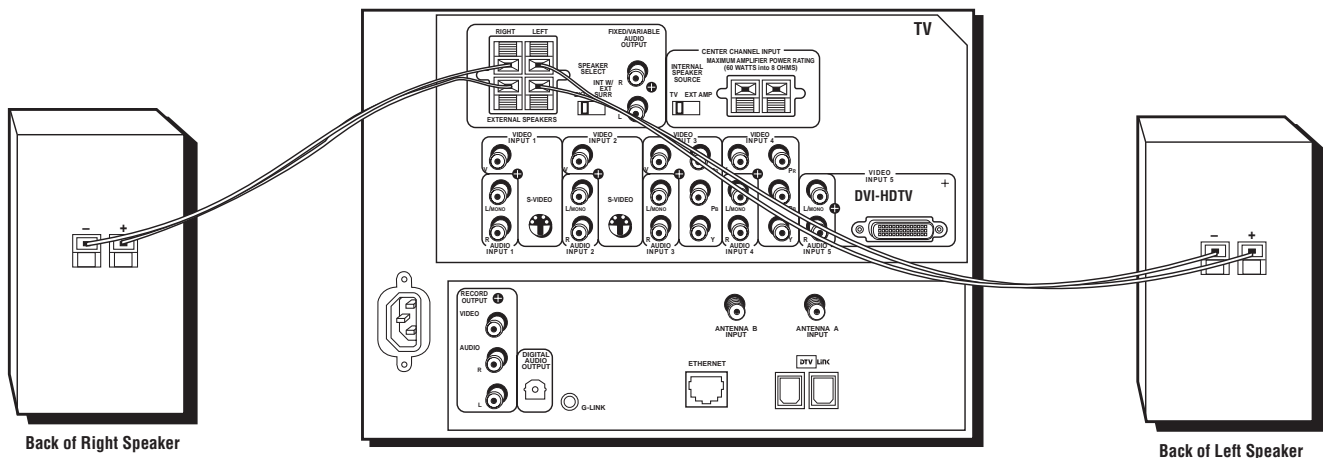

## Explanation of Input Jacks and Cables

This section describes the jacks and cables you might use to make connections (cables may be ordered separately by using the order form on page 75). There are several ways to connect components to your TV.

Different jacks and cables provide a different level of performance. It's important to remember the different degrees of picture improvement for comparison. If you use the DVI-HDTV and DTV LINK, the picture improvement can be noticeable depending on the source material. The component jacks are considered an excellent improvement; S-Video and composite jacks are considered very good while the antenna RF connection is good.

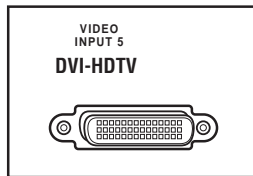

### DVI-HDTV (Digital Visual Interface-High Definition Television) Connector

DVI-HDTV is an uncompressed, digital video interface designed to deliver digital video in its native format. It supports the overlay of high-resolution graphics used by some program guides and interactive devices. The signal speed through a DVI-HDTV interface reaches 1.78 gigabits per second with high-definition video. Audio information is carried separately

**Note:** Remember to connect the left and right audio cables because the S-Video cable carries only the picture signal, not the sound.



### DTVLink® (Digital Television Link) Connectors

DTVLink is a compressed digital video input offering an IEEE-1394 type video connection from consumer devices such as satellite receivers, cable receivers, and digital recorders that meet the CEA specifications for DTVLink. DTVLink is better known to some as 1394 or FireWire for digital televisions. If your 1394 device has the DTVLink logo on it, it should work with this TV. Audio and video information is carried on a single wire. You can use either or both connectors to link your devices.

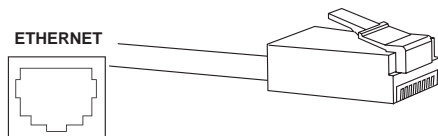

### Ethernet Jack and Cable

This jack is used to connect a router, cable modem or DSL (Digital Subscriber Line) unit.

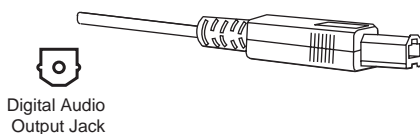

### Digital Audio Out Jack and Optical Cable

The optical cable is used to connect a Dolby Digital or PCM receiver to your TV. If you own a Dolby Digital or PCM receiver that uses an optical cable input, you can use an optical cable to connect the TV to that receiver for the best sound quality.

**Note:** This TV's optical digital output jack fully complies with the international standard governing this type of jack (IEC958), and is designed for connection to a Dolby Digital (AC-3® or PCM) receiver or Dolby Digital (AC-3 or PCM) decoder. Older equipment, some of which is not fully compliant with IEC958, may not be compatible with the Dolby Digital bitstream. Such a connection using anything other than Dolby Digital (AC-3 or PCM) receiver or decoder could create a high noise level, causing damage to headphones or speakers.

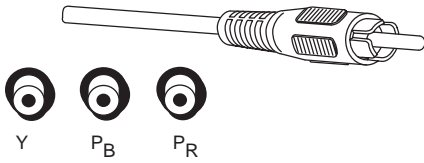

## Component Video (Y•Pb•Pr) Jacks and Cables

The Y•Pb•Pr jacks allow you to connect an optional component video source, such as a DVD player. This connection provides excellent picture quality because the video is separated into three signals. To ensure maximum picture quality, use three video-grade cables for the connection.

**Note:** Also, remember to connect the left and right audio cables because the Y•Pb•Pr cables carry only the picture signal, not the sound.

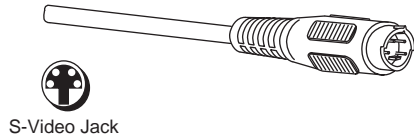

## S-Video Jacks and Cables

The S-Video (super video) jacks provide better picture quality than the regular video jacks because the color (chrominance, also called chroma) part of the signal is separated from the black and white (luminance) part of the picture.

If a component you're connecting to your TV (like a DVD player) has an S-VIDEO jack and composite video, connect the DVD player to the TV with an S-Video cable (not provided) for a better quality picture.

**Note:** Remember to connect the left and right audio cables because the S-Video cable carries only the picture signal, not the sound.

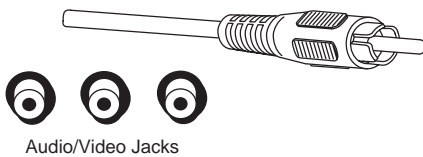

## Composite Audio/Video Jacks and Cables (RCA-type)

These jacks are used for most audio/video connections between components. The audio/video jacks are often color coded (yellow for video, red for right audio, and white for left audio). This is also called composite video.

**Note:** If your component has only one output for audio (mono), connect it to the left (white L/Mono) audio jack on the TV and don't connect the right audio part of the cable.

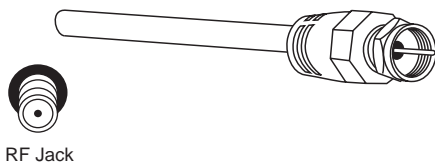

## RF Jacks and Coaxial Cables (F-type)

RF jacks are used for reception of off-air broadcasts and cable signals or for connecting components that have only RF outputs. The RF and coaxial jacks on the TV are labeled ANTENNA A INPUT and ANTENNA B INPUT.

# Connections & Setup

## Back of the TV

The diagrams below illustrate each of the back panel jacks found on the TV. When connecting cables, be sure to connect corresponding outputs and inputs (video to video, right audio to right audio, etc.).

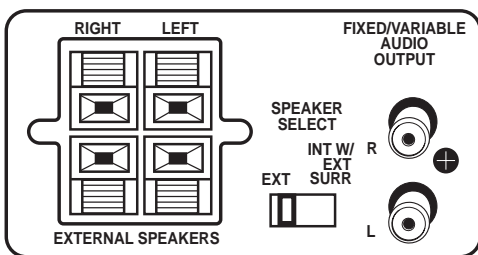
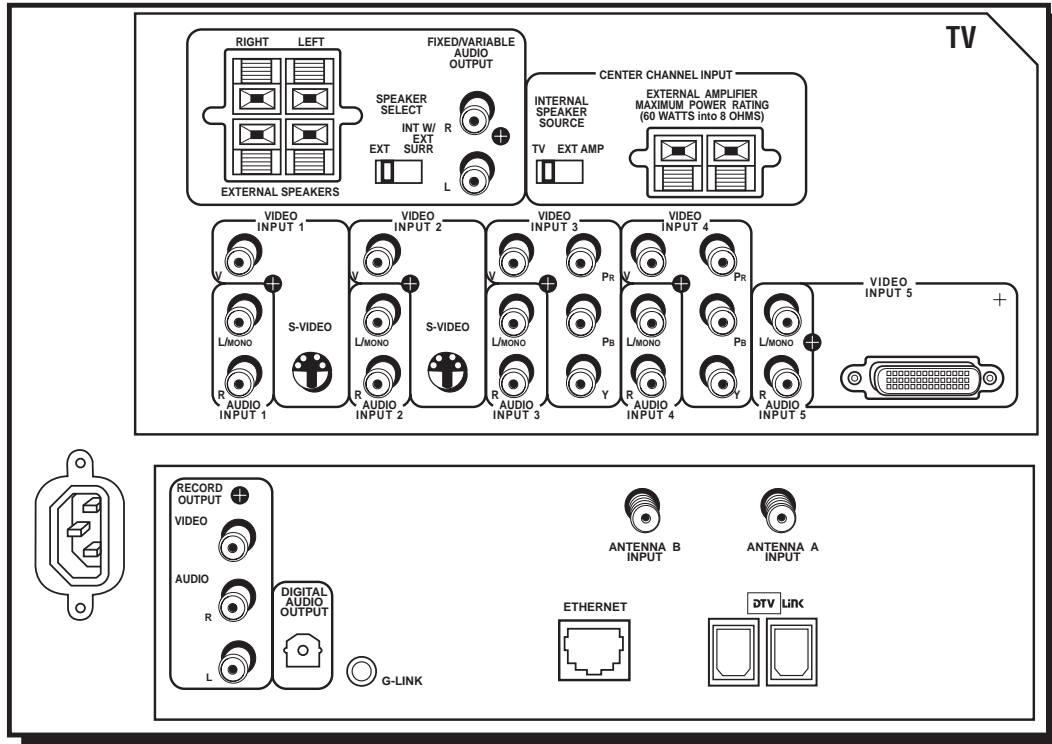

### AUDIO OUTPUTS

- **RIGHT and LEFT EXTERNAL SPEAKER Terminals** Used to connect external speakers for improved right and left sound, or surround sound. See page 10.
- **SPEAKER SELECT - EXT. or INT W/EXT SURR Switch** Lets you direct where the output of the TV's internal speakers goes. With the switch in the EXT position, you hear the TV's external speakers. In INT W/EXT SURR position, you hear the internal and external speakers

**Note:** To turn the TV's internal speakers on and off, press MENU on the remote control and choose Audio. Then choose Fixed/Variable Out from the menu and choose an option.

- **FIXED/VARIABLE AUDIO OUTPUT L/R** Provides fixed-level or variable-level audio output from the television. Fixed (*Fixed/Variable* is a menu setting) audio output is ideal for audio recording or for connecting to an A/V receiver amplifier (an auxiliary baseband component) when you want to control the volume through the A/V receiver instead of the TV. Variable is used to connect an A/V receiver or amplifier (an auxiliary baseband component) for variably-controlled stereo output.



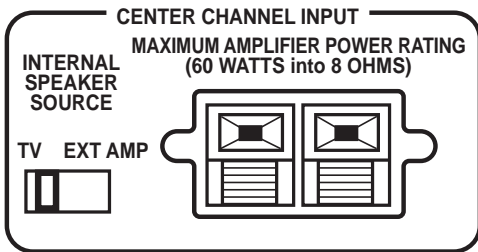

**Note:** The subwoofer is turned on or off via Audio Subwoofer menu.

## CENTER SPEAKER INPUT

- **INTERNAL SPEAKER SOURCE - TV / EXT AMP Switch** With the switch in the TV position, the TV's sound comes out of the internal speakers. With the switch in the EXT AMP position, the internal speakers are used for an external center channel. An external amplifier/receiver can be connected to the center channel input and the center channel audio comes out of the TV's internal speakers.
- **CENTER CHANNEL INPUT** Used to connect a center channel output from an audio receiver to the TV. If in use, switch the INTERNAL SPEAKER SOURCE to EXT AMP position.

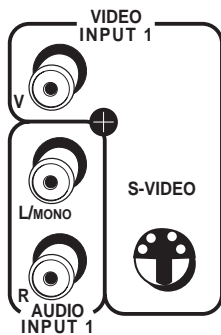

## VIDEO/AUDIO INPUTS

**VIDEO INPUT 1/AUDIO INPUT 1** Lets you connect a baseband NTSC (analog) component.

- V (VIDEO) provides composite video connection and connector is usually yellow.
- L/MONO AUDIO provides left audio connection and connector is usually white.

**Note:** If your component has only one output for audio (mono), connect it to the left (white L/Mono) audio jack on the TV and don't connect the right audio part of the cable.

- R AUDIO provides right audio connection and connector is usually red.
- S-VIDEO lets you connect an S-Video cable for better video quality picture to a component with S-Video capability, such as a VCR or DVD player. When using S-Video, make sure to connect the two audio cables as well as the S-Video connector.

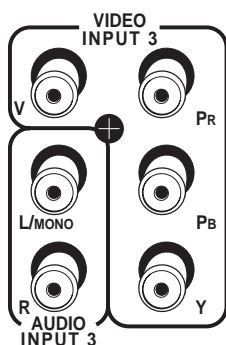

**VIDEO INPUT 2/AUDIO INPUT 2** Provides connection to a second NTSC (analog) video component such as a VCR. The jacks are as described for INPUT 1.

**VIDEO INPUT 3/AUDIO INPUT 3** Used to connect an optional component (Y P<sub>B</sub> P<sub>R</sub>) video source, such as a DVD player or satellite receiver. This connection provides excellent quality. Note that it is essential to match the color coded connectors between a compatible device and the TV.

- AUDIO R/L/MONO The audio jacks provide stereo sound. When connected, audio volume from the main front and rear speakers are variable.
- V (VIDEO) provides composite video connection and connector is usually yellow.
- Y P<sub>B</sub> P<sub>R</sub> Unlike a single video input, component video maintains the video signal as three separate signals through these three jacks. To ensure maximum picture quality, use three video-grade cables for the Y P<sub>B</sub> P<sub>R</sub> connections. Accepts 480i, 480p, 1080i signals. Has priority over V connection.

### Tips

Inputs 3/4 can be used as either a component video (Y P<sub>B</sub> P<sub>R</sub>) input or a composite video (V) input. The TV auto detects the connection with Y P<sub>B</sub> P<sub>R</sub> having highest priority.

480i Y P<sub>B</sub> P<sub>R</sub> is viewable when using PIP but 480p and 1080i are not.

**VIDEO INPUT 4/AUDIO INPUT 4** Provides connection to a second optional component video source, such as a DVD player or satellite receiver. The jacks are the same as described in INPUT 3.

# Connections & Setup

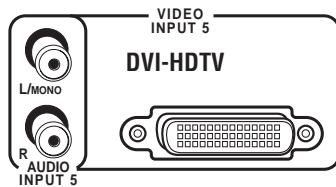

**VIDEO INPUT 5/AUDIO INPUT 5** Provides DVI-HDTV and analog audio connections.

- L/MONO AUDIO provides left audio connection and connector is usually white.
- R AUDIO provides right audio connection and connector is usually red.
- DVI-HDTV provides a digital video connection from a video source to the TV.

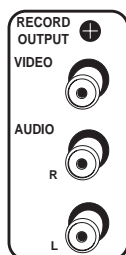

**RECORD OUTPUT** Used to connect to the VCR or DVD-recorder to record digital or analog signals from Antenna A or B and inputs (excluding DVI-HDTV and some component video formats) while TV is turned on.

- VIDEO provides composite video connection and connector is usually yellow.
- AUDIO L provides left audio connection and connector is usually white.
- AUDIO R provides right audio connection and connector is usually red.

**Note:** The record output cannot be used for timed recordings from a device connected to the TV.



**DIGITAL AUDIO OUTPUT** Use a digital optical cable (or SPDIF cable) to connect your TV to a compatible Dolby Digital or PCM receiver or decoder. Dolby Digital offers theatre-quality sound (six audio channels). Use the *Digital Audio Out* screen in the *Audio* menu to select *Auto Select* or *PCM* as the output for this jack.



**G-LINK** Uses to connect the G-LINK cable for VCR one touch recording and/or cable box control with GUIDE Plus+ System.



**ETHERNET** Used to connect a router, cable modem, or Digital Subscribe Line to the TV using an RJ-45 cable (NIC). Do not connect telephone cable because of risk of fire, shock, etc. A green light on the jack means that an active network has been detected. An orange light means the data either is being sent or received.



**DTV LINK** Used to connect a compatible DTVLink (1394) device. With two devices, you can either connect them to each other and then to the TV or connect each to a separate 1394 connector. For several devices, be sure to connect the faster of the 1394 devices in the link closer to the connection point of the TV and the slower devices furthest away. Do not loop the devices.

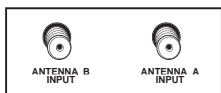

**ANTENNA A INPUT / ANTENNA B INPUTS** Used to connect an off-air “terrestrial” antenna and/or cable TV signal to the TV. If you have both cable and air, connect cable to ANTENNA A and off-air to ANTENNA B. If you have air only, connect it to ANTENNA A.

**Note:** You can use the ANTENNA B (or ANTENNA A) for video games and switch between the two inputs using the ANTENNA button on the remote control. When using TV games, computers, and similar products with your TV, keep the contrast at a low setting. If a fixed (non-moving) pattern is left on the screen for a long period of time at a high contrast setting, the image can be permanently imprinted onto the picture tubes. These types of imprints are not covered by your warranty.

## Why You Should Connect the G-LINK Cable

The G-LINK cable enables the GUIDE Plus+ system (the on-screen interactive program guide) to work with your VCR and/or cable box.

**Cable Box** – If your TV is connected to a cable box, you must connect the G-LINK cable to receive TV program listings for your area and to tune directly to a channel when the program guide is on your TV screen.

**VCR** – If your TV is connected to a VCR and you don't connect the G-LINK cable, one-touch VCR recording won't work. The other features of the guide will work properly, however.

## How to Find the Remote Sensor

You have to place the G-LINK wands in front of the remote sensor on the VCR and/or cable box. Some cable boxes and VCRs have the remote sensor labeled on the unit. If the remote sensor isn't labeled on your VCR and/or cable box, you need to use the remote control that came with the VCR and/or cable box to locate the sensor.

1. Turn off the VCR and/or cable box.
2. Hold the remote control (**not** the one that came with your TV, but the one that came with the cable box and/or VCR to which you're attaching the G-LINK cable) so that it is touching the front of the component.
3. Slowly move the remote control across the front of the component (VCR or cable box) while you press the power button on and off. You must press and release the power button each time you move the remote (holding down the button won't work).

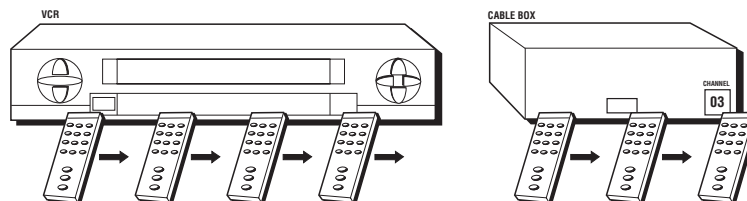

4. When the component turns on, you've located the VCR's or cable box's remote sensor.

## Placing the G-LINK Wands

Place the G-LINK wands in front of the remote sensor on your VCR and/or cable box approximately one inch away from the remote sensor (see instructions below).

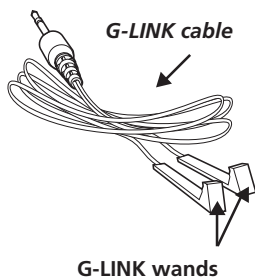
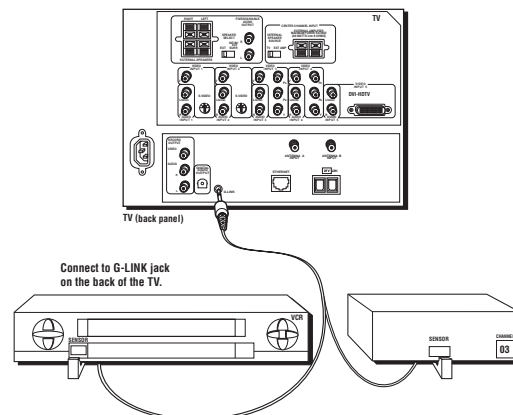

### Tips

If you have both VCR and cable box, it doesn't matter which wand is connected to which box.

If you don't have both a cable box and a VCR connected to your TV, just coil the cable of the extra G-LINK wand with a twist tie and leave it behind the TV.

## The Front of Your TV

### Front Inputs

The TV has front inputs for convenience: an S-VIDEO input, one set of composite AUDIO/VIDEO Inputs, and a headphone jack. Look for a hinged door and open the cover. Please note the illustration below shows a typical front layout and may not resemble your TV.

**Notes:** When you plug in headphones, the TV's internal and external speakers, Fixed/Variable Audio Output, and Digital Audio Output are automatically turned off.

When connecting a device that uses a monaural cable, such as some camcorders, use the Left (mono) input jack to get sound from both speakers.

### Front Panel

If you cannot locate your remote, you can use the front panel of your TV to operate many of the TV's features. As this user's guide covers several models, your TV may or may not have all of the buttons described below.

**MENU/OK** Brings up the Main menu. When the menu system is displayed, pressing MENU/OK selects highlighted items.

**CH▲** Scans down through the current channel list. In the menu system, it points down to items and adjusts menu controls.

**CH▼** Scans up through the channel list. In the menu system, it points up to items and adjusts menu controls.

**VOL◀** Decreases the volume. In the menu system, it points left to items and adjusts menu controls.

**VOL▶** Increases the volume. In the menu system, it points right to items and adjusts menu controls.

**POWER** Turns the TV on and off. The indicator in the button lights when TV is on

**INPUT (only available on 65" model)** Toggles through the TV's available input sources (Front Input, INPUT 1, INPUT 2, INPUT 3, INPUT 4, INPUT 5, DTVLink, the last active antenna (Antenna A or Antenna B).

**INFO (only available on 65" model)** Brings up channel banner with channel and viewing information. Press again to remove the banner. In the GUIDE Plus+ system, brings up more program or promotion information.

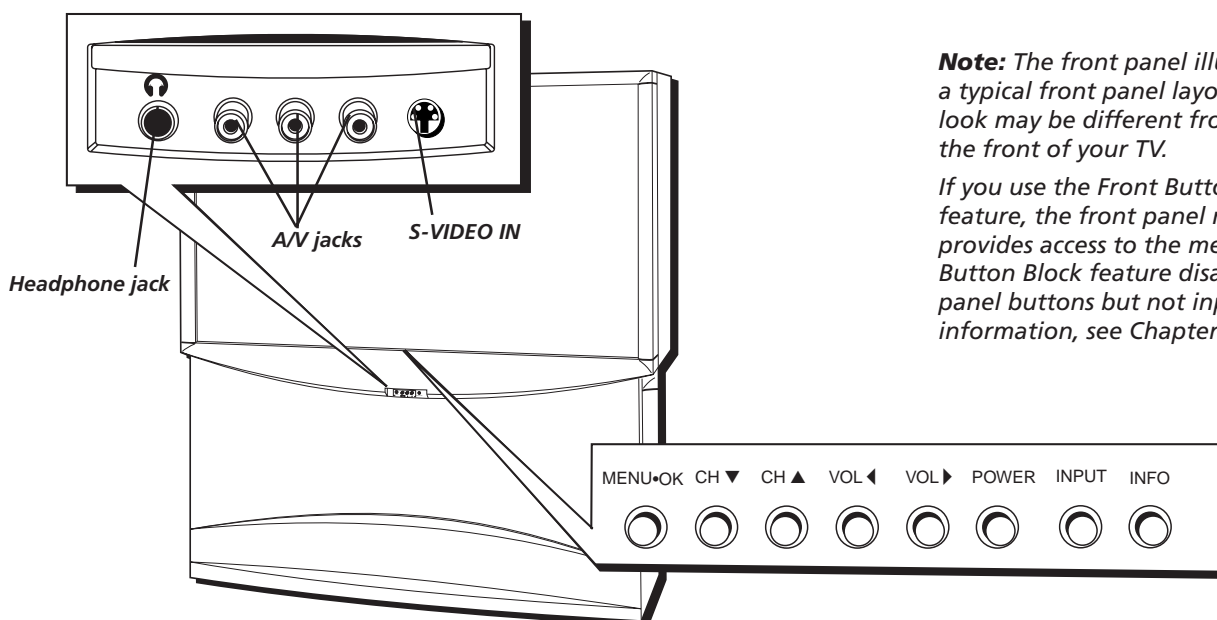

## Plug in the TV

Plug the flat end of the cable into the power jack on the back of the TV. Then plug the end of the power cord into an appropriate wall outlet. Be sure to insert the plug completely. Do not plug into an outlet controlled by a light switch. The TV needs some power to acquire guide listings, do recordings, etc.

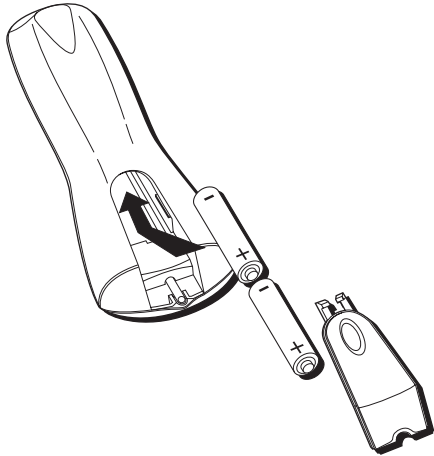

**Note:** When you first plug your TV into an outlet, the Power LED indicator on the front panel will light for approximately 15 seconds and then go off during the initialization of the TV. The TV can only be turned on after the Power LED indicator goes off. This happens every time power is reapplied to the TV.

## Put batteries in the remote

- Remove the battery compartment cover from the back of the remote by pushing down on and sliding off the cover.
- Insert 2 “AA” fresh batteries. Make sure the polarities (+ and -) are aligned correctly.
- Replace the cover.

## Use the Remote Control to Complete the Assisted Setup

The technical term is “Navigation” – how you move through the on-screen menus. The method is the same throughout the menu screens: highlight your choice and select it.

To highlight a menu item, put the remote into TV mode by pressing the TV button then MENU. Press the arrow buttons on the remote to highlight one of the items listed in the menu. Use the up or down arrow button to move up or down. Use the right or left arrow button to move right or left.

To select the item that you’ve highlighted, press OK.

**Note:** Highlighted means that the menu item stands out from other menu items on the list (appears darker, brighter, or a different color).

## Turn on the TV

Press TV on the remote, or press POWER on the TV’s front panel.

**Note:** Pressing the TV button turns on the TV and puts the remote into TV mode. “TV mode” means that the buttons on the remote control operate the TV’s functions.

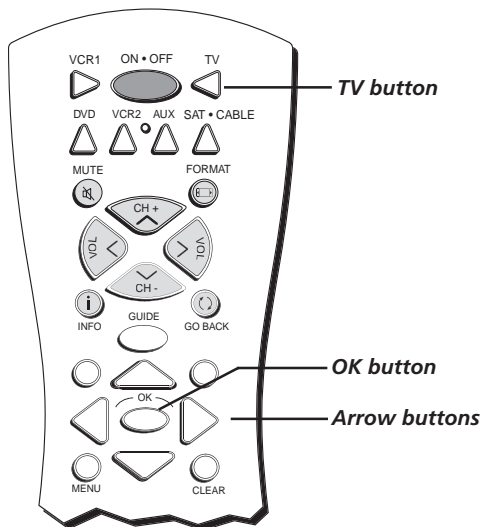

## Tip

To access the setup menus manually, press **MENU** and choose **Assisted Setup**.

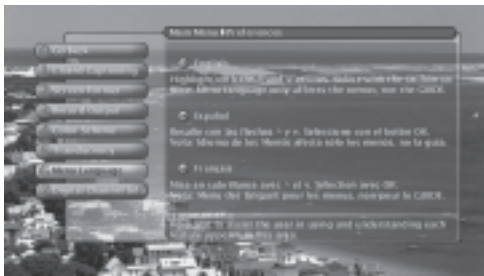

## Complete the Assisted Setup

The menu system in your TV allows the TV's features to be configured to work properly. On-screen information helps you make the right selections for your setup. The first time you turn on your TV, the *Assisted Setup* screens appear automatically.

### Set the Menu Language

The first part of the *Assisted Setup* menu asks you to select your preferred language for the menu system.

1. Highlight your preferred language for the menu system using the arrow buttons.
2. Press **OK** to select that language.

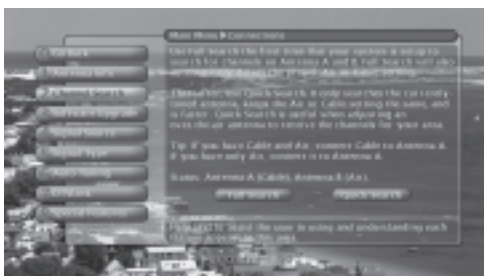

## Tip

Channel Search takes several minutes because the TV is searching for all possible analog and digital channels. You may want to leave and come back later.

### Complete Channel Search

The next part of the *Assisted Setup* asks you if you want the TV to search for all channels viewable through your antenna or cable TV system.

1. Highlight *Full Search* and press **OK** to tell the TV to begin searching for channels. A progress report appears on the screen.
2. When search is complete, press **OK** (the first **GUIDE Plus+** system setup screen appears).

**Notes:** If you skip Channel Search now, you can access it later through the *Connections* menu. See Chapter 4 for more details.

If cable box is connected to **ANTENNA A**, Channel Search cannot work.

### The GUIDE Plus+ System Setup

**Important Note:** If you have a VCR and/or cable box connected to the TV, you need to connect the **G-LINK** cable to use the **GUIDE Plus+** system. If you didn't connect the **G-LINK** cable, go to page 17. Disregard the screen that tells you to refer to the *Quick Setup* sheet because there is no sheet packed with this TV.

The **GUIDE Plus+** system is a no-fee, on-screen interactive program guide that lists what shows are on TV in your area. In order to receive program listings, you need to complete the following steps.

#### Step 1: Identifying Your TV's Location

1. If your country is highlighted, press **OK** on the remote control.

If your country isn't highlighted, press the up or down arrow button on the remote control to highlight your country and press **OK**.



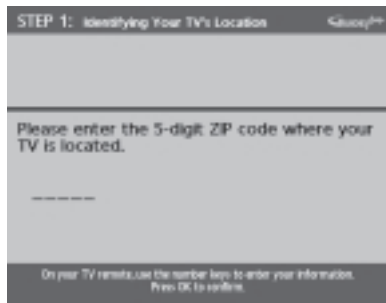

2. Use the number buttons and/or the arrows on your remote to enter your zip code or postal code. Press OK when you're finished.

**Note:** If your postal code contains letters, press the up and down arrow buttons on your remote to enter letters, and press the right arrow button to go to the next space. The left arrow button also moves the highlight to the left.

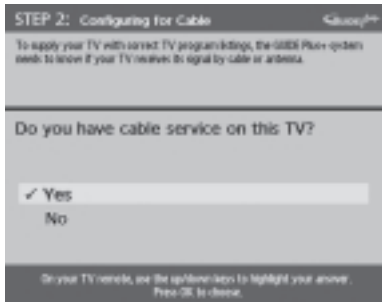

## Step 2: Configuring for Cable

The next series of screens asks you about your cable setup. To supply your TV with the correct TV program listings, the GUIDE Plus+ system needs to know if your TV is connected to a cable TV connection.

**Notes:** If you have two off-air antennas connected (one to ANTENNA A and one to ANTENNA B) and you aren't getting the guide listings, try swapping the antennas.

If your cable system retransmits digital off-air channels over cable, you should select YES to cable inquiry.

You cannot tune to digital channels from the GUIDE Plus+ system if you have cable service or a cable box connected unless an off-air antenna is connected to Antenna B.

1. If your TV is connected to cable, highlight *Yes* and press OK.

If your TV isn't connected to cable, highlight *No* and press OK. (*STEP 3: Configuring for a VCR* appears--go to page 22.)

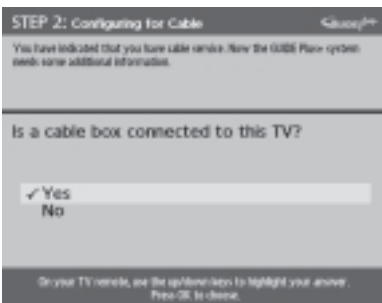

2. If you have a cable box connected to this TV, highlight *Yes* and press OK

**Note:** The next series of screens is very important because the GUIDE Plus+ system must find the correct cable box information in order to receive the correct TV program listings.

If you don't have a cable box connected to this TV, highlight *No* and press OK (*STEP 3: Configuring for a VCR* appears--go to page 22).

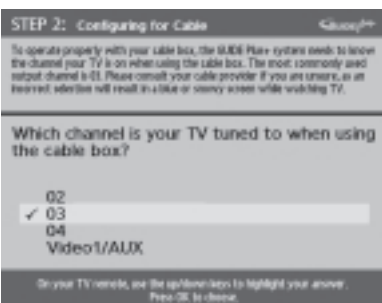

3. Highlight the channel on ANTENNA A where you have to tune your TV to see cable box programming, and press OK (a screen appears reminding you to connect your G-LINK cable to your TV and cable box).

**Notes:** If not using INPUT 1 (VIDEO1/AUX), you must connect to ANTENNA A not B.

Channel 03 is the most common.

Choose Video1/AUX if your cable box is connected to your TV with audio/video cables instead of a coaxial cable. Go to page 7 for pictures of these cables. If you choose Video 1/Aux, then connect the cable box to the TV's INPUT 1.

# Connections & Setup

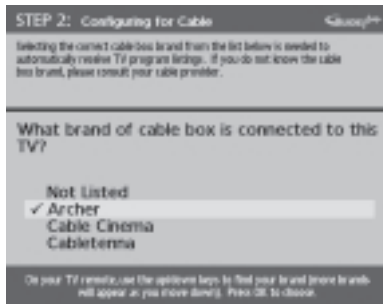

4. Highlight your brand of cable box, and press OK.

If your brand isn't listed, highlight *Not Listed* and press OK.

**Important Note:** Cable box may only be connected to ANTENNA A or INPUT 1 if it is to be controlled by GUIDE Plus+ System

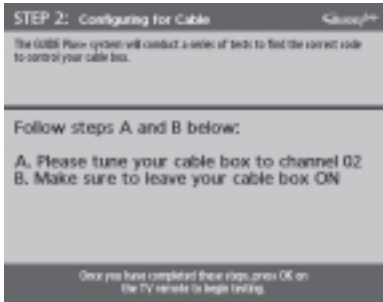

5. Make sure your cable box is on.

Tune the cable box to channel 02 (use the remote control that came with your cable box, or press the channel buttons on the cable box).

Press OK (the GUIDE Plus+ system starts testing codes).

**Important Note:** When code testing is in progress, don't touch your TV, VCR, cable box or any of the remote controls for these products.

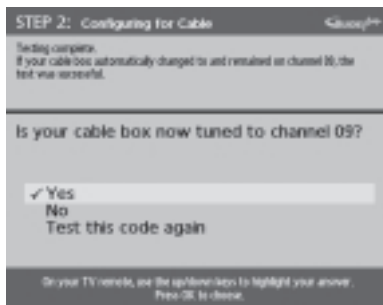

6. Look at your cable box. If it is still on and changed to channel 09, the test was successful. Highlight *Yes*, and press OK (*STEP 3: Configuring for a VCR appears*).

If your cable box didn't change to channel 09 or turned itself off, you have two choices: *No* and *Test this code again*.

*Test this code again:* If you think the TV, the cable box, or any of the remote controls might have been touched or bumped during the test, highlight *Test this code again* and press OK (the GUIDE Plus+ system runs the same set of codes).

*No:* If you don't think the test was interrupted, highlight *No* and press OK (GUIDE Plus+ system tests the next code).

Repeat the previous instructions until the TV finds the correct cable box code. Follow the instructions on the screen.

**Note:** If the TV can't find your cable box code, a troubleshooting checklist appears. Carefully review each checklist and follow the instructions on the screen.

## Step 3: Configuring for a VCR

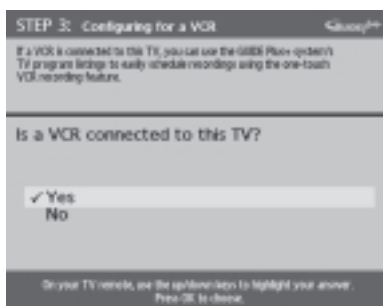

1. If your TV is connected to a VCR, press OK (a screen appears reminding you to connect your G-LINK cable to your TV and VCR).

If it is not, highlight *No* and press OK.



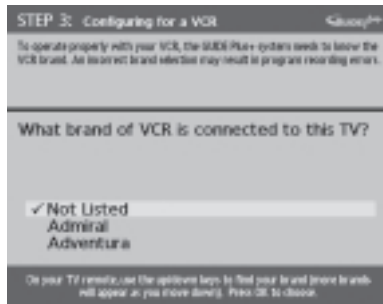

2. Use the up and down arrow buttons to highlight the brand of your VCR that is connected to the TV and press OK.

If your brand isn't listed, highlight *Not Listed* and press OK.

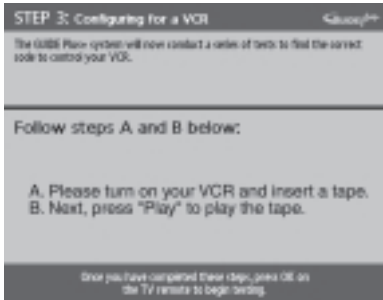

3. Keep the VCR on. When you complete these steps, press OK to begin testing.

**Important Note:** *When code testing is in progress, don't touch your TV, VCR, or any of the remote controls for these products.*

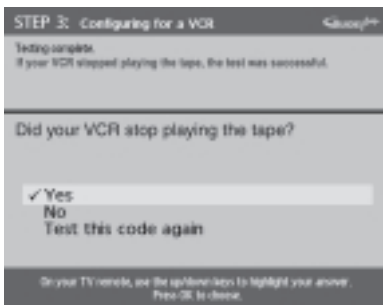

4. Look at the front of your VCR. If your VCR stopped playing the tape, the test was successful. Highlight *Yes* and press OK.

If your VCR didn't stop playing a tape, you can either choose *No* or *Test this code again*.

If you think your TV or remote might have been touched during the test, make sure the VCR is on and playing a tape. Highlight *Test this code again*.

If you don't think the test was interrupted, highlight *No*. Make sure the VCR is playing a tape and is on. Press OK (the GUIDE Plus+ system starts testing another set of codes.)

Keep following the previous instructions until the TV finds the correct code for the VCR.

**Note:** *If the GUIDE Plus+ system can't locate the correct code for the VCR, a list of troubleshooting instructions appears to help you before you try again.*

- *Try VCR configuration again: repeat VCR setup.*
- *Test alternate codes: tests selected brands and if this fails, the test continues with all codes in the system.*
- *Skip this step: the GUIDE Plus+ system won't be able to automatically schedule programs to record on your VCR.*

## Tip

Leave your cable box turned ON to download program information.

Leave your VCR turned OFF to record programs.

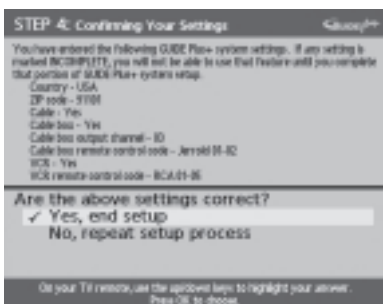

## Step 4: Confirming Your Settings

1. Check to make sure all settings are complete and correct. If all settings are complete, highlight *Yes, end setup* and press OK. If your cable box and/or VCR code testing failed, you should see *INCOMPLETE* where the cable box and VCR codes are listed. Once setup is complete, additional screens appear.

Disregard the screen that tells you to refer to the Quick Setup sheet because there is no sheet packed with this TV.

# Connections & Setup

---

If any settings are incomplete or incorrect, highlight *No, repeat setup process* and press OK. Follow the instructions on the screen.

## What to Expect

The next time you turn on your TV, the GUIDE Plus+ system will appear on the screen. The following examples explain what you might see:

- If all of the program information has been sent to your TV, the GUIDE Plus+ system appears with all of your TV program listings.
- If the program information hasn't been sent to your TV yet, an outline of the GUIDE (without TV program listings) will appear on the screen. Program information is usually sent to your TV at night.
- If more than one cable company services your area, you may be prompted with a Channel Mapping screen after the first GUIDE Plus+ system download. You will need to identify your cable company by selecting the correct channel numbers for the stations in question.

Features of the GUIDE Plus+ system are explained in Chapter 3.

To clear the guide from your screen, press CLEAR or GUIDE on the remote control.

## Next Steps

Now that you've finished the *Assisted Setup*, you're ready to watch TV. This might be a good time to program your remote control. The remote control that came with this TV can be programmed to operate other components. Go to the next chapter to find out how to program your remote.

# Using the Remote Control

## Overview:

- The Buttons on the Remote Control
- Programming the Remote to Operate Other Components
- How To Use the Remote After You've Programmed It
- Code List

SCENIUM

# Using the Remote Control

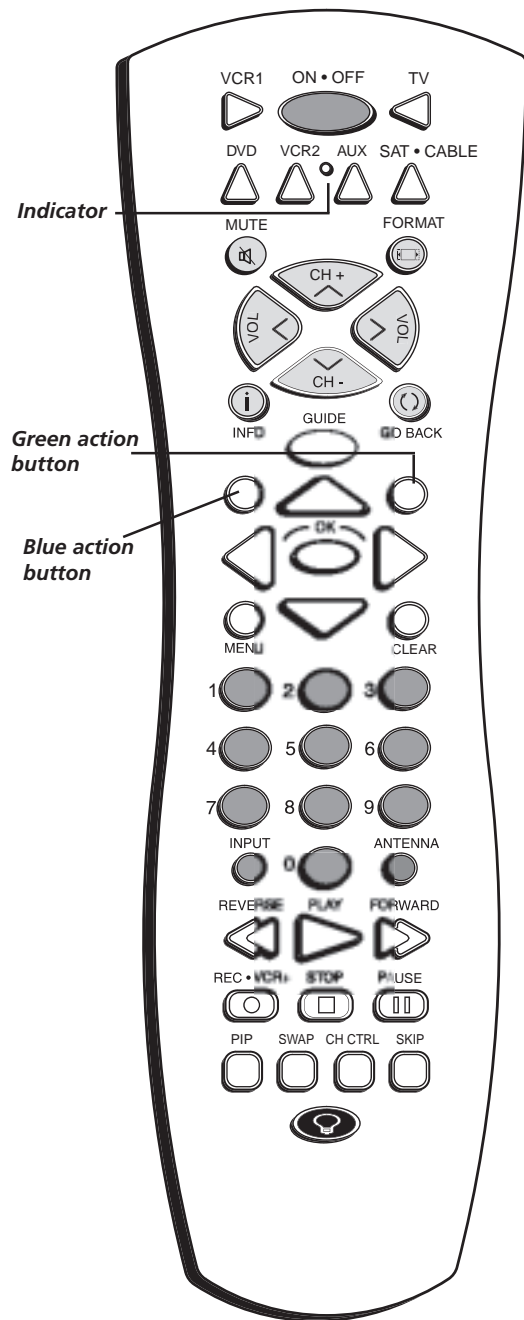

## Tip

The VCR1, DVD, VCR2, and SAT • CABLE buttons also turn on most RCA, GE, and Proscan products.

## The Buttons on the Remote Control

**Blue action Button** In the GUIDE Plus+ system, it activates features (located in the Action bar on TV screen).

**Green action Button** In the GUIDE Plus+ system, it activates the features (located in the Action bar on TV screen).

**(Backlight button)** Press to illuminate some of the remote control's buttons. To conserve battery power, the light turns off after several seconds. Backlight won't activate if batteries are low, but blinks on and off quickly.

**(0-9) Number Buttons** Enter channel numbers and time settings directly through the remote control. Also used in the GUIDE Plus+ system and in the TV menu to make selections.

**ANTENNA** Switches the source of the off-air signal between HDTV's ANTENNA A and B. When in the VCR mode, the ANTENNA button functions as a TV/VCR button. In the satellite mode, it functions as a TV/SAT button. If tuned to an input, ANTENNA takes TV back to last-viewed antenna and channel.

**Arrows (up, down, left, right)** Used to move through the TV menu system, GUIDE Plus+ system, and on-screen displays. Also moves the PIP window when the menu is not on the screen. See page 47 for more information.

**AUX** Places the remote in auxiliary mode to operate a component (such as a cable box, satellite receiver, VCR, DVD, or audio receiver) that you've programmed to work with this button.

**CH + or CH -** Scrolls up or down through the current channel or input list. Press once to change the channel up or down; press and hold to continue changing channels. In the Guide Plus+ system, scrolls a page at a time.

**CH CTRL (Channel control)** Toggles the channel control between the main TV picture and the PIP window. Use channel up, channel down, INPUT, or number buttons to change channels. You can tell which picture changes by looking at the channel banner. CH CTRL is marked by  in the banner.

**CLEAR** Removes any menu or display from the screen and returns you to normal viewing. Used to cancel the commercial skip timer. Used to quit the browser.

**DVD** Places the remote in DVD mode. If Auto Tuning is enabled, pressing the DVD button turns on the TV and tunes to the correct input channel.

**FORMAT** Toggles through screen formats (Normal, Zoom, and Stretch). In browser mode, toggles through three different view sizes: full-size video, video window on the left, and video window on the right.

# Using the Remote Control

---

---

## Tip

To turn off most the RCA, GE, and Proscan components that are connected to the TV, press **ON•OFF** twice within two seconds.

This feature only works with most RCA, GE, and Proscan products.

---

**GO BACK** Returns you to the previous channel or previous screen in the menu system.

**GUIDE** Brings up the *Listings* screen for the Guide Plus+system.

**INDICATOR** Indicates the programming mode when programming the remote to operate components. Lights when a button is pressed and a valid command is sent.

**INFO** Brings up channel banner with channel and viewing information. Press again to remove the banner. In the GUIDE Plus+ system, brings up more program information.

**INPUT** Toggles through the TV's available input sources (Front Input, INPUT 1, INPUT 2, INPUT 3, INPUT 4, INPUT 5, DTVLink (if available), last-active Antenna).

**MENU** Turns the Main menu on or off.

**MUTE** Reduces the TV's volume to its minimum level. Press again to restore volume.

**OK** When a menu is on the screen, press OK to select the item that is highlighted.

**ON•OFF** When in TV mode, turns the TV on or off. If in another mode (VCR, DVD, SAT•CABLE, AUX) and programmed, it turns the component on and off.

**PIP** Makes the PIP window appear and disappear (See Chapter 3 for more information about using PIP.) Locks/unlocks video window in GUIDE Plus+ system.

**REVERSE, PLAY, FORWARD, REC•VCR+, STOP, PAUSE** If programmed, provides transport control for some remote-controllable VCRs, DVD players, and CD players. Press REC•VCR+ outside of the GUIDE Plus+ System to set a manual timer program or enter a PlusCode.

**SAT•CABLE** Places the remote in SAT•CABLE mode. If Auto Tuning is enabled, turns on the TV and tunes to the correct input channel.

**SKIP** Press once before changing channels and the TV returns to the original channel after 30 seconds. Press repeatedly to add more time. Cannot be used with the browser.

**SWAP** When using PIP, switches the main picture with the PIP window.

**TV** Places the remote in TV mode. Turns on the TV and tunes to the last-viewed TV channel or input. Placing the remote in TV mode enables you to access the TV's menu system as well as tune to analog, digital, or cable TV channels.

**VCR1** Places the remote in VCR1 mode. If Auto Tuning is enabled, turns on the TV and tunes to the correct input channel.

**VCR2** Places the remote in VCR2 mode. If Auto Tuning is enabled, turns on the TV and tunes to the correct input channel.

**VOL – or VOL +** Decreases or increases the TV's volume when the TV *Audio Output* option is set to *Variable Speakers On*.

# Using the Remote Control

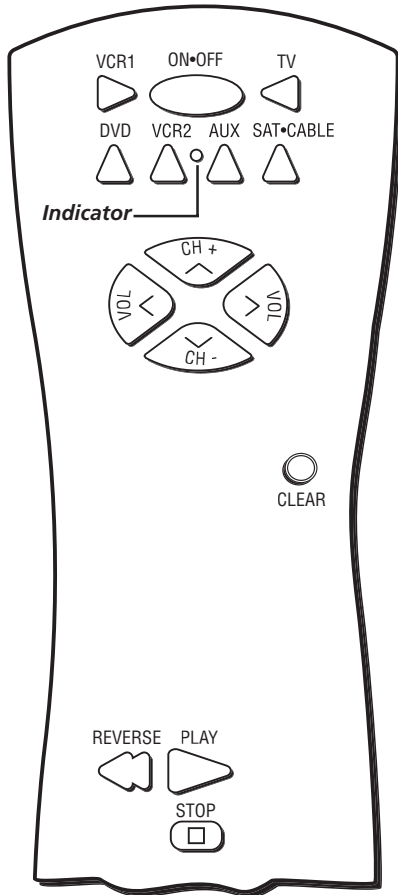

You'll use these buttons when you program the remote.

**Important Note:** The remote may not be compatible with all models of all brands of components. It also may not operate all functions of the remote that came with your component.

## Important for Direct Entry

You must continue pressing the component button while you enter the code.

Let's say you have a Zenith VCR. To program the universal remote to operate the VCR, you would:

Press and hold the VCR1 button while you enter the first code listed for Zenith in the VCR Codes column.

Release the VCR1 button. Press ON•OFF to see if the VCR responds. If it doesn't, follow the same steps, but enter the second code for Zenith VCRs instead of the first.

## Programming the Remote to Operate Other Components

The universal remote can be programmed to operate many brands of remote-controllable VCRs, audio components, DVD players, cable boxes, satellite receivers and other components. In addition to being programmed to operate your television, it's already programmed to operate most RCA, GE, and PROSCAN components.

The AUX button can be programmed to operate most brands of an additional remote-controllable component.

**Note:** The TV button can't be programmed on this remote.

## Find Out If You Need to Program the Remote

To determine whether the universal remote needs to be programmed to operate one of the components connected to your TV, such as a VCR, do the following:

1. Turn on the component (in this example, a VCR).
2. Point the remote at the component.
3. Press the corresponding component button (in this example, VCR1).
4. Press ON•OFF to see if the VCR responds. If the VCR doesn't respond, you need to program the remote to operate it.

## Programming the Remote

There are two ways to program the remote control:

- direct entry
- automatic code search

### Using Direct Entry

**Note:** The AUX button can only be programmed using direct entry.

1. Turn on the component you want to operate (VCR, DVD player, etc.)
  2. Look up the brand and code number(s) for the component on the code list in this section.
  3. Press and hold the component button you want to program on the remote.
  4. Enter the 4-digit code from the remote control code list on the following pages. If the indicator flashes, you have either entered an invalid code or the button isn't programmable.
  5. Release the component button, point remote at component, and then press ON•OFF to see if the component responds to the command. If it doesn't, try pressing the component button and then ON•OFF again.
- If you get no response, repeat these steps using the next code listed for your brand, until the component responds to the remote commands.

# Using the Remote Control

---

- If you try all the codes for your component brand and none work, try the automatic code search method. If automatic code search doesn't find the code, the remote is not compatible with your component.

## Using Automatic Code Search

If Direct Entry does not work for your component, try Auto Code Search. The following instructions can be used to program the remote to operate each of your components. If you want to stop the automatic code search without programming any of your components, press and hold CLEAR until the indicator on the remote turns off.

---

### Tip

*To stop the automatic code search without programming any components, press and hold CLEAR until the indicator on the remote turns off.*

---

1. Turn on the component you want to operate (VCR, DVD player, etc.)
2. Press and hold the component button you want to program (VCR1, DVD, etc.). While holding the component button, press and hold ON•OFF until the indicator on the remote turns on, then release both buttons.
3. Point the remote at the component.
4. Press and release PLAY, then wait 5 seconds or until the indicator on the remote stops flashing.

At this point the remote is searching for the correct code to program. If, after 5 seconds, the component you want to operate does not turn off, press PLAY again to tell the remote to search the next set of codes.

Continue pressing PLAY until the component turns off or you have searched through all of the codes. There are more than 20 total sets of codes. If the component does not turn off after pressing PLAY more than 20 times, then the remote can't be programmed to operate that component.

If the component you want to control *does* turn off:

1. Press and release REVERSE, then wait 2 seconds. Repeat this step until the device turns back ON.
2. To finish, press and hold STOP until the indicator on the remote turns off.

## How to Use the Remote After You've Programmed It

Because this universal remote can control several different components (TV, DVD, VCR, satellite receiver, etc.), it uses operational modes triggered by the component buttons.

1. Press the appropriate component button (DVD, TV, VCR1, VCR2, SAT•CABLE, AUX) to set the remote to control the component.
2. Press ON•OFF to turn the component ON or OFF.
3. Use the remote buttons that apply to that component.

**Notes:** *The remote control may not be compatible with all brands and models of components.*

*If you keep pressing buttons and nothing happens, the remote is probably in the wrong mode. You must press the component button that matches the component you want to operate (i.e., if you want to operate the VCR, press VCR1, VCR2, or AUX on the remote control to put the remote in VCR mode.)*

---

### Tip

*Some of the remote's buttons might operate differently for other components, especially when you're using another component's menu system.*

---

# Using the Remote Control

## Using the INPUT Button

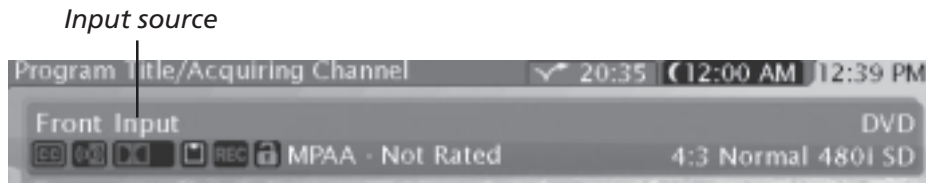

Input source

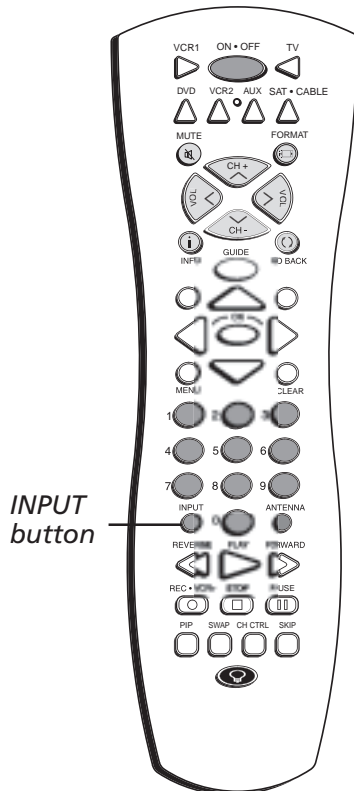

**Note:** Watch the channel banner to see the input sources change each time you press the INPUT button.

1. Repeatedly press the INPUT button to scroll through the available input sources until you find the input associated with the component (such as VCR or DVD player) you want to view.
2. Once you have found the input source you want, stop pressing INPUT.
  - If you tune to INPUT 1 and your DVD is connected to that input, you will be able to view your VCR. To play, stop, or rewind the VCR tape using the remote that came with your TV, you must first press the VCR1, VCR2, or AUX button to put the remote control in VCR mode.

There are other ways of selecting an input channel:

- Program the component (VCR, DVD, etc.) buttons on the remote control to automatically tune to the correct input channel when pressed. For more details on Auto Tuning, see Chapter 3.
- When viewing an input, to go back to viewing channels, press ANTENNA, or press INPUT until you see your channel, or use the number keys to enter the channel number.



# Using the Remote Control

## VCR Codes

Programmable for VCR1, VCR2, and AUX buttons.

Admiral .....	2132
Adventura .....	2026
Aiko .....	2027
Aiwa .....	2026
Akai .....	2003, 2004, 2005, 2007, 2008, 2111, 2112, 2113
American High .....	2021
Asha .....	2013
Audio Dynamics .....	2009, 2010
Audiovox .....	2014
Bell & Howell .....	2011
Beaumarck .....	2013
Broksonic .....	2012, 2025
Calix .....	2014
Candle .....	2013, 2014, 2015, 2016, 2017, 2018, 2019
Canon .....	2021, 2022, 2114
Capehart .....	2020, 2110
Carver .....	2062
CCE .....	2027, 2061
Citizen .....	2013, 2014, 2015, 2016, 2017, 2018, 2019, 2027
Colortyme .....	2009
Colt .....	2061
Craig .....	2013, 2014, 2023, 2061
Curtis-Mathes .....	2000, 2009, 2013, 2016, 2018, 2021, 2022, 2024, 2115, 2131
Cybermex .....	2013
Daewoo .....	2015, 2017, 2019, 2025, 2026, 2027, 2028, 2110
Daytron .....	2110
DBX .....	2009, 2010
Dimensia .....	2000, 2131
Dynatech .....	2026
Electrohome .....	2014, 2029
Electroponic .....	2014
Emerson .....	2012, 2014, 2015, 2021, 2024, 2025, 2026, 2029, 2030, 2031, 2032, 2033, 2034, 2035, 2036, 2037, 2038, 2039, 2040, 2041, 2042, 2044, 2045, 2046, 2047, 2065, 2113, 2116, 2117, 2130
Fisher .....	2011, 2023, 2048, 2049, 2050, 2051, 2052, 2118
Fuji .....	2021, 2119
Funai .....	2026
Garrard .....	2026
GE .....	2000, 2001, 2013, 2021, 2022, 2053, 2115, 2120, 2131
Goldstar .....	2009, 2014, 2018, 2054, 2131
Gradiente .....	2026
Harley Davidson .....	2026
Harman Kardon .....	2009
Harwood .....	2061
Headquarter .....	2011
Hitachi .....	2055, 2056, 2057, 2107, 2111, 2120, 2122
Hi-Q .....	2023
Instant Replay .....	2021
JCL .....	2021
JC Penney .....	2009, 2010, 2011, 2013, 2014, 2021, 2022, 2055, 2056, 2058, 2059, 2060, 2107, 2118
Jensen .....	2055, 2056, 2111
JVC .....	2009, 2010, 2011, 2018, 2111, 2123
Kenwood .....	2009, 2010, 2011, 2016, 2018, 2111, 2123
KLH .....	2061
Kodak .....	2014, 2021
Lloyd .....	2026
Logik .....	2061
LXI .....	2014

Magnavox .....	2021, 2022, 2062, 2063, 2104, 2105, 2108, 2124
Magnin .....	2013
Marantz .....	2009, 2010, 2011, 2016, 2018, 2021, 2062, 2064
Marta .....	2014
Masushita .....	2021
Mei .....	2021
Memorex .....	2011, 2013, 2014, 2021, 2023, 2026, 2104, 2132
MGA .....	2029, 2065, 2113
MGN Technology .....	2013
Midland .....	2053
Minolta .....	2055, 2056, 2107
Mitsubishi .....	2029, 2055, 2056, 2065, 2066, 2067, 2068, 2068, 2070, 2071, 2072, 2073, 2074, 2106, 2113, 2123
Montgomery Ward .....	2075, 2132
Motorola .....	2021, 2132
MTC .....	2013, 2126
Multitech .....	2013, 2016, 2026, 2053, 2061
NEC .....	2009, 2010, 2011, 2016, 2018, 2064, 2076, 2078, 2079, 2111, 2123
Nikko .....	2014
Noblex .....	2013
Olympus .....	2021
Optimus .....	2014, 2132
Optonica .....	2096
Panasonic .....	2021, 2022, 2109, 2125, 2126, 2127
Pentax .....	2016, 2055, 2056, 2107, 2120
Pentax Research .....	2018
Philco .....	2021, 2022, 2062, 2063
Philips .....	2021, 2062, 2096, 2124
Pilot .....	2014
Pioneer .....	2010, 2055, 2080, 2081, 2123
Portland .....	2016, 2017, 2019, 2110
PROSCAN .....	2000, 2001, 2131
Protec .....	2061
Pulsar .....	2104
Quarter .....	2011
Quartz .....	2011
Quasar .....	2021, 2022, 2125
RCA .....	2000, 2001, 2003, 2013, 2021, 2055, 2056, 2082, 2083, 2084, 2085, 2086, 2087, 2088, 2089, 2090, 2091, 2107, 2115, 2120, 2125, 2131, 2133
Radioshack/Realistic .....	2011, 2013, 2014, 2021, 2022, 2023, 2026, 2029, 2049, 2050, 2096, 2132
Radix .....	2014
Randex .....	2014
Ricoh .....	2128
Runco .....	2104
Samsung .....	2005, 2013, 2015, 2033, 2053, 2112
Sanky .....	2104, 2132
Sansui .....	2010, 2092, 2111, 2123
Sanyo .....	2011, 2013, 2023
Scott .....	2012, 2015, 2025, 2032 2038, 2065, 2093, 2116
Sears .....	2011, 2014, 2021, 2023, 2048, 2049, 2050, 2051, 2055, 2056, 2107, 2118
Sharp .....	2017, 2029, 2094, 2095, 2096, 2097, 2131
Shintom .....	2004, 2056, 2061, 2098
Shogun .....	2013
Signature .....	2131
Singer .....	2021, 2061, 2128
Sony .....	2004, 2098, 2099, 2119
STS .....	2021, 2107
Sylvania .....	2021, 2022, 2026, 2062, 2063, 2065, 2124
Symphonic .....	2026
Tandy .....	2011
Tashiko .....	2014
Tatung .....	2111
TEAC .....	2026, 2085, 2111
Technics .....	2021, 2109
Teknika .....	2014, 2021, 2026, 2100, 2129
TMK .....	2013, 2024, 2047

Toshiba .....	2015, 2049, 2051, 2055, 2065, 2093, 2116
Totevision .....	2013, 2014
Unitech .....	2013
Vector Research .....	2009, 2010, 2015, 2016
Victor .....	2010
Video Concepts .....	2009, 2010, 2015, 2016, 2113
Videosonic .....	2013
Wards .....	2013, 2014, 2015, 2021, 2023, 2026, 2029, 2055, 2056, 2061, 2096, 2101, 2102, 2103, 2107, 2116, 2132
XR-1000 .....	2021, 2026, 2061
Yamaha .....	2009, 2010, 2011, 2018, 2111
Zenith .....	2004, 2098, 2104, 2119, 2128

## Cable Box Codes

Programmable for SAT•CABLE and AUX buttons.

ABC .....	5002, 5003, 5004, 5005, 5006, 5053
Antronix .....	5008, 5009
Archer .....	5008, 5009, 5010
Cabletenna .....	5008
Cableview .....	5008
Colour Voice .....	5012, 5013
Comtronics .....	5014
Contec .....	5016
Eastern .....	5017
Garrard .....	5011
GC Electronics .....	5009
GE .....	5000, 5001
Gemini .....	5018, 5019
General Instrument .....	5003
Hamlin .....	5020, 5021, 5022, 5028, 5035, 5045
Hitachi .....	5003
Jerrold .....	5003, 5018, 5023, 5024, 5046, 5053
Magnavox .....	5025
Memorex .....	5026
Movie Time .....	5027
NEC .....	5005
NSC .....	5027
Oak .....	5016, 5029
Panasonic .....	5048, 5052
Philips .....	5011, 5012, 5013, 5015, 5019, 5025, 5030, 5031, 5032
Pioneer .....	5033, 5034
PROSCAN .....	5000, 5001
RCA .....	5007, 5047, 5049, 5052
Realistic .....	5009
Regal .....	5022, 5035
Regency .....	5017
Rembrandt .....	5003
Samsung .....	5034
Scientific Atlanta .....	5006, 5036, 5037, 5038
Signal .....	5018
Signature .....	5003
Sprucer .....	5052
Standard Components .....	5039, 5044
Starcom .....	5018, 5053
Stargate .....	5018
Starquest .....	5018
Tandy .....	5040
Television .....	5014
Tocom .....	5004, 5023
Tusa .....	5018
TV86 .....	5027
Unika .....	5008, 5009
United Cable .....	5053
Universal .....	5008, 5009, 5010
Viewstar .....	5025, 5027
Zenith .....	5050, 5051

# Using the Remote Control

## Satellite Receiver Codes

Programmable for SAT•CABLE and AUX buttons.

Alphastar .....	5079
Chapparral .....	5056, 5057
Dishnet .....	5078
Drake .....	5058, 5059
Echostar .....	5089
GE .....	5000, 5001
General Instruments .....	5060, 5061, 5062
Hitachi .....	5083, 5084
Hughes .....	5077, 5090
JVC .....	5082
Panasonic .....	5075
Philips .....	5085
Primestar .....	5076
PROSCAN .....	5000, 5001
RCA .....	5000, 5001, 5071, 5080, 5081
Realistic .....	5063
Sony .....	5072
STS1 .....	5064
STS2 .....	5065
STS3 .....	5066
STS4 .....	5067
Toshiba .....	5068, 5073
Uniden .....	5069, 5086

## DVD codes

Programmable for DVD and AUX buttons.

Aiwa .....	3009
GE .....	3000
Hitachi .....	3008
JVC .....	3002, 3010
Konka .....	3011, 3012
Magnavox .....	3003
Mitsubishi .....	3004
Panasonic .....	3013
Philips .....	3003, 3019, 3021, 3022
Pioneer .....	3005
PROSCAN .....	3000
RCA .....	3000, 3001
Sanyo .....	3014
Shinco .....	3001
Sony .....	3006, 3015, 3016
Toshiba .....	3007, 3017, 3020
Zenith .....	3018

## Audio Codes

Programmable for the AUX button only.

### RCA and Dimensia

AM/FM .....	4003, 4270
AUX .....	4004
Phono .....	4005
Tape .....	4006
CD .....	4007, 4190, 4211

### Receivers

Aiwa .....	4261, 4262, 4263, 4264, ..... 4265, 4266, 4267, 4277
Denon .....	4283
Harman Kardon .....	4276

JVC .....	4268
JVL .....	4276
Kenwood .....	4269
Onkyo .....	4278
Optimus .....	4284
Panasonic .....	4279, 4280
Pioneer .....	4275
RCA .....	4270
Sherwood .....	4282
Sony .....	4271, 4272, 4281
Technics .....	4279, 4280
Wards .....	4275
Yamaha .....	4274, 4275

### CD Players

ADC .....	4200, 4201, 4220
Aiwa .....	4175, 4203
Akai .....	4205
Denon .....	4208
Dynatech .....	4177
Emerson .....	4178
Fisher .....	4179, 4212, 4213
GE .....	4216
Hitachi .....	4180
JVC .....	4181, 4221
Kenwood .....	4183, 4222, 4224
Luxman .....	4225
Marantz .....	4185, 4226
Mitsubishi .....	4229, 4230
MCS .....	4228
Nakamichi .....	4232, 4233
NEC .....	4184
Onkyo .....	4186, 4234, 4235
Optimus .....	4237, 4238, 4239
Panasonic .....	4188
Pioneer .....	4189, 4240
RCA .....	4190, 4211
Sanyo .....	4250
Sears .....	4207
Sherwood .....	4243
Sony .....	4195, 4209, 4244
Teac .....	4245, 4246, 4247
Technics .....	4197
Toshiba .....	4231
Yamaha .....	4198, 4199, 4268

# Using the TV's Menu System

### Chapter Overview:

- Menus and Control Panels
- Picture Quality Menu
- Audio Menu
- Time Menu
- Connections Menu
- Preferences Menu

SCENIUM

# Using the TV's Menu System

---

## Menus, On-screen Help and Control Panels

This section explores menus of your TV beginning with some information on using menus and control panels. Each menu is outlined and detailed to help you get the most from your TV. The *Guide Plus+ Menu*, *Parental Controls*, and *Web Browser menu* items are discussed in the Features chapter while *Assisted Setup* is discussed in the Connections and Setup chapter.

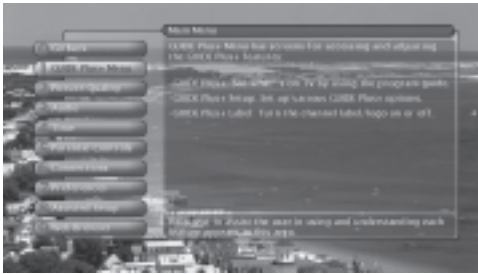

The first menu you see when you press the MENU button on the remote is called the *Main Menu*. To access the *Main Menu*.

1. Press the MENU button (the *Main Menu* appears).
2. Use the arrow buttons (left,right,up,down) to move through the menu items.
3. Press the OK button or right arrow to select a highlighted item in the menu. Or, press the number beside of the menu item to go directly to the menu item. For example, in the Main menu press 3 to go straight to the *Audio* menu.

---

### Tip

Feel free to explore the menu system. If you're ever unsure where you are in the menu system, look at the menu path at the top (for example, *Main Menu ▶ Picture Quality*) or you're just plain tired of exploring, press *CLEAR* to remove the menus from the screen and start over again.

---

## Exiting a menu

There are three ways to exit a menu:

- Highlight *0 (Go Back)* menu button and press OK, or press GO BACK on the remote.
- Press 0 on the remote when you are highlighting the left side of the menu.
- Press CLEAR. The on-screen displays are cleared from the screen and you return to TV viewing.

## On-Screen Help

Information appears on the screen to assist you in understanding your menu selection. To the right of the highlighted menu item is a display area that might provide on-screen help text of the item selected along with any submenu items. In addition, a menu path appears at the top of the screen to let you know where you are in the menu system. And at the bottom of the screen are two lines of text that explain the currently highlighted item.

## Controls

Controls let you adjust the default settings of your TV. You can choose a setting, enter a number, or adjust a level such as tint or brightness. There are four types of controls: sliders, choice lists (check boxes, radio buttons), alpha/numeric entries, and menu (action, choice fields) buttons.

# Using the TV's Menu System



## Sliders

Sliders are used to select a specific point of a control that has continuous levels. To make adjustments:

1. Press the left or right arrow to select the slider control for the feature you want to adjust.
2. Press the up or down arrow to adjust the indicator on the vertical slider.

**Note:** Some sliders are positioned horizontally, for example, *Translucency, Balance, and Initial Volume.*



Check Box List

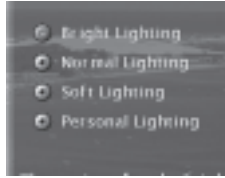

Radio Button List

## Choice Lists

Check boxes and radio buttons are used to select options from among a list of choices. Check boxes let you select one or more options in a choice list. A radio button lets you select only one option in a choice list.

1. Use the arrow buttons to move left/right/up/down.
2. Press OK to select or de-select the option.

## Numeric Entries

Numeric entry fields are used to enter numbers, passwords, and time values. The number buttons on the remote and the arrow, channel up/down, volume up/down, MENU and OK buttons on the front panel can be used to enter the information.

1. Use the left/right button to highlight the field.
2. Use the up/down arrows, number buttons or OK button to enter information.

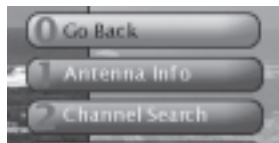
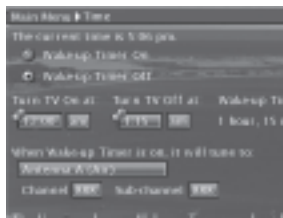

## On-screen Menu Buttons

An on-screen button is used to transfer control from one item to another or perform a specific command. An on-screen button responds to the OK or right arrow button or to the number button on the remote which appears on the on-screen menu button.



## Action Buttons

An on-screen button that performs the action labelled on the button. Press right arrow button to highlight and press OK to select.



## Choice Fields

A choice field cycles through at least two or more choices. Press OK to select the next entry in the choice field.

# Using the TV's Menu System

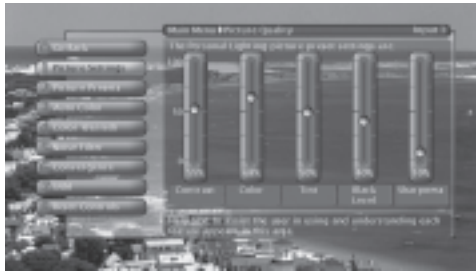

## Picture Quality Menu

The *Picture Quality* menu contains menus to configure video settings: *Picture Settings*, *Picture Presets*, *Auto Color*, *Color Warmth*, *Noise Filter*, *Convergence*, *SVM*, *Reset Controls*.

To access the Picture Quality menu:

1. Press MENU on the remote control (the *Main Menu* appears).
2. Press the down arrow button on the remote control to highlight *Picture Quality*, and then press OK or 2. The following menu options appear, are described in order on the following pages.



## Picture Settings

The *Picture Settings* menu displays five slider controls for adjusting the way the picture looks. The picture settings apply to the video for the main TV picture (including PIP) and the video input selections (Front Input, Input 1, Input 2, Input 3, Input 4, Input 5, DTVLink, analog channels, and digital channels).

Your options under the *Picture Settings* menu are:

- **Contrast** Adjusts differences between the light and dark areas of the picture.
- **Color** Adjusts the richness of the color.
- **Tint** Adjusts the balance between the red and green levels.
- **Black Level** Adjusts the brightness of the picture.
- **Sharpness** Adjusts the crispness of the edges in the picture.

To create picture settings for the video inputs:

1. Press the INPUT button while in the *Picture Settings* menu until the correct the Video Input Channel appears in the upper right corner.
2. Press the right and left arrow buttons on the remote control to select the slider.
3. Press the up and down arrow buttons to operate the slider.

**Note:** When changing an item in the *Picture Quality* menu, the graphics become transparent to allow you to clearly see the video behind the displays.

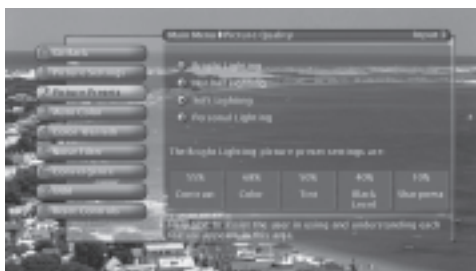

## Picture Presets

*Picture Presets* displays a choice list that lets you select one of the four preset picture settings: *Bright Lighting*, *Normal Lighting*, *Soft Lighting*, *Personal Picture Preset*.

Choose your setting based on the degree of lighting in your room. After you select a setting, the contrast, color, tint, black level and sharpness settings found under the *Picture Settings* menu are adjusted automatically.

If you choose *Personal Picture Preset*, you can customize color, tint, black level, and sharpness to your desired level, and the television saves those settings. After you've done this, you can go back into the menu and select *Bright*, *Normal* or

# Using the TV's Menu System

*Soft Lighting* without losing your personal preset. For example, if you normally use *Personal Picture Preset* but want to watch a show in *Bright Lighting*, you can choose *Bright Lighting*, watch the show, and then afterwards return to your customized settings by choosing *Personal Picture Preset*.



## Auto Color

*Auto Color* minimizes the flesh tone variations of the TV picture. The *Auto Color* setting can be stored for each input. Choose *On* or *Off*, depending on your preference.

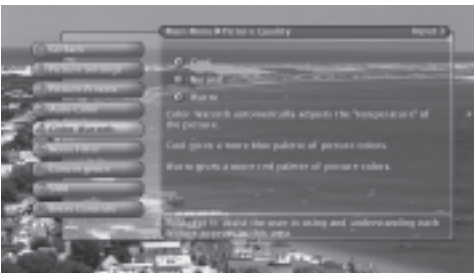

## Color Warmth

*Color Warmth* automatically adjusts the color temperature of the picture. *Color Warmth* can be stored for each input. The feature lets you set one of three automatic color adjustments:

- **Cool** for a more blue palette of picture colors.
- **Normal** for an ordinary picture color.
- **Warm** for a more red palette of picture colors.



## Noise Filter

*Noise Filter* displays a list that lets you set one of the three settings that allows you to reduce picture "static" or any type of interference. A *Noise Filter* setting can be stored for each input. You can set the *Noise Filter* to *Frame Comb*, *Off* or *Adaptive*. The settings are explained in the on-screen help text.

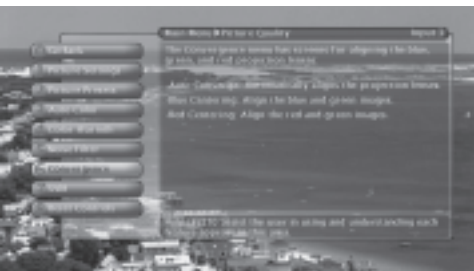

## Convergence

The *Convergence* feature lets you adjust the TV's three tubes. When the TV tubes' images are precisely aligned, they create the color images you see on the screen. Over time, the picture can drift out of alignment (this is normal). If your picture seems fuzzy or has a yellow tint, using *Convergence* could correct this misalignment. When you select the *Convergence* feature a submenu appears with three options:

- **Auto Converge** automatically aligns the projection lenses to self-correct color images. You'll see flashing squares of color dance across the screen (this is normal).
- **Blue Centering** aligns the blue and green images to fine tune picture.
- **Red Centering** aligns the red and green images to fine tune picture.

**Note:** The ability to change channels is disabled when adjusting the convergence options and the TV must be tuned to a usable signal.

# Using the TV's Menu System

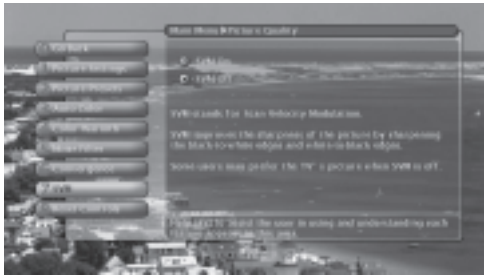

## SVM

SVM stands for Scan Velocity Modulation. This feature improves the sharpness of the picture by changing the speed of the cathode-ray tubes' electron beam when it transitions between dark and light areas of the screen. It sharpens the black-to-white edges and white-to-black edges. Choose *On* or *Off*, depending on your preference.

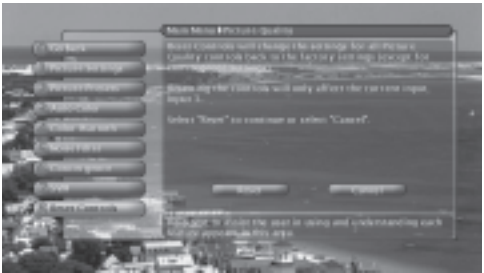

## Reset Controls

The *Reset Controls* menu button resets all picture quality controls to their original factory settings (except for the convergence settings) for the current input.

1. Tune to the "input" for which you would like to apply the setting.
2. Press MENU to access the main menu.
3. Select *Picture Quality*, and then select *Reset Controls* to set reset the settings for the currently tuned input.

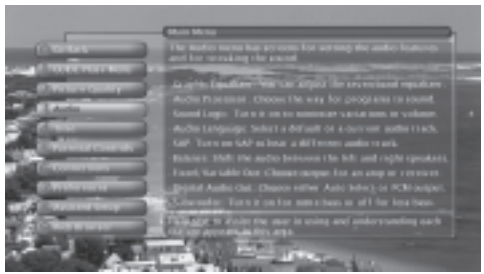

## Audio Menu

The *Audio* menu lets you adjust audio output. To access the *Audio* menu, press MENU on the remote, and then select *Audio* from the main menu. The following audio items can be adjusted: *Graphic Equalizer*, *Audio Processor*, *Sound Logic*, *Audio Language*, *SAP*, *Balance*, *Fixed/Variable Out*, *Digital Audio Out*, *Subwoofer*.

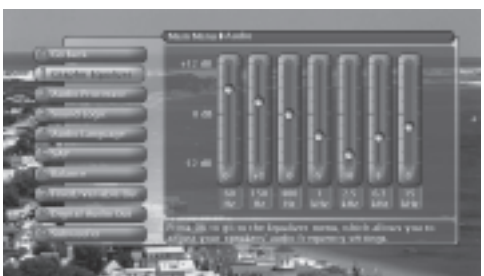

## Graphic Equalizer

The seven-band graphic equalizer lets you adjust the audio frequency settings. The equalizer can only be changed if the *Fixed/Variable Audio Output* is set to *Variable Output*. If the *Fixed/Variable Audio Output* is set to *Fixed Output*, you cannot make changes to the equalizer and the bands are set to 0dB. However, the graphic equalizer levels for *Variable Output* are stored in memory in case you switch to *Fixed Output* then back to *Variable Output*.

**Note:** If the internal speakers are used as the center channel audio speaker from an external audio receiver, the graphic equalizer settings do not apply.



# Using the TV's Menu System

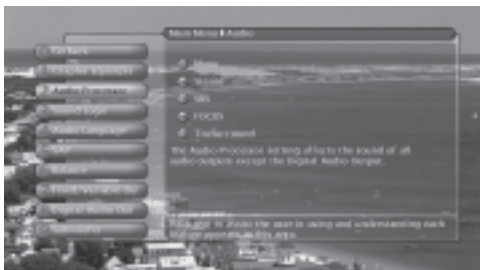

## Audio Processor

The Audio Processor displays a choice list of available audio modes, which control the way the sound comes through your speakers. The selected setting affects all inputs and antennas.

To create the settings:

1. Press the MENU button to access the main menu.
2. Select *Audio*, and then *Audio Processor*. Depending on your speaker setup, any combination of the following options appear:
  - **Mono** plays the sound in monophonic audio only. This should only be used when receiving broadcasts where distance from the broadcasters makes the stereo signal weak. The channel banner displays the word Mono when you tune to a program that is broadcast in mono.
  - **Stereo** Splits the incoming stereo audio signal into left and right front channels. Most TV programs and recorded materials have stereo audio. The channel banner displays the word Stereo when you tune to a program that is broadcast in stereo.
  - **SRS TruSurround** Adds greater depth and stereo separation to stereo audio signals. Delivers a panoramic 3D sound stage from stereo material.
  - **SRS Focus** Redirects the treble portion of the audio in the speaker system to make dialog more understandable. Repositions and elevates the audio to the center of the TV.
  - **SRS TruSurround** Creates a virtual 5.1 surround sound from multichannel source material through any two-speaker playback system.

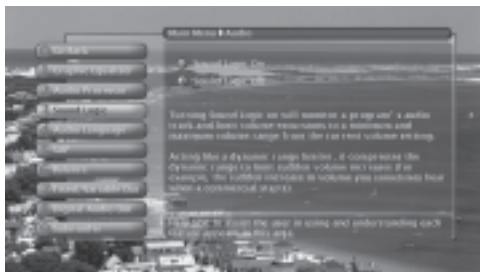

## Sound Logic

Monitors a program's audio track and limits volume excursions to a minimum and maximum volume range from current volume setting. Acting like a dynamic range limiter, it compresses the dynamic range to limit suggested volume increases (for example, the sudden increase in volume you sometimes hear when a commercial starts). Choose *Sound Logic On* or *Sound Logic Off* depending on your preference.



## Audio Language

The *Audio Language* menu lets you choose the default audio language you want to hear for ATSC (digital TV) programs. If the Audio Language icon in the banner lights, it means there is more than one audio language available. The system automatically sets the audio program to the selected audio language when the channel you are viewing is a digital terrestrial channel and the specified language is available for that program.

TruSurround, SRS and (o) symbol is a trademark of SRS Labs, Inc.

TruSurround technology is incorporated under license from SRS Labs, Inc.

# Using the TV's Menu System

In the *Audio Language* menu, highlight the audio language you want by pressing the up and down arrow buttons on your remote control. Press OK to activate.

Some programs can have audio languages available that can be heard, but that cannot be set as the default. To select and hear those audio languages, navigate to the “Change Audio” action button and select OK.

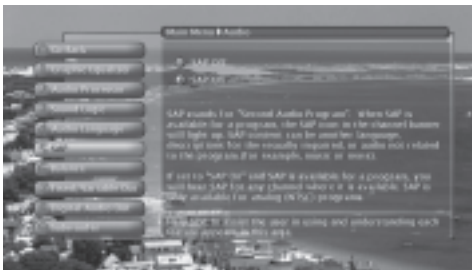

## SAP (Second Audio Program)

When turned on, Second Audio Program plays the program's audio in a second language, if one is available. *SAP* is also used to broadcast a program's audio with descriptions of the video for the visually impaired. Or, *SAP* might contain audio which is totally unrelated to the video.

**Note:** *SAP* is broadcast in mono and is only available for analog programs, not digital programs.



## Balance

The *Balance* setting applies to the internal speakers, rear external speakers and the headphone output. Balance does not affect the internal subwoofer nor any other audio output. Balance is how much audio (loudness) gets sent to the left and right speakers.

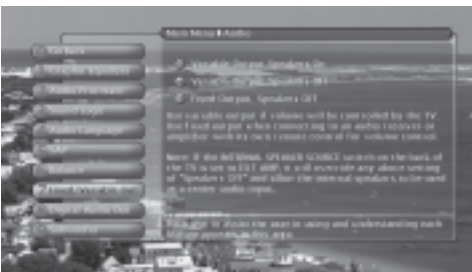

## Fixed/Variable Out

The *Fixed/Variable Out* menu displays a choice list that lets you turn the TV's front internal and external speakers on or off and set the Fixed/Variable audio output to a fixed- or variable-control level. The choices are:

- **Variable Output, Speakers On** This setting turns the TV's front speakers *On* and allows variable output from the TV's Fixed/Variable Audio Output jacks. Use this setting if the TV is not connected to an audio receiver or amplifier and the volume is controlled by the TV.
- **Variable Output, Speakers Off** This setting turns the TV's front speakers *Off* and allows variable output from the TV's Fixed/Variable Audio Output jacks. Use this setting if the TV is connected to an audio receiver or amplifier and the volume is controlled by the TV.
- **Fixed Output, Speakers Off** This setting turns the TV's front speakers *Off* and provides fixed output from the TV's Fixed/Variable Audio Output jack to a receiver or amplifier. With the Fixed Output, the TV's volume control, graphic equalizer, and mute are disabled. This output is ideal when connecting to an audio receiver or amplifier that has its own remote control for controlling the volume.

**Note:** If the *Internal Speaker* source switch on the back of the TV is set to *EXT AMP*, it overrides any above setting of *Speakers Off* and allows the internal speakers to be used as a center speaker input.

# Using the TV's Menu System

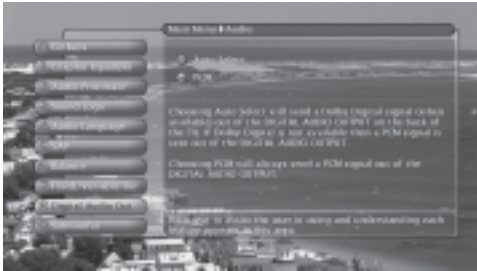

## Digital Audio Out

If you've connected a six-channel amplifier/receiver to the TV's DIGITAL AUDIO OUTPUT jack with a digital optical cable, you can receive Dolby Digital\* surround sound if transmitted. Choose the correct setting in the *Digital Audio Out* menu:

- **Auto Select** If selected, your TV automatically chooses between Dolby Digital and PCM based on the audio signal it is receiving. This is the best selection if you have a Dolby Digital\* and PCM decoder that was manufactured in the last several years.
- **PCM** (Pulse Code Modulation) If selected, the TV sends all signals through the Digital Audio Output in PCM.



## Subwoofer

The built-in Subwoofer enhances low-frequency audio. The Subwoofer setting can only be changed if the Fixed/Variable audio output is set to the Variable Output. The choices are: *Subwoofer On* or *Subwoofer Off*.

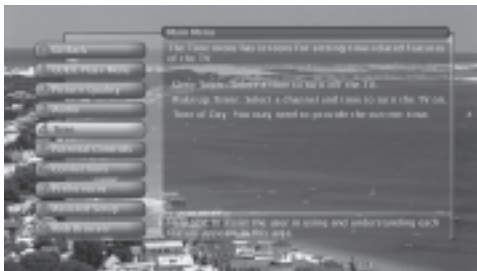

## Time Menu

The *Time* menu lets you set up time-related features such as: *Sleep Timer*, *Wake-up Timer*, or *Time of Day*. Just follow the on-screen help text to assist you in setting up the features—the information is explained in detail.

**Note:** If your TV does not automatically acquire the time, you must remember to set your TV's time when the time changes to Daylight Saving Time. *Sleep Timer* and *Wake-up Timer* will not function as you expect if you forget to change the TV's time.



## Connections Menu

The *Connections* menu specifies various ways to adjust the inputs to your television. Items in the *Connections* menu are: *Antenna Info*, *Channel Search*, *Software Upgrade*, *Signal Source*, *Signal Type*, *Auto Tuning*, *DTVLink*, *Special Features*, *Ethernet Setup*.

## Antenna Info

This screen lists any channel EVER added to the TV. The list shows the channel number, the station name when tuned, e.g. NBC, whether the channel is digital or analog, which antenna is picking up the channel, and for digital channels, and its current signal strength.

\*"Dolby", "Pro Logic", and the double-D symbol are trademarks of Dolby Laboratories.

# Using the TV's Menu System

When you move the highlight to the *Antenna Info* list, the TV attempts to tune to the channel. You can then adjust your off-air antenna for maximum signal strength (largest number) for the selected channel. The signal strength for a digital channel will be shown as “- -” until the signal is strong enough for use, then numbers will appear. Analog channels will always have the display, “N/A”, since analog signal strength is not measured.

Only primary channels appear in the list. Subchannels, e.g. 8-1, 8-2, do not appear.

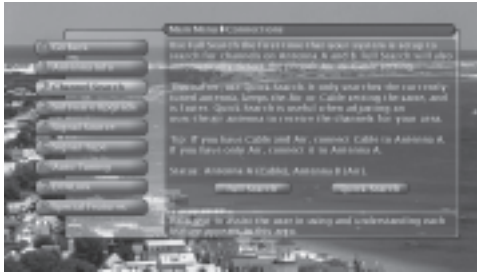

## Channel Search

Engaging in a channel search tells the TV to search for all the terrestrial TV channels available through the antenna inputs. When the TV finds an active channel, it places it in the channel list. Inactive channels (weak stations or channels with no signal at all) aren't placed in the channel list.

The *Channel Search* screen lets you choose a *Full Search* or a *Quick Search*.

**Full Search** Searches both Antenna A and B, automatically detects whether you are using cable or an off-air antenna.

**Note:** A Full Search can take several minutes.

**Quick Search** Searches only for channels on the antenna you're currently using and uses the current *Air* or *Cable* setting. For optimum reception, you need to conduct a *Quick Search* after you've adjusted a terrestrial antenna because the TV might pick up new channels.

**Notes:** Channel Search takes a long time to complete because all possible analog and digital channels are being searched.

If a cable box is connected to Antenna A and GUIDE Plus+ Setup was informed, a channel search will not be permitted.

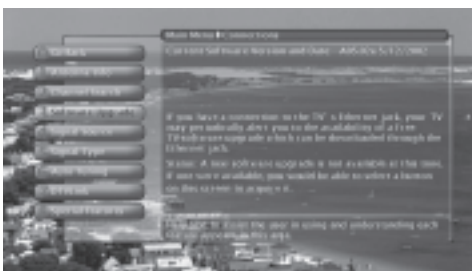

## Software Upgrade

The *Software Upgrade* screen contains current software information and indicates if a new upgrade is available. The software information and upgrades can be accomplished only if you have the TV connected via the Ethernet cable to the Internet.

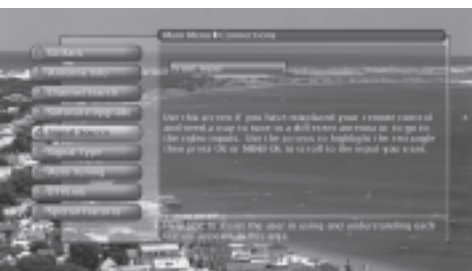

## Signal Source

The *Signal Source* menu allows you to choose the source from which you would like the signal to come: Antenna A, Antenna B, or Video Inputs. The same can be accomplished using the component buttons if you've set up Auto Tuning on the remote or the INPUT button. But, if you misplace the remote, this feature gives you another way to tune to a signal source.

# Using the TV's Menu System

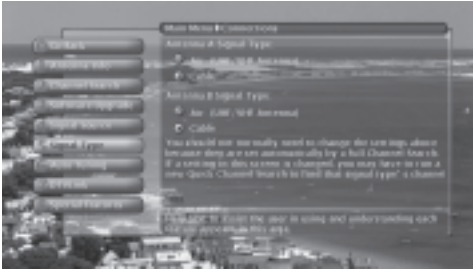

## Signal Type

The *Signal Type* screen lets you choose whether you are receiving a signal from cable TV or an off-air antenna for Ant A or Ant B. When you run *Channel Search*, the TV automatically detects your signal and you don't have to specify it here. However, if you decide to change the source, you can use the *Signal Type* screen. Changing the source on Antenna A may mean that you will have to make changes to your GUIDE Plus+ Setup settings.

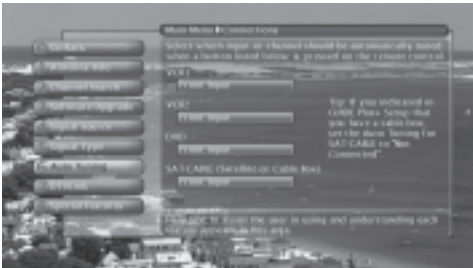

## Auto Tuning

This menu lets you specify the various components you have connected to your TV. It lets you program a component button on the remote control (VCR1, VCR2, DVD, or SAT•CABLE) so that pressing the button automatically turns on the TV and turns the TV to the correct video input channel (see the Features chapter on page 46 for detailed information).

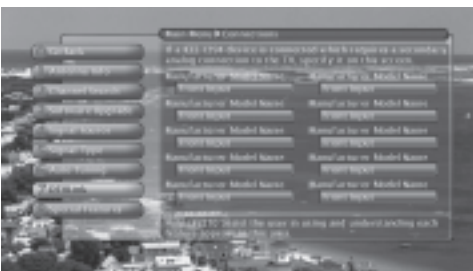

## DTVLink® (Digital Television Link)

Better known to some as IEEE 1394 or FireWire\*, these jacks enable connection of high-speed digital technology to DTVLink devices. With the two jacks, you can network your digital devices by linking them together.

Some DTVLink set top devices need an additional analog video connection to the TV. The screen tells you which device needs this connection. You then select which analog input is used for the connection.

**Notes:** When a device is plugged in or unplugged, the DTVLink screen is updated automatically.

Some IEEE 1394 devices supply power to other devices. This TV does not supply power to other devices.

Some devices that do not support Digital Copy Protection may cause errors on the DTVLink connection if another source that supports Digital Copy Protected material is connected to the DTVLink.



## Special Features

*Initial Channel* and *Initial Volume* are two special features that are for commercial/retail use only.

**Initial Channel** You can select the channel that your TV tunes to each time the TV is turned on or plugged in.

**Initial Volume** This features works only if the *Initial Channel* feature is set to *On*. Select the volume level that you want when the TV is turned on.

# Using the TV's Menu System

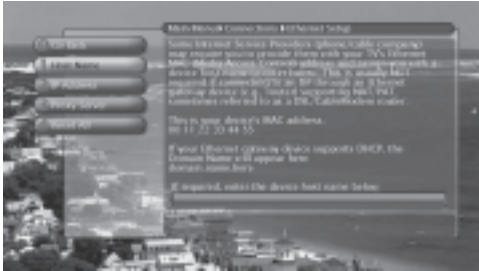

## Ethernet Setup

If you have a NAT/PAT device with DHCP capability, no setup is required. The TV automatically sets itself up for Ethernet use. If you do not have a NAT/PAT router, you may need to establish some settings in conjunction with your ISP (Internet Service Provider) before you can connect to the Internet. Your ISP needs your TV's MAC (Media Access Control) address to give you a host name. This appears on the same screen where you set the host name as required by your ISP. It is unlikely you may need to fill in the IP address and/or Port by your ISP. You may need to enter another IP address for the proxy server to gain access to other hosts on the Internet. This address, if required, will be provided by your ISP.

A *Reset All* selection is provided for your convenience if you move the TV to another city and have to enter new information.

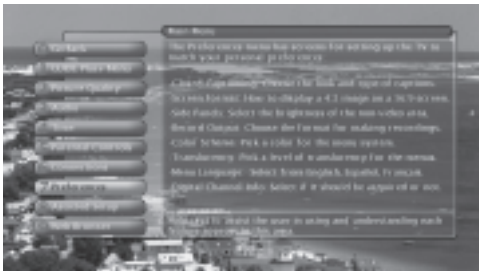

## Preferences Menu

The *Preference* menu allows you to change some aspects of your TV to fit your personal preferences. Features in the *Preference* menu are: *Closed Captioning*, *Screen Format*, *Record Output*, *Color Scheme*, *Translucency*, *Menu Language*, *Digital Channel Info*.

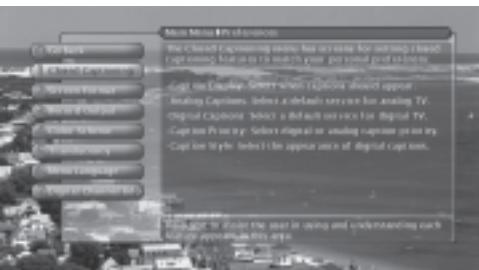

## Closed Captioning

You may set the type of captioning displayed from the main tuner. Captioning is not available from the PIP tuner. Choices within the *Closed Captioning* menu are: *Caption Display*, *Analog Captions*, *Digital Captions*, *Caption Priority*, *Caption Style*.

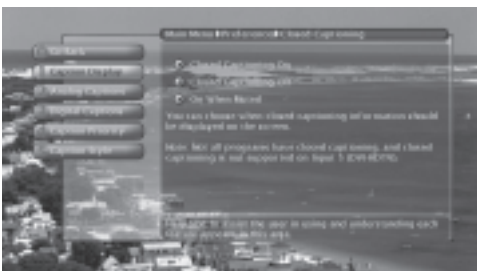

## Caption Display

The Caption Display menu displays a choice list that lets you choose when closed captioning information is shown on the screen. Input 5 (DVI-HDTV) is not supported by Closed Captioning.

**Closed Captioning On** Captioning information is shown always, when available.

**Closed Captioning Off** No captioning information is displayed.

**On When Muted** Captioning information is only shown when the TV's sound is muted, when available. (To mute the sound, press the MUTE button on the remote control and captioning information will appear on the screen.)

# Using the TV's Menu System

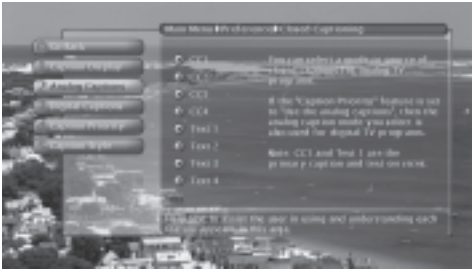

## Analog Captions

You can select a closed caption mode, which is the mode, or source, used for displaying captioning information for all analog channels. The content of CC and Text are different; you can select which one you want to see on the screen.

**CC** CC displays information at any position on the screen. It overlays the text on top of the picture as it is received.

**Text** Text displays information at one particular position (such as the bottom third) of the screen. You cannot see the picture underneath the text.

You can choose between eight closed caption modes, or sources:

- **CC1** and **Text 1** are the primary caption and text services. The captioning or text is displayed in the same language as the program's dialog.
- **CC3** and **Text 3** serve as the preferred data channels. The captioning or text is often a secondary language translation, simplified English, or displayed at a slower rate.
- **CC2** and **CC4** and **Text 2** and **Text 4** are rarely available and broadcasters use them only in special conditions, such as when CC1 and CC3 are not available, or Text1 and Text3 are not available.

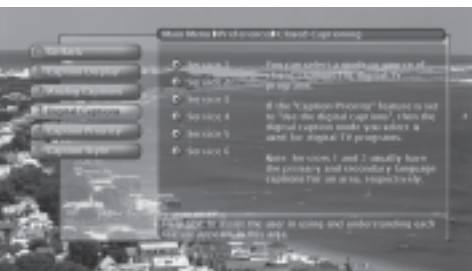

## Digital Captions

You can select a closed caption, service mode (1-6) for digital channels. The service modes support MPEG-2 based transport sources such as DTVLink.

**Service 1** and **Service 2** are the primary and secondary languages, respectively.

**Service 3** and **Service 4, 5, 6** are additional caption sources that may be available. Specific label names may be displayed (e.g., Spanish) instead of a generic label (e.g., Service 1), if available.

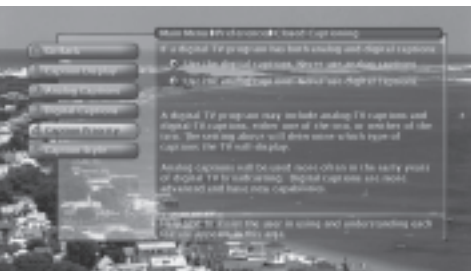

## Caption Priority

You can choose whether the TV uses digital or analog captions for digital TV programs that have both or either.

- If you select *analog* captions and they are available for a digital TV program, the CC icon in the banner lights.
- If you select *digital* captions and they are available for a digital TV program, the CC icon in the banner lights.

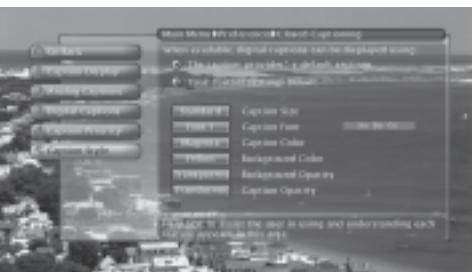

## Caption Style

Customize closed captioning for the digital captions by choosing the settings for the following options:

**Caption Size** is the font size (**Standard**, **Large**, **Small**) of the text characters.

**Caption Font** is a complete assortment of letters, numbers, punctuation marks, etc. of a given font design. You have eight fonts with varying styles of spacing from which to choose.

*Note: A preview graphic of the caption font appears on the right.*

# Using the TV's Menu System

---

**Caption Color** allows you to choose the font color: **White, Black, Red, Green, Blue, Yellow, Magenta, Cyan.**

**Background Color** allows you to choose the background color: **White, Black, Red, Green, Blue, Yellow, Magenta, Cyan.**

**Background Opacity** allows you to change the see-through options: **Solid, Transparent, Translucent, and Flashing.** Solid is the default setting.

**Caption Opacity** allows you to change the see-through options: **Solid, Transparent, Translucent, and Flashing.**

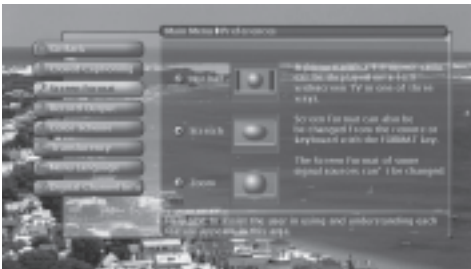

## Screen Format

The *Screen Format* feature allows you to change how the image of a 4:3 picture is displayed on your 16:9 screen. The options are Normal, Zoom or Stretch. If your TV receives an image with a 4:3 aspect ratio, the image can be displayed in one of three ways:

**Normal** The image of a 4:3 video signal is centered with gray bars on the right and left sides of the screen.

**Stretch** The image of a 4:3 video signal is stretched horizontally by approximately 33% while the vertical size stays the same.

**Zoom** The image of a 4:3 video signal increases by approximately 33% and the vertical size increases by approximately 33%.

**Notes:** *There is no need to change the screen format for a 16:9 video signal since it fills up the entire area of the TV's screen.*

*The FORMAT button on the remote gives you access to change the format with a one-button press rather than navigating through the menu system.*

*Normal and Stretch do not affect Record Output; Zoom may alter the original video.*

*Some programs are copy protected and cannot be recorded. If REC icon in banner is dim, a recording cannot be made because of copy protection limits.*

*The format of some video cannot be changed even though it appears to be a 4:3 aspect-ratio picture.*

*Depending on the input and video content, the TV may or may not be able to display the side panels as gray. Therefore, limited viewing of a 4:3 image is recommended when no side panels are present. The same advice applies even if the side panels are present. Use the FORMAT button to view screen formats other than those with sidepanels (Zoom, Stretch). Some video formats may not be able to be changed with the FORMAT button.*



# Using the TV's Menu System

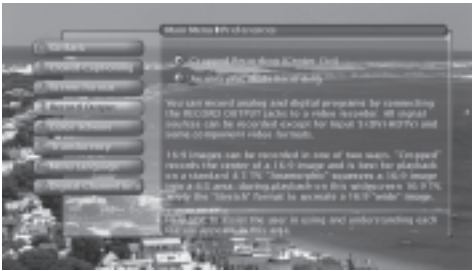

## Record Output

16:9 signals can be recorded in one of two ways: *Cropped Recording (Center Cut)* and *Anamorphic Mode Recording*. *Cropped Recording* records the center of a 16:9 signal and the *Anamorphic Mode Recording* compresses the 16:9 signal into a 4:3 area.

**Notes:** To make the "clearest" recording, avoid using PIP, GUIDE Plus+ system, browser, or zoom screen format. Doing so will have unwanted effects on the recorded video.

The TV does not need to be on to make a recording as long as the recording being made was set up in the GUIDE Plus+ system. When the TV is off, the Record Output may show the TV tuning channels in a date acquisition activity. This is normal.

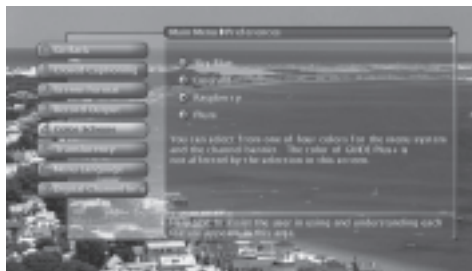

## Color Scheme

Select from among four colors (*Sky Blue, Emerald, Raspberry, Plum*) to change the color of the menu system and banner.

**Note:** The guide and browser colors are unaffected.

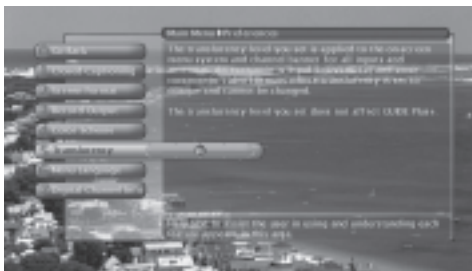

## Translucency

You can change the translucency (see-through) level of the menu screens. Adjust the slider by using the left and right arrow buttons.

**Notes:** This does not apply to GUIDE Plus+ system and browser.

Some video formats do not support the display of translucency on-screen displays.

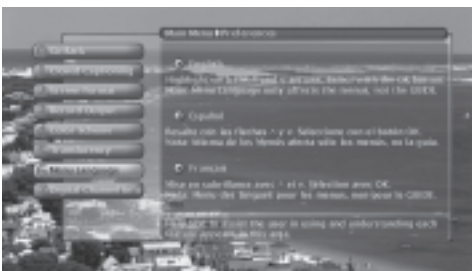

## Menu Language

The menu language can be changed to one of three languages: *English, Spanish* or *French*. The menu language can also be selected when using the *Assisted Setup* menu.

**Note:** Spanish and French are not available in the guide, browser, or in some software upgrade pop-up screens.

# Using the TV's Menu System

---

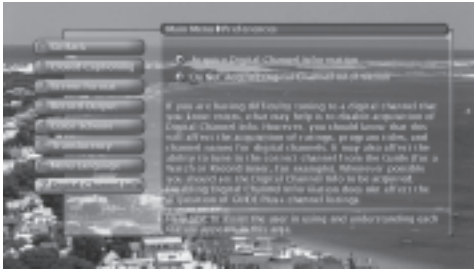

## Digital Channel Info

The *Digital Channel Info* option allows the TV to receive off-air TV guides. The default is set to *Acquire Digital Channel Information*. Disabling this option should be reserved as a last resort because you may not receive important terrestrial program guide information, such as program ratings, channel names, program titles, program times, etc.

**Notes:** When the TV is locked and you try to access the *Digital Channel Info* screen, the *Password Entry* screen appears and you must enter the password.

Disabling *Digital Channel Info* feature does not affect the acquisition of *GUIDE Plus+* channel listings.

Channels remain blocked or viewable in *Parental Control* feature regardless of the *Digital Channel Info* setting although the channels may appear to have changed.

# Using the TV's Features

## Chapter Overview:

- Channel Banner
- Digital or Analog Channels
- All About the GUIDE Plus+ System
- Parental Controls
- Auto Tuning
- PIP (Picture-In-Picture) Operation
- Web Browser

SCENIUM





# Using the TV's Features



## About the Channel Banner

The Channel Banner appears when you press the TV or INFO button on the remote. If an icon is grayed out (dim) in the banner, the feature is not available. The following list describes the items on the Channel Banner screen (left to right and top to bottom). Other displays that are not described here are self-explanatory.

The icons change appearance to show the item's status or availability.

- |   |   |
|---|---|
| <b>Program Title/Acquiring Channel</b>  | Displays title of program (if available) or <i>Acquiring Channel</i> appears when tuning a channel.   |
| <b>00:30</b>  | Use SKIP button on the remote to turn on the Commercial Skip timer, then change channels. Counts down the amount of time remaining before the TV tunes back to the channel where Commercial Skip was activated.   |
| <b>12:30 AM</b>   | The time when the TV shuts off as set by the Sleep Timer in <i>Time</i> menu.   |
| <b>12:39 PM</b>   | Displays current time if the Time feature is set in <i>Time</i> menu or GUIDE Plus+ system is set up.   |
| <b>888 - 888 WWWW</b>   | Displays current channel (analog/digital) and the station call letters, if available.<br><b>Note:</b> <i>The channel number display in the GUIDE Plus+ system and the banner may not match up because the GUIDE Plus+ system and banner may use different channel tuning mechanisms.</i>  |
|                                | Displays a channel logo or label (if available) and if the GUIDE Plus+ Label has been turned ON in the GUIDE Plus+ menu.  |
| <b>Antenna/Auto Tuning/DIVLink (Cable Box)</b>  | Displays input source (Air, Cable, Cable Box) or input/device to which the TV is tuned. Displays signal type (Air, Cable, Box) that you're viewing.   |
|  <b>CC</b>                     | Displays when Closed Captioning is available on the current channel and in the format selected in the <i>Caption Priority</i> menu.   |
|  <b>SAP</b>                    | Displays SAP or Audio language icon when the current analog channel is broadcasting SAP (Second Audio Program) information or when current digital channel is broadcasting an alternate audio track.  |
|  <b>Audio Format Icon</b>      | Displays sound mode icons (Mono, Stereo, Dolby surround, Four-channel surround, 4.1-channel surround, Five-channel surround).   |
|  <b>Parental Controls Icon</b> | Displays Parental Controls lock icon in Red when the TV is locked, Green when the TV is unlocked, and Yellow when the TV is temporarily unlocked.   |
| <b>MPAA - Not Rated</b>   | Displays current V-chip program ratings.  |
| <b>16:9 1080i HD</b>  | Displays signal format (4:3 or 16:9) and original resolution of the broadcast [e.g., 480i (i represents interlaced scan), 480p (p represents progressive scan), 720p, 1080i, etc.] and not the resolution of the TV. For example, 4:3 Normal, 480i SD (Standard Definition) or 16:9 1080i HD (High Definition). In 4:3 mode, displays the screen format (Normal, Zoom, Stretch). The 4:3 and 16:9 are the aspect ratios for the pictures and 480i and 1080i represent the horizontal lines of resolution. |

## Digital or Analog TV Channel

A single off-air antenna can pick up both analog and digital air channels. Channels can be made up of primary channels and subchannels.

**Note:** Subchannels (sometimes called "minor" channels) are channels associated with the primary channel (sometimes called the "major" channel).

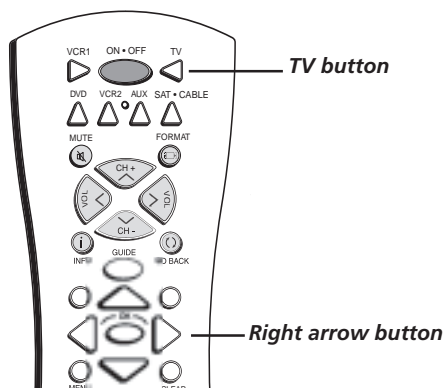
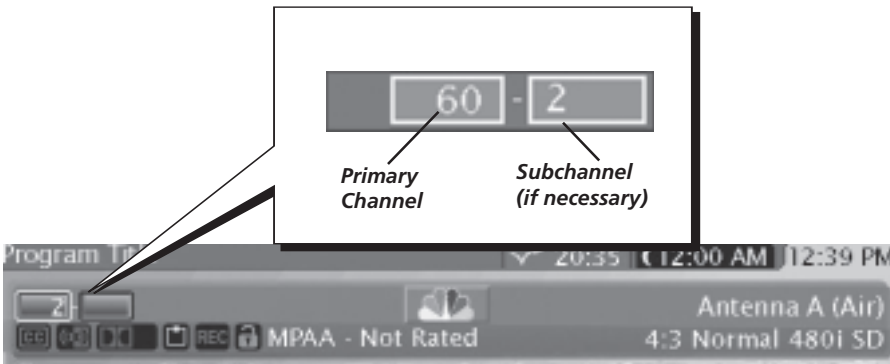

1. Make sure the TV is in TV mode by pressing TV on the remote control.
2. Enter the primary channel number (up to three digits). This number appears in the primary channel entry box. Press OK or wait a few seconds. If you don't enter a subchannel, the TV tunes to the lowest subchannel.
3. If the primary channel number has fewer than three digits and you want to enter subchannel numbers, press the right arrow to advance to the subchannel entry box.
4. Enter the number of the subchannel. This number appears in the subchannel entry box.
5. Press OK to tune to the channel or wait a few seconds.

**Note:** You can always use the channel up and down buttons on the remote control to change channels within the TV mode.

### Tip

If a digital and analog channel have the same primary channel number, use subchannel -0 to tune to the analog channel.

# Using the TV's Features

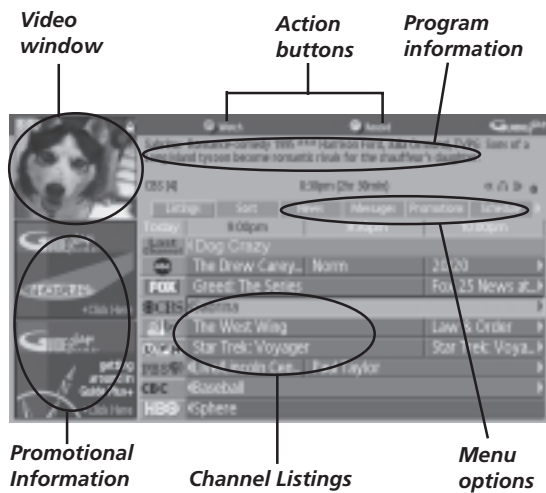

## About the GUIDE Plus+ System

The GUIDE Plus+ system is a no-fee, on-screen program guide that lists TV schedules for your area and allows your TV direct control of a cable box and/or VCR. You must first set up the GUIDE Plus+ system in order to view this on-screen program guide (see Chapter 1 for details).

There are six sections of the GUIDE Plus+ system:

- A video window
- Blue and Green Action buttons at the top of the screen
- Program information
- Promotional information
- Channel listings
- Menu options (Listings, Sort, News, Messages, Promotions, Schedule, Channels, Setup)

**Notes:** If you have cable and air signals, connect cable to Antenna A. If you have air signal only, connect it to Antenna A. Antenna A is where the GUIDE Plus+ system gets its Listings.

Whenever the GUIDE Plus+ system is activated in the TV, the last-viewed channel of Antenna A appears in the video window.

The GUIDE Plus+ system screens illustrated in this book are representations of what you are likely to see. Not all channels, programs, and GUIDE Plus+ information depicted will be available in your area. New features and options can be downloaded to the GUIDE Plus+ system, so these are subject to change also. The GUIDE Plus+ system doesn't display program listings for satellite TV.

### Tips

The GUIDE Plus+ system automatically comes up when you use the TV or ON/OFF button on the remote to turn on the TV. You can turn off this feature by selecting Setup from the GUIDE Plus+ Menu, selecting Options, then setting Auto Display to Off.

Also, since the program information provided by the GUIDE Plus+ system is based on your locale, you will need to run Setup again if you move to a different ZIP or postal code.

## Using the GUIDE Plus+ System

To enter the GUIDE Plus+ system:

- Press GUIDE on the remote or press MENU on remote then select *GUIDE Plus+* menu.

To exit the GUIDE Plus+ system:

- Highlight a program and press OK to exit the GUIDE Plus+ system and tune to the program (channel).
- Press GUIDE to exit the GUIDE Plus+ system and tune to the program (channel) displayed in the video window.
- Press CLEAR to exit the GUIDE Plus+ system and return to the original channel.

## The GUIDE Plus+ System Menus

The GUIDE Plus+ system offers different options on the Menu bar: *Listings, Sort, News, Schedule, Messages, Promotions, Channels, and Setup*. To access the Menu bar:

1. Press GUIDE (the GUIDE Plus+ programming guide appears).
2. Press MENU or up and down arrow buttons to select the Menu bar (the Grid Guide appears by default).

- Use the left and right arrow buttons to access other menus.
- Press OK, or MENU, or use the down arrow button to see the menu options.

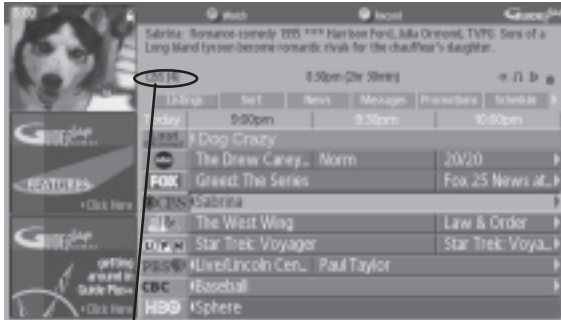

If you are highlighting a digital channel, the channel label will include a subchannel, such as CBS [4-08].

## Listings

The *Listings* appear each time you enter the GUIDE Plus+ system. They display the current programming for each channel. The current program of Antenna A is displayed in the video window.

- Press the up and down arrow buttons on the remote to browse channel listings and the channel up and down buttons to page through the listings. Use the right and left arrow buttons to browse future program listings.
- Press the Green button to skip ahead 24 hours; press the Blue button to go back 24 hours.
- To tune to a channel, highlight the program you want to view in the channel listings and press OK.
- Directly access a channel by using the number buttons. To access a digital channel, enter major # (13), right arrow, then subchannel #.

Use the Guide Action Buttons as described below.

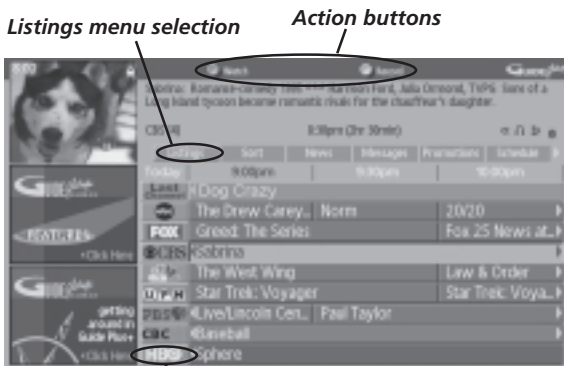

Network logos (if available) or labels

## Guide Action Buttons

The Blue and Green action buttons' actions or commands change according to where you are in the GUIDE Plus+ system. Be sure to look at the action bar before pressing the action buttons.

When highlighting a program, the following Action buttons appear:

- Watch** Press the Blue button on the remote to place a timer into the Schedule so the TV turns on and tunes to the program highlighted in the channel listing.
- Record** Press the Green button on the remote to place a timer into the Schedule so the VCR records the program highlighted in the channel listing.

If you have a cable box, changing channels on the TV causes the cable box channel to change while recording.

Record appears only if you have set up the GUIDE Plus+ system and specified your VCR type.

**Important Note:** You need to make sure that your VCR is tuned to the Line INPUT, and is turned off prior to recording start time. Do not change channels on the TV or VCR when making a recording.

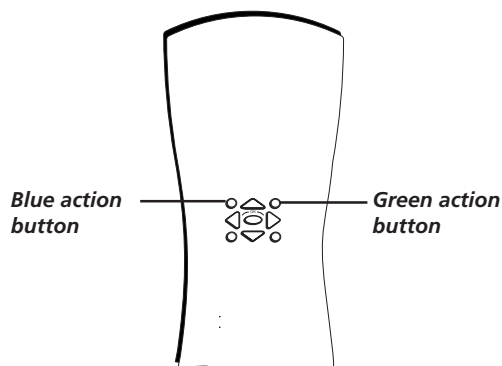

## Expanded Information

Press INFO on the remote to see additional program information.

# Using the TV's Features

## Locking the Video Window

When highlighting the channel names (the left column on the channel listing), the following Action buttons appear:

- **Lock/Unlock** Press the Blue action button to lock or unlock the video window to either stay at one channel as you browse the GUIDE Plus+ system (lock) or change as you browse through different channels (unlock). The PIP button also locks/unlocks the video window.



## Sort

The *Sort* menu lets you browse programs by different categories, such as Sports, Movies, and Children's programs. You can sort alphabetically by selecting "A-B-C."

- Use the arrow buttons to select the sort option.
- Use the Action buttons to schedule a watch timer or a record timer.

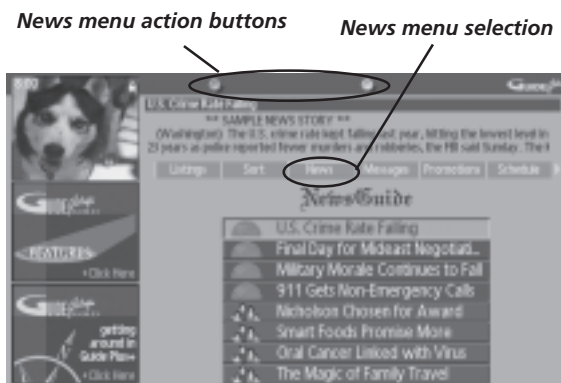

## News

The *News* menu lets you browse current news stories by headline.

1. Use the up and down arrow buttons to highlight a story.
  - Use the up and down arrows to browse the list one story at a time.
  - Use the channel up and down buttons to browse through the list one page at a time.
2. Press the right arrow or the INFO button to see all of the text for the story.

**Note:** If available, MSNBC is tuned while using the News feature.

## Schedule

The *Schedule* menu allows you to alter the programs for either viewing or recording programs.

### Schedule Menu Action Buttons

- **Remove** Highlight the *Watch* or *Record* timer you wish to remove from the schedule and press the Blue or Green button on the remote.
- **Change** Highlight the *Watch* or *Record* timer you wish to change and press the Blue or Green button on the remote to toggle the frequency between the following choices:
  - DAILY* records the same program each day Monday through Friday.
  - ONCE* records only on that day.
  - WEEKLY* records each week at the same day and time.
  - REGULARLY* records the program each week at the same day and time (only if the title is the same).



## Messages

Occasionally you receive messages regarding your GUIDE Plus+ system, as well as special programming information. You can access these messages from the *Messages* menu on the Menu bar.

## Promotions

The *Promotions* menu displays a list of all the promotions available through the GUIDE Plus+ system. Highlight the *Promotions* menu and then use the down arrow to scroll through the list. When the promotion you want to view is highlighted, press INFO (the promotional information appears on-screen). Press the right arrow to return to the Promotions list.

## Channels

You can customize the channel listing by enabling or disabling the display of certain channels. For instance, you may disable channels that you never watch. Use the action buttons to remove, replace, or change channels. Any changes in the guide *Channels* only affect the program guide display and not the channel lists in the television's *Main Menu*.

## Setup

The Setup menu allows you to access the GUIDE Plus+ setup information. You can do the following in the Setup menu:

- **Change system settings** Confirms the settings you completed in the GUIDE Plus+ system setup are correct.
- **Review options** Displays the GUIDE Plus+ auto display options.
  - On** Automatically displays the GUIDE Plus+ system when you press the ON•OFF or TV button on the remote control.
  - Off** Disables the GUIDE Plus+ system from being displayed automatically each time you turn on the TV.

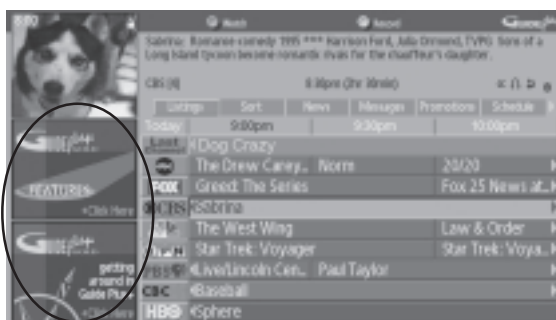

Promotional Information

## Promotions and Advertising

To find out more information about a program, advertisement or special, use the left arrow button to highlight the channel listing or promotional information box. Press INFO for more information.

You can view a list of all advertisements and promotions by selecting *Promotions* from the menu bar.

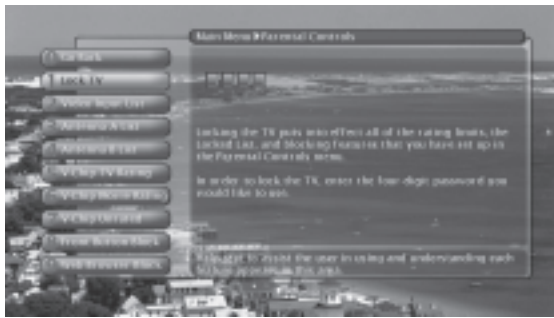

## Tip

You must lock the TV for the parental controls settings to be enforced.

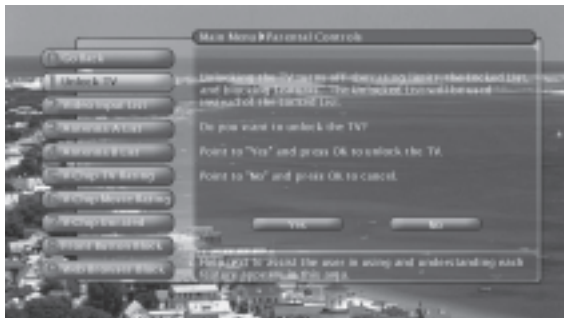

## Parental Controls

The *Parental Controls* menu allows you to program your TV so that children cannot see certain programs, channels, browser, or use the front panel controls. The *Parental Controls* menu also involves software inside your TV (referred to as V-Chip) which lets you program your TV so it won't display certain programs and movies based on violence, sex, or other content you may believe children should not view. Once you block programs, you or other adults can unblock programs by entering a password to unlock video or enter the password to edit the features in the *Parental Controls* menu. By default, the software inside your TV is turned "off," so if you don't want to use this feature, you can just ignore it.

The options of the *Parental Controls* menu are *Unlock/Lock TV*, *Video Input List*, *Antenna A List*, *Antenna B List*, *V-Chip TV Rating*, *V-Chip Movie Rating*, *V-Chip Unrated*, *Front Button Block*, and *Web Browser Block*.

## Lock/Unlock TV

Selecting this option lets you lock and unlock the parental controls and the TV using a password. It also affects the channel lists. If you select the *Unlock* option when watching TV, you see the channels that have a checkmark in the *Unlocked List*. If you select *Lock* when watching TV, you see the channels that are Viewable in the *Locked List*. If the TV is locked, all channels can be directly accessed by using the number buttons on the remote control but may not be viewed if they are blocked.

**Notes:** When locking the TV, you'll be asked to enter a password and then to re-enter the password a second time to re-confirm your password choice.

If you do not lock the TV, none of the settings for V-Chip, channel block, front panel block, and web browser block take effect.

If you forget your password, simultaneously press and hold the MENU/OK button on the front panel and VOLUME down button on the remote for three seconds. This resets the password only and unlocks the TV; all other settings in Parental Controls are not changed.

If you've locked the TV, set a record timer in the GUIDE Plus+ system and aren't there to provide your password, the recording takes place only if the program doesn't exceed the V-Chip ratings or you've unlocked your TV.



## Channel Lists (*Video Input List*, *Antenna A List*, *Antenna B List*)

The channel lists contain the following information: major channel number (with subchannel number only if a digital channel), channel call letters (when channel is tuned), *Locked List*, and *Unlocked List*. The major channels listed in *Antenna A List* and *Antenna B List* for off-air or cable sources are based on the channel search results. If a major channel is not found, then it is not listed. A channel search does not affect the Video Input List; all video inputs are listed.

For each major channel 0 through 125 found through channel search in Antenna A and B Lists, there are six subchannels (1, 2, 3, 4, 5, and 6 to 999). The subchannels are the same for every major channel and are not based on which subchannels a broadcaster is actually broadcasting. Subchannels are not supported for major channels 126 through 999. An analog channel (major) and a digital channel (subchannel) can share the same channel number and are both listed in the Antenna A/B List screens.

## Editing Channels in the Channel Lists

All the lists are only editable through the *Unlocked List* and *Locked List* in the *Parental Controls* menu. You can remove or “hide” a channel from the *Unlocked List* by removing the checkmark in the checkbox. Also, you can remove or “hide” a channel from the *Locked List* by selecting *Blocked* in the *Locked List*. When you press the channel buttons, that channel will be skipped. When the TV is locked, you can still access the channel directly by using the number buttons on the remote control but may not be able to see the video until a valid password is entered.

You can also add ALL or delete ALL channels in a list by changing the checkbox or choice field in the line that says *All channels*, but be very careful because you could erase all of your selections with one selection.

**Notes:** *The Guide Plus+ system and Parental Controls both have a channel selection feature.*

*The Channel feature in the GUIDE Plus+ system controls which channels appear in the guide and has no effect on which channels appear in the channel lists, and vice versa.*

*If a cable box is connected to Antenna A, the channel list can be edited for Antenna A in the Parental Controls menu. If a cable box is connected via INPUT1, the channel list cannot be edited. You can only use channel up/down or use the number buttons.*

## How V-Chip Works

The V-Chip software reads a code that most broadcasters send with programs. That code tells the software the program's age-based rating (TV-MA, TV-14, etc.) and content themes [(Violence (V), Adult Language (L), etc.)]. If you have blocked the rating and/or content themes that the program contains and the TV is locked and you tune to a program whose rating exceeds the rating limit you set, you will receive a message telling you that the program is not approved for viewing.

Broadcasters are not required to provide content themes, so programs received with no content themes will only be blocked if you block their age-based rating and the TV is locked. You can also block out programs that have been given a rating of “Not Rated,” and programs that are considered “unrated.” The TV age-based ratings and content themes you can block are in the table on the next page.



## V-Chip TV Ratings

The *V-Chip TV Rating* lets you decide which TV programs can and cannot be viewed. To set TV programming limits:

1. Choose *Parental Controls* from the Main menu. If *Parental Controls* (TV) have previously been locked, you must enter your password.
2. Highlight and select *V-Chip TV Rating*.
3. Once you get to the *V-Chip TV Rating* screen, use the arrow buttons and OK on your remote to change the status of a TV program rating or content theme from *Viewable* to *Blocked*.

Proceed to the next sections for more details about how to change the status of TV program limits.

# Using the TV's Features

## The V-Chip Rating Limit Screen

The following is an example of where items are located within the V-Chip TV Rating screen.

### Rating Field

Lets you select from a list of age-based ratings you can block or view.

### Rating Settings Area

Lets you see the current block/view state of age-based ratings and associated content. The Viewable (V) settings are coded in green, and the Blocked (B) settings are coded in red.

### Rating Status Field

Lets you select whether the status of the age-based rating limit to the left is Viewable or Blocked.

### Content Themes

Lets the content themes you can block or view.

### Content Status Fields

Lets you select which content themes to view for the selected rating, and whether the status of the content theme is currently Viewable (V) or Blocked (B).

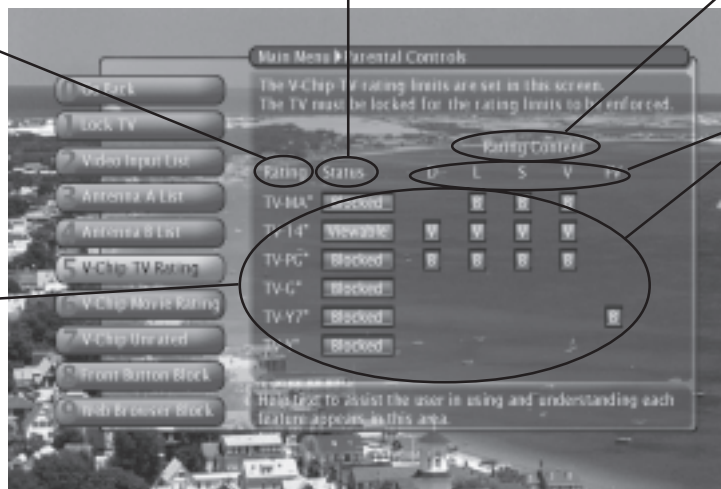

Age-Based Rating	Description and Content Themes for Age-Based Ratings
<b>TV-MA</b>	<b>Mature Audience Only.</b> Specifically designed to be viewed by adults and may be unsuitable for children under 17. It contains one or more of the following content themes: crude indecent language (L), explicit sexual activity (S), or graphic violence (V).
<b>TV-14</b>	<b>Parents Strongly Cautioned.</b> Contains some material that many parents would find unsuitable for children under 14. Parents are strongly urged to exercise greater care in monitoring this program and are cautioned against letting children under the age of 14 watch unattended. This program contains one or more of the following content themes: intensely suggestive dialogue (D), strong coarse language (L), intense sexual situations (S), or intense violence (V).
<b>TV-PG</b>	<b>Parental Guidance Suggested.</b> Contains material that parents may find unsuitable for younger children. Many parents may want to watch it with their younger children. The program contains one or more of the following content themes: some suggestive dialogue (D), infrequent coarse language (L), some sexual situations (S), or moderate violence (V).
<b>TV-G</b>	<b>General Audience.</b> Most parents would find this program suitable for all ages. It contains little or no sexual dialogue (D) or situations (S), no strong language (L), and little or no violence (V).
<b>TV-Y7</b>	<b>Directed to Children 7 years and older.</b> Designed for children ages 7 and above. It may be more appropriate for children who have acquired the developmental skills needed to distinguish between make-believe and reality. Themes and elements in this program may include mild fantasy violence (FV) or comedic violence, or may frighten children under the age of 7.
<b>TV-Y</b>	<b>All Children.</b> Themes and elements in this program are designed for a young audience, including children from ages 2-6. It is not expected to frighten younger children.

## Blocking Age-Based Ratings

You can automatically block all program ratings above a specified age-based rating level. For example, if you only want your child to watch programs that have a TV-G rating and lower (in other words, you want the child to watch TV-G, TV-Y7, and TV-Y), then you need to block out higher ratings.

To block programs with higher ratings:

1. First, determine the lowest level rating you don't want the child to watch (see chart of age-based ratings on previous page).
2. Highlight the lowest rating you do not want the child to watch. In the example discussed above, you would highlight TV-PG, since the highest rating you want the child to watch is TV-G.
3. Press the OK button to toggle between *Viewable* and *Blocked*. The status for the rating listed to the right and all higher ratings automatically change to *Blocked* (and *B*).
4. Select *Lock TV* from the *Parental Controls* menu. Enter a password and re-enter password a second time to confirm the password.

Hierarchy of Age-Based Ratings	
TV-MA	<i>Mature Audience Only</i>
TV-14	<i>Parents Strongly Cautioned</i>
TV-PG	<i>Parental Guidance Suggested</i>
TV-G	<i>General Audience</i>
TV-Y7	<i>Directed to Children 7 years and older</i>
TV-Y	<i>All Children</i>

## Viewing Age-Based Ratings

After you block age-based ratings, you have the option of changing some of the ratings back to *Viewable* (V).

1. Determine which blocked rating you want to view.
2. Use the up and down arrow buttons to highlight the rating with a status of *Blocked*.
3. Press the OK button to select *Viewable*.

**Notes:** The content status fields corresponding to the unblocked rating become *Viewable* as well. They and the age-based rating status are the only fields that automatically change back to *Viewable* when you complete this process.

You must remember to lock the TV for rating limits to take effect.

## Blocking Specific Content Themes

You can block programs based on their content. When you block a content theme for a particular rating, you automatically block that content theme for higher rated programs as well.

For example, if you do not want your child to watch programs that have adult language (L) rated TV-PG or higher, then you could block out all programming TV-PG and above containing adult language.

To block program content:

1. Determine the lowest level of content you don't want the child to watch.
2. Use the up and down arrow buttons on the remote to highlight the age-based ratings that correspond with the lowest content you do not want the child to watch. (In the example above, you would highlight TV-PG.)
3. Press the OK button to change content status from (V) *Viewable* to (B) *Blocked*. All higher ratings' content themes change to *Blocked*.

**Notes:** Broadcasters are not required to provide content themes or age-based ratings.

You must remember to lock the TV for rating limits to take effect.

# Using the TV's Features

## Viewing Specific Content Themes

If you block specific content themes, you have the option of going back and changing some of the content themes back to *(V) Viewable*:

Content Themes	
D	Sexually explicit dialogue
L	Adult language
S	Sexual situations
V	Violence
FV	Fantasy Violence

1. Determine the content themes you want to change to *(V) Viewable*.
2. Use the up and down arrow buttons to highlight the age-based rating whose content theme you want to change to *Viewable*
3. Press the OK button to change its status back to *V*. Your child would then be able to watch programs with TV-14 adult language content, but not programs with TV-PG or TV-MA language content.

**Note:** Only the content theme status corresponding to TV-14 (L) language changes to (V) View. Higher rated content themes, such as that for TV-MA language, do not change.

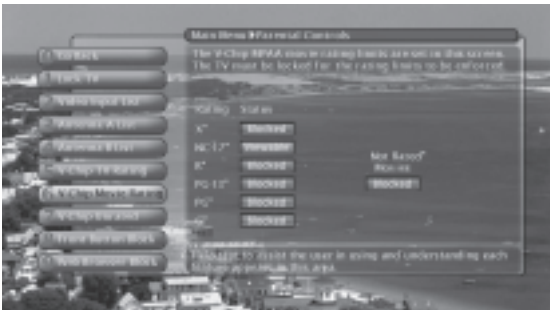

## V-Chip Movie Rating Limit

You set movie (MPAA) rating limits by blocking movies rated above a specified rating. How to block movie ratings and view movie ratings is explained in the next two sections.

To access the *V-Chip Movie Rating* menu:

1. Press MENU on the remote control (the *Main Menu* appears).
2. Select *Parental Controls*.
3. Select *V-Chip Movie Rating*.

## Blocking Movie Ratings

If you only want your child to watch movies that have a PG rating and lower (in other words, movies rated PG and G), then you could automatically block out all other movies with higher ratings.

To block movies:

1. Highlight the rating that is the lowest rating you don't want the child to watch. (In the example above, you would highlight the rating status button corresponding to PG-13, since the highest rating you want the child to watch is PG.)
2. Press the OK button to change the button from *Viewable* to *Blocked*. All higher ratings automatically change to *Blocked*.
3. If the TV is not locked, you must lock it so the movie rating limits will take effect.

**Note:** Some movies may be given a *Not Rated (NR)* rating. After blocking movie ratings, you must set NR to *Viewable* separately to view NR movies.

## Viewing Movie Ratings

After you block movie ratings, you have the option of changing some of the rating status buttons back to *Viewable*:

1. Highlight the rating you want to view.
2. Press the OK button to change the button from *Blocked* to *Viewable*.

For example, if movies with a rating of PG-13 and higher are blocked, you can change the rating status corresponding with NC-17. Your child would then be able to watch all movies with a G, PG, and NC-17 Rating.

3. Exit the screen, and be sure the TV is locked.

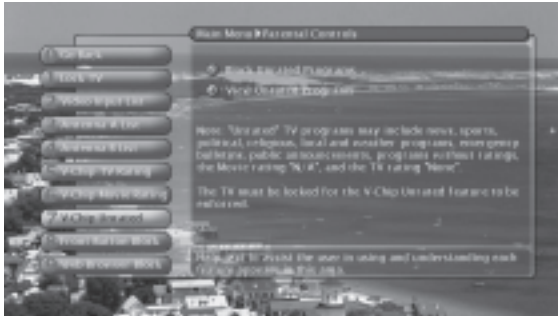

## V-Chip Unrated Program Block

Selecting this option lets you decide if programs that the V-Chip recognizes as "unrated" can be viewed. Note that "unrated" TV programs may include news, sports, political, religious, local and weather programs, emergency bulletins, public announcements, and programs without ratings, the movie rating "N/A," and the TV rating "None."

- Block Unrated Programs** All unrated programs are available.
- View Unrated Programs** All unrated programs are not available.

**Note:** You must remember to lock the TV for rating limits to take effect.

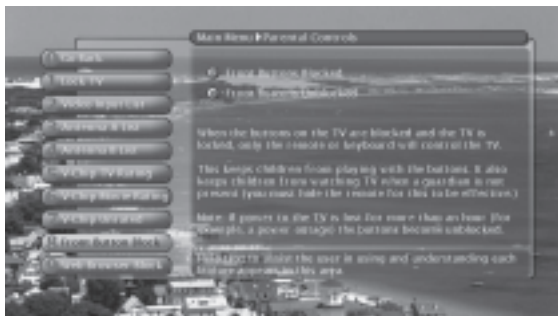

## Front Button Block

Selecting this option lets you block (disable) or unblock (enable) the TV's front buttons. The remote still tunes to any channel. *Front Panel Block* can:

- Keep children from watching TV when the parent is not present.
- Keep young children from playing with the buttons on the TV.

(When using this as a *Parental Control* method, you should remove access to any remote that is capable of operating the television while you have the front panel blocked.)

Don't forget to lock the TV after you select *Blocked*. If you do not, the front panel block will not take effect.

**Note:** If power to the TV is lost for more than an hour, the buttons become unblocked. Blocking the front buttons does not disable the front input.

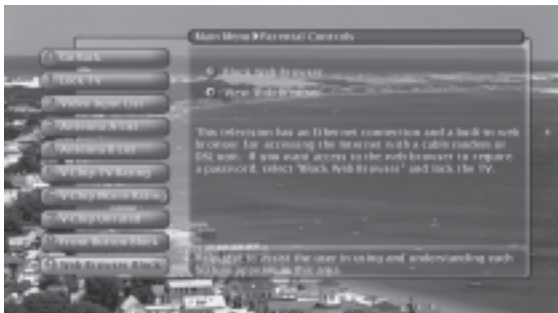

## Web Browser Block

Selecting this option lets you decide if the web browser can be accessed.

- Block Web Browser** Need a password to view web content
- View Web Browser** Web browser is accessible.

Make sure the TV is locked. If you do not, *Block Web Browser* will not block browser access if it is set the *Block Web Browser*.

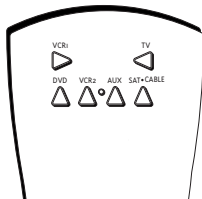
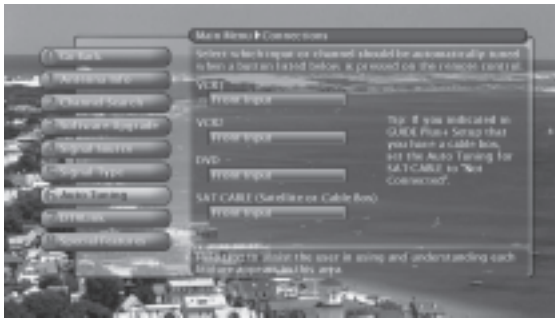

With the Auto Tuning feature, you can set up the TV to tune to the channel you want to watch by pressing that component's button. Auto Tuning for the TV button cannot be set.

## Auto Tuning Feature

The way you set up the *Auto Tuning* feature in the TV's menu corresponds to the component buttons on the remote and the way you have each component connected to your TV. When you set auto tuning, you're telling the TV what channel to tune to when you press the VCR1, VCR2, DVD, or SAT•CABLE button on the remote control.

1. Press MENU (the *MAIN MENU* appears)
2. Highlight *Connections* and press OK.
3. Highlight *Auto Tuning* and press OK
4. Highlight the component button field and continually press OK to scroll through the selection of inputs.

The choices and a brief explanation follow:

**Not Connected** Choose this if you don't have this particular component connected to the TV, or if you don't want the TV to automatically tune to the correct channel when you press one of the component buttons on the remote.

**Channel 2, 3 or 4 Antenna A** Component is connected to the ANTENNA A jack on the back of the TV, and you want the TV to tune to channel 2, 3, or 4 when you press the corresponding button on the remote. Reminder: make sure the component's Channel 2/3 or 3/4 switch is set to match the channel in *Auto Tuning*.

**Channel 2, 3 or 4 Antenna B** Component is connected to the ANTENNA B jack on the back of the TV, and you want the TV to tune to channel 2, 3, or 4 when you press the corresponding button on the remote. Reminder: make sure the component's Channel 2/3 or 3/4 switch is set to match the channel in *Auto Tuning*.

**Front Input** Component is connected to the *S-VIDEO IN* or *VIDEO IN* jack on the front of the TV and you want the TV to tune to the front video input when you press the corresponding button.

**Input 1, Input 2** Component is connected to a VIDEO or S-Video jack on the back of the TV and you want the TV to tune to the video input channel when you press the corresponding button.

**Input 3, Input 4** Compatible component video source, such as a DVD player or satellite receiver, is connected to the composite/component VIDEO INPUT jacks (Y•Pb•Pr) on the back of the TV and you want the TV to tune to the composite/component video input when you press the corresponding button.

**Input 5** Component is connected to the DVI-HDTV jack on the back of the TV and you want the TV to tune to this input when you press the corresponding button.



## PIP (Picture-in-Picture) Operation

The PIP (Picture-In-Picture) feature lets you display a second, smaller analog (NTSC format) picture on top of the main analog picture. The main and PIP channels must be from the same antenna A or B; you cannot have the main picture from Antenna A and the PIP picture from Antenna B. However, inputs can use PIP regardless if Antenna A or B is used for the main or PIP picture. You will only be able to use the PIP window and main picture with analog channels.

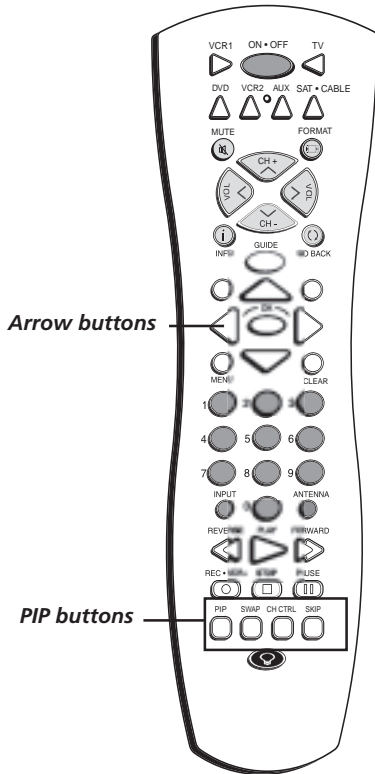

### PIP Buttons

There are certain remote buttons that control the way the PIP window works:

**PIP** Brings up the PIP window. Press PIP again to remove the window.

**Arrows** Let you move the PIP window to different areas of the screen.

**SWAP** Switches, or “swaps,” the video from the PIP window with the main picture.

**CH CTRL** (Channel Control) Lets you switch channel control between the PIP window and the main picture. To determine whether you are controlling the PIP or the main picture, look at the channel banner as you change channels. The triangular indicator is beside the channel number for the picture you’re controlling with channel up/down, number buttons, etc.

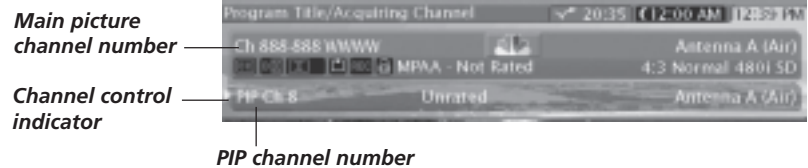

### Using the PIP Feature

While you may use PIP in different ways, this basic PIP scenario should get you started. When watching an analog channel, follow these steps.

1. Press the PIP button on the remote control. The PIP window appears on the screen and *Channel Control* is automatically put on the PIP window.
2. Use the channel up and down or digit buttons to change the PIP channel.
3. To change the program in the main picture window, press CH CTRL. Then use the channel up and down or digit buttons. To go back and forth between controlling the PIP window and the main picture, press the CH CTRL button.

#### Tip

A typical use of SWAP is to scan through channels in the PIP window, and when you find a channel you like, press SWAP to display that channel in the main picture, sending the current channel to the PIP window.

# Using the TV's Features

## PIP Problems?

- If you are channel surfing and the PIP disappears, you may have tuned to a digital channel. To view PIP and the main picture, make sure that both the main and PIP channels are analog inputs, or signals. Continue changing the channel until you find an analog (NTSC format) channel. The PIP window will reappear.



The message "PIP Not Viewable or Exceeds Rating" in the channel banner lets you know that PIP is not available on this channel and you should tune to another channel.

- If you press PIP and the PIP box is grayed, you may have movie or TV rating limits set. These limits may block your access to the PIP channel. For information on removing limits, see the section "Parental Controls."
- You cannot view closed captioning in the PIP window.
- PIP channel skips all digital (ATSC) TV channels and tunes to analog channels.
- PIP cannot be displayed from component inputs.

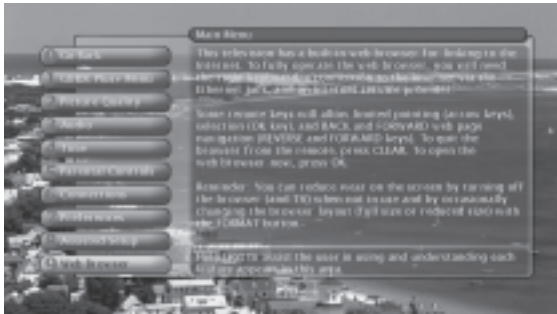

### Tips

Inputs cannot be viewed in the video window of the browser.

If you use the video window in the browser and you press channel up/down and the video window seems to disappear, this means you've either tuned to a channel which is blocked or has a weak signal. Use the channel up/down to go to another channel.

You can use channel up/down to tune to a different channel in the video window. Number keys cannot be used to tune channels in the video window.

## Using the Web Browser

You can start the browser on your TV by selecting it from the main menu. The TV front panel and remote control provide basic navigation without a keyboard. If you launch the browser from the main menu, a message will pop up to suggest that you use a keyboard to connect to the Internet.

The optional keyboard will allow you to get optimum use of web browser features. The keyboard KBR755TA1 is available through URL: [www.rca.com/keyboard](http://www.rca.com/keyboard) or order the keyboard through a toll free number, 800-798-5875.

When the browser is started for the first time, the browser goes to an RCA website. All FAV keyboard buttons are also initially programmed to that site. The FAV SEARCH button on the keyboard defaults to a search site but you can reprogram it.

The FORMAT button on your remote (or keyboard) allows you to cycle through various combinations of a less than full screen browser and some TV video. Just press the button again to use a different format. If you usually use this method to browse, change the layout periodically to reduce the effects of uneven screen aging.

To close the browser entirely, press CLEAR on the remote. You may discover that other browser windows are open. This may be the result of a pop-up window being delivered from the site you were viewing.

**Note:** The browser doesn't handle streaming video or audio and some animated graphics.

## Browser Screen Burn Prevention

If the browser is idle for a period of time, a pop-up message appears to remind you to turn it off when you are not using it to prevent uneven wear of the screen. Remember that fixed images tend to “burn” in. In browser mode, the contrast level of your TV is automatically set to a reduced level to help slow the effects of uneven screen aging.

Additional steps have been taken to mitigate uneven screen aging on your TV. You will notice that the usual browser menu and on-screen buttons that you may be accustomed to working with on a PC are not displayed on-screen. Instead, these functions are on your remote or optional keyboard.

## Saving Your Favorite URLs

Program any favorite (FAV) key, including HOME and SEARCH, to any URL (website address). After you've browsed to a favorite URL, just press the desired key and hold it until a message appears. That site's URL will be assigned to the key you pressed. The next time you press the key briefly, the browser will automatically go to the site you saved.

Additional storage locations for favorite website are available by pressing SHIFT, CTRL or ALT at the same time you press a FAV key. This provides an additional 21 locations for storing favorites.

If you have the optional keyboard, previously visited sites are also available as a drop-down listing from the address bar. The list can hold only a certain number of addresses, so at some point a new address will replace the oldest one.

## Controlling the Web Browser

As stated previously, the remote control and front panel buttons support only basic browser functions. Below is a table that shows which buttons work what function.

Web Browser Button Interaction		
Remote:	Front Panel:	Browser Function:
MENU	MENU/OK	Close browser and opens main menu
CLEAR		Quits the browser
SWAP		Displays the previous browser window; BACK
CH CTRL		Displays the next browser window; BACK
STOP		Stops loading the current page; STOP
PLAY		Reloads the current page; REFRESH
REVERSE		Go to the previous page if one exists; BACK equivalent on optional keyboard
FORWARD		Go to the next page if one exists; FORWARD equivalent on optional keyboard
FORMAT		Toggles between Full-Size browser and browser plus video in multiple layouts
Up/Down/Left/Right Arrow		Moves the cursor in the web page
GUIDE		Closes the browser and opens the guide
REC•VCR+		Closes the browser and opens the guide
	CH Up/Down	Changes channels if video window is displayed
	VOL Up/Down	Changes volume if video window is displayed

**This page is intentionally left blank.**

# Reference

- Troubleshooting
- Specifications and Features
- Accessory Information
- Limited Warranty
- Care and Cleaning-
- Index

SCENIUM

## Troubleshooting

Most problems you encounter with your TV can be corrected by consulting the following troubleshooting list.

### *TV Problems*

---

#### **TV won't turn on**

- Press the TV button or ON/OFF button while remote is in TV mode and there's a source of power to the outlet or outlet strip.
- Make sure the TV is plugged in.
- Check the wall receptacle (or extension cord) to make sure it is "live" by plugging in something else.
- Something might be wrong with your remote control. Press the POWER button on the front of the TV. If the TV turns on, check the remote control solutions on page 70.
- The front panel controls may be locked (disabled). Use the remote control to unlock the front panel controls by selecting the *Front Button Block* in the *Parental Controls* menu and choosing *Unblocked*.
- When you first plug your TV into an outlet, the Power LED on the front panel will light for approximately 15 seconds and then go off during the initialization of the TV. The TV can only be turned on after the Power LED goes off. This happens every time power is reapplied to the TV.

#### **Buttons don't work**

- If you're using the remote control, press the TV button first to make sure the remote is in TV mode.
- The front panel controls may be locked (disabled). Use the remote control to unlock the front panel controls by selecting the *Front Button Block* in the *Parental Controls* menu and choosing *Front Buttons Unblocked*.
- Unplug the TV for five minutes and then plug it back in. Turn the TV on and try again.

#### **TV turns off while playing**

- Sleep Timer, Wake-up Timer, or Watch feature may have been activated. Go to page 38 or 59 for instructions.
- Electronic protection circuit may have been activated because of a power surge. Wait 30 seconds and then turn on again. If this happens frequently, the voltage in your house may be abnormally high or low.
- The sleep timer may be set.
- Unplug. Wait five minutes. Plug in again.

#### **TV turns on unexpectedly**

- Wake-up Timer feature or Watch from the GUIDE Plus+ system may have been activated. Go to page 38 or 59 for instructions.

#### **Blank screen**

- Make sure the component connected to the TV is turned on.
- Try another channel.

#### **Unusual sound quality**

- Check the *Graphic Equalizer*, *SRS*, and *Sound Logic* settings.

#### **No sound, picture okay**

- Maybe the sound is muted. Try pressing the volume up button to restore sound.
- Maybe the speakers are turned off. Check the FIXED/VARIABLE OUT control panel in the Audio menu.

- If using an S-Video connection, DVI-HDTV, component and video remember to also connect the component's L and R AUDIO OUT jacks to the TV's L and R INPUT jacks.
- Check the position of the INT W/EXT SURR and EXT switch on the back of the TV.
- Make sure the correct *Audio Processor* mode (*Mono*, *Stereo*, *SRS*, *FOCUS* and *TruSurround*) is selected.

## Can't select certain channel

- May be blocked or not approved in the *Parental Controls* menu.
- If using a VCR, check to make sure the TV/VCR button on the VCR is in the correct mode (press the TV/VCR button on your VCR).

## Noisy stereo reception

- May be a weak station. Use Audio menu to choose *Mono* sound.

## No picture, no sound but TV is on

- Maybe the cable/air function is set to the wrong position. Select *GUIDE Plus+ Menu* from the Main menu, select the *GUIDE Plus+ Setup* option, and provide the correct information on the following screens. Go to pages 20-21 for detailed instructions.
- The channel might be blank — change channels.
- If you're watching your VCR and it's connected with coaxial cable to the CABLE/ANTENNA jack, tune the TV to channel 3 or 4 (whichever channel is selected on the 3/4 switch on the back of your VCR). Also check to make sure the TV/VCR button on the VCR is in the correct mode (press the TV/VCR button on your VCR).

## Sound okay, picture poor

- Check antenna connections. Make sure all of the cables are firmly connected to the jacks.
- Try adjusting sharpness function to improve weak signals. Go to page 54 for more instructions.

## Black box appears on the screen

- Closed-captioning might be on. Check the *Caption Display* control panel in the *Preferences* menu. Go to page 62 for more instructions.

## Every time I turn on the TV, the Guide is on the screen

- The GUIDE Plus+ system automatically appears on the screen when you use the TV button on the remote to turn on the TV. You can turn off this feature by pressing GUIDE on your remote control and then select the Menu bar. Press the right arrow button to select *Setup*. Choose *Review options* and select *OFF*.

# GUIDE Plus+ System Problems

---

## GUIDE Plus+ setup won't turn off tape for VCR setup and/or channel 02 cable box

- Check to see if the G-LINK wands are positioned correctly in front of components' remote sensors.
- GUIDE Plus+ system control of cable box is slower than direct control of the box itself. Keep this in mind when changing channels.
- You may have an incorrect GUIDE Plus+ Channel Lineup. The guide may get out of sync with the cable provider. Use the *GUIDE Plus+ Setup* in the *GUIDE Plus+ Menu* to change the zip code to 99999. Turn the TV off for 10 minutes. Use Setup again to change the zip code back to the correct value. If asked, be sure to select the correct channel lineup from the on-screen list.

# References

---

## Program information doesn't download

- Review your setup information and make sure it's correct. Press MENU on the remote and select *GUIDE Plus+ System* menu and then *Setup*. Go to page 20 for detailed instructions about the GUIDE Plus+ Setup menus.
- The TV must be off to download information. Leave your TV off overnight, for at least 10 hours, to receive the initial download for your area.
- If you're using a cable box, leave it on so you can receive program information.
- The GUIDE Plus+ system doesn't display program listings for satellite TV.

## Scheduled Watch or Record doesn't occur

- Check Schedule for timer conflicts. Go to page 38 for instructions.
- Make sure the wands of the G-LINK cable are placed in front of the remote sensor(s) on the component(s).
- Make sure your VCR is turned off during the time you've scheduled to record a program because the system turns the VCR on when it starts recording (if it's already on when recording starts, the system will turn it off).
- Make sure there is a tape in the VCR and that the VCR is connected properly.
- Make sure VCR is tuned to the line input. Don't change channels.
- Be sure that you set up the VCR in the *GUIDE Plus+ Setup* menus. If you don't complete the *Configuring for a VCR* steps successfully, the Record option won't be available. Go to page 22 for detailed instructions.
- If a cable box is attached to your TV, make sure you set it up correctly in the *GUIDE Plus+ Setup* menus. Go to page 21 for detailed instructions.
- The guide comes up each time you turn on the TV. You can disable the guide by going to the Auto-on feature in the *Guide Setup* menu and select *Review Options*.

## The Remote Control Doesn't Work

---

- Something might be between the remote and the remote sensor on the component. Make sure there is a clear path.
- Maybe the remote isn't aimed directly at the component (TV or VCR) that you're trying to operate.
- Maybe remote is not in TV Mode. Press the TV button so the remote controls the TV.
- Maybe batteries in remote are weak, dead, or installed incorrectly. If batteries are weak, you will not be able to activate backlighting on the remote; instead, backlight will blink once when activated. Put new batteries in the remote. (Note, if you remove the batteries, you may have to reprogram the remote to operate other components.)
- You might need to drain the remote's microprocessor: remove batteries and press the number 1 button for at least 60 seconds. Release the 1 button, replace the batteries, and (if necessary) program the remote again.



## ***Problems with V-Chip/Parental Controls***

---

### **The rating limits don't work**

- You must lock the settings. Go to the *MAIN MENU* (press MENU on your remote), select *Parental Controls* (press 5 on your remote), select *Lock TV* (press 1 on your remote).

### **I don't remember my password and I want to unlock the TV**

- If you forget your password, simultaneously press and hold MENU/OK on the television and VOL down on the remote for 3 seconds. Nothing appears on the screen, Parental Controls simply unlock and you can re-enter a password via *Lock TV*.

### **The V-Chip won't let me watch a program even though it's not rated as violent.**

- Maybe the movie was given an NR (Not Rated) status. After you block movie ratings, you must set *V-Chip Unrated to View* separately in order to view movies with an NR rating.

# References

---

## HDTV Specifications\*\*

### Tuning Capability

Channel Tuning .....	NTSC/ATSC
Digital Cable Compatibility .....	DTVLINK, DVI/HDTV, ..... Component

### Video

Adaptive Video Noise Reduction .....	Yes
Adjustable Color Warmth .....	Yes
4:3 Format Control (Screen) .....	Normal, Zoom, Stretch
Auto Color Control .....	Yes
Convergence (Auto & Manual) .....	Yes
Optimum Contrast, High-Resolution Screen .....	Yes
Integrated Shield .....	Yes
Viewing Angle (Degrees) .....	160
Comb Filter .....	Digital Frame Comb (3D Y/C)
Dynamic Focus .....	Yes
High Performance Scan Velocity Modulation (SVM) .....	Yes
Horizontal Resolution (Picture Width) .....	1200
Picture Tube Pitch .....	Screen .52mm
Picture Power (Watts) .....	42
Scan Rate Converter .....	Yes
3:2 Pull Down (Film Mode) .....	Reverse
Picture Presets .....	Bright, Normal, Soft, Personal
Wide Band Video Amplifier .....	Yes

### Sound

Audio Power (Watts) Front Speakers .....	15 Watts/Channel
Integrated Subwoofer/Boomer .....	30 Watt-Sub
Graphic Equalizer .....	7 Band
Front Speakers .....	2--130mm Midrange Drivers ..... plus 2 - 19 mm Tweeters
Fully Enclosed Speaker System .....	Yes
Balance Control .....	Yes
Broadcast Stereo w/dbx <sup>†</sup> Noise Reduction .....	Yes
Matrix Surround Sound .....	Yes
Second Audio Program (SAP) .....	Yes
Sound Logic Audio Leveler .....	Yes
SRS TruSurround .....	Yes
SRS Focus .....	Yes

### Convenience

Web Browser .....	Yes
Auto Channel Search (Full and Quick) .....	Yes

<sup>†</sup> dbx is a registered trademark of Carillon Electronics Corporation.

\*\*Specifications are subject to change.

Multilingual On-screen Display .....	English, French, Spanish
Auto Tuning (One-button Launch) .....	Yes, four components
Closed Captioning .....	Analog & Digital
Front Button Bock .....	Yes
Commercial Skip .....	Yes
Parental Control with V-Chip .....	Yes
Picture Reset .....	Yes, in Menu
Picture-in-Picture (PIP) .....	Analog on Analog
Picture Memory Presets for Video Inputs .....	Yes
(Individual Memory)	
Guide Plus+ System with Digital Channels .....	Yes
One Touch VCR Record w/Guide Plus+ System .....	Yes
Picture in Guide Plus+ System .....	Yes
Clock (Time), Sleep and Wake-up Timers .....	Yes

## Front Panel

Stereo Headphone Jack .....	3.5mm Stereo Mini-jack
Front A/V Input .....	Composite with S-Video

## Back Panel Inputs/Outputs

A/V Inputs .....	2 - S-Video / Composite
Component/Composite Video Inputs .....	2 - Y PrPb (RCA Jacks)
.....	SYNCHROSCAN
Antenna/Cable Inputs .....	2 - RF
DVI-HDTV Input with Audio Inputs .....	1
Broadband Connection (Ethernet RJ45) .....	1
DTVLink (IEEE 1394) .....	1
Record Output (Composite with Audio) .....	1
Digital Audio Output .....	1
External Speaker Terminals .....	Yes
Fixed or Variable Audio Outputs .....	1 set, menu switchable
External Center Channel Input .....	Maximum amplifier power
.....	rating 60 watts into 8 ohms
G-LINK Jack .....	Yes

## General Specifications

	HD52W140	HD61W140	HD65W140
Screen Size (Measured Diagonally)	52"	61"	65"
Dimensions (H X W X D)	51.5 x 48.5 x 23	57.75 x 56.5 x 23	61.625 x 59.75 x 25.75
Aspect Ratio	16:9	16:9	16:9

## Accessory Information

The following accessories are available from most dealers and electronics supply stores in case you want to position your components farther apart or need additional cables.

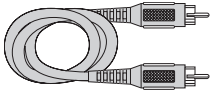

**Standard Audio/Video cable** with RCA-type phono plugs. VH83

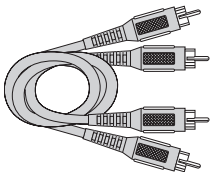

**Monaural VCR Dubbing Audio/Video Cable** is a double cable that lets you connect the video and audio jacks of two VHS VCRs to duplicate tapes. It can also be used to connect a VCR to your TV. The cable is color-coded and shielded. It has RCA-type phono plugs on each end. Gold-Tipped cable, VH83 (6-ft)

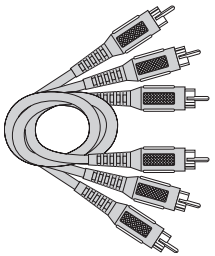

**Stereo VCR Dubbing Audio/Video Cable** is a triple cable that lets you connect the VIDEO and AUDIO jacks of stereo components. Gold-Tipped cable, VH84 (6-ft)

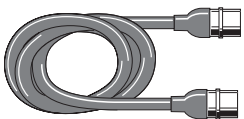

**Push-on Cable\*** attaches to the round antenna connectors (called 75-ohm F-type) on the back of your VCR or TV. The ends push on for a quick connection. VH89 (6-ft)

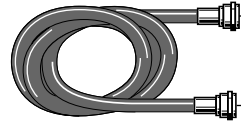

**Screw-on Cable\*** attaches to the round antenna connectors (called 75-ohm F-type) on the back of your VCR or TV. The ends screw onto the connectors for a secure connection. VH82 (6-ft), VH81 (3-ft)

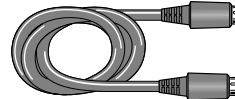

**S-Video Cable** has multi-pin connectors on each end for connecting S-Video components to your TV. VH976 (6-ft), VH913 (12-ft)

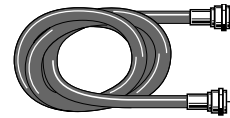

**RG-6 Coaxial Burial Cable** with weatherproof "F" connectors. D905

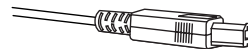

**Optical/SPDIF cables** help you connect to a component with an Optical Audio In jack, such as a Dolby Digital decoder or receiver. DV3 (3-ft), DV6 (6-ft)

\* This accessory is intended for use with an off-air or cable TV signal distribution and is not suitable for distribution of the satellite signal originating from your satellite dish antenna.

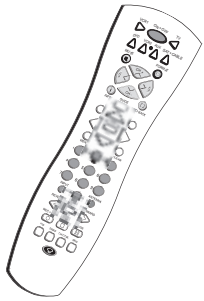

RCR160TBLM1

**Remote Control** This is the remote control that came packed with your TV. Replacements or spares can be ordered as needed.

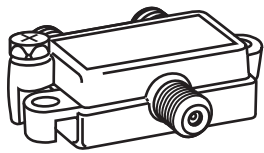

2-way Splitter (VH47)  
4-way Splitter (VH49)

**2-way Signal Splitter, 4-way Signal Splitter\*** helps you connect to other components.



ANT200

**Amplified VHF/UHF/FM Antenna** allows you to easily switch from the antenna signal to cable or satellite easily without disconnecting antenna.

## Accessory Order Form

Description	Part No.	Price	Qty	Total
Screw-on antenna cable* (3-ft)	VH81	\$3.95		
Screw-on antenna cable* (6-ft)	VH82	\$4.95		
Push-on antenna cable* (6-ft)	VH89	\$5.95		
Weatherproof "F" Connector (2)	D905	\$5.95		
Monaural VCR Dubbing Cable (6-ft)	VH83	\$5.95		
Stereo VCR Dubbing Cable (6-ft)	VH84	\$9.95		
S-Video Cable (6-ft)	VH976	\$7.95		
S-Video Cable (12-ft)	VH913	\$14.95		
2-way Signal Splitter*	VH47	\$3.95		
4-way Signal Splitter*	VH49	\$6.95		
Amplified Antenna	ANT200	\$49.95		
Antenna Mixer	193984	\$11.15		
Remote Control (RCR160TBLM1)	257076	\$24.00		
Optical/SPDIF Cable (3-ft)	DV3	\$15.95		
Optical/SPDIF Cable (6-ft)	DV6	\$19.95		
Audio•Video Adapter	228449	\$4.45		
Diplexer	D920	\$19.95		

Total Merchandise .....	\$
Sales Tax .....	\$
We are required by law to collect the appropriate sales tax for each individual state, country, and locality to which the merchandise is being sent.	
Shipping and Handling* .....	\$ 5.00
Total Amount Enclosed .....	\$
Use VISA, MasterCard, or Discover Card preferably. Money order or check must be in U.S. currency only. No COD or CASH.	



Detach Here

Prices are subject to change without notice.

All accessories are subject to availability.

Where applicable, we will ship a superseding model.

Please complete other side also

\* This accessory is intended for use with an off-air or cable TV signal distribution and is not suitable for distribution of the satellite signal originating from your satellite dish antenna.

Charge your order on your VISA, MasterCard, or Discover Card by filling in below

**USE YOUR CREDIT CARD**

**IMPORTANT:** Copy complete account number from your VISA card



My card expires:

**IMPORTANT:** Copy complete account number from your MasterCard



Copy Number above your name on MasterCard  My card expires:

**IMPORTANT:** Copy complete account number from your Discover Card



My card expires:

---

**AUTHORIZED SIGNATURE**  
(Credit card order will not be processed without signature)

Print or type your name and address clearly.



A complete and correct order will save you days of waiting.

Name: \_\_\_\_\_

Street: \_\_\_\_\_

\_\_\_\_\_ Apt: \_\_\_\_\_

City: \_\_\_\_\_

State: \_\_\_\_\_ Zip: \_\_\_\_\_

Daytime Phone Number: \_\_\_\_\_

Please make sure that both sides of this form have been filled out completely.

- Allow 4 weeks for delivery.
- All accessories are subject to availability.
- Prices are subject to change.

## Placing an Order

To place your order by phone, have your Visa, MasterCard or Discover Card ready and call the toll-free number listed below.

Use this number only to place an order for accessory items listed on this order form.

**1-800-338-0376**

To place your order by mail, detach and mail the completed order form with credit card information, money order or check in US currency (made payable to Thomson Consumer Electronics, Inc.) to the following address:

**Video Accessories**  
**PO Box 8419**  
**Ronks, PA 17573**

## Limited Warranty

### What your warranty covers:

- Defects in materials or workmanship.

### For how long after your purchase:

- One year from date of purchase for labor.
- One year from date of purchase for parts.
- Two years from date of purchase for the picture tube.

The warranty period for rental units begins with the first rental or 45 days from date of shipment to the rental firm, whichever comes first.

### What we will do:

- Pay an Authorized Service Center the labor charges to repair your unit.
- Pay an Authorized Service Center for the new, or at our option, refurbished replacement parts and picture tube required to repair your unit.

### How you get service:

- Call 1-866-SCENIUM and have your unit's date of purchase and model/serial number ready.
- A representative will troubleshoot your problem over the phone.
- If the representative determines that you should receive service, they will provide you with the name(s) of the Authorized Service Center in your area.
- Contact the Service Center and arrange for home or pick up, repair, and return service, provided that your unit is located within the geographic territory covered by an Authorized Service Center. If not, you must take your unit to the Service Center location at your own expense, or pay for the cost the Service Center may charge to transport your unit to and from your home.
- Proof of purchase in the form of a bill of sale or receipted invoice which is evidence that the product is within the warranty period must be presented to obtain warranty service. For rental firms, proof of first rental is also required.

### What your warranty does not cover:

- Customer instruction. (Your Owner's Manual describes how to install, adjust, and operate your unit. Any additional information should be obtained from your dealer.)
- Installation and related adjustments.
- Damage resulting from non-approved installation methods.
- Signal reception problems not caused by your unit.
- Damage from misuse or neglect.
- Batteries.
- Images burnt onto the screen.
- A television that has been modified or incorporated into other products, or is used for institutional or other commercial purposes.
- A unit purchased or serviced outside the U.S.A.
- Acts of nature, such as but not limited to lightning damage.

### Product Registration:

- Please complete and mail the Product Registration Card packed with your unit. It will make it easier to contact you should it ever be necessary. The return of the card is not required for warranty coverage.

## Limitation of Warranty:

- **THE WARRANTY STATED ABOVE IS THE ONLY WARRANTY APPLICABLE TO THIS PRODUCT. ALL OTHER WARRANTIES, EXPRESS OR IMPLIED (INCLUDING ALL IMPLIED WARRANTIES OF MERCHANTABILITY OR FITNESS FOR A PARTICULAR PURPOSE) ARE HEREBY DISCLAIMED. NO VERBAL OR WRITTEN INFORMATION GIVEN BY THOMSON MULTIMEDIA INC., ITS AGENTS OR EMPLOYEES SHALL CREATE A WARRANTY OR IN ANY WAY INCREASE THE SCOPE OF THIS WARRANTY.**
- **REPAIR OR REPLACEMENT AS PROVIDED UNDER THIS WARRANTY IS THE EXCLUSIVE REMEDY OF THE CONSUMER. THOMSON MULTIMEDIA INC. SHALL NOT BE LIABLE FOR INCIDENTAL OR CONSEQUENTIAL DAMAGES RESULTING FROM THE USE OF THIS PRODUCT OR ARISING OUT OF ANY BREACH OF ANY EXPRESS OR IMPLIED WARRANTY ON THIS PRODUCT. THIS DISCLAIMER OF WARRANTIES AND LIMITED WARRANTY ARE GOVERNED BY THE LAWS OF THE STATE OF INDIANA. EXCEPT TO THE EXTENT PROHIBITED BY APPLICABLE LAW, ANY IMPLIED WARRANTY OF MERCHANTABILITY OR FITNESS FOR A PARTICULAR PURPOSE ON THIS PRODUCT IS LIMITED TO THE APPLICABLE WARRANTY PERIOD SET FORTH ABOVE.**

## How State Law relates to warranty:

- Some states do not allow the exclusion nor limitation of incidental or consequential damages, or limitations on how long an implied warranty lasts, so the above limitations or exclusions may not apply to you.
- This warranty gives you specific legal rights, and you also may have other rights that vary from state to state.

## If you purchased your unit outside the United States:

- This warranty does not apply. Contact your dealer for warranty information.

**Service calls which do not involve defective materials or workmanship are not covered by this warranty. Costs of such service calls are the sole responsibility of the purchaser.**

## Care and Cleaning

CAUTION: Turn OFF your TV before cleaning.

You can clean the TV as required, using a soft lint-free cloth. Be sure to occasionally dust the ventilation slots in the cabinet to help assure adequate ventilation.

The TV's screen may be cleaned with a soft, lint-free cloth as well. Take care not to scratch or mar the screen. If necessary, you may use a cloth dampened with warm water.

Never use strong cleaning agents, such as ammonia-based cleaners, or abrasive powder. These types of cleaners will damage the TV.

While cleaning do not spray liquid directly on the screen, or allow liquid to run down the screen and inside the TV. Also, avoid placing drinks or vases with water on top of the TV. This could increase the risk of fire or shock hazard or damage to the TV.



# Index

## Symbols

1394 1  
16:9 icon 34  
16:9 widescreen 2

## A

A/V receiver connection 10  
Accessories 74  
Action buttons 26, 53  
    GUIDE Plus+ system 37  
Age-based rating  
    Blocking 43  
    Viewing 43  
Age-Based Ratings 42  
Amplifier 6  
Analog captions 63  
Analog TV channel 35  
ANTENNA A 8, 9, 13  
ANTENNA A INPUT 16  
ANTENNA B 8, 9, 13, 16  
ANTENNA button 26  
*Antenna Info* 59  
Arrow buttons 26, 47  
Assisted setup 19, 20  
AUDIO  
    L/MONO 15  
Audio codes 32  
Audio format icon 34  
AUDIO INPUT 3/  
    VIDEO INPUT 3 15  
AUDIO INPUT 5 /  
    VIDEO INPUT 5 16  
AUDIO INPUT1/  
    VIDEO INPUT 1 15  
Audio language 57  
Audio menu 56  
AUDIO OUTPUT  
    Digital 16  
Audio processor 57  
Audio receiver 6  
Audio/video cables 7  
Auto  
    Channel search 20  
Auto color 54, 55  
Auto converge 55  
Auto tuning 2, 46, 61

Automatic code search 29  
Autotuning  
    Front Input 46  
AUX button 26, 31

## B

Back of the TV 14  
Back panel 14  
Backlight button 26  
Balance 58  
Batteries 19  
Black Level 54  
Block  
    Age-Based Ratings 43  
    Front Panel 45  
    Movie ratings 44  
    Specific Content Themes 43  
    V-Chip Unrated Program 45  
    Web browser 45  
Blue action button 26  
Blue centering 55  
Browser  
    Web 49  
Browser, Web 1, 48  
Buttons  
    ANTENNA 26  
    Arrows 26, 47  
    AUX 26, 31  
    Backlight 26  
    Blue action 26  
    CH CTRL 26  
    CH ctrl 47  
    Channel down 18, 26  
    Channel up 18, 26  
    CLEAR 26  
    Don't work 68  
    DVD 26  
    FORMAT 26, 48  
    FORWARD 27  
    Front panel 18  
    GO BACK 27  
    Green action 26  
    GUIDE 27  
    INFO 18, 27  
    INPUT 18, 27, 30  
    MENU 18, 27

Number 26  
OK 18, 27  
PAUSE 27  
PIP 27, 47  
PLAY 27  
POWER 18  
REC VCR + 27  
Remote control 26  
REVERSE 27, 28  
SAT CABLE 27, 31  
STOP 27  
SWAP 27, 47  
TV 27  
VCR1 27  
VCR2 27  
Volume down 18  
Volume up/down 27

## C

Cable box remote codes 31  
Cables 12, 74  
    Audio/video 7  
    audio/video 13  
    coaxial 7  
    COMPONENT VIDEO 13  
    for Y, Pb, Pr jacks 13  
    G-LINK 7  
    optical 12  
    S-Video 7, 13  
Caption display 62  
Caption priority 63  
Caption style 63  
Care and Cleaning 69  
Care and cleaning 78  
CENTER CHANNEL INPUT 15  
Center channel input 15  
Center speaker input 15  
CH CTRL button 26, 47  
Channel 3 46  
    Search 20  
Channel banner 34  
Channel down button 18  
Channel lists 40  
Channel search 20, 60  
Channel up button 18  
Channels  
    Digital or Analog 35  
Channels lists 39  
Chart, of connections 7  
Choice fields 53  
Choice lists 53  
Choose Your Connection 7  
Cleaning and care 78  
CLEAR button 26  
Closed captioning 34, 62, 63  
Coaxial cable 7  
Codes  
    Audio 32  
    Cable box 31  
    DVD 32  
    Satellite receiver 32  
    VCR 31  
Color 54  
    Warmth 55  
Color scheme 65  
Color warmth 54  
Component Video cables 7  
Components, connecting 7  
Composite jacks 13  
Connection  
    A/V Receiver + Speakers 10  
    DVD player, TV, VCR 8  
    Illustrations 6  
    Satellite Receiver, TV, VCR 9  
    Speakers & A/V receiver 10  
    TV, Satellite Receiver, VCR 9  
    TV, VCR, DVD Player 8  
    VCR, TV, DVD player 8  
    VCR, TV, Satellite Receiver 9  
Connections  
    Menu 59  
Content Themes 42  
    Viewing 44  
Content themes  
    Blocking 43  
Contrast 54

Control panel  
  Actions buttons 53  
Control panels 52  
  Choice fields 53  
  Choice lists 53  
  Menu buttons 53  
  Numeric entries 53  
  Sliders 53  
Convergence 54, 55

## D

Digit buttons 26  
Digital audio out 59  
DIGITAL AUDIO OUT jack  
  10, 12, 16  
Digital channel info 66  
Digital TV channel 35  
Dimensions 73  
Direct entry 28  
Dolby Digital receiver 12  
DTVLink 1  
DVD button 26  
DVD codes 32  
DVD player, VCR, TV  
  Connection 8

## E

Ethernet 16  
Ethernet jack 12  
Ethernet setup 62  
Exiting a menu 52  
EXT / INT w/EXT SURR  
  switch 10  
External speakers 14

## F

Favorite URLs 49  
Finding the sensor 17  
FireWire 1  
Fixed output 10  
FIXED/VARIABLE AUDIO  
  OUTPUT L/R 14  
Fixed/variable out 58  
Format  
  Screen 64  
FORMAT button 26, 48  
FORWARD button 27

Front  
  And rear speaker jacks  
  15  
Front Panel  
  Inputs 18  
Front panel  
  Buttons 18  
Front panel block 45

## G

G-LINK 16  
  cable 7  
  connecting 17  
GO BACK button 27  
Graphic equalizer 56  
Green action button 26  
GUIDE button 27  
GUIDE Plus+ system 36  
  Action buttons 37  
  Blue action button 26  
  Channels 39  
  Expanded information  
  37  
  Green action button 26  
  Listings 37  
  Lock/Unlock 38  
  Messages 39  
  News 38  
  Promotions 39  
  Promotions & Advertis-  
  ing 39  
  Schedule 38  
  Setup 20, 39  
  Sort 38  
Guide Plus+ system 20, 24

## H

Help text 2, 52

## I

Indicator, remote control  
  27  
Indirect light 6  
INFO button 18, 27  
INPUT  
  2 jacks 15, 16  
  3 jacks 15

Button 30  
Input  
  ANTENNA A 16  
  Center channel 15  
INPUT button 18, 27, 54  
Inputs  
  Front panel 18  
INT W/EXT SURR / EXT 10  
Internal speakers 10, 11

## J

Jack  
  Ethernet 12  
Jacks 12, 14  
  audio/video 13  
  Composite video 13  
  Record output 2  
  RF 13  
  S-VIDEO 13

## K

Key Features Overview 1

## L

Language  
  Audio 57  
  Menu 20, 65  
Languages, selecting 20  
LED, front panel 19, 68  
Limited warranty 77  
Listings, GUIDE Plus+  
  system 37  
Locating remote sensor 17

## M

Main Menu 52  
Menu  
  Audio 56  
  Connections 59  
  Exiting 52  
  Picture Quality 54  
  Preferences 62  
  Time 59  
MENU button 18, 27, 52  
Menu buttons 53  
Menu language 20, 65

Menus 52  
  GUIDE Plus+ system 36  
  GUIDE Plus+ System  
  setup 20  
Messages menu 39  
Modes, remote control 29  
Mono 57  
Mute button 27

## N

News menu 38  
Noise filter 54, 55  
Normal 64  
Number buttons 26  
Numeric entries 53

## O

OK button 18, 27  
On-screen help 52  
On-screen help text 2, 52  
On-screen Program Guide  
  1  
One touch recording 1  
Optical cable 12  
Order form  
  Accessory 75  
Output  
  RECORD 16  
OUTPUTS  
  Audio 14

## P

Parental controls 1, 40  
  Channel lists 40  
  Editing 41  
  Editing channels 41  
  Lock/unlock 40  
Parental controls icon 34  
PAUSE button 27  
Picture Presets 54  
Picture quality menu 54  
Picture settings 54  
PIP  
  Channel control 26  
  PIP (Picture in Picture)  
  Buttons 47  
  Problems 48

- PIP button 27, 47
  - PIP, using 47
  - PLAY button 27, 29
  - POWER button 18
  - Power surges 6
  - Preferences menu 62
  - Problems
    - GUIDE Plus+ system 69
    - Parental controls 71
    - Remote control 70
    - TV 68
    - V-Chip 71
  - Program Guide, On-screen 1
  - Programming
    - Cable box codes 31
    - DVD codes 32
    - Satellite receiver codes 32
    - VCR codes 31
  - Programming codes
    - Audio 32
  - Programming the remote
    - Automatic code search 28
    - Direct entry 28
  - Promotions, GUIDE Plus+ system 39
  - Pulse code modulation 59
- Q**
- Quick Search 60
- R**
- Rating Limits
    - movies 44
    - TV 41
  - Ratings
    - Blocking movie 44
    - Viewing movie 44
  - RCA-type cables 13
  - REC VCR+ button 27
  - RECORD OUTPUT 16
  - Record Output 65
  - Record output jacks 2
  - Recording
    - One touch 1
  - Red centering 55
  - Remote
    - Programming 28
    - sensor 17
  - Remote Control
    - Buttons 26
    - Installing the Batteries 19
  - Remote control
    - Indicator 27
    - Programming codes 31
  - Reset controls 54, 56
  - REVERSE button 27, 29
  - RF jacks
    - Cables 13
- S**
- S-VIDEO 13
    - cable 7
  - SAP 34, 58
  - SAT CABLE
    - Button 27, 31
  - Satellite receiver codes 32
  - Satellite receiver connection 9
  - Scan velocity modulation 56
  - Schedule menu 38
  - Screen, Format 64
  - Search
    - Automatic code 29
    - Channel 20, 60
    - Full 20, 60
    - Quick 60
  - Second audio program 58
  - Setup
    - Ethernet 62
    - GUIDE Plus+ system menus 20
  - Setup, assisted 19
  - Setup menu 39
  - Sharpness 54
  - Signal source 60
  - Signal type 61
  - SKIP button 27, 34
  - Sliders 53
  - Software ungrade 60
  - Sort menu, GUIDE Plus+ system 38
  - Sound logic 57
  - Speaker
    - Center input 15
  - SPEAKER SELECT
    - EXT. or INT W/EXT SURR switch 14
  - Speakers connection 10
  - Speakers, internal 10
  - Special features 61
  - Specifications 72
    - Back panel 73
    - Convenience 72
    - Front panel 73
    - Sound 72
    - Video 72
  - Specifications
    - General 73
  - Stereo 57
  - STOP button 27
  - Stretch 64
  - Subchannels 60
  - Subwoofer 59
  - SVM 54, 56
  - SWAP button 27, 47
- T**
- Things to Consider Before You Connect 6
  - Time menu 59
  - Tint 54
  - Translucency 65
  - Troubleshooting 68
  - Turn on TV 19
  - TV button 27
  - TV connection 9
  - TV mode 19
  - TV problems 68
  - TV, VCR, DVD Player Connection 8
- U**
- Universal remote
    - programming to control other brands of components 29
  - URLs 49
- V**
- V-Chip 40
    - Age-Based Ratings 41
    - Blocking age-based 43
    - Blocking Movies 44
    - Content Themes 41
    - TV ratings 41
  - Viewing age-based rating 43
  - V-Chip unrated program 45
  - V-Chip: Parental Controls 1
  - Variable Output 10
  - Variable/Fixed out 58
  - VCR
    - Guide Plus+ system 22
  - VCR codes 31
  - VCR connection 9
  - VCR1 button 27
  - VCR2 button 27
  - VIDEO 15
  - Video
    - Games 16
  - VIDEO INPUT 2 / AUDIO INPUT 2 15
  - VIDEO INPUT 3 15
  - VIDEO INPUT1/AUDIO INPUT 1 15
  - VIDEO INPUT4/AUDIO INPUT 4 15
  - Viewing
    - Movie ratings 44
    - Specific content themes 44
  - Volume down button 18
  - Volume up button 18
  - Volume up/down buttons 27
- W**
- Warranty, limited 77
  - Web browser 1, 49
    - Screen burn prevention 49
  - Web browser block 45
  - Web browser, controlling 49
  - Web browser, using 48
- Y**
- Y Pb Pr jacks 13
- Z**
- Zoom 64

**Visit the RCA website at [www.rca.com](http://www.rca.com)**

---

Please do not send any products to the Indianapolis address listed in this manual or on the carton. This will only add delays in service for your product.

**Thomson multimedia Inc.  
10330 North Meridian Street  
Indianapolis, IN 46290**

©2002 Thomson multimedia Inc.  
Trademark(s)® Registered  
Marca(s) Registrada(s)  
Printed in USA  
**TOCOM 15876330 REV 1**



## Free Manuals Download Website

<http://myh66.com>

<http://usermanuals.us>

<http://www.somanuals.com>

<http://www.4manuals.cc>

<http://www.manual-lib.com>

<http://www.404manual.com>

<http://www.luxmanual.com>

<http://aubethermostatmanual.com>

Golf course search by state

<http://golfingnear.com>

Email search by domain

<http://emailbydomain.com>

Auto manuals search

<http://auto.somanuals.com>

TV manuals search

<http://tv.somanuals.com>