

RCA

LCD Television User's Guide





Commercial Television

J22C760 J26C700
J32C750 J42C750

Changing Entertainment. Again.



Important Information

 CAUTION RISK OF ELECTRIC SHOCK DO NOT OPEN		 The lightning flash with arrowhead symbol, within an equilateral triangle, is intended to alert the user to the presence of uninsulated "dangerous voltage" within the product's enclosure that may be of sufficient magnitude to constitute a risk of electric shock to persons.
CAUTION: TO REDUCE THE RISK OF ELECTRIC SHOCK DO NOT REMOVE COVER (OR BACK). NO USER SERVICEABLE PARTS INSIDE. REFER TO QUALIFIED SERVICE PERSONNEL.		The exclamation point within an equilateral triangle is intended to alert the user to the presence of important operating and maintenance (servicing) instructions in the literature accompanying the appliance.

WARNING

TO PREVENT FIRE OR SHOCK HAZARDS, DO NOT EXPOSE THIS PRODUCT TO RAIN OR MOISTURE.

Product Registration

Please fill out the product registration card (packed separately) and return it immediately. For US customers: Your RCA Consumer Electronics product may also be registered at <http://service.rcacommercialtv.com>. Registering this product allows us to contact you if needed.

Product Information

Keep your sales receipt to obtain warranty parts and service and for proof of purchase. Attach it here and record the serial and model numbers in case you need them. These numbers are located on the product.

Model No. _____

Serial No. _____

Purchase Date: _____

Dealer/Address/Phone: _____

NOTE TO CABLE TV INSTALLER

This reminder is provided to call the CATV system installer's attention to Article 820-40 of the National Electric Code (U.S.A.). The code provides guidelines for proper grounding and, in particular, specifies that the cable ground shall be connected to the grounding system of the building, as close to the point of the cable entry as practical.

Important Information

CAUTION

Do not attempt to modify this product in any way without written authorization from RCA. Unauthorized modification could void the user's authority to operate this product.

CAUTION

THESE SERVICING INSTRUCTIONS ARE FOR USE BY QUALIFIED SERVICE PERSONNEL ONLY. TO REDUCE THE RISK OF ELECTRIC SHOCK, DO NOT PERFORM ANY SERVICING OTHER THAN THAT CONTAINED IN THE OPERATING INSTRUCTIONS UNLESS YOU ARE QUALIFIED TO DO SO.

WARNING

Apparatus shall not be exposed to dripping or splashing and no objects filled with liquids, such as vases, shall not be placed on the apparatus.

CAUTION

When used outside of U.S., other power supply cords may be used if the cord is approved by the local regulating agency.

CLEANING AND DISINFECTION

Clean the exterior of this television by removing dust with a lint-free cloth.

CAUTION: To avoid damage to the surface of the television, do not use abrasive or chemical cleaning agents.

This apparatus with class I construction shall be connected to a main socket outlet with a protective earthing connection.

Important Information

DISCONNECTING DEVICE FROM MAINS

Main plug is the disconnecting device. The plug must remain readily operable.

IMPORTANT SAFEGUARDS FOR YOU AND YOUR NEW PRODUCT

YOUR PRODUCT HAS BEEN MANUFACTURED AND TESTED WITH YOUR SAFETY IN MIND. HOWEVER, IMPROPER USE CAN RESULT IN POTENTIAL ELECTRICAL SHOCK OR FIRE HAZARDS. TO AVOID DEFEATING THE SAFEGUARDS THAT HAVE BEEN BUILT INTO YOUR NEW PRODUCT, PLEASE READ AND OBSERVE THE FOLLOWING SAFETY POINTS WHEN INSTALLING AND USING YOUR NEW PRODUCT, AND SAVE THEM FOR FUTURE REFERENCE. OBSERVING THE SIMPLE PRECAUTIONS DISCUSSED IN THIS MANUAL CAN HELP YOU GET MANY YEARS OF ENJOYMENT AND SAFE OPERATION THAT ARE BUILT INTO YOUR NEW PRODUCT.

Note

- If the TV feels cold to the touch, there may be a small "flicker" when it is turned on. This is normal, there is nothing wrong with the TV.
- Some minute dot defects may be visible on the screen, appearing as tiny red, green, or blue spots. However, they have no adverse effect on the TV's performance.
- Avoid touching the LCD screen or holding your finger(s) against it for long periods of time. Doing so may produce some temporary distortion effects on the screen.

REGULATORY INFORMATION

This equipment has been tested and found to comply with the limits for a Class B digital device, pursuant to Part 15 of the FCC Rules.

These limits are designed to provide reasonable protection against harmful interference when the equipment is operated in a residential installation.

This equipment generates, uses and can radiate radio frequency energy and, if not installed and used in accordance with the instruction manual, may cause harmful interference to radio communications.

However, there is no guarantee that interference will not occur in a particular installation.

If this equipment does cause harmful interference to radio or television reception, which can be determined by turning the equipment off and on, the user is encouraged to try to correct the interference by one or more of the following measures:

- Reorient or relocate the receiving antenna.
- Increase the separation between the equipment and receiver.
- Connect the equipment into an outlet on a circuit different from that to which the receiver is connected.
- Consult the dealer or an experienced radio/TV technician for help.

CAUTION

Changes or modifications not expressly approved by the party responsible for compliance could void the user's authority to operate the equipment.

THE PARTY RESPONSIBLE FOR PRODUCT COMPLIANCE
(RCA Commercial Electronics)
(TELEPHONE NO : 800-RCA-2161)

IMPORTANT SAFETY INSTRUCTIONS

Read before operating equipment

1. Read these instructions.
2. Keep these instructions.
3. Heed all warnings.
4. Follow all instructions.
5. Do not use this apparatus near water.
6. Clean only with dry cloth.
7. Do not block any ventilation openings. Install in accordance with the manufacturer's instructions.
8. Do not install near any heat sources such as radiators, heat registers, stoves, or other apparatus (including amplifiers) that produce heat.
9. Do not defeat the safety purpose of the polarized or grounding-type plug. A polarized plug has two blades with one wider than the other. A grounding type plug has two blades and a third grounding prong. The wide blade or the third prong is provided for your safety. If the provided plug does not fit into your outlet, consult an electrician for replacement of the obsolete outlet.
10. Protect the power cord from being walked on or pinched particularly at plugs, convenience receptacles, and the point where they exit from the apparatus.
11. Only use attachments/accessories specified by the manufacturer.
12. Use only with the cart, stand, tripod, bracket, or table specified by the manufacturer, or sold with the apparatus. When a cart is used, use caution when moving the cart/apparatus combination to avoid injury from tip-over.
13. Unplug this apparatus during lightning storms or when unused for long periods of time.
14. Refer all servicing to qualified service personnel. Servicing is required when the apparatus has been damaged in any way, such as powersupply cord or plug is damaged, liquid has been spilled or objects have fallen into the apparatus, the apparatus has been exposed to rain or moisture, does not operate normally, or has been dropped.
15. If an outside antenna or cable system is connected to the product, be sure the antenna or cable system is grounded so as to provide some protection against voltage surges and built-up static charges. Section 810 of the National Electrical Code, ANSI/NFPA No. 70-1984 (Section 54 of Canadian Electrical Code, Part 1) provides information with respect to proper grounding of the mast and supporting structure, grounding of the lead-in wire to an antenna-discharge unit, size of grounding conductors, location of antenna-discharge unit, connection to grounding electrodes, and requirements for the grounding electrode. See following example.

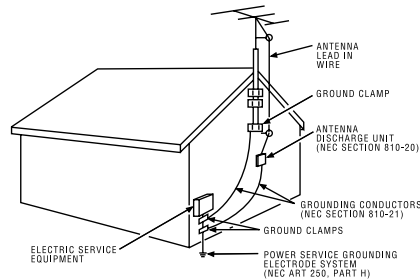

Note

- The lamp in this product contains mercury. Please dispose of in accordance with local, state, or federal laws.

Table of Contents

Important Information	2	On Screen Menus	45
IMPORTANT SAFETY INSTRUCTIONS	5	Setting up the TV Channel	46
Chapter 1: Connections and Setup		Auto Scan	46
Things to Consider Before You Connect	7	Add / Delete a Channel.....	47
Protect Against Power Surges	7	Picture Controls	48
Protect Devices from Overheating.....	7	Adjusting The Picture Controls	48
Position Cables Properly to Avoid Audio		Manual Picture Controls	49
Interference	7	Gamma.....	50
Use Indirect Light	7	Color Temperature	51
Remote Control	7	Reset Picture Mode	52
Check Supplied Parts.....	7	Advanced Video	53
Controls And Connectors	8	Dynamic Noise Reduction	53
Front Panel - J22C760	8	CTI (Color Transient Intensity)	54
Rear Panel - J22C760	9	Flesh Tone	54
Front Panel - J26C700	10	Adaptive Luma Control.....	55
Rear Panel - J26C700.....	11	Blue Mute	55
Front Panel - J32C750	12	Back Light	56
Rear Panel - J32C750.....	13	Screen Mode	57
Front Panel - J42C750	14	Sound Controls	58
Rear Panel - J42C750.....	15	Adjusting The Sound Controls	58
Connections	16	Manual Sound Controls	59
Wall mount Installation	16	Sound Surround	60
Desktop Pedestal Installation.....	16	Equalizer	60
Parts for stand assembly.....	17	Digital Output	61
Stand Installation	19	Stereo/SAP Broadcast Setup	62
Antenna Connection.....	22	Audio Language	62
VCR Connection.....	23	Time Setting	63
DVD Connection	25	Time Zone Settings	63
HDSTB Connection	26	Auto Time Settings	64
External A/V Source.....	29	Manual Time Settings	65
Digital Audio Out	30	Auto On /Off Time Settings	66
PC Connection	31	Sleep Timer	67
Resolution	33	Captions	68
USB in Setup	33	Closed Caption - Analog.....	68
Chapter 2: Using the Remote Control		Closed Caption - Digital	69
Basic(User) Remote	34	Digital Closed Caption Options	70
Master(Installer) Remote	35	Reset	71
Put Batteries in the Remote	35	Reset Default	71
Chapter 3: Using USB Clone Tool		Parental Control	72
USB Cloner Out-looking	36	Entering your password	72
Errors Table	36	Set Password	72
Learning Connection	37	Ratings - Enable / Disable	73
Teaching Connection.....	39	TV Ratings for USA	74
Chapter 4: Basic Operation		Movie Ratings	76
Plug in the TV	40	English TV Ratings for Canada	77
Turn on the TV.....	40	French TV Ratings for Canada	78
Channel Scan	40	Downloadable Rating	79
Channel Selection	40	Block Unrated	80
Volume Adjustment	40	Clean All.....	80
Sound Mute	40	Setting the PC Mode.....	81
Source Selection	41	Automatic Screen Adjustment	81
Language Selection.....	41	Manual Screen Adjustment	82
Chapter 5: Commercial Interface Menus		USB Functions	83
Commercial Interface Menus	42	Picture Function	83
Chapter 6: Using the TV's Features		Music Function	84
		Specification	85
		Chapter 7: Other Information	
		Troubleshooting	89
		Limited Warranty	90
		Care and Cleaning	91
		CHILD SAFETY	92

Chapter 1: Connections and Setup

"User must use shielded signal interface cables with ferrite cores to maintain standard compliance for the product"

Things to Consider Before You Connect

Protect Against Power Surges

- Connect all devices before you plug any of their power cords into the wall outlet or power strip. NEVER plug your TV into an outlet that is controlled by a wall switch.
- Turn off the TV and/or device(s) before you connect or disconnect any cables.
- Make sure all antennas and cables are properly grounded. Refer to the Important Safety Instructions at the beginning of the User's Guide.

Protect Devices from Overheating

- Don't block ventilation holes on any of the devices. Arrange the devices so that air can circulate freely.
- Don't stack devices.
- If you place devices in a stand, make sure you allow adequate ventilation.
- If you connect an audio receiver or amplifier, place it on the top shelf so the heated air from it won't flow around other devices.

Position Cables Properly to Avoid Audio Interference

- Insert each cable firmly into the designated jack.
- If you place devices above the TV, route all cables down the side of the back of the TV instead of straight down the middle.
- If your antenna uses 300-ohm twin lead cables, do not coil the cables. Also, keep the twin lead cables away from audio/video cables.

Use Indirect Light

Don't place the TV where sunlight or room lighting will be directed toward the screen. Use soft or indirect lighting.

Remote Control

You will need a master remote or USB Cloner to set up the TV. Contact your RCA Commercial Distributor to purchase these.

Check Supplied Parts

Check that the following parts were packed with your product.

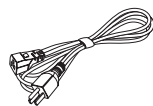

Power Cord

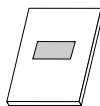

Owner's Manual



Stand Base
(Optional)



Stand Body
(Optional)

Note

- If you need to replace your remote, call 800-RCA-2161. A shipping and handling fee, and the appropriate sales tax, will be charged upon ordering. Have your Visa, MasterCard, or Discover Card ready.
- Stand Base, Stand Body images shown may differ from your TV.

Chapter 1: Connections and Setup

Front Panel - J22C760

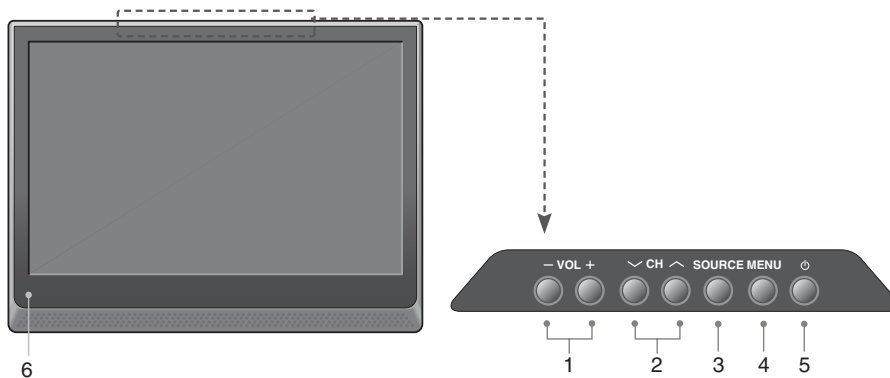

- 1. VOL- / VOL+**
Adjusts sound level and menu settings.
- 2. CH v / CH ^**
Select a channel.
- 3. SOURCE**
Selects the **TV**, **AV1**, **AV2**, **YPbPr**, **VGA**, **HDMI** or **USB** mode.
- 4. MENU**
Display on screen menus.
- 5. POWER**
Switches the set on or off.
- 6. Power Indicator**
Illuminates to bright blue when the TV is on. When the TV is powered off, this LED is also off.
Remote control sensor
Accepts the IR signal of remote controller.

Note

- Image shown may differ from your TV.

Chapter 1: Connections and Setup

Rear Panel - J22C760

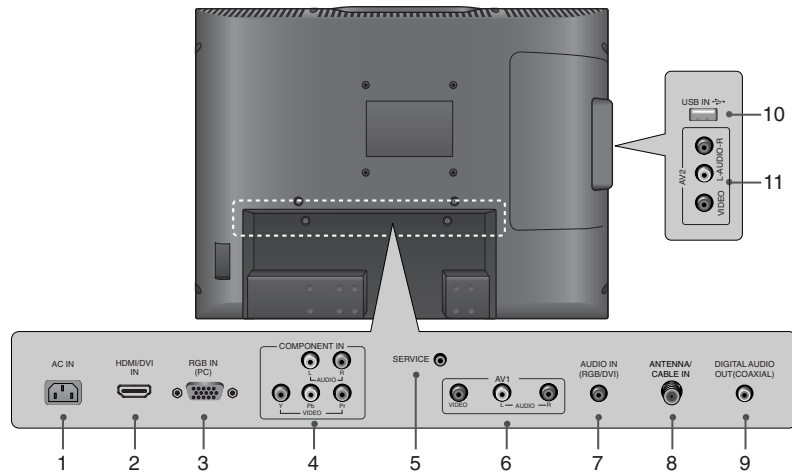

1. AC IN

This TV operates on AC power.

2. HDMI/DVI IN

Connect to the HDMI jack on devices with an HDMI output.
This input can also be used as a DVI connection with separate analog audio inputs.

3. RGB IN (PC)

Connect to the video output jack on your PC.

4. COMPONENT IN (YPbPr)

Video/Audio inputs for Component.

5. SERVICE

Used by clone device to learn settings in TV.

6. AV1

Connects to your Audio/Video devices using a composite (Yellow/Red/White) cable.

7. AUDIO IN (RGB/DVI)

Connect to the audio output jack on your PC.

8. ANTENNA/CABLE IN

Connect to your antenna or cable box for TV signal.

9. DIGITAL AUDIO OUT (COAXIAL)

Connect digital audio to various types of equipment.

10. USB IN

USB device interface.

11. AV2

Connects to your Audio/Video devices using a composite (Yellow/Red/White) cable.

Note

- Image shown may differ from your TV.

Chapter 1: Connections and Setup

Front Panel - J26C700

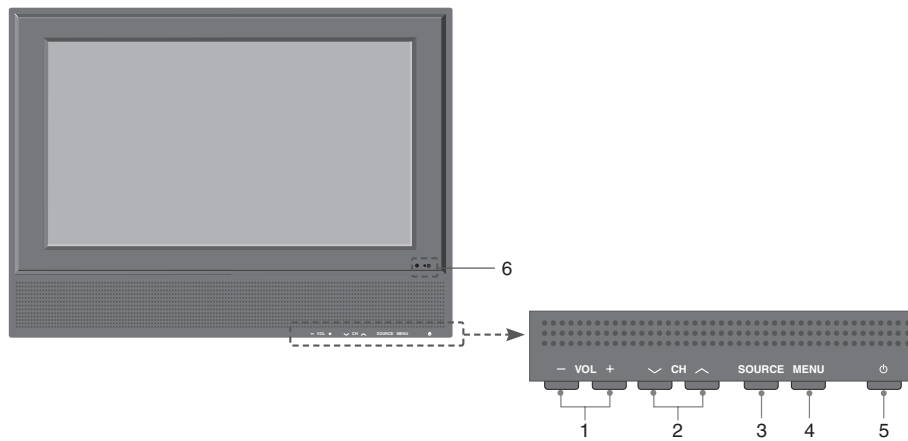

- 1. VOL- / VOL+**
Adjusts sound level and menu settings.
- 2. CH ∨ / CH ∧**
Select a channel.
- 3. SOURCE**
Selects the **TV**, **AV1**, **AV2**, **YPbPr**, **VGA**, **HDMI** or **USB** mode.
- 4. MENU**
Display on screen menus.
- 5. POWER**
Switches the set on or off.
- 6. Power Indicator**
Illuminates to bright blue when the TV is on. When the TV is powered off, this LED is also off.
Remote control sensor
Accepts the IR signal of remote controller.

Note

- Image shown may differ from your TV.

Chapter 1: Connections and Setup

Rear Panel - J26C700

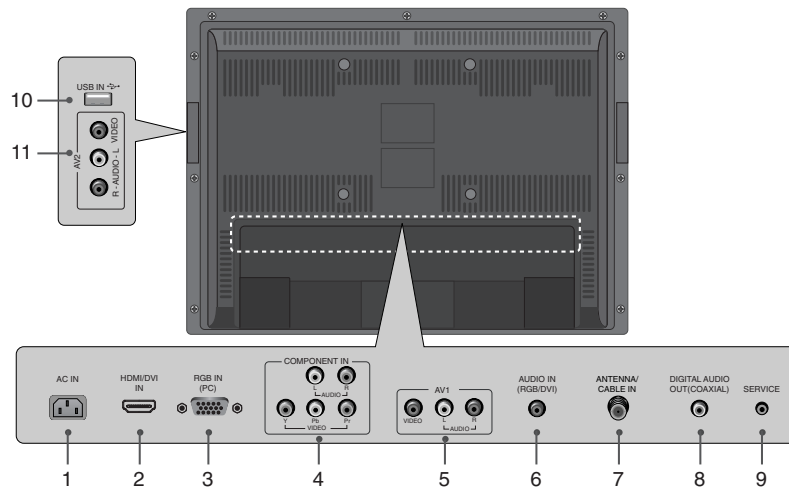

1. AC IN

This TV operates on AC power.

2. HDMI/DVI IN

Connect to the HDMI jack on devices with an HDMI output.
This input can also be used as a DVI connection with separate analog audio inputs.

3. RGB IN (PC)

Connect to the video output jack on your PC.

4. COMPONENT IN (YPbPr)

Video/Audio inputs for Component.

5. AV1

Connects to your Audio/Video devices using a composite (Yellow/Red/White) cable.

6. AUDIO IN (RGB/DVI)

Connect to the audio output jack on your PC.

7. ANTENNA/CABLE IN

Connect to your antenna or cable box for TV signal.

8. DIGITAL AUDIO OUT(COAXIAL)

Connect digital audio to various types of equipment.

9. SERVICE

Used by clone device to learn settings in TV.

10.USB IN

USB device interface.

11.AV2

Connects to your Audio/Video devices using a composite (Yellow/Red/White) cable.

Note

- Image shown may differ from your TV.

Chapter 1: Connections and Setup

Front Panel - J32C750

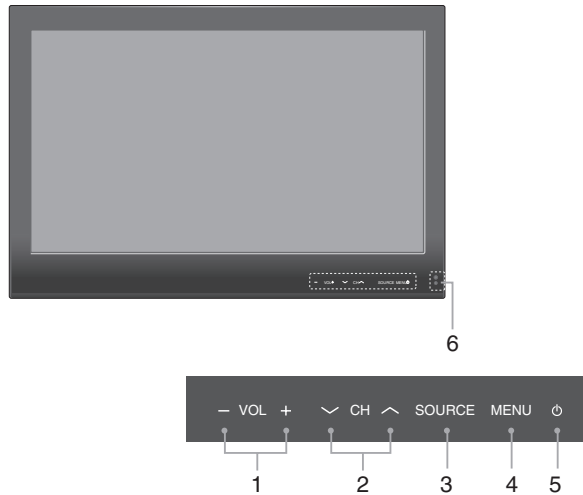

- 1. VOL- / VOL+**
Adjusts sound level and menu settings.
- 2. CH \downarrow / CH \uparrow**
Select a channel.
- 3. SOURCE**
Selects the **TV**, **AV1**, **AV2**, **YPbPr**, **VGA**, **HDMI** or **USB** mode.
- 4. MENU**
Display on screen menus.
- 5. POWER**
Switches the set on or off.
- 6. Power Indicator**
Illuminates to bright blue when the TV is on. When the TV is powered off, this LED is also off.
Remote control sensor
Accepts the IR signal of remote controller.

Note

- Image shown may differ from your TV.

Chapter 1: Connections and Setup

Rear Panel - J32C750

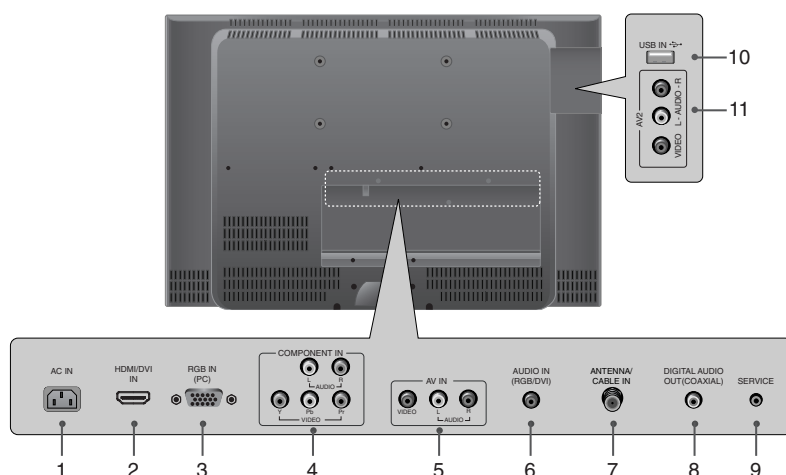

1. AC IN

This TV operates on AC power.

2. HDMI/DVI IN

Connect to the HDMI jack on devices with an HDMI output.
This input can also be used as a DVI connection with separate analog audio inputs.

3. RGB IN (PC)

Connect to the video output jack on your PC.

4. COMPONENT IN (YPbPr)

Video/Audio inputs for Component.

5. AV1

Connects to your Audio/Video devices using a composite (Yellow/Red/White) cable.

6. AUDIO IN (RGB/DVI)

Connect to the audio output jack on your PC.

7. ANTENNA/CABLE IN

Connect to your antenna or cable box for TV signal.

8. DIGITAL AUDIO OUT(COAXIAL)

Connect digital audio to various types of equipment.

9. SERVICE

Used by clone device to learn settings in TV.

10.USB IN

USB device interface.

11.AV2

Connects to your Audio/Video devices using a composite (Yellow/Red/White) cable.

Note

- Image shown may differ from your TV.

Chapter 1: Connections and Setup

Front Panel - J42C750

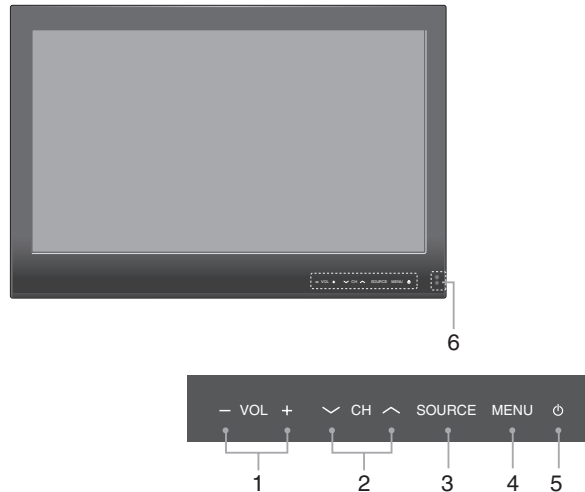

- 1. VOL- / VOL+**
Adjusts sound level and menu settings.
- 2. CH \downarrow / CH \uparrow**
Select a channel.
- 3. SOURCE**
Selects the **TV**, **AV1**, **AV2**, **YPbPr**, **VGA**, **HDMI** or **USB** mode.
- 4. MENU**
Display on screen menus.
- 5. POWER**
Switches the set on or off.
- 6. Power Indicator**
Illuminates to bright blue when the TV is on. When the TV is powered off, this LED is also off.
Remote control sensor
Accepts the IR signal of remote controller.

Note

- Image shown may differ from your TV.

Chapter 1: Connections and Setup

Rear Panel - J42C750

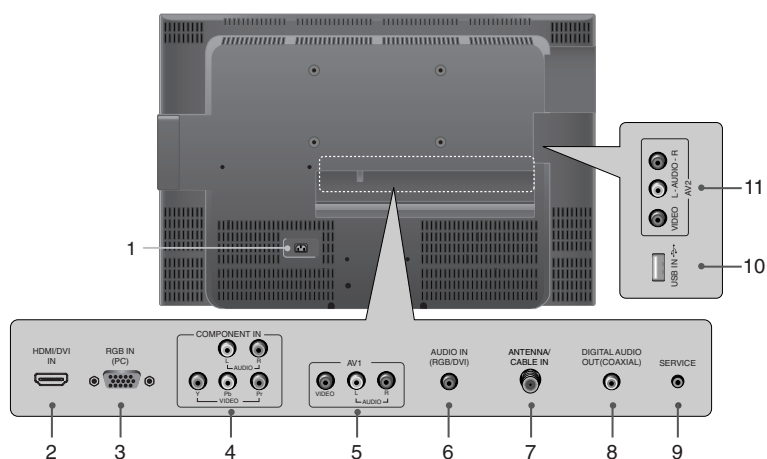

- 1. AC IN**
This TV operates on AC power.
- 2. HDMI/DVI IN**
Connect to the HDMI jack on devices with an HDMI output.
This input can also be used as a DVI connection with separate analog audio inputs.
- 3. RGB IN (PC)**
Connect to the video output jack on your PC.
- 4. COMPONENT IN (YPbPr)**
Video/Audio inputs for Component.
- 5. AV1**
Connects to your Audio/Video devices using a composite (Yellow/Red/White) cable.
- 6. AUDIO IN (RGB/DVI)**
Connect to the audio output jack on your PC.
- 7. ANTENNA/CABLE IN**
Connect to your antenna or cable box for TV signal.
- 8. DIGITAL AUDIO OUT(COAXIAL)**
Connect digital audio to various types of equipment.
- 9. SERVICE**
Used by clone device to learn settings in TV.
- 10. USB IN**
USB device interface.
- 11. AV2**
Connects to your Audio/Video devices using a composite (Yellow/Red/White) cable.

Note

- Image shown may differ from your TV.

Chapter 1: Connections and Setup

Wall mount Installation

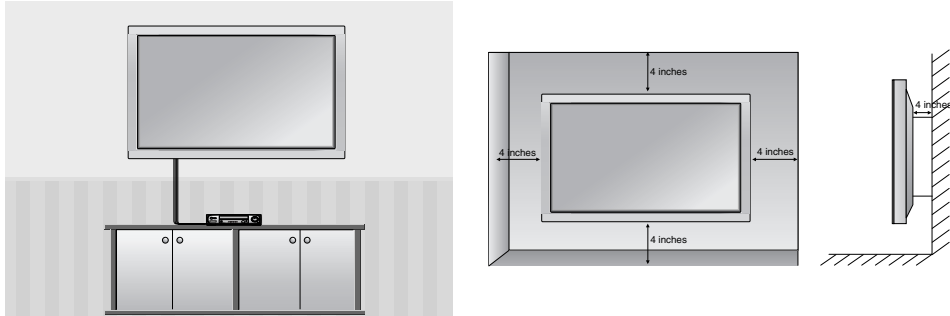

The set can be installed on a wall as shown above.
For proper ventilation, allow a clearance of 4 inches on all four sides from the wall.
Detailed instructions are available from your dealer, refer to the optional Wall Mounting Bracket Installation and Setup Guide. (Wall Mount Sold Separately)

Note

- This Television should be installed by a Qualified Service Personnel.

Desktop Pedestal Installation

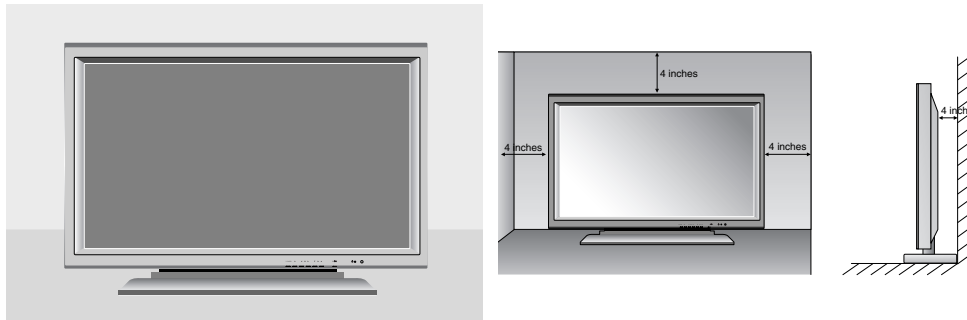

The set can be mounted on a desk as shown above.
For proper ventilation, allow a clearance of 4 inches on each side from the wall.
Detailed instructions are available from your dealer.

Note

- Image shown may differ from your TV.

Chapter 1: Connections and Setup

Parts for stand assembly - 22 inch

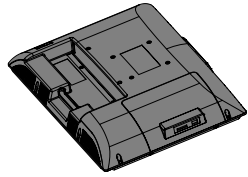

TV

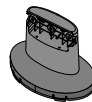

Stand Body

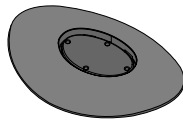

Stand Base

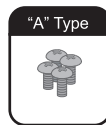

"A" Type

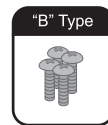

"B" Type

4 - A type bolts
4 - B type bolts

Parts for stand assembly - 26 inch

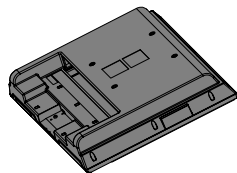

TV



Stand Body

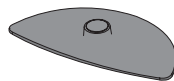

Stand Base

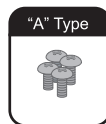

"A" Type

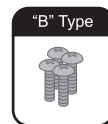

"B" Type

4 - A type bolts
4 - B type bolts

Chapter 1: Connections and Setup

Parts for stand assembly - 32/42 inches

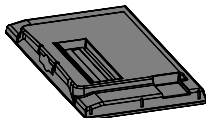

TV



Stand Body



Stand Base



4 - A type bolts
4 - B type bolts

Chapter 1: Connections and Setup

Stand Installation - 22 inch

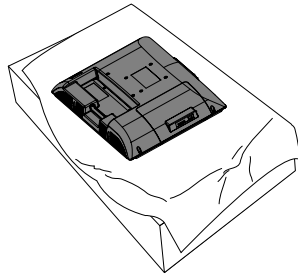

1. Carefully place the product screen side down on a cushioned surface that will protect the product and screen from damage.

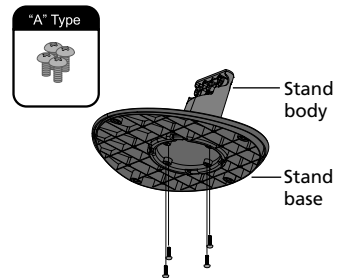

2. Using the screws provided assemble the stand body with the stand base as shown.

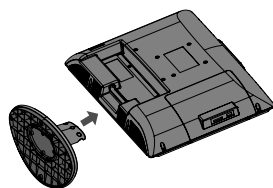

3. Assemble the product stand with the product as shown.

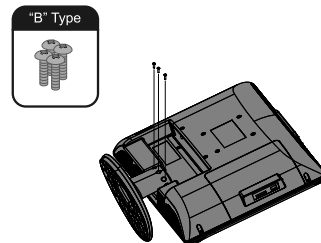

4. Install the 4 bolts securely, in the back of the product in the holes provided.

Note

- Image shown may differ from your TV.

Chapter 1: Connections and Setup

Stand Installation - 26 inch

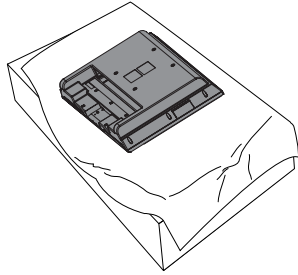

1. Carefully place the product screen side down on a cushioned surface that will protect the product and screen from damage.

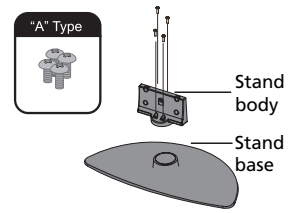

2. Using the screws provided assemble the stand body with the stand base as shown.

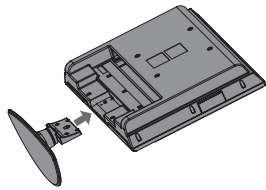

3. Assemble the product stand with the product as shown.

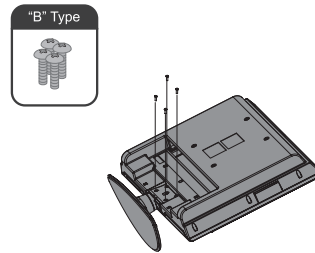

4. Install the 4 bolts securely, in the back of the product in the holes provided.

Note

- Image shown may differ from your TV.

Chapter 1: Connections and Setup

Stand Installation - 32/42 inches

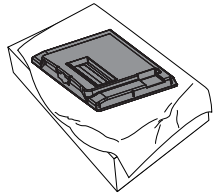

1. Carefully place the product screen side down on a cushioned surface that will protect the product and screen from damage.

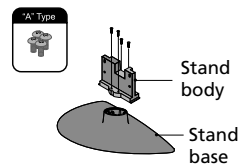

2. Using the screws provided assemble the stand body with the stand base as shown.

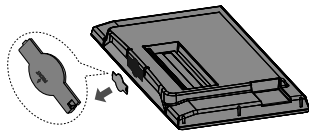

3. Remove the included stand cover from the product.

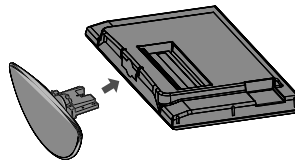

4. Assemble the product stand with the product as shown.

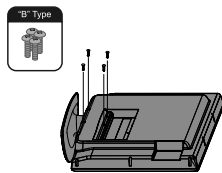

5. Install the 4 bolts securely, in the back of the product in the holes provided.

Note

- Image shown may differ from your TV.
- When mounting TV on the wall, install the included Stand Cover over the hole for the stand. Press the Stand Cover into the TV until you hear it click.

Chapter 1: Connections and Setup

Antenna Connection

Multi-family Dwellings/ Apartments
(Connect to wall antenna socket)



Wall Antenna Socket

RF Coaxial Wire (75 ohm)

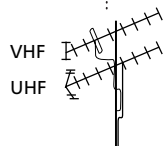

Outdoor Antenna



Single-family Dwellings /Houses
(Connect to wall jack for outdoor antenna)

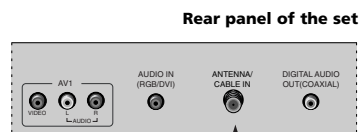

Rear panel of the set

Turn clockwise to tighten.

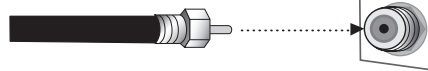

Be careful not to bend the bronze wire when connecting to an antenna port.

* Separately purchase a RF Coaxial Wire(75 ohm)

Note

- To improve the picture quality in a poor signal area, please purchase a signal amplifier and install properly.
- If the antenna is not installed properly, contact your dealer for assistance.

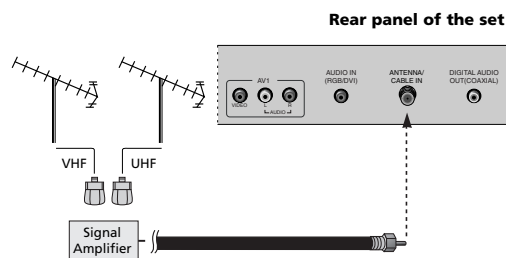

Chapter 1: Connections and Setup

VCR Connection

- To avoid picture noise (interference), leave an adequate distance between the TV and the VCR.

■ When connecting with an antenna

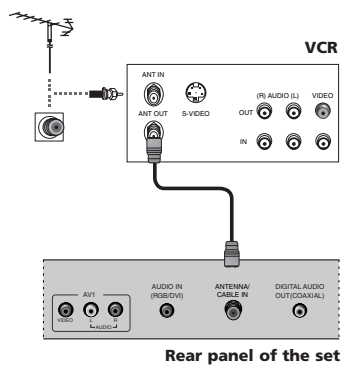

1. Connect the Antenna out socket of the VCR to the Antenna input socket on the TV.
2. Power up the VCR and Television.
3. Tune the TV to the channel output by the VCR. (typically ch.3 or 4.)
4. Refer to the VCR manual for operating instructions.

■ When connecting with an RCA cable - 22/26 inches

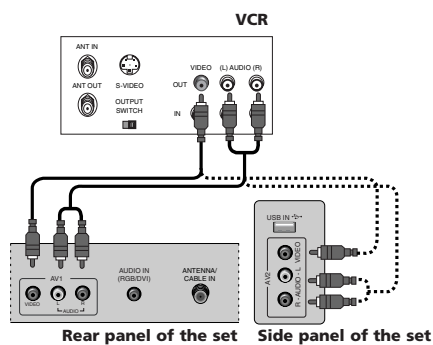

1. Connect the AUDIO/VIDEO jacks between TV and VCR. Match the jack colors (Video = yellow, Audio Left = white, and Audio Right = red)
2. Insert a video tape into the VCR and press **PLAY** on the VCR.
3. Select the **AV1** or **AV2** input source using the **INPUT** button on the remote control.
4. Refer to the VCR manual for operating instructions.

Chapter 1: Connections and Setup

■ When connecting with an RCA cable - 32 inch

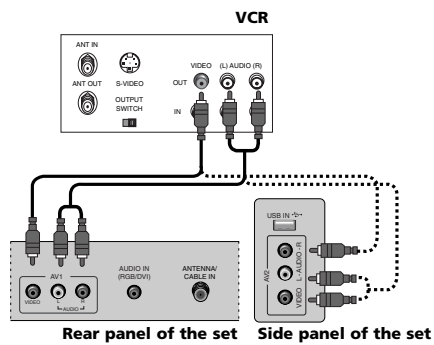

1. Connect the AUDIO/VIDEO jacks between TV and VCR. Match the jack colors (Video = yellow, Audio Left = white, and Audio Right = red)
2. Insert a video tape into the VCR and press **PLAY** on the VCR.
3. Select the **AV1** or **AV2** input source using the **INPUT** button on the remote control.
4. Refer to the VCR manual for operating instructions.

■ When connecting with an RCA cable - 42 inch

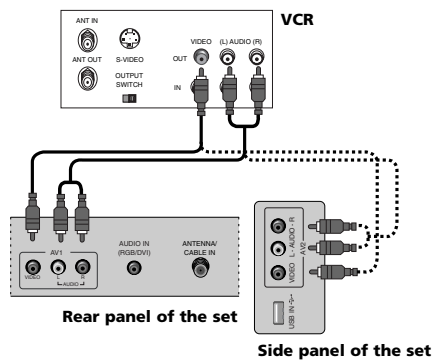

1. Connect the AUDIO/VIDEO jacks between TV and VCR. Match the jack colors (Video = yellow, Audio Left = white, and Audio Right = red)
2. Insert a video tape into the VCR and press **PLAY** on the VCR.
3. Select the **AV1** or **AV2** input source using the **INPUT** button on the remote control.
4. Refer to the VCR manual for operating instructions.

Chapter 1: Connections and Setup

DVD Connection

■ When connecting with a HDMI cable

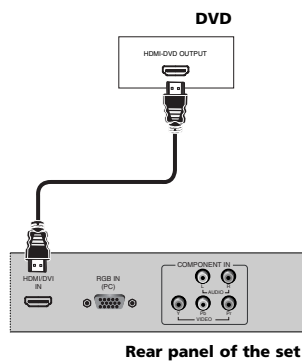

1. Connect the **HDMI** output of the DVD to the **HDMI/DVI IN** jack on the set.
2. Select **HDMI** input source using the **INPUT** button on the remote control.
3. Refer to the DVD player's manual for operating instructions.

■ When connecting with a Component cable

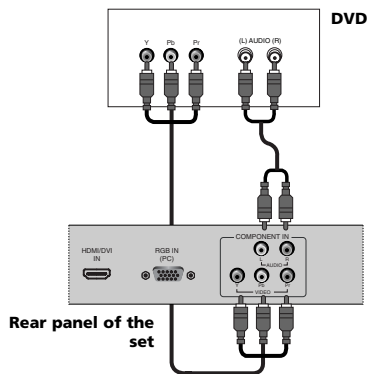

1. Connect the video outputs (Y, PB, PR) of the DVD to the **COMPONENT VIDEO (Y, Pb, Pr)** jacks on the set.
2. Connect the audio outputs of the DVD to the **COMPONENT AUDIO L, R** jacks on the set.
3. Turn on the DVD player, insert a DVD.
4. Select **YPbPr** source using the **INPUT** button on the remote control.
5. Refer to the DVD player's manual for operating instructions.

Chapter 1: Connections and Setup

HDSTB Connection

- This TV can receive Digital Over-the-air/Cable signals without an external digital set-top box. However, if you do receive Digital signals from a digital set-top box or other digital external device, refer to the figure as shown below.

■ When connecting with a D-Sub 15 pin cable - 26/32/42 inches

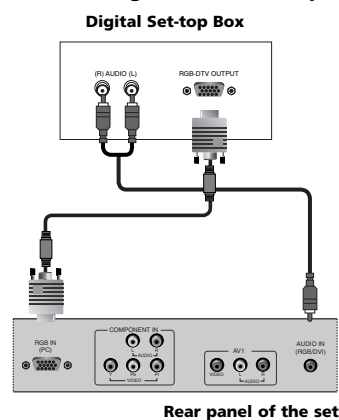

1. Connect the **RGB** output of the digital set-top box to the **RGB IN (PC)** jack on the set.
2. Connect the audio outputs of the set-top box to the **AUDIO IN (RGB/DVI)** jack on the set.
3. Turn on the digital set-top box.
4. Select **VGA** input source using the **INPUT** button on the remote control.
5. Refer to the digital set-top box manual for operating instructions.

■ When connecting with a D-Sub 15 pin cable - 22 inch

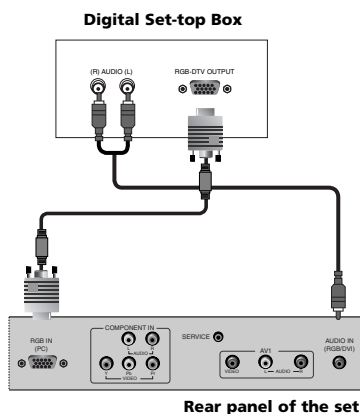

1. Connect the **RGB** output of the digital set-top box to the **RGB IN (PC)** jack on the set.
2. Connect the audio outputs of the set-top box to the **AUDIO IN (RGB/DVI)** jack on the set.
3. Turn on the digital set-top box.
4. Select **VGA** input source using the **INPUT** button on the remote control.
5. Refer to the digital set-top box manual for operating instructions.

■ **When connecting with a HDMI to DVI cable - 26/32/42 inches**

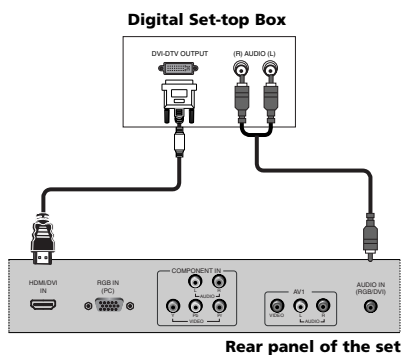

1. Connect the DVI output of the digital set-top box to the **HDMI/DVI IN** jack on the set.
2. Connect the audio outputs of the set-top box to the **AUDIO IN (RGB/DVI)** jack on the set.
3. Turn on the digital set-top box.
4. Select **HDMI** input source using the **INPUT** button on the remote control.
5. Refer to the digital set-top box manual for operating instructions.

■ **When connecting with a HDMI to DVI cable - 22 inch**

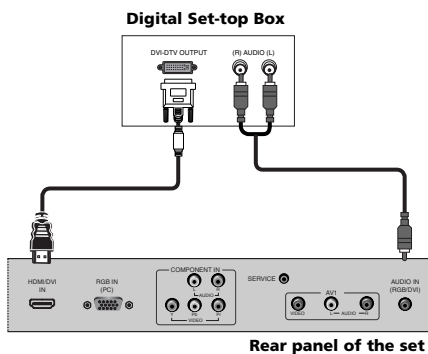

1. Connect the DVI output of the digital set-top box to the **HDMI/DVI IN** jack on the set.
2. Connect the audio outputs of the set-top box to the **AUDIO IN (RGB/DVI)** jack on the set.
3. Turn on the digital set-top box.
4. Select **HDMI** input source using the **INPUT** button on the remote control.
5. Refer to the digital set-top box manual for operating instructions.

Chapter 1: Connections and Setup

■ When connecting with a Component cable

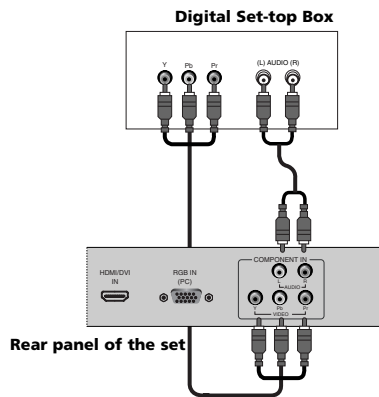

1. Connect the video outputs (Y, PB, PR) of the digital set-top box to the **COMPONENT VIDEO(Y, Pb, Pr)** jacks on the set.
2. Connect the audio outputs of the digital set-top box to the **COMPONENT AUDIO L, R** jacks on the set.
3. Turn on the digital set-top box.
4. Select **YPbPr** source using the **INPUT** button on the remote control.
5. Refer to the digital set-top box manual for operating instructions.

■ When connecting with a HDMI cable

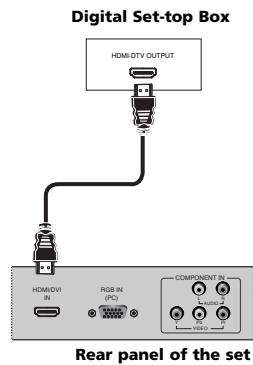

1. Connect the **HDMI** output of the digital set-top box to the **HDMI/DVI IN** jack on the set.
2. Turn on the digital set-top box.
3. Select **HDMI** input source using the **INPUT** button on the remote control.
4. Refer to the digital set-top box manual for operating instructions.

Chapter 1: Connections and Setup

External A/V Source - 22/26 inches

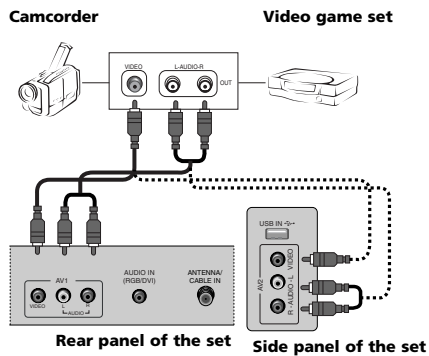

1. Connect the AUDIO/VIDEO jacks between TV and external equipment. Match the jack colors (Video = yellow, Audio Left = white, and Audio Right = red)
2. Select the **AV1** or **AV2** input source using the **INPUT** button on the remote control.
3. Operate the corresponding external equipment.
4. Refer to the external equipment manual for operating instructions.

External A/V Source - 32 inch

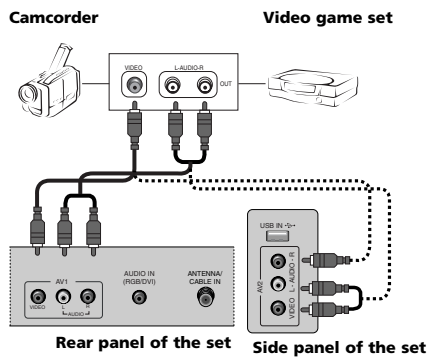

1. Connect the AUDIO/VIDEO jacks between TV and external equipment. Match the jack colors (Video = yellow, Audio Left = white, and Audio Right = red)
2. Select the **AV1** or **AV2** input source using the **INPUT** button on the remote control.
3. Operate the corresponding external equipment.
4. Refer to the external equipment manual for operating instructions.

Chapter 1: Connections and Setup

External A/V Source - 42 inch

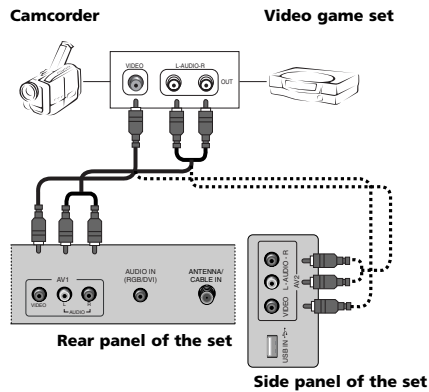

1. Connect the AUDIO/VIDEO jacks between TV and external equipment. Match the jack colors (Video = yellow, Audio Left = white, and Audio Right = red)
2. Select the **AV1** or **AV2** input source using the **INPUT** button on the remote control.
3. Operate the corresponding external equipment.
4. Refer to the external equipment manual for operating instructions.

Digital Audio Out

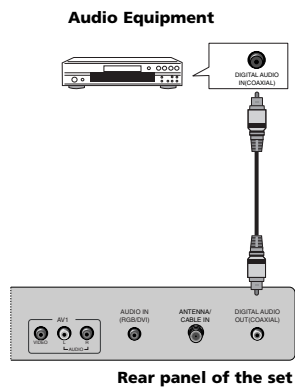

1. Connect one end of the optical cable to the TV's DIGITAL AUDIO OUT(OPTICAL) port.
2. Connect the other end of the optical cable to the digital audio input on the audio equipment.
3. Refer to the external audio equipment manual for operation.

Chapter 1: Connections and Setup

PC Connection

■ When connecting with a D-Sub 15 pin cable - 26/32/42 inches

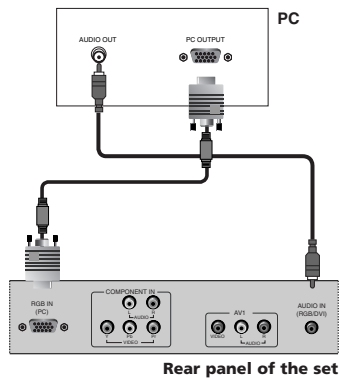

1. Connect the RGB output of the PC to the **RGB IN (PC)** jack on the set.
2. Connect the PC Audio Output to the **AUDIO IN (RGB/DVI)** jack on the TV using a male-to-male 3.5mm mini jack.
3. Turn on both the PC and TV.
4. Select the **VGA** input source on your TV by pressing either the **INPUT** buttons on the remote control.

■ When connecting with a D-Sub 15 pin cable - 22 inch

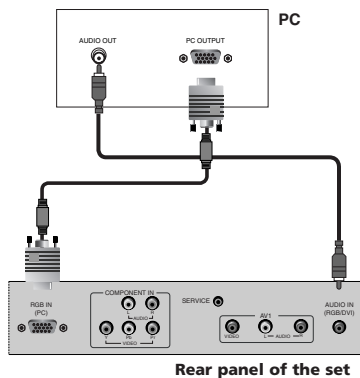

1. Connect the RGB output of the PC to the **RGB IN (PC)** jack on the set.
2. Connect the PC Audio Output to the **AUDIO IN (RGB/DVI)** jack on the TV using a male-to-male 3.5mm mini jack.
3. Turn on both the PC and TV.
4. Select the **VGA** input source on your TV by pressing either the **INPUT** buttons on the remote control.

Chapter 1: Connections and Setup

PC Connection

■ When connecting with a HDMI to DVI cable - 26/32/42 inches

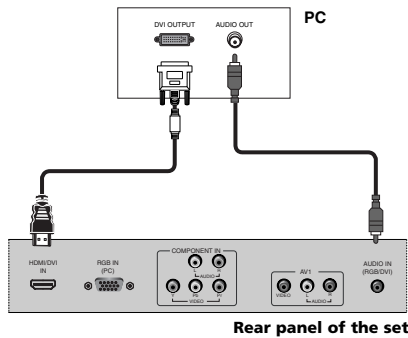

1. Connect the DVI Output on the PC to the **HDMI / DVI IN** Input jack on the TV.
2. Connect the PC Audio Output to the **AUDIO IN (RGB/DVI)** jack on the TV using a male-to-male 3.5mm mini jack.
3. Turn on both the PC and TV.
4. Select the **HDMI** input source on your TV by pressing either the **INPUT** buttons on the remote control.

■ When connecting with a HDMI to DVI cable - 22 inch

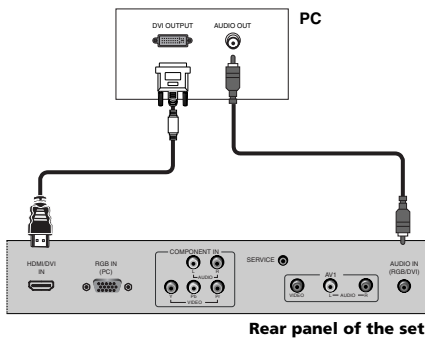

1. Connect the DVI Output on the PC to the **HDMI / DVI IN** Input jack on the TV.
2. Connect the PC Audio Output to the **AUDIO IN (RGB/DVI)** jack on the TV using a male-to-male 3.5mm mini jack.
3. Turn on both the PC and TV.
4. Select the **HDMI** input source on your TV by pressing either the **INPUT** buttons on the remote control.

Chapter 1: Connections and Setup

Resolution

■ PC

Resolution	Horizontal Frequency (kHz)	Vertical Frequency (Hz)
640 x 480	31.47	59.94
800 x 600	35.16	56.25
	37.88	60.32
1024 x 768	48.36	60.00

■ HDMI

Resolution	Vertical Frequency (Hz)
480/60P	60.000
720/60P	60.000
1080/60I	60.000
1080/60P	60.000

Note

- The synchronization input form is separate.
- If the resolution is not supported, 'Not Support!' message will be displayed.

USB Port

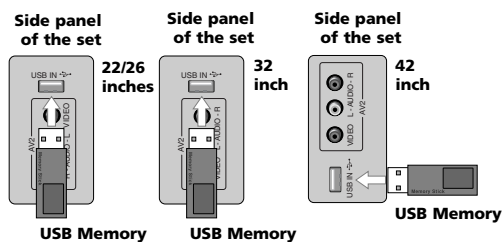

1. Connect the USB device to the USB IN jack on the set.
2. Select the **USB** input source using the **INPUT** button on the remote control.
3. Follow the on screen display to access the USB functions.

Chapter 2: Using the Remote Control

Basic(User) Remote

The basic remote control (R130K1) is used by the viewer for basic operating functions. It is designed so that the viewer cannot alter certain master remote-specified features. The Sleep, Closed Captioning, and Channel Guide features can be accessed directly with remote buttons.

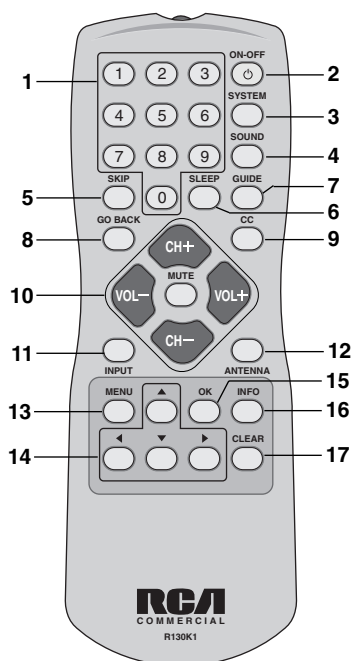

- 1. NUMBER BUTTONS**
Selects channel numbers.
- 2. ON-OFF**
Switches the set on or off.
- 3. SYSTEM**
Configures the remote for TV1/TV2.
Configures the remote preamble (Bed 1/Bed 2) for use with multi TVs in 1 room.
Press and hold <SYSTEM> and <1> key to set remote for "Bed1"(TV1).
Press and hold <SYSTEM> and <2> key to set the remote for "Bed2"(TV2). Refer to "Key Management", "RCU type" in Chapter 5.
- 4. SOUND**
Recalls your preferred sound setting.
- 5. SKIP**
Unused
- 6. SLEEP**
Sets the sleep timer.
- 7. GUIDE**
Display "Channel List" menu.
- 8. GO BACK**
Return to the previous menu.
- 9. CC**
Select the Caption menu directly.
- 10. VOL + / VOL -**
Adjusts sound level.
CH + / CH -
Select a channel.
MUTE
Switches the sound on or off.
- 11. INPUT**
Selects the **TV, AV1, AV2, YPbPr, VGA, HDMI** or **USB** mode.
- 12. ANTENNA**
Unused
- 13. MENU**
Displays "Basic" on screen menu.
There are 2 remotes for this TV;
R130K1 - user Remote. This remote displays a basic user menu when the menu key is pressed.
R130K2 - installer Remote. This remote displays an installer menu when the menu key is pressed.
- 14. Navigational Controls**
Adjusts menu settings.
Selects menu item.
- 15. OK**
Accepts your selection.
- 16. INFO**
Display the current channel information.
- 17. CLEAR**
Exit from any OSD.

Chapter 2: Using the Remote Control

Master(Installer) Remote

The master remote control (R130K2) accesses all of the TV's menus. It is used to customize the TV's functionality for specific users or specific situations.

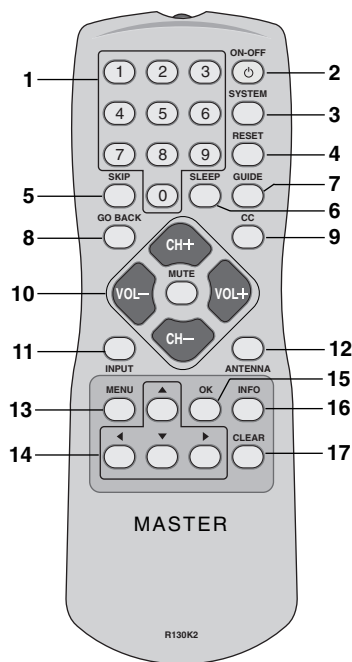

Put Batteries in the Remote

- Remove the battery compartment cover from the back of the remote by pushing the tab and lifting off the cover.
- Insert two fresh batteries. Make sure the polarities (+ and -) are aligned correctly.
- Replace the cover.

1. NUMBER BUTTONS

Selects channel numbers.

2. ON-OFF

Switches the set on or off.

3. SYSTEM

Configures the remote for TV1/TV2.

Configures the remote preamble (Bed 1/Bed 2) for use with multi TVs in 1 room. Press and hold <SYSTEM> and <1> key to set remote for "Bed1".

Press and hold <SYSTEM> and <2> key to set the remote for "Bed2". Refer to "Key Management," "RCU type" in Chapter 5.

4. RESET

Unused.

5. SKIP

Unused

6. SLEEP

Sets the sleep timer.

7. GUIDE

Display "Channel List" menu.

8. GO BACK

Return to the previous menu.

9. CC

Select the Caption menu directly.

10. VOL + / VOL -

Adjusts sound level.

CH + / CH -

Select a channel.

MUTE

Switches the sound on or off.

11. INPUT

Selects the TV, AV1, AV2, YPbPr, VGA, HDMI or USB mode.

12. ANTENNA

Unused

13. MENU

Displays "Installer" on screen menu.

There are 2 remotes for this TV; R130K1 - user Remote. This remote displays a basic user menu when the menu key is pressed.

R130K2 - installer Remote. This remote displays an installer menu when the menu key is pressed.

14. Navigational Controls

Adjusts menu settings.

Selects menu item.

15. OK

Accepts your selection.

16. INFO

Display the current channel information.

17. CLEAR

Exit from any OSD.

Chapter 3: Using USB Clone Tool

USB Cloner Operation

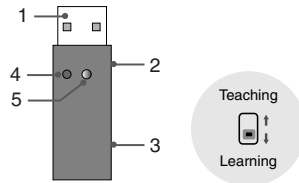

1. USB Connector

Connects to the USB port of the TV or PC.

2. Service Port

Connects to the service port of the television. See "Learning" section for details.

3. Mode Switch

Mode Selection Switch.

4. Status LED

Shows the status of the USB Clone.

5. Learn Button

Button to start the "learn" process. See "learning" section for details.

Errors Table

Flashing Red/Green LED indicates the following error conditions.

		Number of Green LED Flashes
1	Error Detected in TV Channel list file.	4
2	Error in transmission Data Packet	5
3	No response from service port.	6
4	Couldn't save TV settings to USB Cloner	10

Chapter 3: Using USB Clone Tool

Learning - 22inch

Copying settings out of TV.

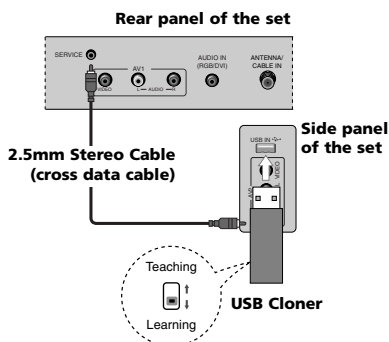

1. Turn TV on.
2. Connect USB Cloner to TV USB Port.
3. Set switch to "learning" position. (Status LED will Light red without flashing.)
4. Connect 2.5mm Stereo Cable (cross data cable) between the TV service port and the USB Cloner service port.
5. Press the Learn button for 1 second. As soon as the LED turns green, release the button.
6. The LED will turn Red and flash while the settings are being saved to the USB Key. Upon successful copy, the LED will light up yellow for 2 seconds and then return to a red, constantly lit state. Upon an unsuccessful copy, the LED will flash an error code as described in the "Error Table" section.

Note : New TV Settings file, "ChList.bin" will appear on the USB Cloner .

Learning - 26 inch

Copying settings out of TV.

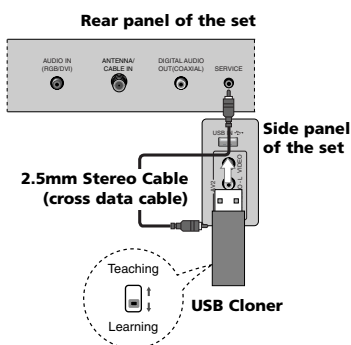

1. Turn TV on.
2. Connect USB Cloner to TV USB Port.
3. Set switch to "learning" position. (Status LED will Light red without flashing.)
4. Connect 2.5mm Stereo Cable (cross data cable) between the TV service port and the USB Cloner service port.
5. Press the Learn button for 1 second. As soon as the LED turns green, release the button.
6. The LED will turn Red and flash while the settings are being saved to the USB Key. Upon successful copy, the LED will light up yellow for 2 seconds and then return to a red, constantly lit state. Upon an unsuccessful copy, the LED will flash an error code as described in the "Error Table" section.

Note : New TV Settings file, "ChList.bin" will appear on the USB Cloner .

Chapter 3: Using USB Clone Tool

Learning - 32inch

Copying settings out of TV.

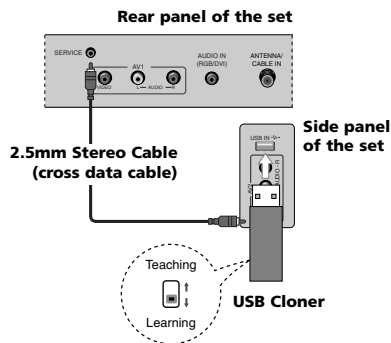

1. Turn TV on.
2. Connect USB Cloner to TV USB Port.
3. Set switch to "learning" position. (Status LED will Light red without flashing.)
4. Connect 2.5mm Stereo Cable (cross data cable) between the TV service port and the USB Cloner service port.
5. Press the Learn button for 1 second. As soon as the LED turns green, release the button.
6. The LED will turn Red and flash while the settings are being saved to the USB Key. Upon successful copy, the LED will light up yellow for 2 seconds and then return to a red, constantly lit state. Upon an unsuccessful copy, the LED will flash an error code as described in the "Error Table" section.

Note : New TV Settings file, "ChList.bin" will appear on the USB Cloner .

Learning - 42inch

Copying settings out of TV.

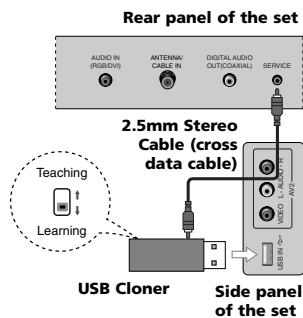

1. Turn TV on.
2. Connect USB Cloner to TV USB Port.
3. Set switch to "learning" position. (Status LED will Light red without flashing.)
4. Connect 2.5mm Stereo Cable (cross data cable) between the TV service port and the USB Cloner service port.
5. Press the Learn button for 1 second. As soon as the LED turns green, release the button.
6. The LED will turn Red and flash while the settings are being saved to the USB Key. Upon successful copy, the LED will light up yellow for 2 seconds and then return to a red, constantly lit state. Upon an unsuccessful copy, the LED will flash an error code as described in the "Error Table" section.

Note : New TV Settings file, "ChList.bin" will appear on the USB Cloner .

Chapter 3: Using USB Clone Tool

Teaching - 22/26 inches

Placing settings into TV.

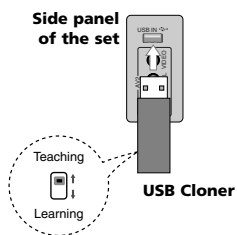

1. Connect USB Cloner to TV USB Port.
2. Set mode switch to "teach".
(Status LED will flash red)
3. Turn off TV Power.
4. Turn on TV Power.
TV settings will be copied into television.

Note : TV Settings file "ChList.bin" should be present on USB clone device for teaching function to work properly. Refer to "Learning" section for details.

Teaching - 32 inch

Placing settings into TV.

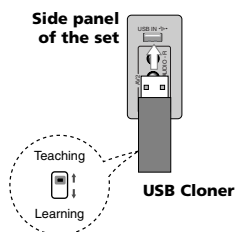

1. Connect USB Cloner to TV USB Port.
2. Set mode switch to "teach".
(Status LED will flash red)
3. Turn off TV Power.
4. Turn on TV Power.
TV settings will be copied into television.

Note : TV Settings file "ChList.bin" should be present on USB clone device for teaching function to work properly. Refer to "Learning" section for details.

Teaching - 42 inch

Placing settings into TV.

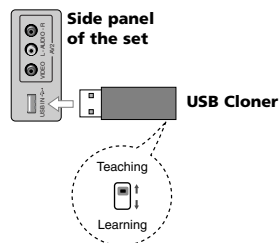

1. Connect USB Cloner to TV USB Port.
2. Set mode switch to "teach".
(Status LED will flash red)
3. Turn off TV Power.
4. Turn on TV Power.
TV settings will be copied into television.

Note : TV Settings file "ChList.bin" should be present on USB clone device for teaching function to work properly. Refer to "Learning" section for details.

Chapter 4: Basic Operation

Plug in the TV

Plug the end of the power cord into the back of the TV. Plug the other end into a grounded wall outlet. Insert the plug completely into the outlet. Do not plug into an outlet controlled by a light switch.

Turn on the TV

Turn on your TV by pressing the Power button on the front of the TV or ON-OFF on the remote control.

Channel Scan

This function automatically finds all channels available through the Antenna or Cable and stores them in memory on the channel list.

Channel Scans can only be performed using a Master remote.

Channel Selection

You can select a channel number with the **CH + / CH -** button or NUMBER buttons.

Volume Adjustment

Press the **VOL+ / VOL-** button to adjust the sound level.

Sound Mute

Press the **MUTE** button. The sound is switched off and the mute Icon appears. To cancel mute mode, press the **MUTE** or **VOL+ / VOL-** button again.

Chapter 4: Basic Operation

Source Selection

1. Press the **INPUT** button to change the input mode.
2. Press the **Down** or **Up** button to select your desired mode.
3. Press the **OK** button to change your selected mode.

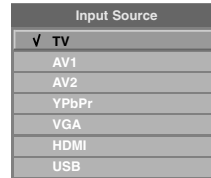

Language Selection

1. Press the **MENU** button and then press the **Down** or **Up** button to select the **Setup**.
2. Press the **OK** button and then press the **Down** or **Up** button to select **OSD Language**.
3. Press the **Left** or **Right** button to select your desired language.
(Select between **English, Español, Français**)
4. The on screen menu will then appear in the selected language.

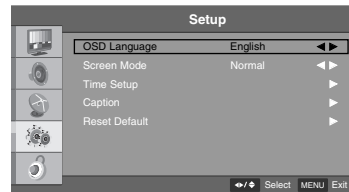

Chapter 5: Commercial Interface Menus

These TVs include a full commercial interface that allows your facility to customize the performance to your specific needs. These settings are only accessible to the installer with the use of the Master Remote(R130K2). Contact your RCA Commercial Distribution to obtain a master remote.

You can access this menu by pressing MENU -> 9 -> 6 -> 3 -> 2 using the Master Remote.

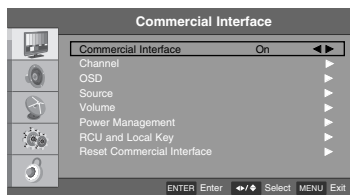

- You must set "Commercial Interface" to "On" to activate the below items.

Channel

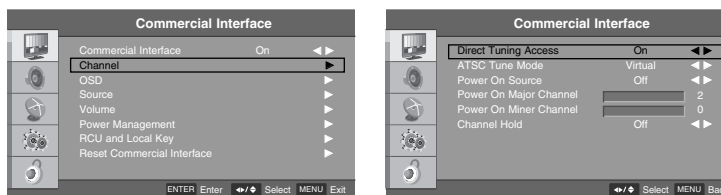

- Direct Tuning Access : If this function is on, you can tune to channels even if the channels are not in the channel list using the numeric keys. If this function is off, only channels in the channel list can be tuned.
- ATSC Tune Mode : This function sets the channel frequency type for Digital Channels to physical or virtual. If the facility has a head end signal distribution system, set this to "physical".
- Power On Source : Use this setting to configure the signal source of the TV when it is turned on.
- Power On Major/Minor Channel : Use this setting to configure the initial channel of the TV when it is turned on.
Note: "Power On Source" should be set to "TV" to use this setting.
To tune to an analog channel, set minor channel to 0.
- Channel Hold : If this function is on then you cannot change channels.

OSD

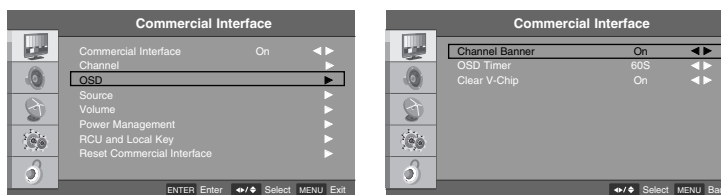

- Channel Banner : If this function is off then channel banner will not appear when channel is changed.
- OSD Timer : Use this setting to configure the menu OSD time out.
- Clear V-Chip : This function can be used to Clear V-Chip password and settings.

Chapter 5: Commercial Interface Menus

Source



- Input Block : Use this setting to configure which inputs are available to the user through the input button.

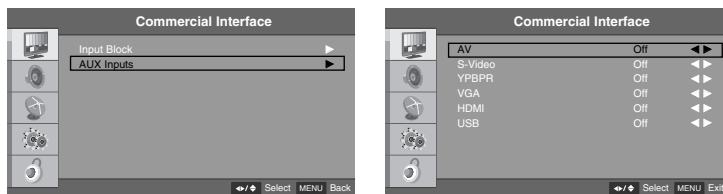

- AUX Inputs : Use this setting to place inputs into the channel list. If you place an input in the channel list, the user can access the input using the CH buttons on the remote and Pillow Speaker.

Volume

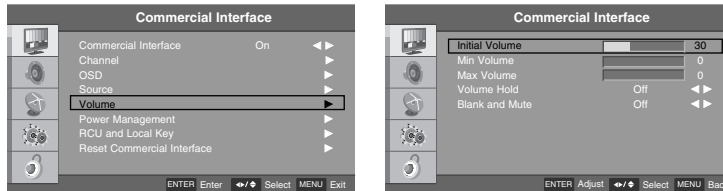

- Initial Volume : This setting configures the turn on volume of the TV.
- Min Volume : This setting assigns the minimum volume level that the user can access.
- Max Volume : This setting assigns the maximum volume level that the user can access.
- Volume Hold : If this function is on then user cannot adjust volume level
- Blank and Mute : If this function is on, sound will be muted when video is not present on the external video source.

Chapter 5: Commercial Interface Menus

Power Management

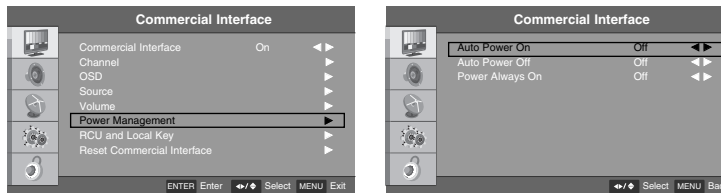

- Auto Power On : This function sets the power state when AC power is applied to the TV.
 - + Off : TV will go to standby mode
 - + On : TV will turn on
 - + Last : TV will resume the state it was in before AC power was removed.
- Auto Power Off : This function assigns the amount of time an inactive TV will remain on. It can be used by your facility to save energy.
- Power Always On : TV can not be turned off.

Key Management

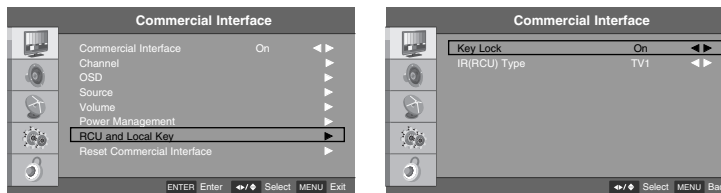

- Key Lock : This setting disables the keys on the front of the TV.
- RCU Type : This function assigns RCU type as TV1, TV2. This is used when more than 1 TV is being installed in the same room.
Note : The remote must be configured to send the matching RCU Type corresponding to this setting. This is done as follows : On the R130 K1 remote, press hold <SYSTEM> and <1> keys for 5 seconds to set it to "TV1". Press and hold <SYSTEM> and <2> keys for 5 seconds to set it to "TV2".

Reset Commercial Reset

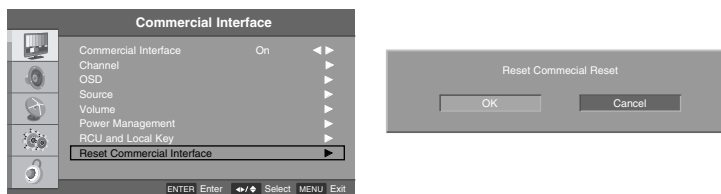

- This function will reset all data in the commercial interface menu to the factory defaults.

Chapter 6: Using the TV's Features

On Screen Menus

Your TV's OSD(On Screen Display) may differ slightly from what is shown in this manual.

1. Press the **MENU** button and then press the **Down** or **Up** button to select each menu.
2. Press the **OK** button and then **Down, Up, Left** and **Right** buttons to navigate to the available menus.

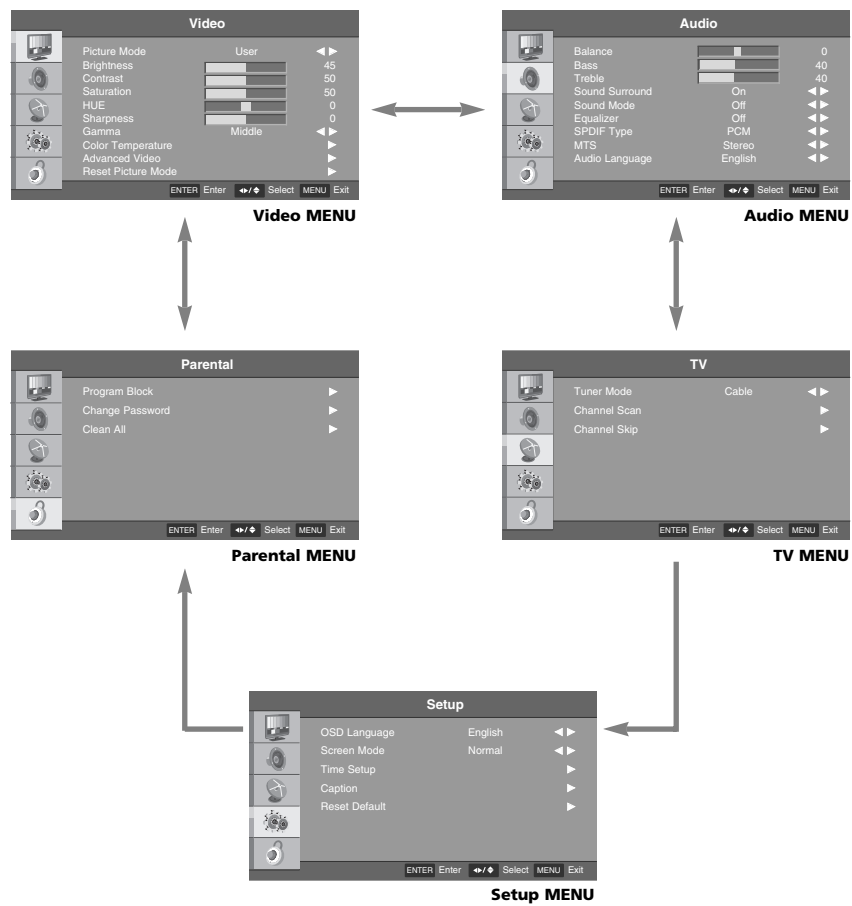

Chapter 6: Using the TV's Features

Note : Some of these menu items can only be accessed using the Master Remote(R130K2).

Setting up the TV Channel

This TV prevents the user from changing the channel list.

Auto Scan

This function automatically finds all channels available through the Antenna or Cable and stores them in memory as the channel list.

1. Press the **MENU** button on the master remote to enter the on-screen menu and then press either the **Down** or **Up** button to select the **TV** sub-menu.
2. Press the **OK** button to enter the sub-menu and then press either the **Down** or **Up** button to select **Tuner Mode**.
3. Press the **Left** or **Right** button to select either **Antenna** or **Cable**.
4. Press the **Down** or **Up** button to select **Channel Scan**.
5. Press the **OK** button to start the auto search. The TV will begin memorizing all of the available channels.
6. Press the **MENU** button at any time to exit the channel scan process.
7. Once the channel scan is complete the channels found and recognized by the TV will be available for viewing.

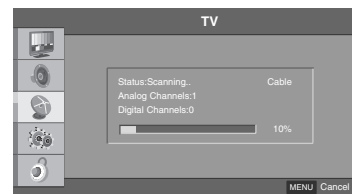
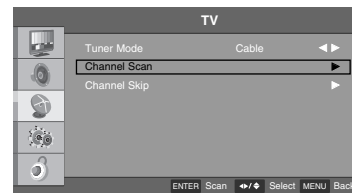
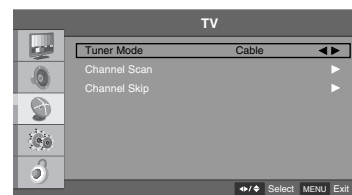

Chapter 6: Using the TV's Features

Add / Delete a Channel

You can manually store or remove channels in whatever order you desire.

1. Press the **MENU** button on the master remote to enter the on-screen menu and then press either the **Down** or **Up** button to select the **TV** sub-menu.
2. Press the **OK** button to enter the sub-menu and then press either the **Down** or **Up** button to select **Channel Skip**.
3. Press the **OK** button and then press the **Down** or **Up** button to select channel you want to add or delete.
If you want to skip the selected channel, press the **OK** button to uncheck your selection.
4. All channels that have a check will be added to your viewing selection.
5. Press the **MENU** button to return to the previous menu.

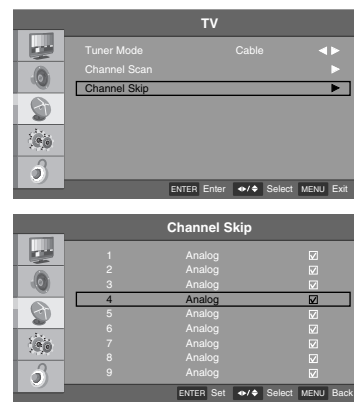

Chapter 6: Using the TV's Features

Picture Controls

Adjusting The Picture Controls

The various Picture Modes allow you to adjust the display to your viewing preference.

1. Press the **MENU** button to enter the on-screen menu and then press either the **Down** or **Up** button to select the **Video** sub-menu.
2. Press the **OK** button to enter the sub-menu and then press either the **Down** or **Up** button to select **Picture Mode**.
3. Press the **Left** or **Right** button to select between **Cinema**, **Sport**, **Vivid**, **Hi-Bright** or **User** Picture Modes.
4. Press the **MENU** button to return to the previous menu.



Chapter 6: Using the TV's Features

Manual Picture Controls

You can adjust picture Brightness, Contrast, Saturation, HUE and Sharpness to the levels you prefer.

1. Press the **MENU** button to enter the on-screen menu and then press either the **Down** or **Up** button to select the **Video** sub-menu.
2. Press the **OK** button to enter the sub-menu and use the **Left** or **Right** button to change the picture mode to **User**. Then, press either the **Down** or **Up** button to scroll to the desired picture option. (**Brightness, Contrast, Saturation, HUE, Sharpness**)
3. Press the **OK** button and then use the **Left** or **Right** button to adjust the selection to your preference.
4. Press the **MENU** button to return to the previous menu.

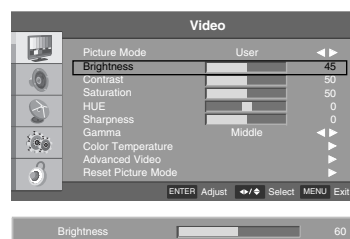

- **Brightness**
Increases or decreases amount of white in the your picture.
- **Contrast**
Adjusts the difference between the light and dark levels in the picture.
- **Saturation**
Adjusts intensity of all colors.
- **HUE**
Adjusts the balance between red and green levels.
- **Sharpness**
Adjusts the level of sharpness in the edges between the light and dark areas of the picture. The lower the level, the softer the image.

Chapter 6: Using the TV's Features

Gamma

This feature will allow you to adjust the brightness curve for the display.

1. Press the **MENU** button to enter the on-screen menu and then press either the **Down** or **Up** button to select the **Video** sub-menu.
2. Press the **OK** button to enter the sub-menu and then press either the **Down** or **Up** button to select **Gamma**.
3. Press the **Left** or **Right** button to select between **Dark**, **Middle** or **Bright**.
4. Press the **MENU** button to return to the previous menu.



Chapter 6: Using the TV's Features

Color Temperature

The Color Temperature settings will allow you to adjust the lighting in the display to compliment your viewing preference.

The Cool setting will add more Blues and Greens into the image to give it a "cooler " feeling.

The Warm setting will add more Reds and Yellows into the image to give it a "warmer " feeling.

The Standard setting will be a more natural feeling and will fall between the Cool and Warm settings.

1. Press the **MENU** button to enter the on-screen menu and then press either the **Down** or **Up** button to select the **Video** sub-menu.
2. Press the **OK** button to enter the sub-menu and then press either the **Down** or **Up** button to select and enter into the **Color Temperature** submenu.
3. Press the **OK** button and then press the **Left** or **Right** button to select between **Cool**, **Standard**, **Warm** or **User** settings.
4. If you selected the User setting, press the **Down** or **Up** button to select desired color option you wish to adjust.
5. Press the **OK** button and then use the **Left** or **Right** button to make appropriate adjustments.
6. Press the **MENU** button to return to the previous menu.

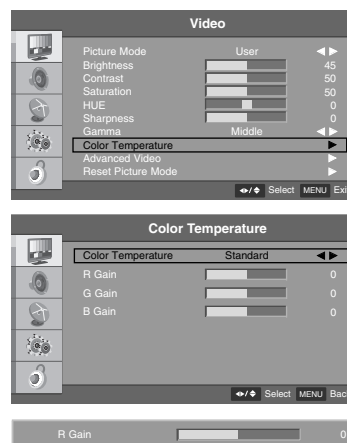

Note

- To adjust manually Color Temperature on your display, change the **Color Temperature** Mode to **User**.

Chapter 6: Using the TV's Features

Reset Picture Mode

When changing your settings, you can select the Reset Picture Mode option to restore the previous settings.

1. Press the **MENU** button to enter the on-screen menu and then press either the **Down** or **Up** button to select the **Video** sub-menu.
2. Press the **OK** button to enter the sub-menu and use the **Down** or **Up** button to select **Reset Picture Mode**.
3. Once the confirmation window appears, press **OK** to restore the previous settings.

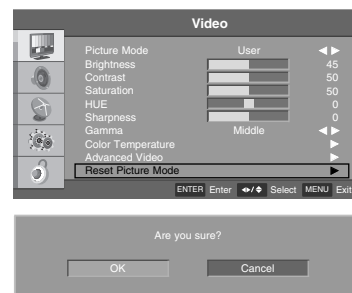

Chapter 6: Using the TV's Features

Advanced Video

Dynamic Noise Reduction

Use this feature to reduce the amount of noise, or film grain, that may be present in the picture.

1. Press the **MENU** button to enter the on-screen menu and then press either the **Down** or **Up** button to select the **Video** sub-menu.
2. Press the **OK** button to enter the sub-menu and then press either the **Down** or **Up** button to select **Advanced Video**.
3. Press the **OK** button to enter the submenu and then press the **Down** or **Up** button to select **DNR**.
4. Press the **Left** or **Right** button to select between **Off**, **Low**, **Medium**, **Strong** or **Auto**.
5. Press the **MENU** button to return to the previous menu.

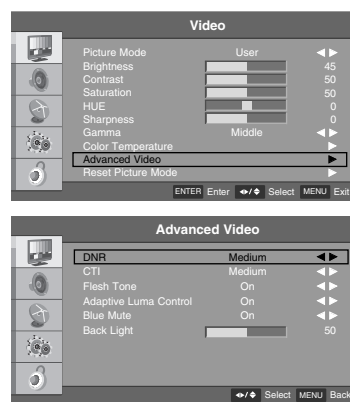

- **Off**
Turns the screen noise reduction function off.
- **Low**
Reduces screen noise at a low level.
- **Medium**
Reduces screen noise at a medium level.
- **Strong**
Reduces screen noise at a high level.
- **Auto**
Automatically adjusts the noise reduction level according to received signal.

Chapter 6: Using the TV's Features

CTI (Color Transient Intensity)

This feature is used to reduce the time the display takes to transition from one color to another. The effect of CTI will be seen as sharpening the border between colors.

1. Press the **MENU** button to enter the on-screen menu and then press either the **Down** or **Up** button to select the **Video** sub-menu.
2. Press the **OK** button to enter the sub-menu and then press either the **Down** or **Up** button to select **Advanced Video**.
3. Press the **OK** button and then press the **Down** or **Up** button to select **CTI**.
4. Press the **Left** or **Right** button to select **Off**, **Low**, **Medium** or **Strong**.
5. Press the **MENU** button to return to the previous menu.

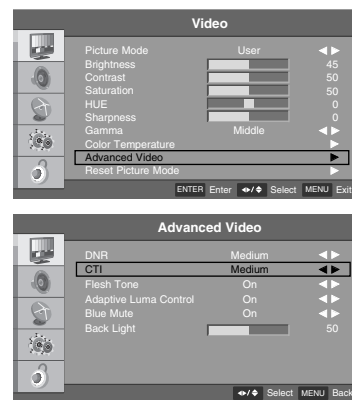

Flesh Tone

In some cases, activation of this feature can result in a more pleasing display of sky and flesh colors.

1. Press the **MENU** button to enter the on-screen menu and then press either the **Down** or **Up** button to select the **Video** sub-menu.
2. Press the **OK** button to enter the sub-menu and then press either the **Down** or **Up** button to select **Advanced Video**.
3. Press the **OK** button and then press the **Down** or **Up** button to select **Flesh Tone**.
4. Press the **Left** or **Right** button to select **On** or **Off**.
5. Press the **MENU** button to return to the previous menu.

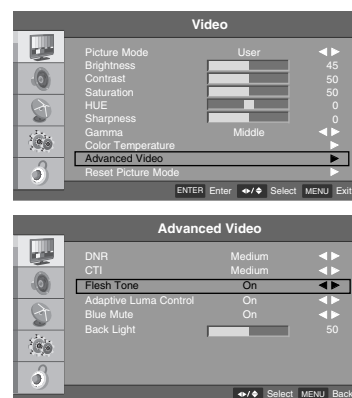

Chapter 6: Using the TV's Features

Adaptive Luma Control

Large amounts of dark areas present in a picture will result in a lower Average Picture Level (APL) and the overall picture will look too dark; activation of this feature will raise the APL to counteract this effect.

1. Press the **MENU** button to enter the on-screen menu and then press either the **Down** or **Up** button to select the **Video** sub-menu.
2. Press the **OK** button to enter the sub-menu and then press either the **Down** or **Up** button to select **Advanced Video**.
3. Press the **OK** button and then press the **Down** or **Up** button to select **Adaptive Luma Control**.
4. Press the **Left** or **Right** button to select **On** or **Off**.
5. Press the **MENU** button to return to the previous menu.

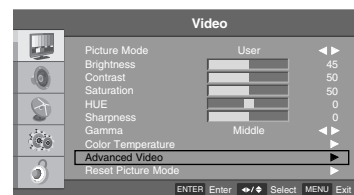

Blue Mute

Screen can be set to blue color when video signal is not existed.

1. Press the **MENU** button to enter the on-screen menu and then press either the **Down** or **Up** button to select the **Video** sub-menu.
2. Press the **OK** button to enter the sub-menu and then press either the **Down** or **Up** button to select **Advanced Video**.
3. Press the **OK** button and then press the **Down** or **Up** button to select **Blue Mute**.
4. Press the **Left** or **Right** button to select between **On** or **Off**.
5. Press the **MENU** button to return to the previous menu.

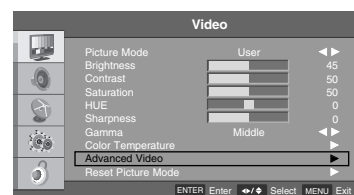

Chapter 6: Using the TV's Features

Back Light

Adjusts the brightness level of the back light.

Increasing the Back Light level will result in a brighter picture and is recommended for use brightly lit rooms, however, it will also decrease your black levels and results in a higher power consumption.

1. Press the **MENU** button to enter the on-screen menu and then press either the **Down** or **Up** button to select the **Video** sub-menu.
2. Press the **OK** button to enter the sub-menu and then press either the **Down** or **Up** button to select **Advanced Video**.
3. Press the **OK** button and then press the **Down** or **Up** button to select **Back Light**.
4. Press the **Left** or **Right** button to adjust the selection to your preference.
5. Press the **MENU** button to return to the previous menu.



Chapter 6: Using the TV's Features

Screen Mode

You can watch the screen in various picture formats. Screen size selection depends on the type of video input.

1. Press the **MENU** button to enter the on-screen menu and then press either the **Down** or **Up** button in order to select the **Setup** sub-menu.
2. Press the **OK** button and then press the **Down** or **Up** button to select **Screen Mode**.
3. Press the **Left** or **Right** button to select **Normal**, **Letterbox**, **Panorama** or **Auto**.
4. Press the **MENU** button to return to the previous menu.

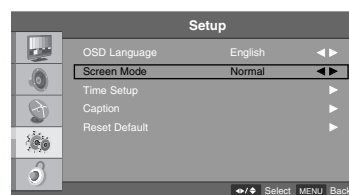

- **Normal**
This selection is used to fill the entire screen with the image so no black bars appear
- **Letterbox**
Following selection will lead you to view a picture with an original 4:3 aspect ratio, with black bars appearing at both the left and right sides.
- **Panorama**
When your set receives the wide screen signal, when selected it will adjust the picture horizontally, in non-linear proportion, to fill the entire screen.
- **Auto**
When your set receives the wide screen signal, it will change automatically the picture format that has been sent.

Chapter 6: Using the TV's Features

Sound Controls

Adjusting The Sound Controls

The Sound Mode preset selection will allow you to adjust the sound to your listening preference.

1. Press the **MENU** button to enter the on-screen menu and then press either the **Down** or **Up** button to select the **Audio** sub-menu.
2. Press the **OK** button to enter the sub-menu and then press either the **Down** or **Up** button to select **Sound Mode**.
3. Press the **Left** or **Right** button to select between **Off**, **Concert**, **Living Room**, **Hall**, **Bathroom**, **Cave**, **Arena** or **Church** Modes.
4. Press the **MENU** button to return to the previous menu.



Chapter 6: Using the TV's Features

Manual Sound Controls

This function allows you to manually adjust the individual audio settings to your preferred levels.

1. Press the **MENU** button to enter the on-screen menu and then press either the **Down** or **Up** button to select the **Audio** sub-menu.
2. Press the **OK** button to enter the sub-menu and then press either the **Down** or **Up** button to select the desired sound option. (**Balance**, **Bass**, **Treble**)
3. Press the **OK** button to select the sound option that you wish to change and then press either the **Left** or **Right** button to make appropriate adjustments.
4. Press the **MENU** button to return to the previous menu.

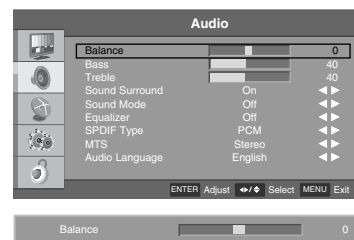

- **Balance**
Adjusts the left to right sound balance between the built-in speakers.
- **Bass**
This adjusts the presence of the lower frequency audio.
- **Treble**
This adjusts the presence of the higher frequency audio.

Chapter 6: Using the TV's Features

Sound Surround

Surround sound adds an extra dimension to the depth of the sound.

1. Press the **MENU** button to enter the on-screen menu and then press either the **Down** or **Up** button to select the **Audio** sub-menu.
2. Press the **OK** button to enter the sub-menu and then press either the **Down** or **Up** button to select **Sound Surround**.
3. Press the **Left** or **Right** button to select between **On** or **Off**.
4. Press the **MENU** button to return to the previous menu.



Equalizer

User can enable equalizer mode.

1. Press the **MENU** button to enter the on-screen menu and then press either the **Down** or **Up** button to select the **Audio** sub-menu.
2. Press the **OK** button to enter the sub-menu and then press either the **Down** or **Up** button to select **Equalizer**.
3. Press the **Left** or **Right** button to select between **Rock, Pop, Live, Dance, Techno, Classic, Soft** or **Off**.
4. Press the **MENU** button to return to the previous menu.

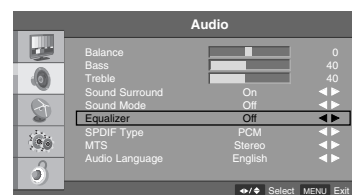

Chapter 6: Using the TV's Features

Digital Output

This option activates the Digital Audio Output. This is recommended for use with other devices capable of receiving digital audio signals. (This mode is set to Off by default)

1. Press the **MENU** button to enter the on-screen menu and then press either the **Down** or **Up** button to select the **Audio** sub-menu.
2. Press the **OK** button to enter the sub-menu and then press either the **Down** or **Up** button to select **SPDIF Type**.
3. Press the **Left** or **Right** button to select between **Off**, **Dolby Digital** or **PCM**.
4. Press the **MENU** button to return to the previous menu.



- **Off**
Television will only output an Analog audio signal. (This mode is set to Off by default)
- **Dolby Digital**
Television will output a digital audio signal.
- **PCM (Pulse-code modulation)**
This mode creates a digital representation of an analog signal and is only used with an audio CD signal.



Manufactured under license from
Dolby Laboratories.
"Dolby" and the double-D symbol
are trademarks of Dolby
Laboratories.

Chapter 6: Using the TV's Features

Stereo/SAP Broadcast Setup

This TV can receive MTS stereo programs and any SAP (Secondary Audio Program) that the station may transmit.

The television will automatically switch to Mono sound if the broadcasted channel is transmitted in Mono.

1. Press the **MENU** button to enter the on-screen menu and then press either the **Down** or **Up** button to select the **Audio** sub-menu.
2. Press the **OK** button to enter the sub-menu and then press either the **Down** or **Up** button to select **MTS**.
3. Press the **Left** or **Right** button to select between **Stereo**, **SAP** or **Mono**.
4. Press the **MENU** button to return to the previous menu.



Audio Language

Other languages may be available if a digital signal is provided by the broadcasting station.

1. Press the **MENU** button to enter the on-screen menu and then press either the **Down** or **Up** button to select the **Audio** sub-menu.
2. Press the **OK** button to enter the sub-menu and then press either the **Down** or **Up** button to select **Audio Language**.
3. Press the **Left** or **Right** button to select between **English**, **Español** or **Français**.
4. Press the **MENU** button to return to the previous menu.



Chapter 6: Using the TV's Features

Time Setting

Time Zone Settings

This mode allows you to set the Time Zone for your local area.

1. Press the **MENU** button to enter the on-screen menu and then press either the **Down** or **Up** button in order to select the **Setup** sub-menu.
2. Press the **OK** button to enter the submenu and then press either the **Down** or **Up** button in order to select **Time Setup**.
3. Press the **OK** button and then press the **Down** or **Up** button to select **Time Zone**.
4. Use the **Left** or **Right** button to select your viewing area's time zone. (Select between: **Eastern Time, Indiana, Central Time, Mountain Time, Arizona, Pacific Time, Alaska, Hawaii**)
5. Press the **MENU** button to return to the previous menu.



Chapter 6: Using the TV's Features

Auto Time Settings

The Auto Time Setting receives the current time from an available digital channel. The digital channel signal includes information for the current time provided by the broadcasting station.

1. Press the **MENU** button to enter the on-screen menu and then press either the **Down** or **Up** button in order to select the **Setup** sub-menu.
2. Press the **OK** button to enter the submenu and then press either the **Down** or **Up** button in order to select **Time Setup**.
3. Press the **OK** button and then press the **Down** or **Up** button to select **Time**.
4. Press the **OK** button and then press the **Down** or **Up** button to select **Auto Synchronization**.
5. Press the **Left** or **Right** button to switch between **On** or **Off**.
6. Press the **MENU** button to return to the previous menu.

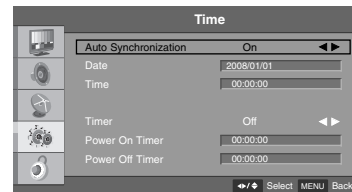
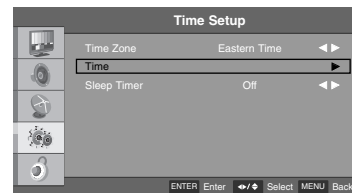
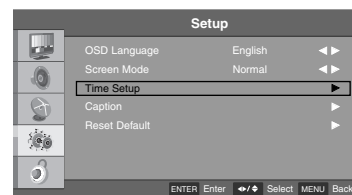

Note

- If Auto Synchronization is On, the Date and Time menus cannot be adjusted.
- Set the time manually if the current time is incorrect using the Auto Synchronization function.

Chapter 6: Using the TV's Features

Manual Time Settings

If the current time setting is wrong when using the Auto Synchronization function, this setting allows you to set the clock manually.

1. Press the **MENU** button to enter the on-screen menu and then press either the **Down** or **Up** button in order to select the **Setup** sub-menu.
2. Press the **OK** button to enter the submenu and then press either the **Down** or **Up** button in order to select **Time Setup**.
3. Press the **OK** button and then press the **Down** or **Up** button to select **Time**.
4. Press the **OK** button and then press the **Down** or **Up** button to select **Auto Synchronization**.
5. Press the **Left** or **Right** button to turn **Auto Synchronization Off**.
6. Press the **Down** or **Up** button to select **Date** or **Time**.
7. Use the **Left** or **Right** button to select the variable that you want to change and use number buttons to enter the date or time.
8. Press the **MENU** button to return to the previous menu.

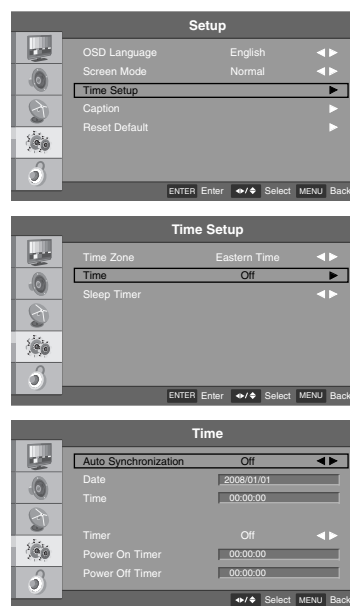

Chapter 6: Using the TV's Features

Auto On /Off Time Settings

The timer function will only operate when the current time has been set. This function automatically turns the TV On and Off at the specific time you designate.

1. Press the **MENU** button to enter the on-screen menu and then press either the **Down** or **Up** button in order to select the **Setup** sub-menu.
2. Press the **OK** button to enter the submenu and then press either the **Down** or **Up** button in order to select **Time Setup**.
3. Press the **OK** button and then press the **Down** or **Up** button to select **Time**.
4. Press the **OK** button and then press the **Down** or **Up** button to select **Timer**.
5. Press the **Left** or **Right** button to select **On**. If **Timer** is selected to **Off**, **Power On Timer** and **Power Off Timer** menu are cannot be adjusted.
6. Press the **Down** or **Up** button to select **Power On Timer** or **Power Off Timer**.
7. Press the **Left** or **Right** button to move to the desired variable and use number buttons to set time.
8. Press the **MENU** button to return to the previous menu.

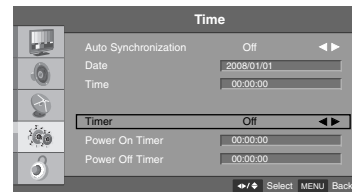
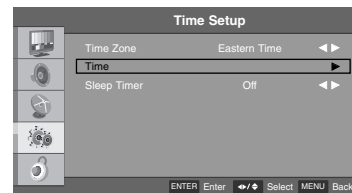
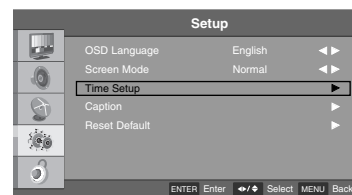

Chapter 6: Using the TV's Features

Sleep Timer

The sleep timer automatically switches the set to standby after the preset time elapses.

1. Press the **MENU** button to enter the on-screen menu and then press either the **Down** or **Up** button in order to select the **Setup** sub-menu.
2. Press the **OK** button to enter the submenu and then press either the **Down** or **Up** button in order to select **Time Setup**.
3. Press the **OK** button and then press the **Down** or **Up** button to select **Sleep Timer**.
4. Press the **Left** or **Right** button to select desired sleep time.
The timer begins to count down from the number of minutes selected and will switch the unit to standby when the time runs out.
5. Press the **MENU** button to return to the previous menu.



Note

- If you want to select directly select the sleep timer without entering the menus, press the **SLEEP** button on the remote control.
- Every time you press the button, it will switch between **Off, 10, 20, 30, 40, 50, 60, 90** and **120**.

Chapter 6: Using the TV's Features

Captions

Closed Caption - Analog

The Analog Caption function operates when watching a regular analog channel.

1. Press the **MENU** button to enter the on-screen menu and then press either the **Down** or **Up** button in order to select the **Setup** sub-menu.
2. Press the **OK** button to enter the submenu and then press either the **Down** or **Up** button in order to select **Caption**.
3. Press the **OK** button and then press the **Down** or **Up** button to select **Analog Closed Caption**.
4. Press the **Left** or **Right** button to select between **Off**, **CC1**, **CC2**, **CC3**, **CC4**, **TEXT1**, **TEXT2**, **TEXT3** or **TEXT4**.
5. Press the **MENU** button to return to the previous menu.

- **Caption**

The term for the words that scroll across the bottom of the TV screen; usually the audio portion of the program provided for the hearing impaired.

- **TEXT**

The term for the words that appear in a large black-frame and almost cover the entire screen; usually messages provided by the broadcaster.

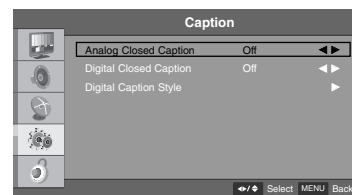
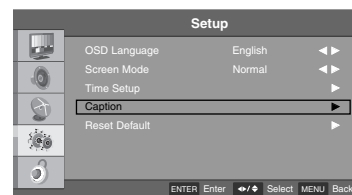

Note

- If you want to select directly the Closed Captions, press the **CC** button on the remote control.

Chapter 6: Using the TV's Features

Closed Caption - Digital

The Digital Caption function only operates on digital channels.

1. Press the **MENU** button to enter the on-screen menu and then press either the **Down** or **Up** button in order to select the **Setup** sub-menu.
2. Press the **OK** button to enter the submenu and then press either the **Down** or **Up** button in order to select **Caption**.
3. Press the **OK** button and then press the **Down** or **Up** button to select **Digital Closed Caption**.
4. Press the **Left** or **Right** button to select between **Off**, **Service1**, **Service2**, **Service3**, **Service4**, **Service5** or **Service6**.
5. Press the **MENU** button to return to the previous menu.

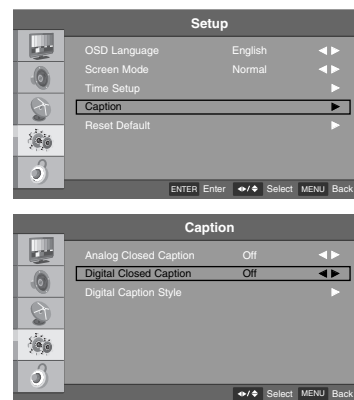

Chapter 6: Using the TV's Features

Digital Closed Caption Options

Customize the DTV captions that appear on your screen.

1. Press the **MENU** button to enter the on-screen menu and then press either the **Down** or **Up** button in order to select the **Setup** sub-menu.
2. Press the **OK** button to enter the submenu and then press either the **Down** or **Up** button in order to select **Caption**.
3. Press the **OK** button and then press the **Down** or **Up** button to select **Digital Caption Style**.
4. Press the **OK** button and then press the **Down** or **Up** button to select **Caption Style**.
5. Press the **Left** or **Right** button to select **Custom**.
6. Press the **Down** or **Up** button to select desired caption option you wish to change. (Select between: **Font Size**, **Font Color**, **Font Opacity**, **Background Color**, **Background Opacity**, **Window Color**, **Window Opacity**)
7. Press the **Left** or **Right** button to customize your selected preference.
8. Press the **MENU** button to return to the previous menu.

- **Font Size**
Set the size in which the captions will appear in.
- **Font Color**
Set the color in which the captions will appear in.
- **Font Opacity**
Select the transparency for the captions.

- **Background Color**
Select a background color for the captions.
- **Background Opacity**
Select the transparency for the background.
- **Window Color**
Select a color for the edges.
- **Window Opacity**
Select the transparency for the edges.

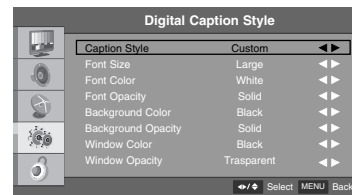
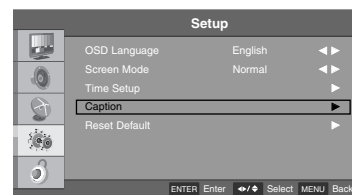

Note

- If the Caption Style is selected to "**As Broadcaster**", the Caption Options cannot be adjusted.

Chapter 6: Using the TV's Features

Reset

Reset Default

This function returns all of the menu selections back to their original factory preset values. This function removes all TV channels from memory. Channels must be scanned for again after resetting to the unit to factory defaults.

1. Press the **MENU** button to enter the on-screen menu and then press either the **Down** or **Up** button in order to select the **Setup** sub-menu.
2. Press the **OK** button to enter the submenu and then press either the **Down** or **Up** button in order to select **Reset Default**.
3. Press the **OK** button and then press the **Left** or **Right** button to highlight the **OK** button.
4. Press the **OK** button on the remote control to reset all settings.
5. Press the **MENU** button to return to the previous menu.



Chapter 6: Using the TV's Features

Parental Control

Entering your password

Parental Control can be used to block specific channels, ratings and other viewing sources.

The default password of 0-0-0-0 is required to gain access to this menu.

1. Press the **MENU** button to enter the on-screen menu and then press either the **Down** or **Up** button in order to select the **Parental** sub-menu.
2. Press the **OK** button and then enter the default password as requested.
3. The TV is set up with the initial password of "0-0-0-0".

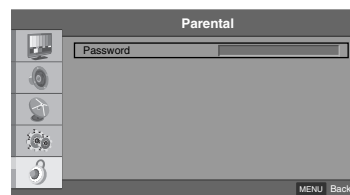

Set Password

This option will allow you to input a new password of your choice.

1. After entering the parental sub-menu, press the **Down** or **Up** button to select **Change Password**.
2. Press the **OK** button and then select any 4 digits for your new password and enter them in the **New Password** section.
3. As soon as the 4 digits are entered, re-enter the same 4 digits on the **Confirm Password** to finalize your selection.
4. Your new password has now been memorized.
5. Press the **MENU** button to return to the previous menu.



Note

- Write down your new password and keep it somewhere safe for the case of forgetting it in the future.

Chapter 6: Using the TV's Features

Ratings - Enable / Disable

Enables or disables a parental blocking scheme.

1. After entering the **Parental** sub-menu, press the **Down** or **Up** button to choose **Program Block**.
2. Press the **OK** button and then press the **Down** or **Up** button to select **Rating Enable**.
3. Press the **Left** or **Right** button to select **On** or **Off**.
When you select **On**, the Program Block options are enabled.
4. Press the **MENU** button to return to the previous menu or scroll down to edit a Program Block option.

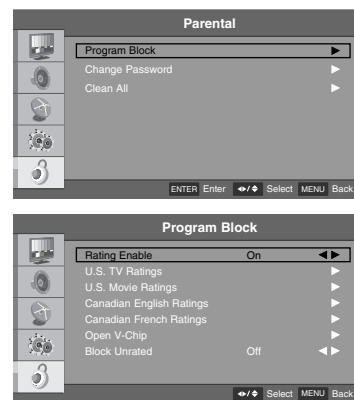

Chapter 6: Using the TV's Features

TV Ratings for USA

This rating system has been established to help you monitor and block the types of programs viewed on TV. Ratings with a lock next to them will be blocked from being viewed.

1. After entering the **Parental** sub-menu, press the **Down** or **Up** button to choose **Program Block**.
2. Press the **OK** button and then press either the **Down** or **Up** button to select **U.S.TV Ratings**.
3. Press the **OK** button to enter the sub-menu.
4. Use the **Down, Up, Left** or **Right** buttons to highlight the selection you wish to block and press the **OK** button to block that selection.
(Note: See rating descriptions on the next page.)
5. Press the **MENU** button to return to the previous menu.

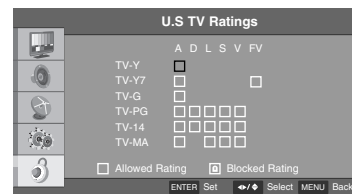
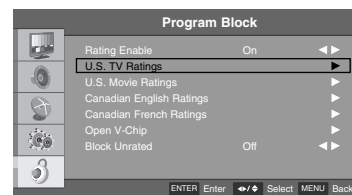
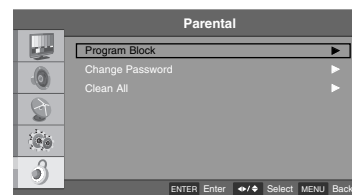

Chapter 6: Using the TV's Features

TV (FCC) Age Categories

- **TV-MA**
Mature audiences only.
This program may contain mature themes, profane language, graphic violence and explicit sexual content.
- **TV-14**
Parents strongly cautioned.
This program may contain sophisticated themes, sexual content, strong language and more intense violence.
- **TV-PG**
Parental guidance suggested.
The program may contain infrequent coarse language, limited violence, some suggestive sexual dialog and situations.
- **TV-G**
General audience.
This contains little or no violence, no strong language, and little or no sexual dialog or situations.
- **TV-Y7**
Directed for older children.
Themes and elements in this program may include mild physical or comedic violence, or may frighten children under the age of seven.
- **TV-Y**
All children.
The themes and elements in this program are specifically designed for a very young audience, including children from ages two – six.

TV (FCC) Content Sub-Categories:

- **D:** Dialog...sexual innuendo.
- **L:** Offensive language.
- **S:** Sexual Situation
- **V:** Violence.
- **FV:** Fantasy or cartoon violence.

Chapter 6: Using the TV's Features

Movie Ratings

This rating system has been established to help you monitor and block the types of movies viewed. These ratings apply to movies broadcasted on TV and allows you to select which ratings you want blocked.

1. After entering the **Parental** sub-menu, press the **Down** or **Up** button to choose **Program Block**.
2. Press the **OK** button and then press either the **Down** or **Up** button to select **U.S. Movie Ratings**.
3. Press the **OK** button to enter the submenu.
4. Press the **Down** or **Up** buttons to choose the rating you wish to block and press the **OK** button to block that selection. (See rating descriptions below)
5. Press the **MENU** button to return to the previous menu.

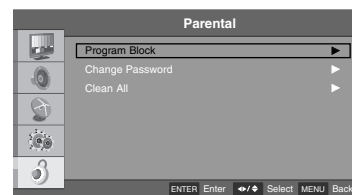

The MPAA Rating System (Movies)

- **G**
General Audience.
- **PG**
Parental guidance suggested.
- **PG-13**
Parents strongly cautioned.
- **R**
Restricted.
- **NC-17**
No one 17 and under admitted.
- **X**
Adults only.

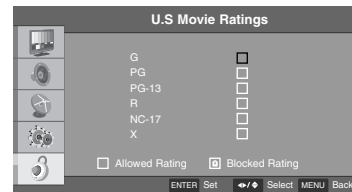

Note

- If you block PG-13, G and PG movies will be available, PG-13, R, NC-17 and X will be blocked.

Chapter 6: Using the TV's Features

English TV Ratings for Canada

This rating system has been established to help you monitor and block the types of programs viewed on TV. Ratings with a lock next to them will be blocked from being viewed.

1. After entering the **Parental** sub-menu, press the **Down** or **Up** button to choose **Program Block**.
2. Press the **OK** button and then press the **Down** or **Up** button to select **Canadian English Ratings**.
3. Press the **OK** button to enter the sub-menu.
4. Press the **Down** or **Up** buttons to choose the selection you wish to block and press the **OK** button on the remote to block it. (See rating descriptions below)
5. Press the **MENU** button to return to the previous menu.

Canadian English Ratings

- **C**
Children
- **C8+**
Children eight years and older
- **G**
General programming, suitable for all audiences
- **PG**
Parental Guidance
- **14+**
Viewers 14 years and older
- **18+**
Adult programming

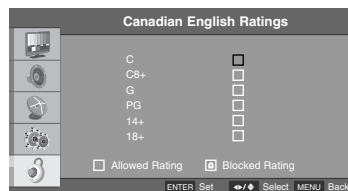
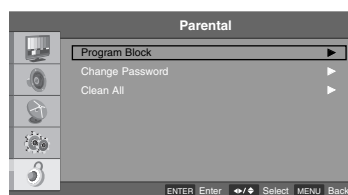

Chapter 6: Using the TV's Features

French TV Ratings for Canada

This rating system has been established to help you monitor and block the types of programs viewed on TV. Ratings with a lock next to them will be blocked from being viewed.

1. After entering the **Parental** sub-menu, press the **Down** or **Up** button to choose **Program Block**.
2. Press the **OK** button and then press the **Down** or **Up** button to select **Canadian French Ratings**.
3. Press the **OK** button to enter the sub-menu.
4. Press the **Down** or **Up** buttons to choose the selection you wish to block and press the **OK** button on the remote to block it. (See rating descriptions below)
5. Press the **MENU** button to return to the previous menu.

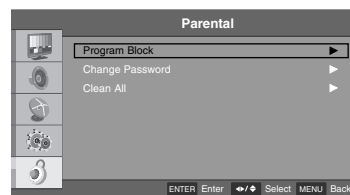

Canadian French Ratings

- **G**
General
- **8 ans+**
General-Not convenient for little children
- **13 ans+**
Not convenient for children of 13 years and younger
- **16 ans+**
Not convenient for children of 16 years and younger
- **18 ans+**
This programs is only for adult

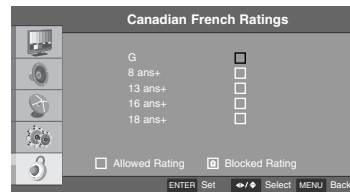

Chapter 6: Using the TV's Features

Downloadable Rating

Your TV's OSD (On Screen Display) may differ slightly from what is shown in this manual.

1. After entering the **Parental** sub-menu, press the **Down** or **Up** button to choose **Program Block**.
2. Press the **OK** button and then press the **Down** or **Up** button to select **Open V-Chip**.
3. Press the **OK** button twice.
4. Press the **Down** or **Up** buttons to choose the menu options for **Open V-Chip**.
5. Press the **OK** button to make your selection.
6. Press the **MENU** button to return to the previous menu.



Note

- This function may become available in the future and will be available only for digital channel signal.
- This function operates only when TV has received Region5 Rating data.

Chapter 6: Using the TV's Features

Block Unrated

Block Unrated can be used to block unrated channels, ratings and other viewing sources.

1. After entering the **Parental** sub-menu, press the **Down** or **Up** button to choose **Program Block**.
2. Press the **OK** button and then press the **Down** or **Up** button to select **Block Unrated**.
3. Press the **Left** or **Right** button to select **On** or **Off**.
4. Press the **MENU** button to return to the previous menu.



Clean All

This function cleans and resets all current parental block settings.

1. After entering the **Parental** sub-menu, press the **Down** or **Up** button to choose **Clean All**.
2. Press the **OK** button on the remote control to select **Clean All** and then press the **Left** or **Right** button to select **OK** button.
3. Press the **OK** button to clean and reset the **Program Block** menu options.
4. Press the **MENU** button to return to the previous menu.

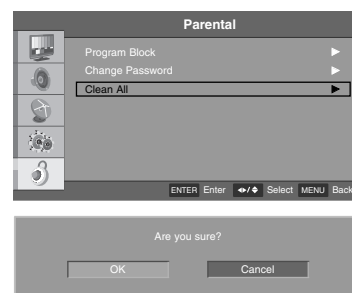

Chapter 6: Using the TV's Features

Setting the PC Mode

Automatic Screen Adjustment

This function automatically adjusts the screen position, clock, phase and scale in pc mode. The displayed image will disappear for a few seconds while the auto configuration is in progress. If the result of the automatic adjustment is not correct, you can manually adjust the settings to fit your viewing preference.

1. Press the **MENU** button to enter the on-screen menu and then press either the **Down** or **Up** button to select the **Video** sub-menu.
2. Press the **OK** button to enter the sub-menu and then press either the **Down** or **Up** button to select **VGA**.
3. Press the **OK** button and then use the **Down** or **Up** button to select **Auto Adjust**.
4. Press the **OK** button to start the auto adjustment.
5. If the result of the automatic adjustment is not correct, you can manually adjust the settings to fit your viewing preference. (See the next page for manual adjustment settings.)

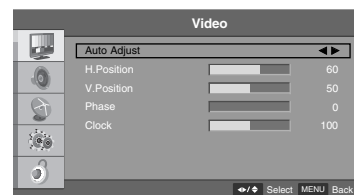

Note

- Select the **VGA** mode by pressing either the **INPUT** button.

Chapter 6: Using the TV's Features

Manual Screen Adjustment

If the result of the automatic adjustment is not correct, you can manually adjust the settings to fit your viewing preference.

1. Press the **MENU** button to enter the on-screen menu and then press either the **Down** or **Up** button to select the **Video** sub-menu.
2. Press the **OK** button to enter the sub-menu and then press either the **Down** or **Up** button to select **VGA**.
3. Press the **OK** button and then press the **Down** or **Up** button to select video option you wish to change.
4. Press the **OK** button and then press the **Left** or **Right** button to make appropriate adjustments.
5. Press the **MENU** button to return to the previous menu.

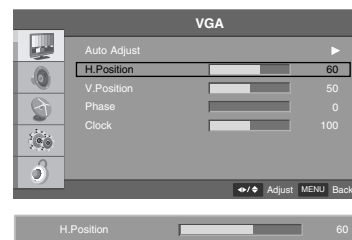

- **Horizontal Position**
This function is to adjust horizontal position of screen.
- **Vertical Position**
This function is to adjust vertical position of screen.
- **Phase**
This function allows you to remove any horizontal noise and clear or sharpen the image of characters.
- **Clock**
This function is to minimize any vertical bars or stripes visible on the screen background. And the horizontal screen size will also change.

Chapter 6: Using the TV's Features

USB Functions

Picture Function

To view photos, insert a USB device containing image files. Select the **USB** mode by pressing the **INPUT** button.

1. Press the **Left** or **Right** button to select **Picture**.
2. Press the **OK** button twice to move to picture list of USB device.
3. Press the **Left**, **Right**, **Up** or **Down** button to select picture that want to view.
4. Press the **OK** button to display selected picture. The slideshow will start in the order from the selected picture.

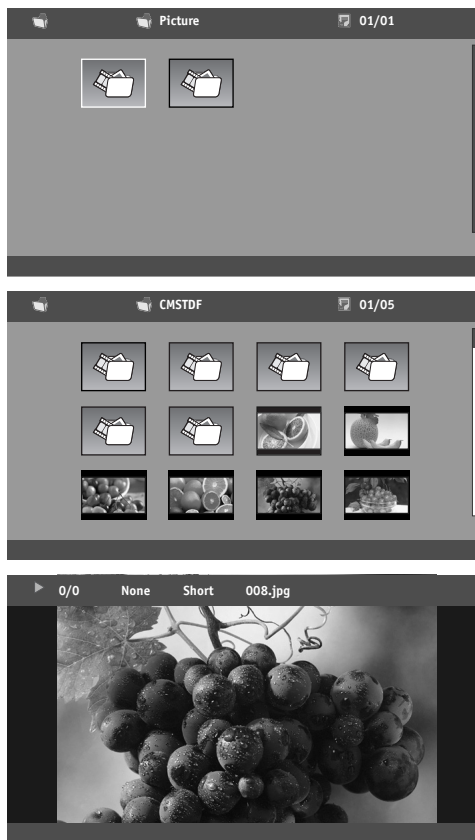

Chapter 6: Using the TV's Features

Music Function

To listen music, insert a USB device containing music files. Select the **USB** mode by pressing the **INPUT** button.

1. Press the **Left** or **Right** button to select **Music**.
2. Press the **OK** button twice to move to music list of USB device.
3. Press the **Left, Right, Up** or **Down** button to select music that want to listen.
4. Press the **OK** button to play selected music. The music will play in the order from the selected music.

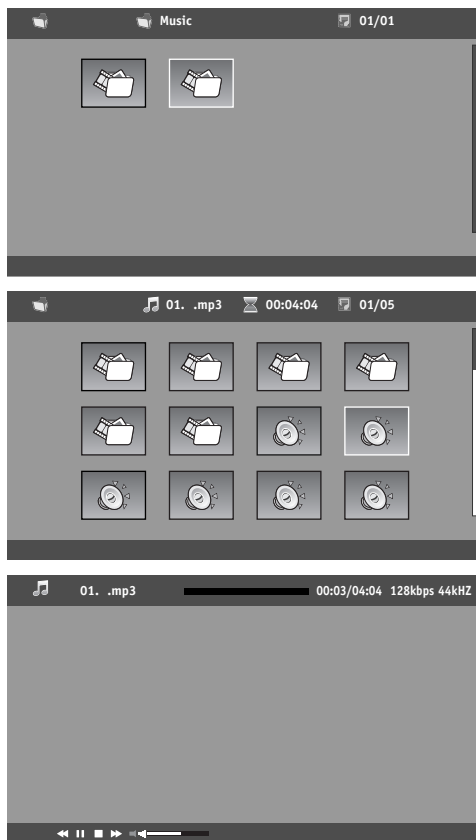

Chapter 6: Using the TV's Features

Specifications

Models	J22C760	
Dimension (Width x Height x Depth)	529.5mm x 397.5mm x 84.0mm 20.85 x 15.65 x 3.31 inches	
Weight (kg / lbs)	5.7 kg / 12.57 lbs	
Brightness	J22C760-FA2 (200cd/m ²) J22C760-FP2 (200cd/m ²)	J22C760-FA4 (250cd/m ²) J22C760-FP4 (250cd/m ²)
Panel Resolution	1680 (H) x 1050 (V)	
Power Rating	AC100-240V~ 50/60Hz	
Consumption	60W	
Audio Output	2.5W + 2.5W	
Contrast Ratio	1,000:1	
Accessories	<ul style="list-style-type: none"> • Power Cord • Owner's Manual 	<ul style="list-style-type: none"> • Stand
External Port	<ul style="list-style-type: none"> • HDMI/DVI IN • RGB IN(PC) • COMPONENT IN • AV1 • AV2 • AUDIO IN (RGB / DVI) 	<ul style="list-style-type: none"> • ANTENNA / CABLE IN • USB IN • DIGITAL AUDIO OUT (COAXIAL) • AC IN • SERVICE • H/P

• The Specification shown above may be changed without notice.

Chapter 6: Using the TV's Features

Models	J26C700	
Dimension (Width x Height x Depth)	686.0mm x 504.0mm x 103.5mm 27.01 x 19.84 x 4.07 inches	
Weight (kg / lbs)	9.1 kg / 20.06 lbs	
Brightness	J26C700-HA4 (360cd/m ²) J26C700-HP4 (360cd/m ²)	J26C700-FA4 (320cd/m ²) J26C700-FP4 (320cd/m ²)
Panel Resolution	1366 (H) x 768 (V)	1920 (H) x 1080 (V)
Power Rating	AC100-240V~ 50/60Hz	
Consumption	100W	
Audio Output	3W + 3W	
Contrast Ratio	1,000:1	
Accessories	<ul style="list-style-type: none"> • Power Cord • Owner's Manual 	<ul style="list-style-type: none"> • Stand
External Port	<ul style="list-style-type: none"> • HDMI/DVI IN • RGB IN(PC) • COMPONENT IN • AV1 • AV2 • AUDIO IN (RGB / DVI) 	<ul style="list-style-type: none"> • ANTENNA / CABLE IN • USB IN • DIGITAL AUDIO OUT (COAXIAL) • AC IN • SERVICE

- The Specification shown above may be changed without notice.

Chapter 6: Using the TV's Features

Models	J32C750
Dimension (Width x Height x Depth)	814.0mm x 574.0mm x 106.5mm 32.05 x 22.60 x 4.19 inches
Weight (kg / lbs)	11.9 kg / 26.23 lbs
Brightness	400 cd/m ²
Panel Resolution	1366 (H) x 768 (V)
Power Rating	AC100-240V~ 50/60Hz
Consumption	135W
Audio Output	3W + 3W
Contrast Ratio	1,100:1
Accessories	<ul style="list-style-type: none"> <li style="width: 50%;">• Power Cord <li style="width: 50%;">• Stand <li style="width: 50%;">• Owner's Manual
External Port	<ul style="list-style-type: none"> <li style="width: 50%;">• HDMI/DVI IN <li style="width: 50%;">• ANTENNA / CABLE IN <li style="width: 50%;">• RGB IN(PC) <li style="width: 50%;">• USB IN <li style="width: 50%;">• COMPONENT IN <li style="width: 50%;">• DIGITAL AUDIO OUT (COAXIAL) <li style="width: 50%;">• AV1 <li style="width: 50%;">• AC IN <li style="width: 50%;">• AV2 <li style="width: 50%;">• SERVICE <li style="width: 50%;">• AUDIO IN (RGB / DVI)

- The Specification shown above may be changed without notice.

Chapter 6: Using the TV's Features

Models	J42C750
Dimension (Width x Height x Depth)	1021.0mm x 641.0mm x 115.5mm 40.20 x 25.24 x 4.55 inches
Weight (kg / lbs)	20.0 kg / 44.09 lbs
Brightness	400 cd/m ²
Panel Resolution	1920 (H) x 1080 (V)
Power Rating	AC100-240V~ 50/60Hz
Consumption	195W
Audio Output	5W + 5W
Contrast Ratio	1,300:1
Accessories	<ul style="list-style-type: none"> • Power Cord • Stand • Owner's Manual
External Port	<ul style="list-style-type: none"> • HDMI/DVI IN • ANTENNA / CABLE IN • RGB IN(PC) • USB IN • COMPONENT IN • DIGITAL AUDIO OUT (COAXIAL) • AV1 • AC IN • AV2 • SERVICE • AUDIO IN (RGB / DVI)

- The Specification shown above may be changed without notice.

Chapter 7: Other Information

Troubleshooting

Problem	Check Point
No picture on screen.	<ul style="list-style-type: none">• Check whether the set is turned on.• Power cord inserted into wall outlet?• Test if there is power coming from the wall outlet by plugging in another product into the wall outlet where the set's power cord was plugged in.
The remote control doesn't work.	<ul style="list-style-type: none">• Ensure remote is enabled in Commercial Interface menu.• Ensure TV1/TV2 settings of TV match the remote.
Picture appears slowly, after switching on.	<ul style="list-style-type: none">• This is normal as the image is muted during the start up process of the set. Please contact your service center, if the picture has not appeared after five minutes.
No or Poor color	<ul style="list-style-type: none">• Select color in the Picture menu and press the Left or Right button.
Horizontal/Vertical bars or picture shaking	<ul style="list-style-type: none">• Check for local interference such as a nearby electrical appliance or power tool.
Unusual sound from inside the set.	<ul style="list-style-type: none">• A change in ambient humidity or temperature may result in an unusual noise at the time of switching off or on of the set and does not indicate a fault with the set.

Chapter 7: Other Information

Limited Warranty

Your Display will be repaired or replaced in accordance with the terms of this warranty, if it proves to be defective in material or workmanship under normal use, during the warranty period ("Warranty Period") listed below, effective from the date ("Date of Purchase") of original consumer purchase of the product. This warranty is good only to the original purchaser of the product and effective only when used in the United States, excluding U.S. Territories.

WARRANTY PERIOD

Labor and parts: 2 years from the Date of Purchase. Your unit will be repaired or replaced with a new, substitute model or factory reconditioned unit. If repaired, parts used in the repair may be new or remanufactured.

Replacement Units and Repair Parts are warranted for the remaining portion of the original unit's warranty period.

Effective date of warranty:

Your warranty period begins on the date of sale to the original consumer/end user. KEEP THE DEALER'S DATED BILL OF SALE OR PROOF OF DELIVERY as evidence of the purchase date.

You will be required to submit a legible copy of your bill of sale or proof of delivery when requesting warranty service.

THIS WARRANTY IS IN LIEU OF ANY OTHER WARRANTY, EXPRESS OR IMPLIED, INCLUDING WITHOUT LIMITATION, ANY WARRANTY OF MERCHANTABILITY OR FITNESS FOR A PARTICULAR PURPOSE. TO THE EXTENT ANY IMPLIED WARRANTY IS REQUIRED BY LAW, IT IS LIMITED IN DURATION TO THE EXPRESS WARRANTY PERIOD ABOVE. NEITHER THE MANUFACTURER NOR ITS U.S. DISTRIBUTOR SHALL BE LIABLE FOR ANY INCIDENTAL, CONSEQUENTIAL, INDIRECT, SPECIAL, OR PUNITIVE DAMAGES OF ANY NATURE, INCLUDING WITHOUT LIMITATION, LOST PROFITS, LOST OR CORRUPTED PROGRAMMING OR DATA, OR ANY OTHER DAMAGE WHETHER BASED IN CONTRACT, TORT, OR OTHERWISE.

Some states do not allow the exclusion or limitation of incidental or consequential damages or limitations on how long an implied warranty lasts, so the above exclusion or limitation may not apply to you. This warranty gives you specific legal rights and you may also have other rights that vary from state to state.

Concerning Pixel Functionality:

Your display contains about one million individual pixels.

Your display typically contain a small number of pixels that do not function normally. Your display has been inspected and is in compliance with manufacturer's specifications, indicating that any pixel defects do not effect the operation or use of your display.

Chapter 7: Other Information

THIS LIMITED WARRANTY DOES NOT APPLY TO:

- Damage caused in shipping or transit
- Service required as a result of improper installation, including incorrect or insufficient AC supply (please consult the owner's manual for power supply requirements).
- Installation or repair of antenna systems, cable converters, cable company supplied equipment, or other components in a video system
- Set-up or adjustment on consumer controls, or damage caused by improper adjustments
- Damage caused by other system components
- Any panel that has been modified or incorporated into any other product
- Replacement of batteries on the remote control.
- Damage (including cosmetic damage), failure, loss or personal injury due to misuse, abuse, negligence, improper maintenance or storage, or to acts of nature or other causes beyond our control. (Causes beyond our control include but are not limited to lightning strike, power surges, power outages and water damage.)
- Image burn-in
- Repair or replacement of warranted parts by anyone other than an authorized service centers.
- Units purchased or serviced outside of the coverage area.
- Product where the original factory serial numbers have been removed, defaced or changed in any way.
- Product sold and labeled as "as is, where is" or similar disclaimer.

How you get service:

- Contact your dealer, or visit <http://service.rcacommercialtv.com>, or call 800-RCA-2161.
- Proof of purchase in the form of a bill of sale or receipted invoice which is evidence that the product is within the warranty period must be presented to obtain warranty service. For rental firms, proof of first rental is also required.
- To contact the RCA Commercial warranty center by E-mail : service@rcacommercialtv.com

Product Registration:

- Please complete and mail the Product Registration Card packed with your TV or register online at <http://service.rcacommercialtv.com>. It will make it easier to contact you should it ever be necessary. The return of the card is not required for warranty coverage.

Care and Cleaning

CAUTION: Turn OFF your TV before cleaning.

You can clean the TV as required, using a dry cloth. Be sure to occasionally dust the ventilation slots in the cabinet to help assure adequate ventilation.

IMPORTANT: Do not allow liquid to come in contact with the TV, or allow liquid to run down the screen and inside the TV. Also, never place drinks or vases with water on top of the TV. This could increase the risk of fire or shock hazard or damage to the TV. Never use cleaning agents, they will damage the TV.

CHILD SAFETY:

It Makes A Difference How and Where
You Use Your Flat Panel Display

Congratulations on your purchase! As you enjoy your new product, please keep these safety tips in mind:



THE ISSUE

- The home theater entertainment experience is a growing trend and larger flat panel displays are popular purchases. However, flat panel displays are not always supported on the proper stands or installed according to the manufacturer's recommendations.
- Flat panel displays that are inappropriately situated on dressers, bookcases, shelves, desks, speakers, chests or carts may fall over and cause injury.

THIS MANUFACTURER CARES!

- The consumer electronics industry is committed to making home entertainment enjoyable and safe.

TUNE INTO SAFETY

- One size does NOT fit all. Follow the manufacturer's recommendations for the safe installation and use of your flat panel display.
- Carefully read and understand all enclosed instructions for proper use of this product.
- Don't allow children to climb on or play with furniture and television sets.
- Don't place flat panel displays on furniture that can easily be used as steps, such as a chest of drawers.
- Remember that children can become excited while watching a program, especially on a "larger than life" flat panel display. Care should be taken to place or install the display where it cannot be pushed, pulled over, or knocked down.
- Care should be taken to route all cords and cables connected to the flat panel display so that they cannot be pulled or grabbed by curious children.

WALL MOUNTING: IF YOU DECIDE TO WALL MOUNT YOUR FLAT PANEL DISPLAY, ALWAYS:

- Use a mount that has been recommended by the display manufacturer and/or listed by an independent laboratory (such as UL, CSA, ETL).
- Follow all instructions supplied by the display and wall mount manufacturers.
- If you have any doubts about your ability to safely install your flat panel display, contact your retailer about professional installation.
- Make sure that the wall where you are mounting the display is appropriate. Some wall mounts are not designed to be mounted to walls with steel studs or old cinder block construction. If you are unsure, contact a professional installer.
- A minimum of two people are required for installation. Flat panel displays can be heavy.



 **CEA**
Consumer Electronics Association
www.CE.org/safety

MEMO

MEMO

Visit the RCA website at <http://service.rcacommercialtv.com>

Please do not send any products to the Indianapolis address listed in this manual or on the carton. This will only add delays in service for your product.

DTI

DTI Services, LLC
1416 Miller Ave.
Shelbyville, In 46176

P/NO : 3350GDKM0121A
GPN09MA058L

Free Manuals Download Website

<http://myh66.com>

<http://usermanuals.us>

<http://www.somanuals.com>

<http://www.4manuals.cc>

<http://www.manual-lib.com>

<http://www.404manual.com>

<http://www.luxmanual.com>

<http://aubethermostatmanual.com>

Golf course search by state

<http://golfingnear.com>

Email search by domain

<http://emailbydomain.com>

Auto manuals search

<http://auto.somanuals.com>

TV manuals search

<http://tv.somanuals.com>