

RCA

LCD Television User's Guide

Changing Entertainment. Again.



Important Information

CAUTION

RISK OF ELECTRIC SHOCK
DO NOT OPEN



This symbol indicates that this product incorporates double insulation between hazardous mains voltage and user accessible parts. When servicing use only identical replacement parts.

Caution: To reduce the risk of electric shock, do not remove cover (or back). No user serviceable parts inside. Refer servicing to qualified service personnel.



This symbol indicates "dangerous voltage" inside the product that presents a risk of electric shock or personal injury.



This symbol indicates important instructions accompanying the product.

WARNING

To reduce the risk of fire or electric shock, do not expose this product to rain or moisture. This apparatus shall not be exposed to dripping or splashing. No objects filled with liquids, such as vases, shall be placed on the apparatus.

Refer to the identification/rating label located on the back panel of your product for its proper operating voltage.

FCC Regulations state that unauthorized changes or modifications to this equipment may void the user's authority to operate it.

Caution: Using video games or any external accessory with fixed images for extended periods of time can cause them to be permanently imprinted on the picture tube (or projection TV picture tubes). ALSO, some network/program logos, phone numbers, black borders (sides, top and bottom), etc. may cause similar damage. This damage is not covered by your warranty.

Cable TV Installer: This reminder is provided to call your attention to Article 820-40 of the National Electrical Code (Section 54 of the Canadian Electrical Code, Part 1) which provides guidelines for proper grounding and, in particular, specifies that the cable ground shall be connected to the grounding system of the building as close to the point of cable entry as practical.

Product Registration

Please fill out the product registration card (packed separately) and return it immediately. For US customers: Your RCA Consumer Electronics product may also be registered at www.rca.com/television. Registering this product allows us to contact you if needed.

Product Information

Keep your sales receipt to obtain warranty parts and service and for proof of purchase. Attach it here and record the serial and model numbers in case you need them. These numbers are located on the product.

Model No. _____

Serial No. _____

Purchase Date: _____

Dealer/Address/Phone: _____

IMPORTANT SAFETY INSTRUCTIONS

Read before operating equipment

1. Read these instructions.
2. Keep these instructions.
3. Heed all warnings.
4. Follow all instructions.
5. Do not use this apparatus near water.
6. Clean only with dry cloth.
7. Do not block any ventilation openings. Install in accordance with the manufacturer's instructions.
8. Do not install near any heat sources such as radiators, heat registers, stoves, or other apparatus (including amplifiers) that produce heat.
9. Do not defeat the safety purpose of the polarized or grounding-type plug. A polarized plug has two blades with one wider than the other. A grounding type plug has two blades and a third grounding prong. The wide blade or the third prong is provided for your safety. If the provided plug does not fit into your outlet, consult an electrician for replacement of the obsolete outlet.
10. Protect the power cord from being walked on or pinched particularly at plugs, convenience receptacles, and the point where they exit from the apparatus.
11. Only use attachments/accessories specified by the manufacturer.
12. Use only with the cart, stand, tripod, bracket, or table specified by the manufacturer, or sold with the apparatus. When a cart is used, use caution when moving the cart/ apparatus combination to avoid injury from tip-over.
13. Unplug this apparatus during lightning storms or when unused for long periods of time.
14. Refer all servicing to qualified service personnel. Servicing is required when the apparatus has been damaged in any way, such as power-supply cord or plug is damaged, liquid has been spilled or objects have fallen into the apparatus, the apparatus has been exposed to rain or moisture, does not operate normally, or has been dropped.

15. If an outside antenna or cable system is connected to the product, be sure the antenna or cable system is grounded so as to provide some protection against voltage surges and built-up static charges. Section 810 of the National Electrical Code, ANSI/NFPA No. 70-1984 (Section 54 of Canadian Electrical Code, Part 1) provides information with respect to proper grounding of the mast and supporting structure, grounding of the lead-in wire to an antenna-discharge unit, size of grounding conductors, location of antenna-discharge unit, connection to grounding electrodes, and requirements for the grounding electrode. See following example.

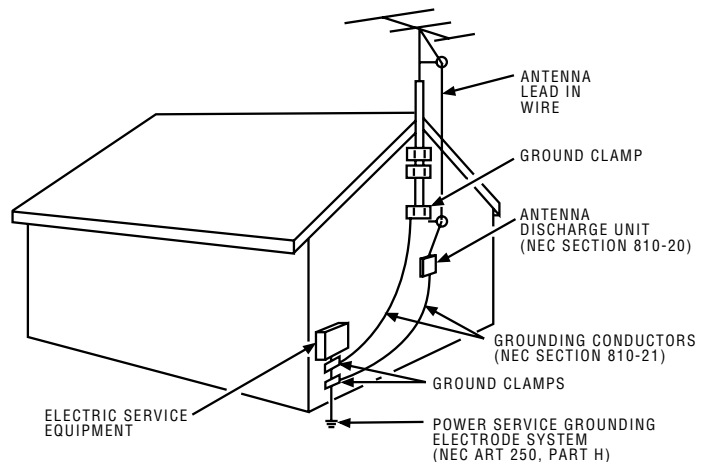

Table of Contents

Important Information	2	Chapter 3: Using the Menu System	
IMPORTANT SAFETY INSTRUCTIONS	3	The Basic Menu System	16
Chapter 1: Connections & Setup		Sound Menu	16
Things to Consider Before You Connect.....	5	Picture Menu	16
Protect Against Power Surges	5	Access and Power Options Menu	16
Protect Components from Overheating	5	Parental Control Menu	17
Position Cables Properly to Avoid Audio		Time Menu.....	17
Interference	5	Language & CC Menu	18
Use Indirect Light	5	Chapter 4: Using the TV's Features	
Remote Control	5	Channel Banner.....	19
Check Supplied Parts.....	5	Parental Controls and V-Chip	20
Get the Picture	6	How V-Chip Works for USA and Canada	20
Getting Digital Channels.....	6	Lock/Unlock Parental Controls.....	20
Getting Regular (Analog) Channels	6	US V-Chip TV Ratings	21
Rear Jack Panel.....	7	Blocking Age-Based Ratings	21
Hospital Pendant.....	7	Blocking Specific Content Themes	22
Start-up.....	7	Blocking Canadian V-Chip Ratings	22
Plug in the TV	7	V-Chip Movie Rating Limit.....	23
Put Batteries in the Remote.....	7	Blocking Movie Ratings.....	23
Turn on the TV	7	Block Channels.....	23
Place All Available Channels Into Memory	7	Block Digital Channels	23
Set the Time	8	Front Panel Lock.....	23
The ClonePRO™	8	Lock Time Menu	24
Understanding the Menus	8	Blocking Unrated/Exempt Programs	24
Master Menus.....	8	Future Rating Region	24
Basic Menus	8	Additional Features	24
Using Master and Basic Menus.....	9	Calendar.....	24
Setting Limits in Master Menus	9	Screen Formats	25
Sound Menu	9	Chapter 5: Other Information	
Access and Power Options Menu	10	Frequently Asked Questions (FAQs).....	26
What to Expect.....	11	Using the ClonePRO™	27
Watching TV	11	Modes of operation	27
Changing Channels	11	DSCI mode.....	27
Explanation of Jacks	12	IR mode.....	28
Buttons and Other Jacks on your TV	13	Cloning a TV	29
Chapter 2: Using the Remote Control		ClonePro Troubleshooting.....	29
Types of Remote Controls	14	Troubleshooting.....	30
Master Remotes.....	14	Mounting Your TV to the Wall.....	32
Basic Remotes	14	V-Chip Rating Explanations.....	33
ClonePRO™.....	14	US V-Chip Rating System.....	33
Additional Remote Buttons (R130K2).....	14	Canadian English V-Chip Rating System	33
ClonePRO™ Remote Buttons	15	Canadian French V-Chip Rating System	34
		Autotuning	35
		Limited Warranty	36
		Care and Cleaning.....	37

Things to Consider Before You Connect

Protect Against Power Surges

- Connect all devices before you plug any of their power cords into the wall outlet or power strip. NEVER plug your TV into an outlet that is controlled by a wall switch.
- Turn off the TV and/or device(s) before you connect or disconnect any cables.
- Make sure all antennas and cables are properly grounded. Refer to the Important Safety Instructions at the beginning of the User's Guide.

Protect Devices from Overheating

- Don't block ventilation holes on any of the devices. Arrange the devices so that air can circulate freely.
- Don't stack devices.
- If you place devices in a stand, make sure you allow adequate ventilation.
- If you connect an audio receiver or amplifier, place it on the top shelf so the heated air from it won't flow around other devices.

Position Cables Properly to Avoid Audio Interference

- Insert each cable firmly into the designated jack.
- If you place devices above the TV, route all cables down the side of the back of the TV instead of straight down the middle.
- If your antenna uses 300-ohm twin lead cables, do not coil the cables. Also, keep the twin lead cables away from audio/video cables.

Use Indirect Light

Don't place the TV where sunlight or room lighting will be directed toward the screen. Use soft or indirect lighting.

Remote Control

You will need a master remote or ClonePRO™ to set up the TV. Contact your RCA Commercial Distributor to purchase these.



Remote Control
Part # R130K1

Check Supplied Parts

Check that the following parts were packed with your product.

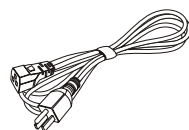

Note: If you need to replace your remote, call 1-800-338-0376. A shipping and handling fee, and the appropriate sales tax, will be charged upon ordering. Have your Visa, MasterCard, or Discover Card ready.

Connections and Setup

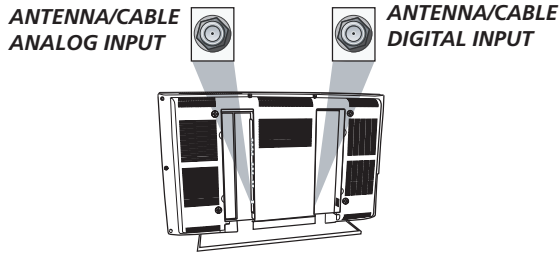

Get the Picture

The first part of connecting your TV is to get the picture, also known as the signal. The back panel of your TV allows you to receive analog channels by using the ANTENNA/CABLE ANALOG INPUT and digital channels by using the ANTENNA/CABLE DIGITAL INPUT. See the graphic to the left for these locations.

Getting Digital Channels

What You Need

- Antenna ("rabbit ears") or outdoor antenna with coaxial cable
- A. Do you have an indoor or outdoor antenna? If not, go to step B. If so, plug the antenna or coaxial cable from the wall outlet into the ANTENNA/CABLE DIGITAL INPUT to receive free off-air local digital channels.
 - B. Do you have a set-top box? If not, go to *Getting Regular (Analog) Channels*. If so, you need to call your cable company or satellite service provider. They'll use special cables to allow you to view digital channels. To view your regular channels, go to *Getting Regular (Analog) Channels Step B*.

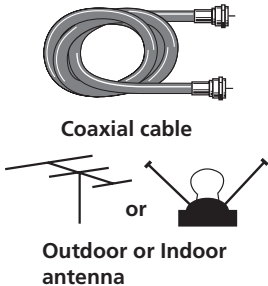

What You Need To Know

- Visit www.antennaweb.org to get help deciding what type of antenna to use to receive the local digital channels available to you. By entering where you live, this mapping program tells you what local analog and digital stations are available using a certain antenna.
- When you get to the *Channel setup* screen in the Initial Setup, make sure you set the options for using a digital signal source. To complete a channel search now, go to page 7.
- When you are ready to watch channels, make sure you are tuned to the Digital Input. Press the ANTENNA button to tune to the Digital Input (look for *D* at the bottom of your channel banner. Go to page 11 for more information).

Getting Regular (Analog) Channels

What You Need

- Antenna ("rabbit ears") or outdoor antenna with coaxial cable
- OR**
- Coaxial cable with cable
- A. Do you have an indoor or outdoor antenna? If not, go to step B. If so, plug the antenna or coaxial cable from the wall outlet into the ANTENNA/CABLE ANALOG INPUT to receive free off-air local analog channels.
 - B. Do you have cable? If so, plug the coaxial cable from the wall outlet into the ANTENNA/CABLE ANALOG INPUT to receive your cable channels.

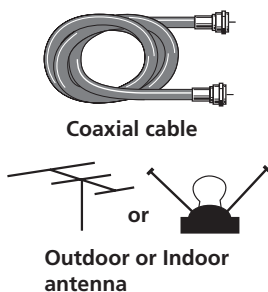

What You Need to Know

- Visit www.antennaweb.org to get help deciding what type of antenna to use to receive the local analog channels available to you. By entering where you live, this mapping program tells you what local analog and digital stations are available using a certain antenna.
- When you get to the *Channel setup* screen in the Initial Setup, make sure you set the options for using an analog signal source. To complete a channel search now, go to page 7.
- When you are ready to watch channels, make sure you are tuned to the Analog Input. Press the ANTENNA button to tune to the Analog Input (look for *A* at the bottom of your channel banner. Go to page 19 for more information).

Rear Jack Panel

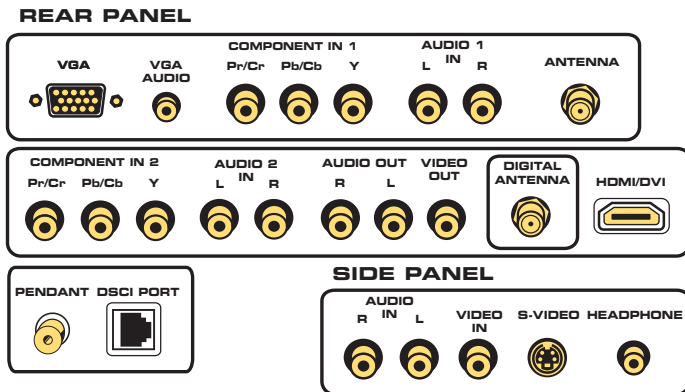

Hospital Pendant

This specialized remote control is recognized for use in patient beds. It is used to connect to a pillow speaker, nurse-call system, or other device to supply speaker-level audio or accept remote control commands. The connector is a (3-wire) phono jack. Some are simple, having one-button operation of the TV; others have enhanced capability for greater control. Specific models and requirements depend on what other devices are in the hospital room, for example, nurse-call systems. See your distributor for more information.

Start-up

Plug in the TV

Plug the end of the power cord into the back of the TV. Plug the other end into a grounded wall outlet. Insert the plug completely into the outlet. Do not plug into an outlet controlled by a light switch.

Put Batteries in the Remote

- Remove the battery compartment cover from the back of the remote by pushing the tab and lifting off the cover.
- Insert two fresh batteries. Make sure the polarities (+ and -) are aligned correctly.
- Replace the cover.

Turn on the TV

Turn on your TV by pressing the Power button on the front of the TV or ON•OFF on the remote control.

Place All Available Channels Into Memory

1. To go to the *Setup* menu, with the master remote (R130K2), press MENU then select *Setup*. In this menu you'll be able to set your *Signal Type*. Next go to *Auto Channel Search*, the TV will search for all channels viewable through your antenna or cable TV system.
2. Select which channel list you'd like to find channels for (*List A* is the default).
3. Press the down arrow button to select *Start*. Press the OK button to start searching. The TV searches for active channels and places them in the channel list.

Note: Video Input Channels (*VID*, *SVID*, etc.) must be added to the active channel list separately before they can be accessed. Refer to the *Setup menu* section at the end of this chapter for more information on the Channel menu and List & Labels.

Connections and Setup

Set the Time

The current time options might not be available to the basic user, depending on how they've been set by the master user. (The Time Configuration menu isn't available in the basic menu).

To set the time, from the Main menu select *Time* then *Time Config*. If the current time has not been set, use the arrow and number buttons on the remote control to make changes.

1. From the Main menu, highlight *Time* and press OK.
2. *Time Config*. is highlighted. Press the right arrow to enter the menu.
3. *Time* is highlighted. To set the time press the right and left arrow button to add or subtract minutes. Use the number buttons to set the hour. The OK button changes *am* and *pm*.

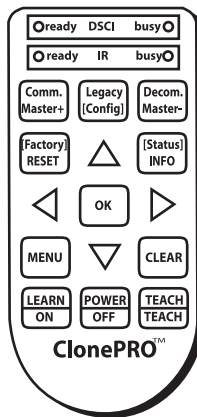

The ClonePRO™

If several TVs need to be programmed with the same menu settings, an optional ClonePRO remote can be used to copy all of the menu settings from one TV into other TVs to reduce installation time. Information can be both downloaded to and uploaded from the ClonePRO using the DSCI port on the TV's back panel or using the IR sensor. A ClonePRO can be obtained from your RCA commercial distributor. Chapter 2 has information about this remote, see page 15. If you want to set other menu options before using the ClonePRO, continue on in this chapter. You can use the ClonePRO at any time.

Understanding the Menus

This television displays two levels of menus: master and basic.

Master Menus

The master menus are accessible by pressing MENU on the master remote (R130K2). This menu shows all menu options. The person who chooses the settings available to the basic end user is called the "master user."

Basic Menus

The basic menus are accessible by pressing MENU on a basic remote (R130K1 or other remote) or the front panel. The choices available on the basic menus and control panels will vary depending on limits set by the master user and the input selected. You can turn off the basic menu completely through the *Access & Power Options* menu. For more information on the effects of master user choices on the basic menu and basic user functionality, continue on in this chapter.

Note: Options set in the master menu are stored in nonvolatile memory. If any options are changed in the basic menu, and then the TV is turned off, the TV defaults to the master menu settings once it's turned back on.



Using Master and Basic Menus

Menus and choice lists use the “point and select” rule to navigate, but control panels use a variety of methods to adjust features on your TV. The following pages detail how to use these controls to customize the functions of your TV.

Press MENU on the remote (master remote for master menu; basic remote for basic menu) or on the front panel (basic menu) to bring up the Main menu.

To select a menu item:

- Navigate with the arrows and then select OK.
- Navigate with the arrows and then select with the right arrow button (unless it's a choice list).

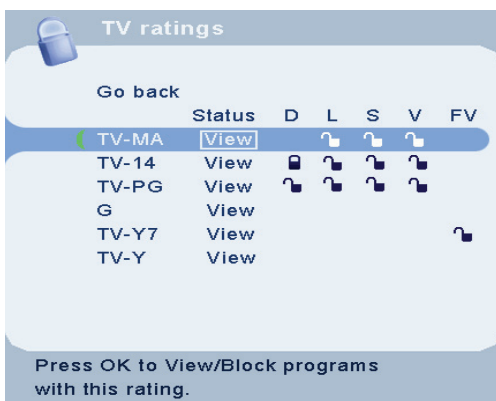

Setting Limits in Master Menus

Some screens in the master menus are not available in the basic menus. There also might be some options you want to make unavailable to the basic user. These next few pages describe these types of menu options. To make all options unavailable, set the basic menus in the *Access & Power Options* menu to *Disabled*. For information on basic menu options, go to Chapter 3.

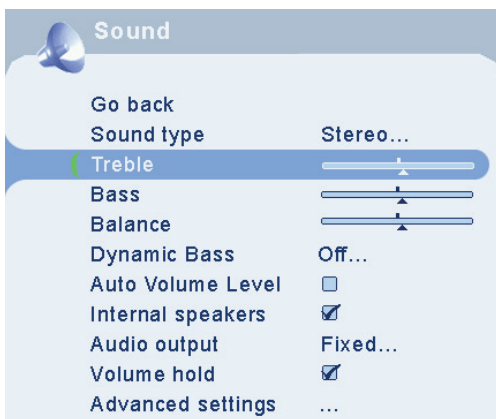

Sound Menu

Initial Volume Sets the TV's volume to the specified level every time it is turned on.

Note: When the DSCI (Digital Serial Communications Interface) port is used to turn the TV on and off, Initial Volume settings are nonfunctional.

Minimum Volume Re-scales the volume control slider so that the far left position is always the minimum allowable volume (but not necessarily the minimum possible volume).

Maximum Volume Re-scales the volume control slider so that the far right position is always the maximum allowable volume (but not necessarily the maximum possible volume).

Access and Power Options Menu

The *Access and Power Options* menu allows the master user to specify which features and functions basic users will be able to access. Scroll to the feature you want to set. Use the right arrow button to change the setting.

Go Back Takes you to the previous menu.

Remote Config. (Configuration) This feature allows the master user to determine which TVs the remote operates. Choose from *TV1*, *TV2*, *TV3*, *TV1&2*, *TV1&3*, *TV2&3*, *All* or *Disabled*. The default setting is *All*. If *Disabled* is chosen, the TV will not respond to the basic remote, except when MENU from the master remote has been pressed.

Note: Although the TV supports TV3, the master remote cannot be programmed for it.

Basic Menus This setting allows you to determine whether the TV's basic menus are accessible. Choose *Enabled* or *Disabled*. When the basic menu is disabled, users cannot access menus through the basic remote or front panel.

TV Power This setting allows you to determine whether the TV can be turned on or off with the POWER button on the remote or the front panel. Choose between:

On Always The TV is always on and cannot be turned off; the Sleep Timer, Schedule and Energy Saver settings are disabled.

Notes: When On Always is being used, KidPass is unavailable.

When the DSCI (Digital Serial Communications Interface) port is used to turn the TV on and off, the On Always setting is overridden.

Switched The TV can be turned on or off; Sleep Timer, Schedule and Energy Saver can be enabled. This is the default setting.

Energy Saver Setting When enabled, this feature turns the TV off after a specified period of inactivity (no remote or front panel button presses). You can toggle between Disabled, 2-hour, 1-hour, and 30-minute settings. Disabled is the default setting. If *TV Power* is set to *On Always*, *Energy Saver* settings are ignored. A warning message will be displayed prior to the TV shutting off.

Front Panel This setting determines whether the front panel buttons are active (able to be used to control the TV) or not.

Parental Control This feature determines the amount of access basic users have to Parental Controls. Blocking age-based rating and content themes is described in Chapter 3. Choose between:

Basic&Pwd (Password) Basic users are able to enter the Parental Control menu and change the password. Basic users can watch blocked programming by entering the system password. This is the default setting.

Basic Basic users are able to enter the Parental Control menu but cannot change the password. Basic users can watch blocked programming by entering the system password.

NoBasic Parental Control does not appear on the basic Main menu. Basic users can watch blocked programming by entering the system password.

If Parental Controls is set to *NoBasic*, Movie Rating Access, TV Rating Access, Unrated Program Block, and Channel Block will not be available to basic users, regardless of what those items have been set to individually in the Parental Controls menu.

Min Stdby Power When enabled, keeps power consumption levels compliant with Energy Star standards. The TV is shipped with this enabled. When enabled, the DSCI and Hospital Pendant (pillow speaker jack) are disabled when power is turned off.

Legacy Mode When turned on, allows the TV to work with earlier DSCI versions. Off is the default setting.

Info Menu Allows the master user to determine whether the Channel Banner is displayed when the INFO button is pressed on the remote. Page 24 shows this display.

Hospital Mode When turned on, allows the TV to function with the hospital pendant remote. For more information about this remote, go to page 24.

Note: When Remote Config. and Front Panel are set to Disabled, the MENU button on the master remote turns on the TV.

What To Expect

Watching TV

- **Remember:** If you have an analog signal connected to your ANTENNA/CABLE ANALOG INPUT, then look for an *A* at the bottom of the screen to make sure you're tuned to the Analog input. Press the ANTENNA button if the *A* isn't appearing.

Analog video is sent in a 4/3 format, which your TV displays these channels in a 16/9 format. Press the LEFT/RIGHT ARROW button to view the different formats available. Go to page 24 for more explanation of screen formats.

- **Remember:** If you have a digital signal connected to your ANTENNA/CABLE DIGITAL INPUT, then look for a *D* at the bottom of the screen to make sure you're tuned to the Digital input. Press the ANTENNA button if the *D* isn't appearing.

Most digital video is sent in a 16/9 format which does fill your screen, but sometimes is sent in 4/3 which does not fill your screen. It depends on how the station or source device is formatting the video. If there are bars on-screen, press the LEFT/RIGHT ARROW button to try a different format that may eliminate the bars. Go to page 24 for more explanation of screen formats.



Look for the *A* at the bottom of the screen to make sure you're on the Analog Input.



Look for the *D* at the bottom of the screen to make sure you're on the Digital Input.

Changing Channels

- Digital channels can have both primary channels (like the analog channel number) and sub-channels. First tune to the Digital Input by pressing the ANTENNA button and look for a *D* at the bottom of the screen. To tune to a digital channel with a sub-channel, enter the primary channel number, then press the right arrow button. Enter the sub-channel number and press OK.
- Depending upon the type of signals you have connected to your HDTV, you might notice that the channels change slower than you're used to. This is perfectly normal. Digital cable channels sometimes take longer to tune.

Explanation of Jacks (in alphabetical order)

This section describes the jacks on the back panel of your TV. There are several ways to connect devices.

ANTENNA/CABLE ANALOG INPUT Lets you connect a coaxial cable to receive the signal from the antenna, cable, or cable box.

ANTENNA/CABLE DIGITAL INPUT Lets you connect a coaxial cable to receive the signal from the antenna, digital cable, or digital cable box.

AUDIO Use the Audio Out jacks when using the MONITOR OUTPUT Video jack or use these jacks by themselves to connect an audio receiver to the TV for enhanced sound quality. If you use these jacks to receive your sound, you don't need to connect the speakers supplied with the TV. Make sure you set the Audio output correctly in the *Advanced Settings Sound* menu. Go to page 28 for more information.

- **L (Audio)** Provides left audio connection. The left audio connector is usually white.
- **R (Audio)** Provides right audio connection. The right audio connector is usually red.

COMPONENT INPUTS Lets you connect a device that has component video jacks, such as a DVD player.

- **CMP1 Y Pb/Cb Pr/Cr (Component Video)** Provides optimum picture quality because the video is separated into three signals. Use three video-grade or component video cables for the connection. When using CMP1 Y Pb/Cb Pr/Cr, make sure you connect left and right audio cables to the CMP1 L and R AUDIO jacks.
- **CMP1 L AUDIO** Provides left audio connection when using the CMP1 video inputs. The left audio connector is usually white.
- **CMP1 R AUDIO** Provides right audio connection when using the CMP1 video inputs. The right audio connector is usually red.
- **CMP2 Y Pb/Cb Pr/Cr (Component Video)** Same as described for CMP1 Y Pb/Cb Pr/Cr and CMP1 Audio above. Make sure you connect the left and right audio cables to the CMP2 L and R AUDIO jacks.

DSCI PORT This port is used to transfer information between a TV and other devices, such as a clone box or interactive system. This port is an eight-pin telephone-type port. When the TV receives a message via the DSCI (digital serial communications interface) port, it will act in accordance with the digital instructions received. For more information on its connection and operation, please contact your distributor or the supplier of the interactive system.

HDMI/DVI Input Lets you connect a device, such as a digital cable box, with an HDMI or a DVI output.

- **HDMI/DVI INPUT** (High-Definition Multimedia Interface/Digital Visual Interface) Provides an uncompressed digital connection that carries both video and audio data by way of an integrated mini-plug cable. Since HDMI technology is based on Digital Visual Interface (DVI), the jack on the back of your TV is also compatible with DVI devices.
- **L AUDIO (used for DVI only)** Provides left audio connection when using the DVI jack. The left audio connector is usually white.
- **R AUDIO (used for DVI only)** Provides right audio connection when using the DVI jack. The right audio connector is usually red.

***Note:** Remember to connect the left and right audio cables because the DVI cable carries only the picture signal, not the sound.*

HOSPITAL PENDANT This specialized remote control is recognized for use in patient beds. It is used to connect to a pillow speaker, nurse-call system, or other device to supply speaker-level audio or accept remote control commands. The connector is a (3-wire) phono jack. Some are simple, having one-button operation of the TV; others have enhanced capability for greater control. Specific models and requirements depend on what other devices are in the hospital room, for example, nurse-call systems. See your distributor for more information.

MONITOR OUT Connect a VCR or DVD-recorder to record digital and analog programs from the Digital or Analog Input (excluding copy-protected programs and component video formats) while the TV is turned on. You must leave the TV on the same channel you are recording.

VGA Connect your computer, or other device with a VGA output, to this jack using a 15 pin D-sub cable.

VGA AUDIO (Stereo mini jack) Use to obtain sound when a PC is connected to the VGA jack. Use a 3.5 mm stereo mini pin cable (sometimes referred to as 1/8" stereo mini pin) to connect a PC to your TV.

Buttons and Other Jacks On Your TV

Front Panel Buttons

If you cannot locate your remote, you can use the front panel buttons of your TV to operate many of the TV's features.

MENU Brings up the TV Main menu.

VOL > Increases the volume. In the TV menu system, acts like the right arrow button on the remote control and adjusts menu controls.

VOL < Decreases the volume. In the TV menu system, acts like the left arrow button on the remote control and adjusts menu controls.

CH ^ Scans up through the channel list. In the TV menu system, acts like the up arrow button on the remote control and adjusts menu controls.

CH v Scans down through the channel list. In the TV menu system, acts like the down arrow button on the remote control and adjusts menu controls.

POWER Turns the TV on and off.

Right Side Input Jacks (when facing back of TV)

L/MONO and R AUDIO Receives audio from another device such as a camcorder, video game console, VCR, or DVD player. Use when connecting to the VIDEO or S-VIDEO Input.

VIDEO Input Receives video from another device such as a camcorder, video game console, VCR, or DVD player. To access a device connected to the VIDEO jacks press the INPUT button on your remote until *VID* appears at the bottom of the screen.

S-VIDEO Input Allows you to connect an S-Video cable from another device. Make sure you also connect audio cables from the device to the TV. To access a device connected to the VIDEO jacks press the INPUT button on your remote until *SVID* appears at the bottom of the screen.

Note: Do not connect an S-Video and a regular video cable to the side jacks at the same time.

Chapter 2: Using the Remote Control

Types of Remote Controls

All of the remote controls mentioned here, in addition to other remotes and accessories, are available from your RCA distributor. Descriptions of the remote buttons and how they work are on the next pages. Except as otherwise specified, the master remote is the remote described throughout the manual for operating the TV and setting up the TV's features.



Basic Remote R130K1

Master Remotes

The master remote control (R130K2) accesses all of the TV's menus. It is used to customize the TV's functionality for specific users or specific situations.

Basic Remotes

The basic remote control (R130K1) is used by the viewer for basic operating functions. It is designed so that the viewer cannot alter certain master remote-specified features. The Sleep, Closed Captioning, and Channel Guide features can be accessed directly with remote buttons.

ClonePRO™

The ClonePRO™ has main operating buttons that function the same as the master remote.

Additional Remote Buttons (R130K2)

MENU (MASTER) Brings up the master menu screen. This is different from the basic user menu screen.

RESET (MASTER) This button has no functionality with this product.

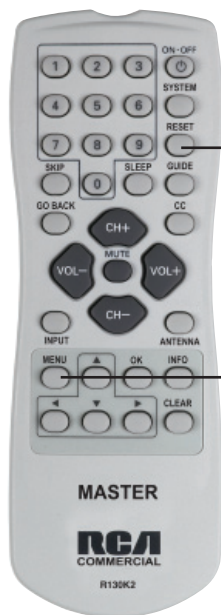

Master Remote R130K2

ClonePRO™ Remote Buttons

The ClonePRO™ can be used as a master remote. First, press ON to turn the remote on. Some of the buttons only apply when using the ClonePRO™ to download or upload information to or from a TV. Those buttons are described in Chapter 5.

Note: After 30 seconds of inactivity the remote will turn itself off.

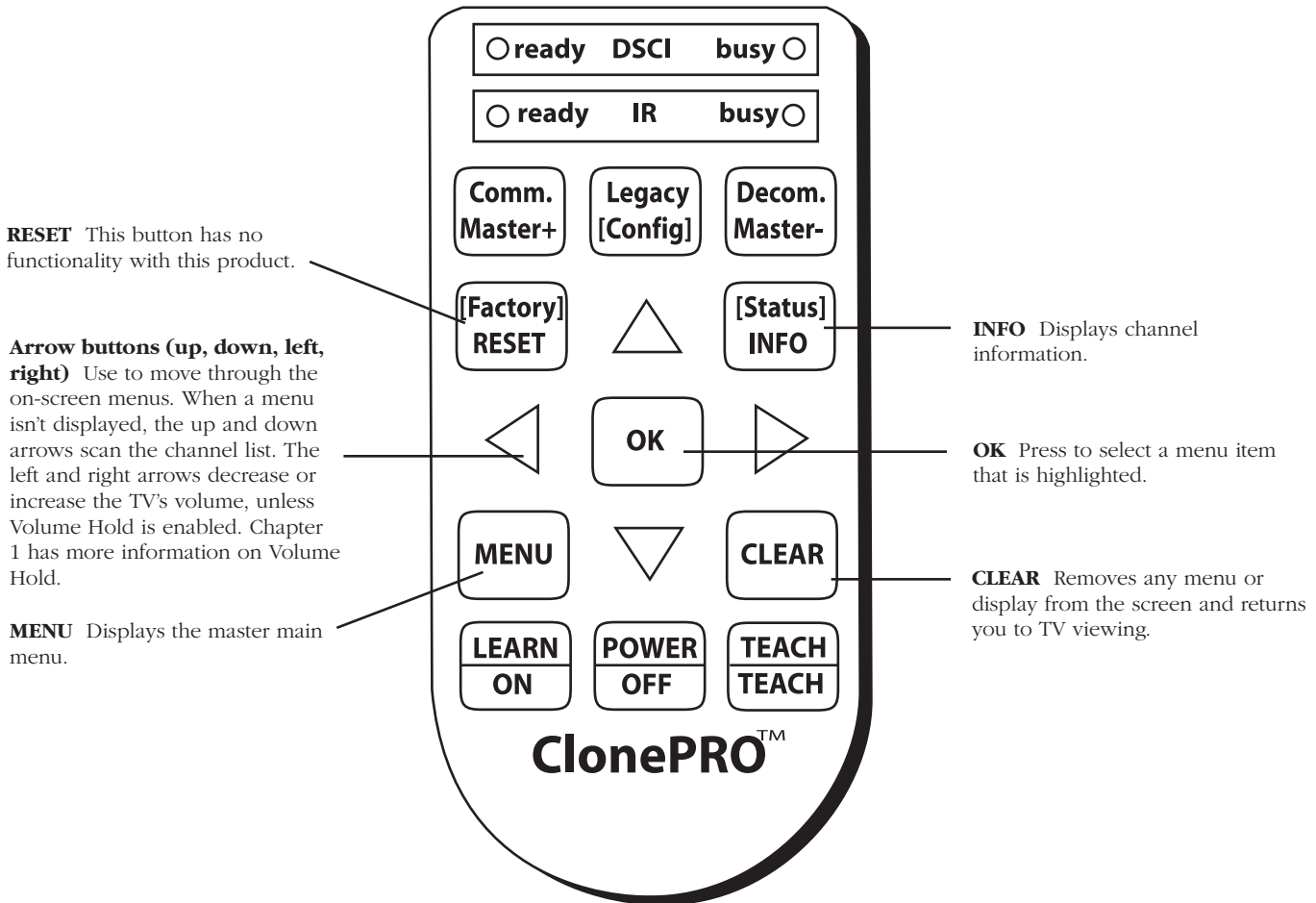

Chapter 3: Using the Menu System



The Basic Menu System

The basic menus are accessible through basic remote controls and the front panel. Which menu items are available will depend on the restrictions set by the master user and the active input. For instance, if *Basic Menu Access* has been set to *Disabled* in the *Access and Power Options* menu, the basic menus and many features will not be available. Also, except for some Parental Controls settings, many of the changes made in the basic menu will revert back to their master menu settings the next time the TV is turned on. Many of the basic menu items function exactly the same as their master menu counterparts. (See Chapter 1 for more details on the master menus.)

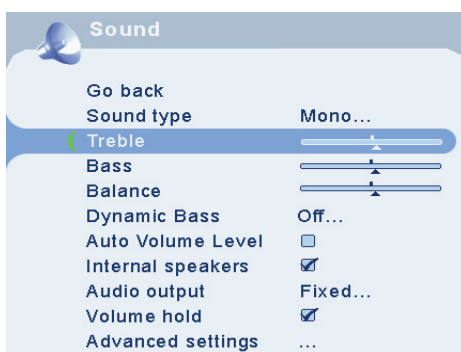

Sound Menu

Go Back Takes you to the previous menu.

Sound Type Plays the sound in Mono only. Mono is displayed in the Channel banner.

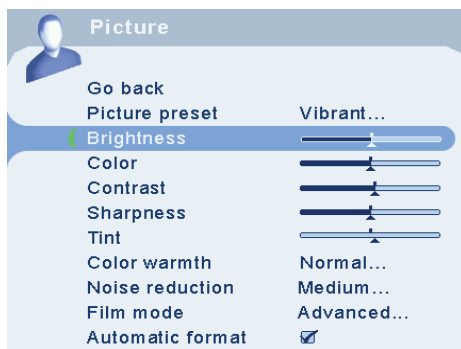

Picture Menu

The basic *Picture* menu items allow you to adjust the appearance of on-screen images.

Go Back Takes you to the previous menu.

Picture Preset Choose between *Soft*, *Natural*, *Bright* or *Personal*. The default setting is *Natural*.

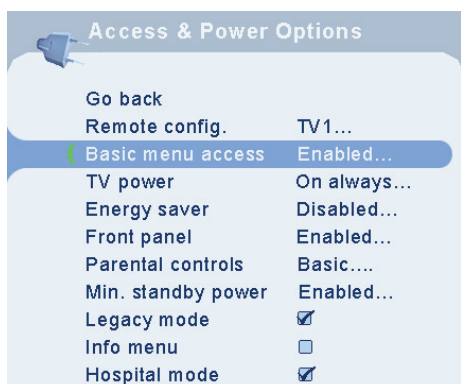

Access and Power Options Menu

The *Access & Power Options* menu allows the Master level user to set the remote configuration, the basic menu access, the front panel, the TV power setting, the energy saver setting and parental control access.

To prevent a complete lockout of system functions if the remote is disabled and the front panel controls are locked out; the **MENU** button on the Master remote will never be disabled.



Parental Control Menu

The basic *Parental Control* menu will depend on the options set by the master user. If the master user chooses *Allow Basic* on menu items, then all options are available. To set movie and TV ratings, content themes, etc., go to Chapter 4.

Go Back Takes you to the previous menu.

USA V-Chip Displays settings for the US version of V-Chip. If you live within the United States, choose this option.

Canada V-Chip Displays settings for the Canadian version of V-Chip. If you live in Canada, choose this option.

Unrated/Exempt Prg. (Program) This setting allows the master user to determine whether they will allow unrated/exempt programs to be shown. *Unlocked*- All unrated programs are shown. *Locked*- All unrated programs are not available. Page 24 has more information.

KidPass The KidPass feature allows parents to set a certain amount of time every day of the week that a child can watch TV.

Note: The time must be set for KidPass to function.

Lock Par. (Parental) Controls Puts into effect settings made in the Parental Control menu. A password is required.

Note: Parental Control Access is the master menu that controls which menus are available to the basic end user. Chapter 1 has more details.

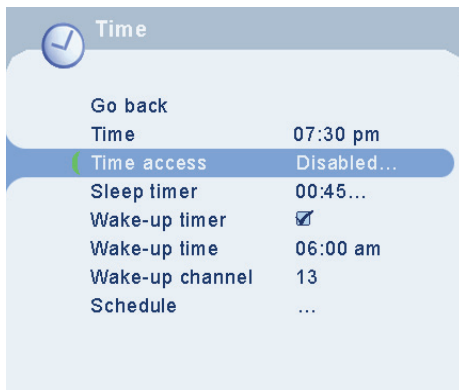

Time Menu

The functions of the basic *Time* menu will depend on the options set by the Master user.

Go Back Takes you to the previous menu.

Time Displays the current time if the master user has set the time.

Sleep Timer Lets you select the amount of time (in 15 minute increments) you want to give the TV before it shuts itself off (up to four hours). A message is displayed as a warning before the TV turns off. Select 00:00 to stop this function. This feature won't work if *TV Power* in the master menu is set to *On Always*. The default setting is 00:00.

Wake-Up Timer Displays a menu that lets you enter the time and channel you want your TV to turn to when it turns on.

Note: The Time Configuration menu allows the master user to make changes to the master menu regarding time. Chapter 1 has more details.

Using the Menu System

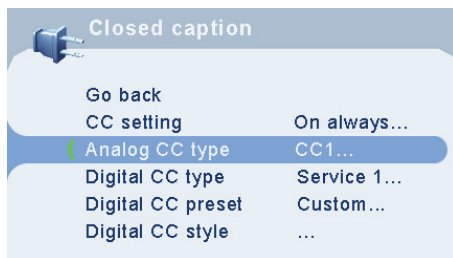

Language & CC Menu

Go Back Takes you to the previous menu.

Language Displays your preferred language for the menus. Select *English*, *Français* (French) or *Español* (Spanish).

CC Display Use the CC button on the remote to choose whether closed captioning information is shown on the screen.

CC Mode When CC Display is turned on, displays the CC mode: *CC1*, *CC2*, *CC3*, *CC4*, *T1*, *T2*, *T3* or *T4*.

Channel Banner

There are several indicators that might appear when you press the INFO button on the remote. This display is called the Channel Banner. The following list describes the items on the Channel Banner screen (left to right and top to bottom).

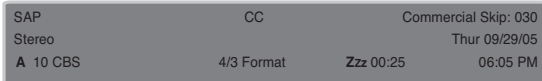

Analog Channel Banner

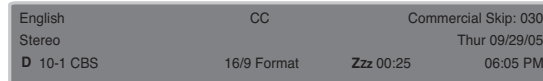

Digital Channel Banner

- SAP** The current channel is broadcasting SAP (Second Audio Program) information.
- CC** Closed Captioning is available on the current channel.
- Commercial skip 0:30** Shows the time remaining on the commercial skip (SKIP) timer.
- Stereo** *Stereo* appears when the current channel is broadcasting in stereo. *Mono* appears when the current channel is broadcasting in mono.
- Thur 09/29/05** Current date.
- A 10 CBS (analog)** The *A* means it's an analog channel. The channel and program you're currently viewing are displayed.
- D 10-1 CBS (digital)** The *D* means it's a digital channel. The channel, sub-channel (if available), and program you're currently viewing are displayed.
- 4/3 or 16/9 format** Current screen format. If there are black bars on-screen you might be able to get rid of them by pressing the LEFT/RIGHT ARROW buttons on the remote. Go to page 25 for more information on screen formats.
- Zzz 00:25** Current time left on sleep timer, if the sleep timer is set.
- 06:05 pm** Current time.

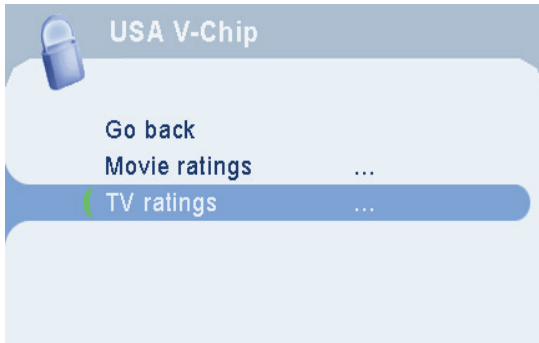

Parental Controls and V-Chip

The choices in the *US V-Chip* and *Canada V-Chip* menus involve software inside your TV (referred to as V-Chip) which allows you to lock TV programs and movies. TV programs can be locked by age-based ratings, such as TV-MA, which is explained on page 21. If available, TV programs can also be locked by content, such as adult language (L). This is explained on page 22. Movies can only be blocked by age-based ratings. This is explained on page 23.

Once you lock programs, you can unlock programs by entering a password.

By default, the software inside your TV is turned off or unlocked. For instructions to lock V-Chip, see below.

Note: Parental control settings are not available for HDMI or CMP1 or 2 inputs.

How V-Chip Works for USA and Canada

V-Chip reads the program's age-based rating (TV-MA, TV-14, etc.) and content themes [Violence (V), Adult Language (L), etc.]. If you have locked the rating and/or content themes that the program contains, you will receive the message *This channel is locked. Change channel or press OK to enter your password and temporarily deactivate the parental controls.*

Broadcasters are not required to provide content themes, so programs received with no content themes will only be blocked if you block their age-based rating. You can also block out programs that have been given an Exempt rating, and programs that are considered unrated. Go to page 38 for the US and Canada ratings explanations.



Lock/Unlock Parental Controls

Selecting this option lets you lock and unlock parental controls settings using a password.

If you do not lock parental controls, none of the settings for V-Chip, Channel Block, or Front Panel Lock will take effect.

If you forget your password, turn off the TV. Simultaneously press and hold VOL- on the front panel and CLEAR on the remote for 10 seconds. Next time you enter the *Parental control* menu enter a new password.

The V-Chip Rating Screen

The following is an example of where items are located within the Rating Limit screen.

Rating Status Field

Lets you select whether the status of the age-based rating limit to the left is View or Block.

Rating Field

Lets you select from a list of age-based ratings you can block or view.

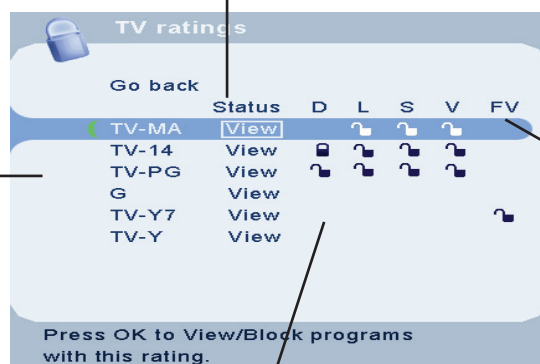

Content Themes

Lets the content themes you can block or view.

Content Status Fields

Lets you select which content themes to view for the selected rating, and whether the status of the content theme is currently unlocked (🔓) or locked (🔒).

Hierarchy of Age-Based Ratings	
TV-MA	Mature Audience Only
TV-14	Parents Strongly Cautioned
TV-PG	Parental Guidance Suggested
TV-G	General Audience
TV-Y7	Directed to Children 7 years and older
TV-Y	All Children

US V-Chip TV Ratings

Blocking Age-Based Ratings

You can automatically block all program ratings above a specified age-based rating level.

1. Choose *Parental control* from the Main Menu. If Parental controls have previously been locked, you must enter your password.
2. Highlight and select *US V-Chip*. Then select *TV ratings*.
3. Press the up or down arrow button to scroll to the rating corresponding with the lowest rating you do not want the child to watch.
4. Press the OK button to toggle between *View* and *Block*. The status for the rating and all higher ratings automatically changes to Block.
5. Use the up/down arrow buttons to highlight *Go back* and press OK.
6. Select *Lock Parental Controls* from the *Parental Control* menu for rating limits to take effect.

Note: If you forget your password, turn off the TV. Simultaneously press and hold VOL- on the front panel and CLEAR on the remote for 10 seconds. Next time you enter the Parental control menu enter a new password.

To view age-based ratings after you've locked them, follow the same steps as above to unlock.

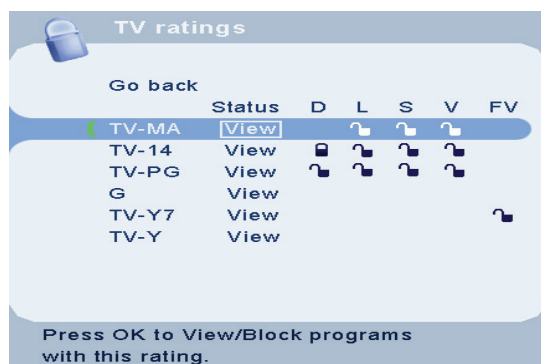

Using the TV's Features

Content Themes	
D	Sexually explicit dialogue
L	Adult language
S	Sexual situations
V	Violence
FV	Fantasy Violence

Blocking Specific Content Themes

You can block programs based on their content. (Content is represented by the *D*, *L*, *S*, *V* and *FV* on your screen.) When you block a content theme for a particular rating, you automatically block that content theme for higher rated programs as well.

To block program content:

1. Determine the content themes you want to block.
2. Press the down arrow button to scroll to the rating whose content theme you want to change.
3. Press the right arrow button to move the highlight to a particular content theme.
4. Press the OK button to change its status to lock. (In the example to the left, you block the language (L) corresponding with TV-14. The language for TV-MA is blocked as well.)

Notes: Broadcasters are not required to provide content themes or age-based ratings.

You must remember to lock Parental controls for rating limits to take effect.

To view content theme after you've locked them, follow the same steps as above to unlock. Note that if you unlock the language corresponding with TV-14, the language for TV-MA doesn't unlock. You have to unlock the content theme status for each rating separately.

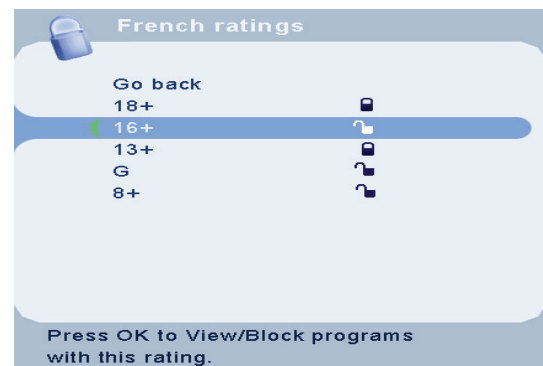
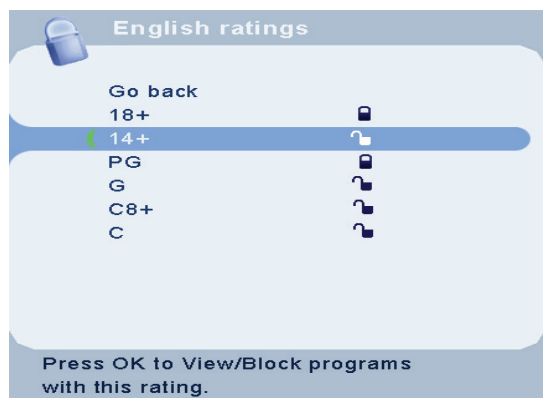
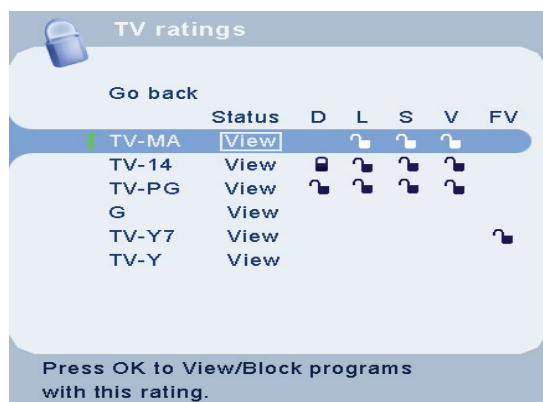

Blocking Canadian V-Chip Ratings

If you receive Canadian programs you can block Canadian English and French V-Chip by ratings only. When you block a particular rating, you automatically block the higher rated programs as well.

To block Canadian English and French program ratings:

1. Select *Canada V-Chip* from the *Parental control* menu.
2. Highlight *English ratings* or *French ratings* and press OK.
3. Determine the rating you want to block.
4. Press the down arrow button to scroll to the rating you want to change.
5. Press the OK button to change its status to block (all ratings above the one you selected change to block).

Use the number buttons to enter the channel you want to block, then press the down arrow button. Press OK to place a check mark in the *Lock channel* box to block the channel. When you tune to that channel you'll need to enter a password to view the channel if the TV is locked.

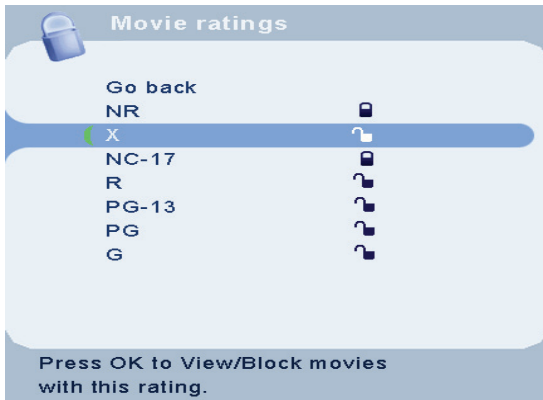

V-Chip Movie Rating Limit

Set movie rating limits by blocking movies rated above a specified level.

To access the Movie Rating Limit menu:

1. Press MENU on the remote control (the TV's *Main Menu* appears).
2. Select *Parental control*.
3. Select *US V-Chip*.
4. Select *Movie ratings*.

Blocking Movie Ratings

Once you are in the *Movie ratings* menu, follow the same steps described for blocking Canadian ratings.

Block Channels

Turn this option on to block the channel you choose in the *Select channel* option.

Use the number buttons to enter the channel you want to Block, then press the down arrow button. Press OK to place a check mark in the *Lock channel* box to block the channel. When you tune to that channel you'll need to enter a password to view the channel if the TV is locked.

Block Digital Channels

Turn this option on to block all digital channels. Press OK to place a check mark in the *Block all dig. channels* box to lock all channels. When you tune to a digital channel you'll need to enter a password to view the channel if the TV is locked.



Front Panel Lock

Select this option to lock (disable) or unlock (enable) the TV's front panel buttons so that they can't be used by someone, like a young child. The remote still tunes to any channel. If you're using this to keep children from changing channels, remove access to any remote that is capable of operating the television while you have the front panel blocked.

Don't forget to lock parental controls after you change the status. If you don't, the front panel block will not take effect.

Using the TV's Features

Lock Time Menu

Turn this option on to lock the *Time* menu so that the time settings can't be changed by someone, like a young child. Press OK to place a check mark in the box to lock the Time menu. When you access the *Time* menu you'll need to enter a password to view the channel.



Blocking Unrated/Exempt Programs

The *Unrated/Exempt* option lets you decide if programs that the V-Chip recognizes as unrated or exempt can be viewed. Unrated TV programs may include news, sports, political, religious, local and weather programs, emergency bulletins, public announcements, and programs without ratings. The Exempt option applies to both USA and Canadian unrated programs and Canadian programs rated *E*.

View All unrated programs are available.

Lock All unrated programs are not available.

Note: You must remember to lock Parental controls for rating limits to take effect.

Press the down arrow button to highlight *Unrated/Exempt*. Then press the right arrow button to toggle between *View* and *Lock*.

Future Rating Region

You might notice an option in your Parental control menu that wasn't there before. This is because broadcasters have the capability to add a new rating system for TV programs. These ratings let you define additional parameters for parental controls. This option and its name are dependent on the content acquired from the broadcaster.

Note: These ratings are available only if the broadcaster is sending them.

Additional Features

There are additional features available unrelated to Parental Controls. These features can be found in other menus.

Calendar

Use the calendar feature to display the current month and year, just like a calendar. The current month and year is displayed if you've set it correctly in the *Date* option in the *Time* menu.

1. Press the MENU button on the remote. Highlight *Time* and press OK.
2. Highlight *Calendar* and press OK.
3. To display a different month and year, highlight the selection and press the left or right arrow button to make a change.

Screen Formats

Screen format is the way the picture is displayed on your TV. Press the LEFT/RIGHT ARROW button on your remote to see if a different format is available for the video you are viewing. The format changes as you press the LEFT/RIGHT ARROW buttons and the format type is displayed at the bottom of the screen.

Analog video is sent in a 4/3 format, which your TV displays in a 16/9 format. Most digital video is sent in a 16/9 format which does fill your screen, but sometimes is sent in 4/3 which does not fill your screen. It depends on how the station or device connected to your TV is formatting the video. If there are bars on-screen, press the LEFT/RIGHT ARROW button to try a different format that may eliminate the bars. If the analog format type is zoom or panning, use the up or down arrow button to make adjustments to the picture and/or eliminate the bars.

Listed below are the different formats available and what they look like.

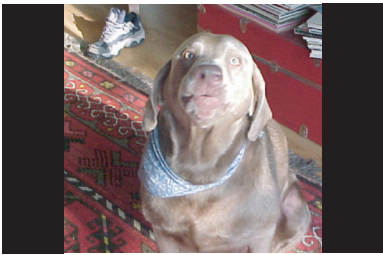

4/3 (available for analog video; may be available for digital video)

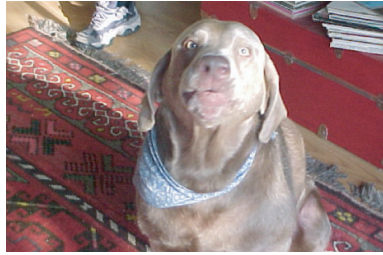

16/9 zoom (available for analog video; may be available for digital video)

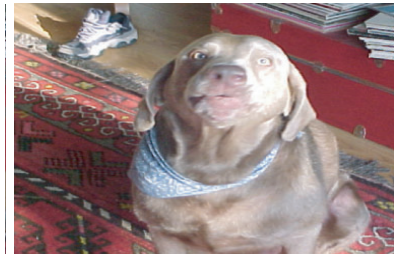

Horizontal stretch (may be available only for digital video)

The following formats are only available for analog video:

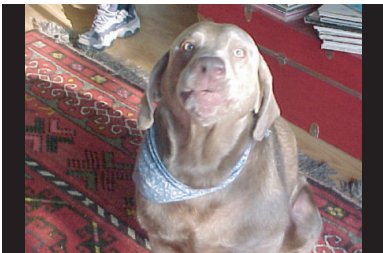

14/9 zoom

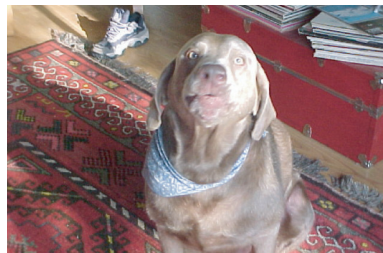

16/9

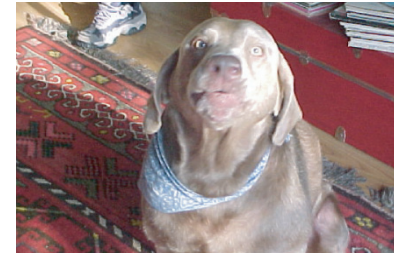

Cinerama

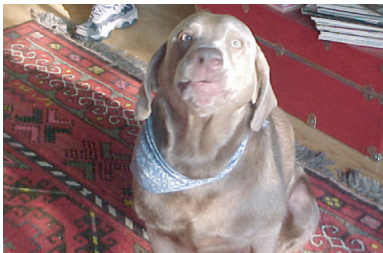

16/9 panning

Chapter 5: Other Information

Frequently Asked Questions (FAQs)

What's the quickest way to view High Definition (HD) video?

Connect an off-air antenna to the ANTENNA CABLE/DIGITAL INPUT to view free local digital channels. You might need to purchase an antenna. Go to page 6 for more information.

Visit www.antennaweb.org to get help deciding what type of antenna to use to receive the local digital channels available to you. By entering where you live, this mapping program tells you what local analog and digital stations are available using a certain antenna.

Are there other ways to view High Definition (HD) video?

Besides using an off-air antenna as mentioned above, you can also use a set-top box to receive digital video. Contact your cable company to purchase digital cable and have them connect the box for you to ensure you're viewing channels the best way.

How do I tell an analog channel from a digital channel?

Press the INFO button to display the channel banner. Look at the bottom left corner of the screen. An *A* is displayed for an analog channel. A *D* is displayed for a digital channel.

Why are there bars on my screen and can I get rid of them?

Most digital video is sent in a 16/9 format which does fill your screen, but sometimes is sent in 4/3 which does not fill your screen. It depends on how the station or device connected to your TV is formatting the video. If there are bars on-screen, press the LEFT/RIGHT ARROW button to try a different format that may eliminate the bars. The format changes as you press the LEFT/RIGHT ARROW buttons and the format type is displayed at the bottom of the screen. For more information on screen formats, go to page 24.

Why does channel search find a lot of channels, but when I try to tune to them there's nothing there?

Some channels are enabled by the cable company that don't carry programming, such as video-on-demand. When channels are unavailable, your TV's screen is blank or appears like snow. You probably want to get rid of these so they no longer appear in your channel list. Remove these in the *Channel List* menu. Go to page 30 for more information.

Why does the first channel search take a long time?

If you've connected a signal to both ANALOG and DIGITAL INPUTS, the TV is looking for all available channels in the channel list. If you do have digital channels, the TV is also searching for each sub-channel of that digital channel.

Using the ClonePRO™

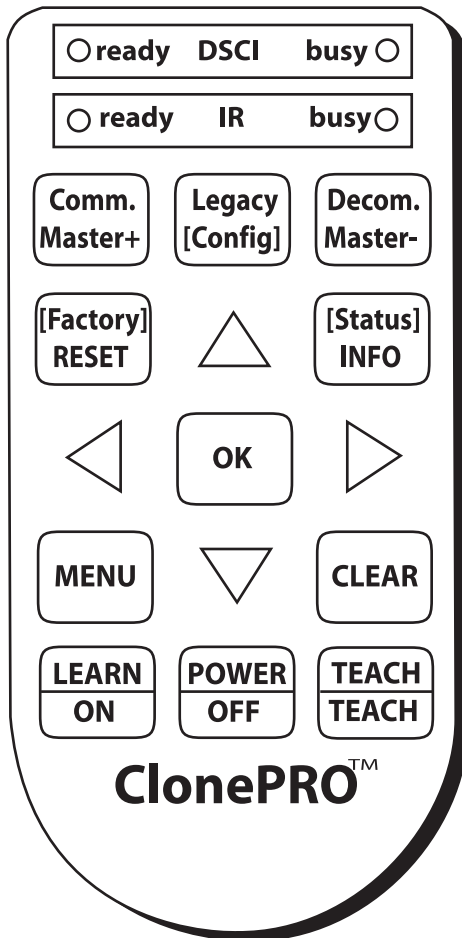

Modes of operation

The ClonePRO™ operates from one of two modes:

DSCI Connect a DSCI cable to the ClonePRO and to the TV's DSCI port on the back panel.

IR (Infrared) This operation is wireless. Press ON to begin using the remote in IR mode.

The corresponding “ready” light indicates the mode of operation, and the corresponding “busy” light indicates activity in this mode.

Buttons with black labels function similarly in both modes, while green labels operate DSCI mode and red labels operate IR mode.

DSCI mode

The ClonePRO™ enters this mode when it is connected to the TV's Digital Serial Communications Interface port via a cable (included).

- Any standard (no-flip, 1-to-1) 8-conductor computer-networking cable may be used.
- No battery is required in this mode.
- If the unit is already in IR mode, press OFF to speed the transition to DSCI mode.

DSCI (green) Buttons

Comm. This button has no functionality with this product.

Decom. This button has no functionality with this product.

Factory This button has no functionality with this product.

LEARN Begins the process of learning the settings from a TV that has been setup as desired.

Note: Pressing LEARN overwrites any settings already in the ClonePRO™.

Legacy Places the TV in a mode in which it emulates the behavior of older models. This is a required part of the configuration for some applications.

POWER Turns on the TV. It is recommended, though not required, when in DSCI mode to view on-screen displays.

Continues on next page...

Other Information

Status Press and hold the INFO button for several seconds to display settings stored in the ClonePRO™ and the TV. For example, *Mem: CB:36 TV:36*. This tells you the ClonePRO and the TV have 36 pages of information stored in memory.

Across the screen are red dashes. Press any button on the remote control you are using. Red pulses should appear, telling you the TV is recognizing the remote and is able to send out that information. If red pulses don't appear, contact your RCA distributor.

TEACH This begins the process of teaching the settings stored in the ClonePRO™ to the TV to which it is connected.

Note: Pressing TEACH overwrites any settings already in the TV.

After successful teaching, the TV will turn off and reboot.

If the memory-image stored in the clone-box is not valid for the TV, an on-screen message will advise of the conflicting memory-sizes.

IR Mode

The ClonePRO enters the IR mode when any button on the bottom row of the keypad is pressed (without connection to a TV DSCI port). A standard 9V battery (accessed via a small rear panel) is required to enable this mode.

Notes: Like any IR (infrared) remote control, the ClonePRO™ requires a reasonable line of sight between it and the TV for proper signaling. Obstructions, long distances, sharp angles and certain specialty lighting can reduce the effective range.

If the "IR ready" light stays on longer than 1 minute by itself, temporarily remove the battery to reset it.

Remove the battery prior to long-term storage.

IR (red) Buttons

Note: You must press the ON button for the IR buttons to operate.

Master+ & Master- The Master- button disables access to the TV's master menus via the master remote. (Some third-party devices, attached to the TV's DSCI port as part of a larger system, may disable access to master menus even after they are disconnected.) To enable the master menus, press Master+.

OFF Turns the TV off, and turns the ClonePRO™ off.

ON Turns the TV on, and turns on the ClonePRO™ IR mode, ready for subsequent buttons. Note that the unit will automatically turn itself off 30 seconds after the last button has been pressed to extend battery-life.

TEACH Begins teaching the settings stored in the ClonePRO™ to the TV, effectively "Cloning" the initially configured TV. May be made more reliable for older models by first filling the memory of the example TV with channel-labels on unused channels.

After an IR TEACH, older-model TVs do not need to reboot.

Note: Pressing TEACH overwrites any settings already in the TV.

- A TV must be turned on before being taught in IR mode.
- After successful teaching, the TV turns off and turns on with the new settings.
- If the TV displays the message *Cloning Timeout* or *Cloning Aborted*, press TEACH again to retry, experimenting with the ClonePRO™ at different distances and angles from the TV.
- If no valid settings have been stored via a DSCI LEARN, the IR ready light will come on but nothing will appear on the TV screen.

Note: *The ClonePRO™ cannot be used to cross clone (to copy the memory of older models into newer models, or vice versa), because the two have completely different memory-maps,*

Cloning a TV

Use the ClonePRO™ or a master remote to complete any necessary setup steps to the TV, such as Auto Channel Search, changing Access & Power options, etc. Go to Chapter 1 for more information on setting up the TV. When you have finished setting up the TV, you can use it as your example TV.

1. Connect the ClonePRO™ to the example TV's DSCI port.
2. It is recommended, though not required, to turn on the TV. Press the POWER button.
3. Press the LEARN button to begin the cloning process. When it is complete, *Cloning Complete* is displayed on-screen.
4. Take the ClonePRO to each subsequent TV and then (in either DSCI or IR mode) TEACH each TV, monitoring the process on-screen.

The settings learned by the ClonePRO™ remain indefinitely, ready to TEACH the next TV until overwritten by a new LEARN operation.

ClonePRO™ Troubleshooting

Problems with the DSCI mode

- Make sure the TV is plugged into a live electrical outlet.
- Make sure the ClonePRO™ is plugged into the TV's DSCI port.
- The connecting cable should have at least 6 wires, mapping 1-to-1 (not flipped).

ClonePRO™ remote isn't working

- Check the battery. Place a new 9V battery in the unit if the battery is old.
- Make sure the ClonePRO™ is pointed at the TV with a clear line of sight.
- If you are trying to TEACH, make sure there is a valid memory stored in the ClonePRO™ (Check by going into DSCI-mode [Status].)

Troubleshooting

Most problems you encounter with your TV can be corrected by consulting the following troubleshooting list.

TV Problems

TV won't turn on

- Make sure the TV is plugged in.
- Check the wall receptacle (or extension cord) to make sure it is “live” by plugging in something else.
- The front panel controls may be locked (disabled). Use the remote control to unlock the front panel controls by selecting the *Front Panel Block* in the *Parental control* menu and press OK to uncheck the box.

No picture, no sound but TV is on

- You might be tuned to an input with no device connected to it to view. If you're trying to view a connected device, press INPUT until the picture from that device appears or press ANTENNA to watch TV.
- Maybe the *Signal source* option is set incorrectly.
- The channel might be blank — change channels.
- If you're watching your VCR and it's connected with coaxial cable to the ANALOG or DIGITAL INPUT jack, tune the TV to channel 3 or 4 (whichever channel is selected on the 3/4 switch on the back of your VCR). Also check to make sure the TV/VCR button on the VCR is in the correct mode (press the TV/VCR button on your VCR).

Sound okay, picture poor

- If you're getting a black and white picture from a device you've connected to your TV, you might have your video cables connected to the wrong jacks. A yellow Video cable connects to the yellow VIDEO input jack on the side of your TV; three yellow video cables or bundled component video cables (red, blue, and green) connect to the COMPONENT INPUT jacks on the back of your TV.
- If you're getting no picture from a device you've connected to your TV, you might have your video cable connected to the MONITOR OUT jacks on the back of your TV. These jacks are used to connect recording devices. A yellow Video cable connects to the yellow VIDEO input jack on the side of your TV.
- Check antenna connections. Make sure all of the cables are firmly connected to the jacks.
- Try adjusting sharpness function to improve weak signals.

No sound, picture okay

- Maybe the sound is muted. Try pressing the volume up button to restore sound.
- If using S-Video or Y, PB, PR, remember to also connect the device's left and right audio output jacks to the TV's L and R Audio Input jacks.
- The sound settings may not be set correctly.
- The internal speakers might be turned off.

Blank screen

- Check your connections. If you used yellow, red, and white cables to connect, make sure they're connected to the yellow, red, and white jacks on the side of the TV, not to the MONITOR OUT jacks on the back of the TV.
- If you're trying to watch something that's playing on a device connected to the TV (like a DVD), press INPUT until you get to the correct video input channel.
- Press the ANTENNA button.
- Make sure the device connected to the TV is turned on.
- Try another channel.

Buttons don't work

- The front panel controls may be locked (disabled). Use the remote control to unlock the front panel controls by selecting the *Front Panel Block* in the *Parental control* menu and press OK to uncheck the box.
- Unplug the TV for ten minutes and then plug it back in. Turn the TV on and try again.

TV turns off unexpectedly

- Sleep timer may have been activated.
- Electronic protection circuit may have been activated because of a power surge. Wait 30 seconds and then turn on again. If this happens frequently, the voltage in your house may be abnormally high or low.
- Unplug. Wait ten minutes. Plug in again.

TV turns on unexpectedly

- Wake up timer might have been activated.

Can't select certain channel

- Channel may be blocked or not approved in the *Parental Controls* menu.
- If using a VCR, check to make sure the TV/VCR button on the VCR is in the correct mode (press the TV/VCR button on your VCR).
- Press the ANTENNA button and then try to change channels.

Noisy stereo reception

- May be a weak station. Use *Sound* menu to choose mono sound.

Volume buttons not adjusting volume louder

- Check to make sure volume isn't limited by the maximum volume feature.

Black box appears on the screen

- Closed-captioning might be on. Check *Closed Caption* in the *Setup* menu.

TV picture keeps switching between screen formats abruptly

- Switch the *Automatic format* feature off.

Problems with HDMI/DVI Connection

- Make sure the HDMI or DVI device is turned on and the cables are firmly connected. If problems still occur, turn off your device. Re-connect your device. Reset the power by unplugging the power cord and plugging it back in.
- If you are tuned to the HDMI/DVI input and you're receiving *Unusable Signal* message on-screen, press the INFO button on the remote. If *Acquiring Channel* appears in the channel banner, the HDMI or DVI device isn't responding. Contact the manufacturer of the HDMI or DVI device for further assistance.
- If you tune to the HDMI/DVI input and you see snow, the video goes in and out, or the video takes a long time to appear, your HDMI or DVI device is having trouble sending video information to the TV. Re-connect your device. Reset the power by unplugging the power cord and plugging it back in. If problems persist, try connecting the Y Pb Pr jacks instead if they are available or contact the manufacturer of the HDMI or DVI device for further assistance.
- If you have black bars on each side of your picture, the device you connected might have a switch or a menu option allowing you to change the picture quality output that will fix this. Choose either 720p or 1080i.
- 480i signals aren't supported by the HDMI/DVI input.

Other Information

The Remote Control Doesn't Work

- Something might be between the remote and the remote light sensor on the front of the TV. Make sure there is a clear path.
- Maybe the remote isn't aimed directly at the TV.
- Maybe batteries in remote are weak, dead, or installed incorrectly. Put new batteries in the remote. (Note, if you remove the batteries, you may have to reprogram the remote to operate other devices.)

Problems with V-Chip/Parental Controls

The rating limits don't work

- You must lock the settings. Go to the *Main Menu* (press MENU on your remote), select *Parental control*, select *Lock Parental Controls*.

I don't remember my password and I want to unlock the TV

- If you forget your password, turn the TV off. Simultaneously press and hold VOL- on the front panel and CLEAR on the remote for 10 seconds. Next time you enter the *Parental control* menu enter a new password

The V-Chip won't let me watch a program even though it's not rated as violent.

- Maybe the movie was given an NR (Not Rated) status. After you block movie ratings, you must set *NR* to *View* separately in order to view movies with an NR rating.

What Else Can I Do?

If you've been through the Troubleshooting section and nothing has fixed your problem, try rebooting your TV. Note that after a reboot you may need to run your TV through the setup process again. To do a reboot, unplug the power cord from the wall outlet, power strip, etc. Keep your TV unplugged for about 5 minutes. Then plug the TV back in, turn on the TV, and see if the problem is fixed. If the problem remains, then please visit www.rca.com/television for updated FAQs or contact RCA Customer Support at the support number provided in your Warranty under *How To Get Service*.

Mounting Your TV to the Wall

Caution: The wall mount must bear a minimum of five times the TV's net weight without causing damage.

To mount your TV to the wall you need to purchase a VESA wall mount. For model J26L637, purchase a VESA MIS-F, 400, 200, 4 (400, 200 means the mounting measurements are 400mm horizontally and 200mm vertically; 4 means M4 type screws need to be used). For models J32L637, purchase a VESA MIS-F, 400, 200, 6 (400, 200 means the mounting measurements are 400mm horizontally and 200mm vertically; 6 means M6 type screws need to be used).

1. You need to remove the base first before attaching the wall mount.
 - A. Place the TV facedown on a surface that is soft, yet strong enough to hold the TV.
 - B. Use a screwdriver to remove the screws from the four holes on each side of the TV's base as the arrows indicate on the base.
2. Make sure all cables are already connected to the TV.
3. Follow the directions included with the wall mount to mount the TV to the wall.

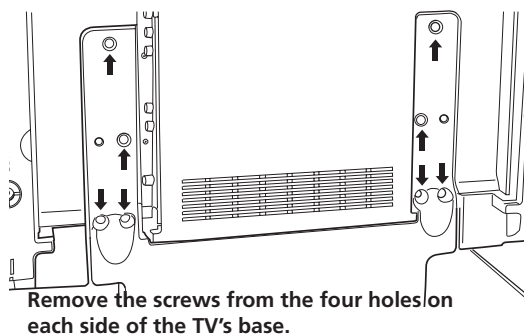

V-Chip Rating Explanations

US V-Chip Rating System

TV-MA (Mature Audience Only) Specifically designed to be viewed by adults and may be unsuitable for children under 17. It contains one or more of the following content themes: crude indecent language (L), explicit sexual activity (S), or graphic violence (V).

TV-14 (Parents Strongly Cautioned) Contains some material that many parents would find unsuitable for children under 14. Parents are strongly urged to exercise greater care in monitoring this program and are cautioned against letting children under the age of 14 watch unattended. This program contains one or more of the following content themes: intensely suggestive dialogue (D), strong coarse language (L), intense sexual situations (S), or intense violence (V).

TV-PG (Parental Guidance Suggested) Contains material that parents may find unsuitable for younger children. Many parents may want to watch it with their younger children. The program contains one or more of the following content themes: some suggestive dialogue (D), infrequent coarse language (L), some sexual situations (S), or moderate violence (V).

TV-G (General Audience) Most parents would find this program suitable for all ages. It contains little or no sexual dialogue (D) or situations (S), no strong language (L), and little or no violence (V).

TV-Y7 (Directed to Children 7 years and older) Designed for children ages 7 and above. It may be more appropriate for children who have acquired the developmental skills needed to distinguish between make-believe and reality. Themes and elements in this program may include mild fantasy violence (FV) or comedic violence, or may frighten children under the age of 7.

TV-Y (All Children) Themes and elements in this program are designed for a young audience, including children from ages 2-6. It is not expected to frighten younger children.

Canadian English V-Chip Rating System

18+ (Adults) Programming intended for adults 18 and older. It may contain elements of violence, language, and sexual content which could make it unsuitable for viewers under 18. Violence Guidelines: May contain violence integral to the development of the plot, character or theme, intended for adult audiences. Other Content Guidelines: May contain graphic language and explicit portrayals of nudity and/or sex.

14+ (Viewers 14 and over) Programming contains themes or content which may not be suitable for viewers under the age of 14. Parents are strongly cautioned to exercise discretion in permitting viewing by pre-teens and early teens. Violence Guidelines: May contain intense scenes of violence. Could deal with mature themes and societal issues in a realistic fashion. Other Content Guidelines: May contain scenes of nudity and/or sexual activity. There could be frequent use of profanity.

PG (Parental Guidance) Programming intended for a general audience but which may not be suitable for younger children (under the age of 8). Parents may consider some content inappropriate for unsupervised viewing by children aged 8-13. Violence Guidelines: Depictions of conflict and/or aggression will be limited and moderate; may include physical, fantasy, or supernatural violence. Other Content Guidelines: May contain infrequent mild profanity, or mildly suggestive language. Could also contain brief scenes of nudity.

Continues on next page...

Other Information

G (General Audience) Programming considered acceptable for all ages groups. While not designed specifically for children, it is understood younger viewers may be part of the audience. Violence Guidelines: Will contain very little violence, either physical or verbal or emotional. Will be sensitive to themes which could frighten a younger child, will not depict realistic scenes of violence which minimize or gloss over the effects of violent acts. Other Content Guidelines: There may be some inoffensive slang, no profanity and no nudity.

C8+ (Children 8 and Older) Programming generally considered acceptable for children 8 years and over to watch on their own. Violence Guidelines: Violence will not be portrayed as the preferred, acceptable, or only way to resolve conflict or encourage children to imitate dangerous acts which they may see on television. Any realistic depictions of violence will be infrequent, discreet, of low intensity and will show the consequences of the acts. Other Content Guidelines: There will be no profanity, nudity or sexual content.

C (Children) Programming intended for children under age 8. Violence Guidelines: Careful attention is paid to themes which could threaten children's sense of security and well being. There will be no realistic scenes of violence. Depictions of aggressive behaviour will be infrequent and limited to portrayals that are clearly imaginary, comedic or unrealistic in nature. Other Content Guidelines: There will be no offensive language, nudity or sexual content.

Canadian French V-Chip Rating System

18+ (Adults) Programming is for adults only. This program contains sustained violence or extremely violent scenes.

16+ (Viewers 16 and over) Programming is not suitable for those under age 16. This program contains frequent scenes of violence or intensely violent scenes.

13+ (Viewers 13 and over) Programming may not be suitable for children under the age of 13. This program either contains several violent scenes or one or more scenes that are violent enough to affect them. Viewing in the company of an adult is therefore strongly recommended for children under the age of 13.

8+ (Viewers 8 and over) Not recommended for young children. This program is suitable for most audiences, but it contains mild or occasional violence that could upset young children. Viewing in the company of an adult is therefore recommended for young children (under the age of 8) who do not distinguish between reality and imagination.

G (General Audience) This program is suitable for audiences of all ages. It contains no violence, or any violence that it does contain is either minimal or is presented in a humorous manner, as a caricature, or in an unrealistic way.



Autotuning

Note: Autotuning is not available with your remote. You must purchase a compatible RCA universal remote to use the autotuning feature.

The autotuning feature automatically tunes the TV to the correct video input channel for different devices you have connected to your TV. When you set up autotuning in the menu system you don't have to remember to change your TV to the VID input, for example, when you want to watch a tape on the VCR.

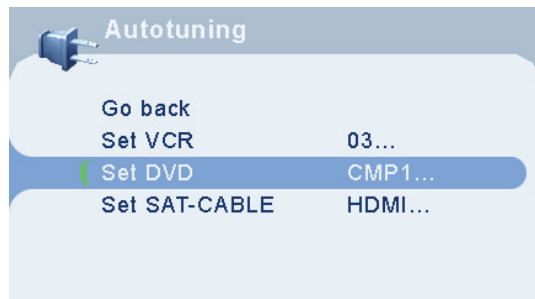

How to Set Up the Autotuning Feature

The way you set up the autotuning feature in the TV's menu corresponds to the device buttons on the remote and the way you have each device connected to your TV. When you set up autotuning, you're telling the TV what channel/input to tune to when you press the corresponding button on the remote control.

1. Press MENU (the MAIN MENU appears).
2. Highlight *Channel setup* and press OK on your remote control.
3. Highlight *Autotuning* and press OK.
4. Choose which device button you would like to set:

Set VCR Channel Lets you set up the channel the TV tunes to when you press the VCR button.

Set DVD Channel Lets you set up the channel the TV tunes to when you press the DVD button.

5. Press the right arrow button to select the choice that matches the way you have the device connected to this TV, and press OK.

You can select from the following inputs or channels:

N/A Choose this if you don't have this particular device connected to the TV, or if you don't want the TV to automatically tune to the correct channel/input when you're using this device.

Channel 3 or 4 Device is connected to the ANTENNA/CABLE ANALOG or DIGITAL INPUT jack on the back of the TV, and you want the TV to tune to channel 3 when you press the corresponding button on the remote. Reminder: make sure the device's Channel 3/4 switch is set to Channel 3.

VID or SVID (Video or S-Video Input) Device is connected to a VIDEO or S-Video jack on the side of the TV and you want the TV to tune to the front VIDEO or S-VIDEO input channel when you press the corresponding device button.

CMP1 or CMP2 (Component Video Input) Compatible component video source, such as an HDTV tuner or satellite receiver, is connected to the three COMPONENT VIDEO INPUT jacks (Y Pb Pr) on the back of the TV and you want the TV to tune to the component video input channel (CMP1 or CMP2) when you press the corresponding device button.

HDMI Device is connected to the HDMI/DVI jack on the back of the TV and you want the TV to tune to the HDMI input channel when you press the corresponding device button.

Other Information

Limited Warranty

What your warranty covers:

- Defects in materials or workmanship.

For how long after your purchase:

- 1 year from date of purchase for parts and labor.

What we will do within one year:

- At our option, either (a) pay any Authorized RCA Television Service Center the labor charges, plus replacements parts, to repair your television, or (b) replace your television.
- At our option, the replacement parts or replacement television provided under the warranty may be new or refurbished.

What your warranty *does not* cover:

- Acts of nature, such as but not limited to lightning damage.
- Adjustment of customer controls.
- Damage from misuse or neglect.
- A unit that has been modified or incorporated into other products or is used for institutional or other commercial purposes.
- Batteries.
- Units purchased or serviced outside the U.S.A.
- Shipping damage if the unit was not packed and shipped in the manner prescribed by TTE Technology, Inc..
- Customer Instruction. (Your Owner's Manual describes how to install, adjust, and operate your unit. Any additional information should be obtained from your dealer.)

How you get service:

- Take your RCA television to any Authorized RCA Television Service Center and pick up when repairs are complete.
- To identify your nearest Authorized RCA Television Service Center, ask your dealer, visit www.rca.com/television, look in the Yellow Pages, or call 1-800-951-9582.
- Proof of purchase in the form of a bill of sale or receipted invoice which is evidence that the product is within the warranty period must be presented to obtain warranty service. For rental firms, proof of first rental is also required.

Product Registration:

- Please complete and mail the Product Registration Card packed with your TV or register on-line at www.rca.com/television. It will make it easier to contact you should it ever be necessary. The return of the card is not required for warranty coverage.

Limitation of Warranty:

- **THE WARRANTY STATED ABOVE IS THE ONLY WARRANTY APPLICABLE TO THIS PRODUCT. ALL OTHER WARRANTIES, EXPRESS OR IMPLIED (INCLUDING ALL IMPLIED WARRANTIES OF MERCHANTABILITY OR FITNESS FOR A PARTICULAR PURPOSE) ARE HEREBY DISCLAIMED. NO VERBAL OR WRITTEN INFORMATION GIVEN BY TTE TECHNOLOGY, INC., ITS AGENTS OR EMPLOYEES SHALL CREATE A WARRANTY OR IN ANY WAY INCREASE THE SCOPE OF THIS WARRANTY.**

- **REPAIR OR REPLACEMENT AS PROVIDED UNDER THIS WARRANTY IS THE EXCLUSIVE REMEDY OF THE CONSUMER. TTE TECHNOLOGY, INC. SHALL NOT BE LIABLE FOR INCIDENTAL OR CONSEQUENTIAL DAMAGES RESULTING FROM THE USE OF THIS PRODUCT OR ARISING OUT OF ANY BREACH OF ANY EXPRESS OR IMPLIED WARRANTY ON THIS PRODUCT. THIS DISCLAIMER OF WARRANTIES AND LIMITED WARRANTY ARE GOVERNED BY THE LAWS OF THE STATE OF INDIANA. EXCEPT TO THE EXTENT PROHIBITED BY APPLICABLE LAW, ANY IMPLIED WARRANTY OF MERCHANTABILITY OR FITNESS FOR A PARTICULAR PURPOSE ON THIS PRODUCT IS LIMITED TO THE APPLICABLE WARRANTY PERIOD SET FORTH ABOVE.**

How state law relates to warranty:

- Some states do not allow the exclusion nor limitation of incidental or consequential damages, or limitations on how long an implied warranty lasts, so the above limitations or exclusions may not apply to you.
- This warranty gives you specific legal rights, and you also may have other rights that vary from state to state.

If you purchased your product outside the United States:

- This warranty does not apply. See your dealer for warranty information.

Service calls which do not involve defective materials or workmanship are not covered by this warranty. Costs of such service calls are the sole responsibility of the purchaser.

Care and Cleaning

CAUTION: Turn OFF your TV before cleaning.

You can clean the TV as required, using a dry cloth. Be sure to occasionally dust the ventilation slots in the cabinet to help assure adequate ventilation.

IMPORTANT: Do not allow liquid to come in contact with the TV, or allow liquid to run down the screen and inside the TV. Also, never place drinks or vases with water on top of the TV. This could increase the risk of fire or shock hazard or damage to the TV. Never use cleaning agents, they will damage the TV.



As an ENERGY STAR® Partner, TTE Technology, Inc. has determined that this product meets the ENERGY STAR guidelines for energy efficiency.

ENERGY STAR and The ENERGY STAR mark are registered U.S. marks.

FCC Information

This equipment has been tested and found to comply with the limits for a Class B digital device, pursuant to Part 15 of the FCC Rules. These limits are designed to provide reasonable protection against harmful interference in a residential installation. This equipment generates, uses, and can radiate radio frequency energy and, if not installed and used in accordance with the instructions, may cause harmful interference to radio communications. However, there is no guarantee that interference will not occur in a particular installation. If this equipment does cause harmful interference to radio or television reception, which can be determined by turning the equipment off and on, the user is encouraged to try to correct the interference by one or more of the following measures:

1. Reorient or relocate the receiving antenna.
2. Increase the separation between the equipment and receiver.
3. Connect the equipment into an outlet on a circuit different from that to which the receiver is connected.
4. Consult the dealer or an experienced radio/TV technician for help.

Visit the RCA website at www.rca.com/television

Please do not send any products to the Indianapolis address listed in this manual or on the carton. This will only add delays in service for your product.

TTE

TTE Technology, Inc.

101 West 103rd Street

Indianapolis, IN 46290

©2006 TTE Technology, Inc.

RCA and associated marks are trademarks of THOMSON S.A. used under license to TTE Corporation.

TOCOM 1669917A

Free Manuals Download Website

<http://myh66.com>

<http://usermanuals.us>

<http://www.somanuals.com>

<http://www.4manuals.cc>

<http://www.manual-lib.com>

<http://www.404manual.com>

<http://www.luxmanual.com>

<http://aubethermostatmanual.com>

Golf course search by state

<http://golfingnear.com>

Email search by domain

<http://emailbydomain.com>

Auto manuals search

<http://auto.somanuals.com>

TV manuals search

<http://tv.somanuals.com>