



User's Guide

For Systems: HT35713BD,
HT60903BD, 253 Series,
802 Series & 852 Series

Important Information

Congratulations on choosing the RCA Custom Home Theatre system! Your decision to select this high quality, fully integrated system will give you years of entertainment enjoyment. Your system may include all or only some of the components listed. If your system does not have the component being explained, please skip to the next bit of information.

Please review this Owner's System Operating Guide for a brief introduction to your system. *For more detailed operating information about the advanced features and controls of your system, carefully read and follow the instructions in each component's owner's manual.*

Safety Precautions

- If your Custom Home Theatre system was built into a wall, it should have been installed in accordance with the appropriate building and electrical codes. **For extra precaution, a system disconnect switch may have been added. This switch is intended to be used in an emergency situation to shut down all electrical power to the system components. You should also locate and mark the circuit breaker to which the system is connected.**
- There are specific safeguards and precautions to follow for the TV, audio/video receiver, Laserdisc player, VCR, RCA satellite receiver (optional on some models), CD changer, and speakers. Please check each component's Owner's Manual or packed-in literature for safety precautions.

Product Information

Warranty Registration

Every RCA Custom Home Theatre system comes with a complete one-year in-home warranty. The Warranty Registration Form, included in the accessory kit, for your system must be filled out and sent in. If you do not have this form and are not sure if your installer filled it out, call 1-800-721-4007 to have a new form sent to you.

Keep Your Sales Receipts

To obtain warranty parts and service, you must show your sales receipt (or other evidence of purchase) to your Authorized RCA Servicenter. Therefore, keep your sales receipts and other papers with your owner's manuals. Do **not** mail sales receipts to Thomson Consumer Electronics.

Record Vital Information

Your installer should have recorded the model and serial number for each component in your system. Keep these numbers with your owner's manuals for service and identification purposes.

Note: Each Custom Home Theatre component has a special one-year in-home warranty. Please disregard the timing of the warranty printed in the owner's manual of each component.

To identify your nearest Authorized RCA Servicenter, ask your dealer, look in the yellow pages, or call 1-800-721-4007.

Table of Contents

Important Information	
Introduction, Safety Precautions, Product Information _____	i
Setting Up Your TV	
To Autoprogram TV's Channel Memory _____	2
To Add or Erase Channels from TV's Memory _____	2
To Set Up Channels for VCR, Laserdisc Player, and Satellite Receiver _____	3
Using Your TV	
To Watch a TV Program _____	4
To Set the Clock _____	4
To Use Picture-In-Picture (PIP) _____	5
Using Your System Remote Control	
Turning On Your System, Turning Off Your System _____	6
Component Buttons _____	7-12
Programming Your Remote	
Programming the Remote to Control Other Brands of Components _____	13
Remote Control Codes _____	14-15
Using Your Audio/Video Receiver	
To Listen to AM/FM Stations _____	16
To Preset AM/FM Stations _____	16
To Adjust Basic Sound Controls _____	16
To Set Surround Modes for Each Input _____	17
Setting Up Your VCR	
Setting Up the VCR Using the Interactive Guide _____	18
To Auto-Search Channels for the VCR's Channel Memory _____	18
To Add or Remove Channels from VCR's Channel Memory _____	19
To Set the Clock _____	19
Using Your VCR	
To Play Back a Videotape _____	20
To Record a Program _____	21
To Watch a TV Channel While VCR is Recording a Different Channel _____	21
Express Recording and Stopping Express Recording in Progress _____	22
Recording While You're Away and Timer Recording _____	23
VCR Plus+ Recording _____	24
Checking or Clearing a Timer or VCR Plus+ Recording _____	25
Using Your RCA DSS® Receiver (Optional with Some Systems)	
To Watch a Program and Point and Select Menu System _____	26
Channel Guide and Other Features Available Through the Menu System _____	27
Using Your Laserdisc Player	
To Play a Disc _____	28
Using Your CD Changer	
To Play a CD, To Select a Specific Disc, and To Select a Specific Track _____	29
Setting Up Your Speaker System	
To Test and Balance the Speaker System _____	30
Troubleshooting Guide	
Troubleshooting Checks _____	31-32
Index _____	33

Setting Up Your TV

Your TV must be programmed for the system to operate properly. If it was not programmed, complete these programming functions.

For complete operating information on your TV, see the User's Guide for your TV.

To Autoprogram TV's Channel Memory

1. Press TV on the remote to turn on the TV and audio/video receiver. Select an active channel on the TV. Adjust the volume, if necessary.
2. Press TV MENU on the remote repeatedly until Setup Menu is highlighted. Press + on the remote once and then press TV MENU repeatedly until Autoprogram is highlighted.
3. Press + to begin autoprogramming. The TV will first program all channels for ANT A input and then program all channels for ANT B input. (Do not press any buttons until the TV has finished autoprogramming itself.)

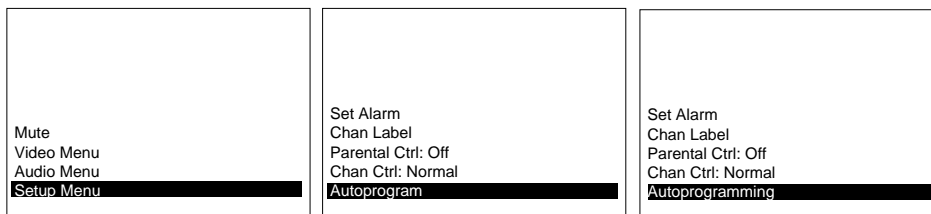

4. When the TV is finished cycling, you can check to see which channels are in memory by pressing CHANNEL up or down on the remote.

To Add and Erase Channels from TV's Memory

1. To add or erase a channel, repeatedly press TV MENU to highlight Setup Menu, and then press + or - to display the setup functions. Repeatedly press TV MENU to highlight the Chan Mem function.
2. Press CHANNEL up or down (or the two corresponding number buttons on the remote) to select the desired channel you wish to add or erase.
3. Press the + button to add the channel to memory, or press the - button to erase the channel from memory.

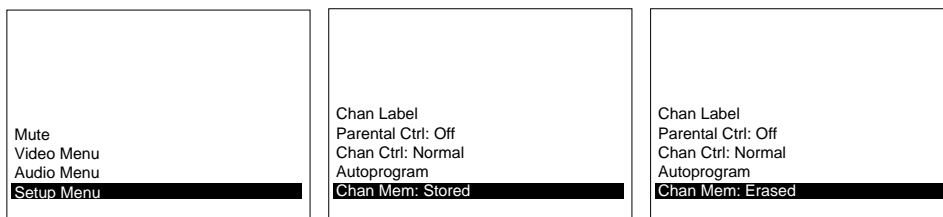

4. Be sure channel 91 has been added for the VCR, channel 92 has been added for the Laserdisc player, and channel 90 has been added if an optional satellite receiver is being used. Repeat steps 1-3 to add these channels. This lets you access these video inputs as regular channels when you press CHANNEL up or down.

To Set Up TV Channels for VCR, Laserdisc Player, and Satellite Receiver

To have your TV automatically turn on and tune to the proper channel for viewing the VCR, Laserdisc player, or satellite receiver when you press the corresponding button on the remote, set up the channels as explained below. When properly programmed the following will happen:

- Pressing **VCR1** on the remote will turn on the VCR, audio/video receiver, and TV, and tune the TV to channel 91 to view the picture from the VCR.
 - Pressing **VCR2•LD** on the remote will turn on the Laserdisc player, audio/video receiver, and TV, and tune the TV to channel 92 to view the picture from the Laserdisc player.
 - Pressing **DSS•CABLE** on the remote will turn on the satellite receiver, audio/video receiver, and TV, and tune the TV to channel 90 to view the picture from the satellite receiver.
1. Press **TV** on the remote to turn on the TV and audio/video receiver. Select an active channel on the TV. Adjust the volume, if necessary.
 2. Press **TV MENU** on the remote until **Setup Menu** is highlighted. Press the **+** button or **-** on the remote to display the setup functions, and then repeatedly press **TV MENU** to select **VCR1 Chan** function.

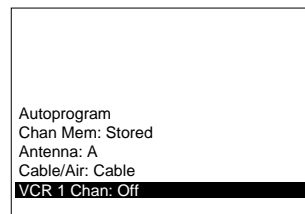
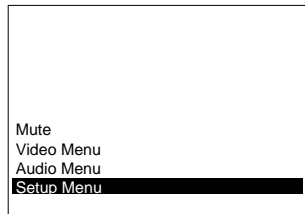

3. Press **9**, then **1**, to tune the TV to channel 91 — this is the channel to which the TV will tune automatically when you press the **VCR1** button on the remote.

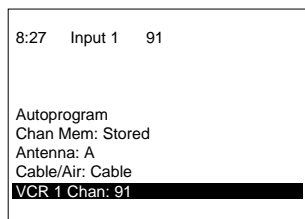

4. Press **+** to enter channel 91 for **VCR1 Chan**.
 - **Laserdisc player:** Repeat the above steps, substituting **VCR2 Chan** and pressing **9**, then **2**, for channel 92. Then press **+** to enter the channel.
 - **Satellite Receiver:** Repeat the above steps, substituting **Cable Chan** and pressing **9**, then **0**, for channel 90. Then press **+** to enter the channel.

Note: If you enter the wrong numbers, press the number buttons to enter the correct number.

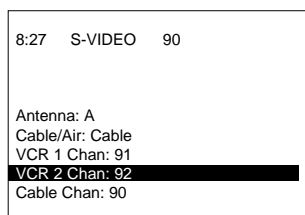

Using Your TV

To Watch a TV Program

1. Press TV on the remote to turn on the TV and audio/video receiver and set the remote to operate the TV.
2. Press CHANNEL up or down on the remote to scan up or down for an active channel or press two number buttons to go directly to a channel. To tune channels 100 and above, press and hold the number 1 button on the remote until 1-- is displayed on the screen. Then enter the other two numbers.
3. Press POWER twice on the remote to turn off the TV and audio/video receiver.

To Set the Clock

1. Repeatedly press TV MENU on the remote to highlight Setup Menu. Press the + or - button to display the setup functions. Repeatedly press TV MENU to highlight Clock Set.

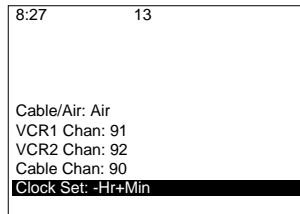
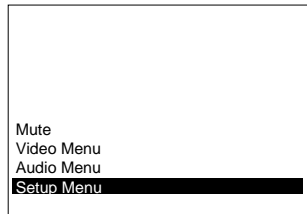

2. Press and hold the - button on the remote to select the correct hour (including AM or PM). Press and hold the + button on the remote to select the correct minute(s).

The correct time will now appear on the screen whenever you change channels or press TV on the remote.

To Use Picture-In-Picture (PIP)

1. Press TV and select the TV channel you want to watch.
2. Press PIP on the remote. A small picture will appear on the TV screen. The small and large picture will be the same.
3. Press the VCR1, or VCR2•LD, or DSS•CABLE button on the remote to see the picture from that component in the small PIP window.
4. Press TV to return the audio/video receiver to the TV mode.
5. While covering the end of the remote with your hand, press the button corresponding with the component you choose to view in the little picture (VCR1, VCR2•LD, DSS•CABLE). This will allow you to operate that component while leaving the audio/video receiver in the TV mode. Thus the audio will always be from the big picture.
6. To change channels on the picture from the TV, press TV on the remote and then press CHANNEL up or down or manually enter the channel with the number buttons. (PIP does not appear by the channel number on the TV screen when changing channels for the main picture.)
7. To swap the main picture with the small inset picture, press the SWAP PIP button on the remote.
8. In selected models, the small picture can be enlarged, reduced, or frozen. *See your Tv's User's Guide for complete details on using the remote that came with the TV.*

Using Your System Remote Control

All of the basic features of each of the system's components can be controlled with the system remote control (CRK67A1). Unless otherwise noted, all remote control references in this guide will be referring to the system remote control.

Turning On Your System

- Press the component button on the remote for the component you wish to control (TV, VCR1, VCR2•LD, DSS•CABLE, AM•FM, or CD). This will turn on that component and the A/V receiver. If it is a video component (TV, VCR1, VCR2•LD, or DSS•CABLE) it will also turn on the TV. All components needed will turn on and automatically tune to the correct inputs.

Note: If this does not happen, look at the troubleshooting guide in the back of this User's Guide.

Turning Off Your System

- Press **POWER** **once** on the remote to turn off the last component the remote was set to control.
- Press **POWER** **twice** on the remote within three seconds to turn off all of the components.

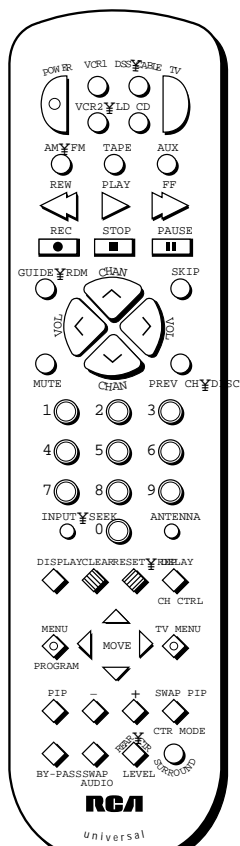

**System Remote
(CRK67A1)**

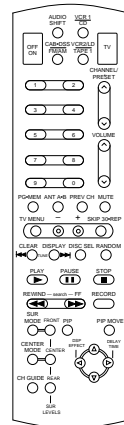

**Audio/Video Receiver
(CRK62S2)**

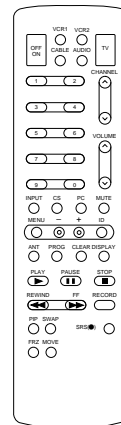

**TV
(CRK62)**

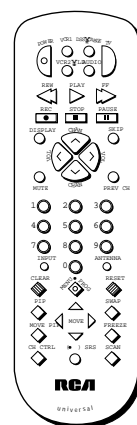

**TV
(CRK70)**

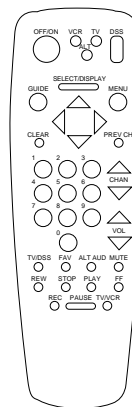

**Satellite Receiver
(CRK91B1)
(optional on some systems)**

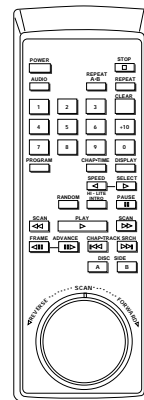

Laserdisc Player

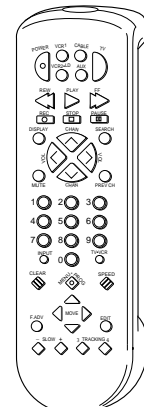

**VCR
(CRK70VB)**

Using Your System Remote Control

Universal Remote Control

Your RCA Universal Remote Control is capable of operating most RCA audio and video equipment. To use the remote control effectively, always aim it directly at your receiver.

The remote control operates on four batteries, included with your system. Install them before attempting to operate the remote. Be sure to match the + and - ends of each battery to the symbols shown in the remote's battery compartment.

Component Buttons

Press one of these buttons to turn on all of the system components needed to operate that component. This also puts the remote in the mode to operate that component.

AM•FM (Audio/Video Receiver) Turns on receiver and sets remote to control the receiver.

CD Turns on CD Changer and A/V Receiver and sets the remote to control the CD Changer.

DSS•CABLE Turns on the RCA Digital Satellite receiver, A/V receiver, and TV and sets the remote to control the DSS® System. If a Digital Satellite system is not used, this button can be used with the **POWER** button to turn on and operate a compatible cable box.

TV Turns on TV and A/V Receiver and sets the remote to control the TV.

VCR1 Turns on VCR, TV, and A/V Receiver and sets the remote to control the VCR.

VCR2•LD Turns on laserdisc player, TV, and A/V Receiver and sets the remote to control the laserdisc player.

These component buttons do not operate any of the basic components in this system.

AUX (Auxiliary) Can be coded to operate any component.

TAPE Turns on a compatible cassette tape player and sets the remote to control the tape player.

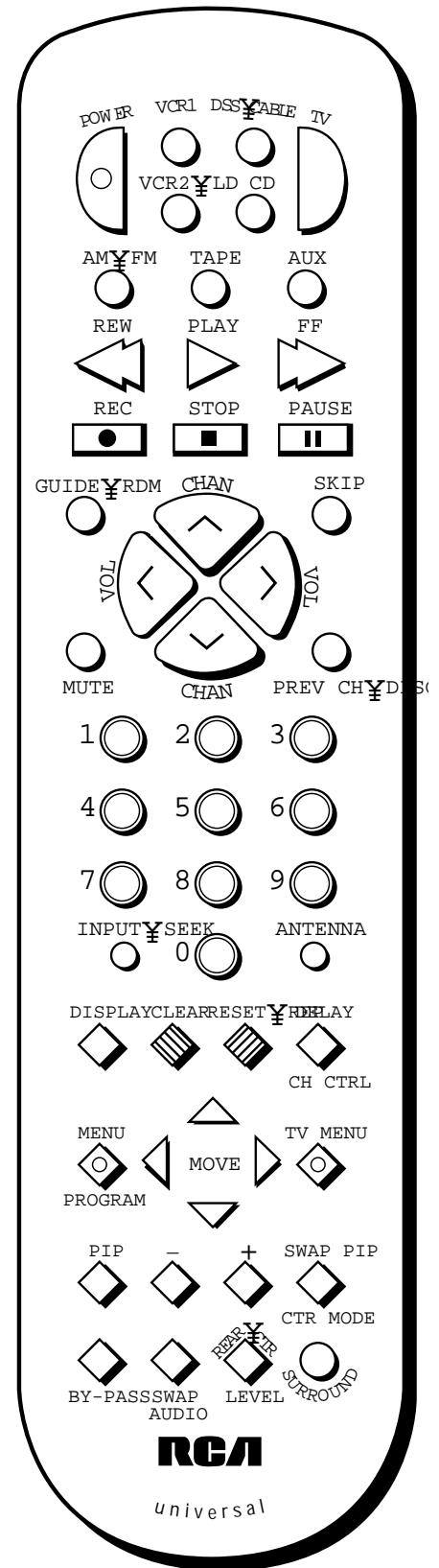

Buttons

TV Function

Press the TV button to turn on the TV and audio/video receiver and set the remote to operate the TV.

+ and - Used with the MENU button to select or adjust a function.

ANTENNA Changes the antenna input between ANT A and ANT B.

CHAN (Channel) Up or Down Selects next higher or lower channel in the TV's channel memory.

CLEAR Removes menus or status displays from the screen.

DELAY/CH CTRL Press to switch channel control between main picture and PIP picture.

DISPLAY Shows the status displays on the screen. Press repeatedly to see detailed program information, if available.

GUIDE•RDM Press to display previews of the channels in the channel list. It will show 12 channels at a time and sequence through all channels. Press the channel number of the channel you want to watch or press GUIDE•RDM again to remove the channel guide.

INPUT•SEEK Press to switch between inputs (90,91,92) and the TV's tuner.

MENU/PROGRAM Displays the main menu. Repeatedly press this button to highlight the menu item you want to access. Then press + or - to activate that menu or change that menu item.

MOVE Arrows (△▽◀▶) Moves the inset picture when the PIP function is on the screen.

MUTE Reduces the receiver's sound to its minimum level.

Numbers (0 through 9) Select a channel up to 99 by pressing two numbers. To select a cable channel over 99, press and hold 1 until 1-- appears on the screen. Then press the other two numbers.

PIP Brings up the small picture-in-picture window. Press again to remove the PIP window.

POWER Press once to turn off the TV. Press twice to turn off all components.

PREV CH•DISC Switches between the last two channels selected. Select one channel and then use the number buttons to select another. Press PREV CH•DISC to toggle between the two channels.

RESET•REP Resets the picture controls to their original factory setup.

SKIP Displays a count down timer on the screen. While this timer is on the screen you can change channels to see what else is on. When the timer reaches 0:00, the TV will automatically switch back to the channel it was on when the SKIP button was pressed. Press repeatedly to increase the amount of time.

SWAP AUDIO Not used in these systems.

SWAP PIP Swaps the main picture with the currently selected PIP picture.

TV Turns on the TV and puts the remote in TV mode.

TV MENU Displays the main menu. Repeatedly press this button to highlight the menu item you want to access. Then press + or - to activate that menu or change that menu item. Accesses the TV's menu no matter what mode the remote is in.

VOL (Volume) Up or Down Raises and lowers sound from the audio/video receiver.

Buttons

Audio/Video Receiver Function

Press the **AM•FM** button to turn on the receiver and set the remote to operate the receiver.

+ and – Used with **REAR•CTR LEVEL** button to adjust volume level of center and rear speakers.

AM•FM Turns on the receiver and toggles between AM and FM bands.

BY-PASS Turns By-Pass Mode on and off. By-Pass Mode cancels all surround modes and sound is produced with no surround effects.

CHAN (Channel) Up or Down Selects next higher or lower channel in the receiver's channel memory.

CTR (Center) MODE Press to toggle through the center channel modes (Normal, Wide, and Phantom) when Dolby^{*} Pro Logic or Cinema Surround mode is selected.

DELAY/CH CTRL Selects the amount of surround sound delay (15, 20, or 30 milliseconds) between the main and rear speakers.

MUTE Reduces the receiver's sound to its minimum level.

Numbers (0 through 9) Used to enter or change numbers for preset stations, and to directly access preset stations.

POWER Press once to turn off audio/video receiver. Press twice to turn off all components.

PREV CH•DISC Switches between the last two stations selected. Select one station, and then use the number buttons to select another. Press **PREV CH•DISC** to toggle between the two stations.

RESET•REP Used with number buttons to select or change number of preset station.

SURROUND Advances through surround modes: Pro Logic, Cinema, Theatre, Stadium, Studio, Rock, and Simulated.

REAR•CTR LEVEL Toggles between the volume level adjustment for the rear and center speakers. Use the + and – buttons to adjust volume of selected speaker(s).

VOL (Volume) Up or Down Raises and lowers volume of receiver.

* Dolby is a trademark of Dolby Laboratories Licensing Corp.

Buttons

VCR Function

Press VCR1 to turn on the VCR, audio/video receiver, and TV. The TV will tune to channel 91 (Input 1). This also sets the remote to operate the VCR.

ANTENNA Turns the VCR indicator on and off in the VCR's display panel. This has no effect when using this system.

Arrow Buttons (MOVE \triangle ∇) Allow you to move through the menus when they are displayed.

CHAN (Channel) UP or DOWN Selects next higher or lower channel in the VCR's channel memory.

CLEAR Resets time counter to 0:00:00. Allows you to change entries when setting the clock or VCR for a VCR Plus+ or a timer recording. Removes menus from the TV screen.

DISPLAY Press once to show the status displays on the TV screen. Press twice to keep the time counter on the TV screen. Press three times to remove all displays from the TV screen but leave the counter on the VCR display. Press four times to return to normal displays. Also used to edit timer programs.

FF (Fast Forward) Fast forwards the tape when the VCR is stopped. Searches the picture in forward motion during playback.

INPUT•SEEK Toggles between the line input (L1 or L2) and VCR's tuner. The line inputs are the audio/video input jacks on the back (L1) or front (L2) of the VCR.

MENU/PROGRAM Brings up the VCR MAIN MENU on the TV screen. Exits or removes a menu from the screen. Selects a menu item.

Numbers (0 through 9)

Select a channel up to 99 by pressing two numbers or a cable channel over 99 by pressing and holding 1 until 1-- appears on the screen. Then press the other two numbers. Also used to enter numbers when needed.

PAUSE Pauses action for viewing during playback. Pauses recording to prevent recording of unwanted scenes.

PLAY Starts the tape playing.

POWER Press once to turn off the VCR. Press twice to turn off all components.

PREV CH•DISC Switches between the last two channels selected. Select one channel and then use the number buttons to select another. Press PREV CH•DISC to toggle between the two channels.

REC Starts the VCR recording. Used for express recording (XPR).

REW (Rewind) Rewinds the tape when the VCR is stopped. Searches the picture in reverse motion during playback.

STOP Stops the normal functions such as record, playback, rewind, fast forward, and pause of the VCR.

Buttons

Laserdisc Player Function

Press **VCR2•LD** to turn on the laserdisc player, audio/video receiver, and TV. The TV will tune to channel 92 (Input 2). This also sets the remote to operate the laserdisc player.

ANTENNA Toggles between analog and digital audio on laser discs.

CHAN (Channel) UP or DOWN Selects next or previous track on laserdisc. Skips to next step during program playback.

CLEAR Clears an entry during programming.

DISPLAY Repeatedly press to show information about the disc that is playing. Number of displays and display information depend on the type of disc that is playing.

FF Scans forward on the laserdisc that is playing.

PAUSE Pauses a disc that is playing. Press **PLAY** to continue playing the disc from that point.

PLAY Starts the disc playing.

MENU/PROGRAM Displays and removes program menu from the TV screen. Use number buttons or **PAUSE** to enter your program. Use **CLEAR** to correct an entry.

Numbers (1 through 9) Used to enter the chapter (or track) number (1-9) you want to play. Used to enter the number of the chapters (or tracks) you want to play in the program menu.

POWER Press once to turn off laserdisc player. Press twice to turn off all components.

REW Scans backwards on the laserdisc that is playing.

STOP Stops the normal functions such as playback, search, repeat, program playback, and pause.

CD Changer Function Buttons

Press **CD** to turn on the CD changer and audio/video receiver and set the remote to control the CD changer. The **POWER** switch on the front of the CD changer must be left in the **ON** position. Since the CD changer is plugged into the switched outlet on the back of the audio/video receiver, it will turn on and off with the audio/video receiver.

STOP Stops the normal functions such as record, playback, rewind, fast forward, and pause of the VCR.

DISPLAY Switches between the time and track playback information.

FF (Fast Forward) Plays the next track on the disc that is playing.

GUIDE•RDM Plays tracks from one or all CDs in random order.

MENU/PROGRAM Used with the number buttons to program the CD changer.

Numbers (0 through 9) Used to enter track numbers for direct access or programming.

PAUSE Pauses the changer without interrupting current mode. Press **PLAY** to continue playing the disc from that point.

PLAY Starts a disc playing.

POWER Press once to turn off CD changer and audio/video receiver. Press twice to turn off all the components.

RCA DSS[®] Receiver Controls

ANTENNA Toggles between antenna input and RCA DSS[®] input.

CLEAR Removes all menus and guides from the screen.



CHAN (Channel) UP or DOWN Tunes to the next or previous channel when watching TV through the RCA DSS[®] System. Steps through one screen at a time when the program guide is on the screen.

DISPLAY (Also used as the **SELECT** button) Displays the RCA DSS[®] Channel Information header on the screen. While in the program guide, lets you select a program. Also, lets you select an option while in a menu.

DSS•CABLE Turns on the RCA DSS[®] Receiver, and puts the remote in RCA DSS[®] mode.

GUIDE•RDM Displays the program guide on the screen.

MENU/PROGRAM Activates the on-screen menu.

MOVE arrows (MOVE  ) Lets you point to different on-screen menu items when a menu is displayed on the screen. Lets you move through the program guide to highlight the program you want to watch.

Numbers (0 through 9) Lets you directly enter the numbers when needed for menu items or direct access to channels.

PREV CH•DISC Switches between the last two channels selected. Select one channel and then use the number buttons to select another. Press **PREV CH•DISC** to toggle between the two channels.

POWER Press once to turn off the RCA DSS[®] receiver. Press twice to off all the components.

Programming Your Remote

Programming Your Remote

You can program the universal remote to control most brands of remote controllable TVs, VCRs and cable boxes. If you have an RCA, GE or ProScan component, you may not need to program the remote at all. Other manufacturers' brands will need to be programmed.

Programming the Remote to Control Other Brands of Components

To determine whether you need to program the universal remote, turn on the component you want to operate, point the remote at the component's remote sensor and press the corresponding component button. Then, press the buttons (VCR1, DSS•CABLE, VCR2•LD, CD, AM•FM, TAPE) that will be used for that component to see if it responds to the remote commands. If not, you need to program the remote.

Follow these steps to program your universal remote:

1. Turn on the component.
2. Look up the brand and code number(s) for the type of component you are programming in the code lists on the next pages or on the code sheet packed with your remote.
3. Press and hold the component button on the remote.
4. While holding the component button, enter the three-digit code from the code list.
5. Release the component button, then press one of the commonly used buttons for that component to see if the component responds to the remote commands.

Note: There may be some functions on the remote that will not operate on another brand of component. Try several buttons to see if it is programmed correctly.

6. Repeat steps 3 through 5 using the next code listed for your brand until the component responds to the remote commands.

Programming the AUX Button

The AUX button can be programmed like an existing component button for a second TV, third VCR, second satellite receiver, or additional audio components.

Follow these steps to program the AUX button:

1. Turn on the component you want to program.
2. Look up the brand and corresponding code number(s) in one of the code lists on the previous pages.
3. Press and hold the AUX button on the remote. Then, press the other component button—AM/FM, TAPE, CD, DSS•CABLE, etc.
4. Release the component button, but **not** the AUX button.
5. Enter the three-digit code from the code list.
6. Release the AUX button, then press the POWER or CHAN up or down to see if the component responds to the remote commands. If it doesn't, press AUX, then POWER again.
7. Repeat steps 3 through 6 using the next code listed for the brand of your component until it responds to the remote commands.

Programming Your Remote

Remote Control Codes

Audio Equipment	
Brand	Code(s)
ads:	AMP001
Aiwa:	CD060
Akai:	AMP002,008
Denon:	CD057
Dynamic Bass:	AM/FM029
	CD025
	TAPE026,027
	PHONO028
Emerson:	CD066
Fisher	AMP023
	CD067
Hitachi:	CD063
JVC:	AMP016,058
	AM/FM030,035
	CD032
	TAPE033,034
	AUX031
Kenwood:	AMP017,074
	AM/FM074
	CD ...067,070,077
	TAPE071,072
	PHONO073
Kyocera:	AMP009
Lotte (NEC):	CD075
Magnavox:	AMP065
	AM/FM065
	CD061
Marantz:	AMP022,076
	AM/FM076
	CD068
Mitsubishi:	AMP015,059
	AM/FM059
Nakamichi:	AMP020
Onkyo:	AM/FM082
	CD078
	TAPE080,081
	PHONO079
Panasonic:	AMP012
	AM/FM038
	CD036,083
	TAPE037
Philips:	AMP062
	AM/FM062
	CD061
Pioneer:	AMP014
	AM/FM042
	CD039
	TAPE040,041
RCA:	AMP024
	AM/FM003
	CD ...007,043,044
	TAPE006
	PHONO005
	AUX004,054

Audio Equipment (cont.)	
Brand	Code(s)
Realistic:	CD063,066
Sansui:	CD045
Scott:	CD066
	TAPE055,056
Sherwood:	AMP011,013
Sony:	AMP021
	AM/FM049
	CD046
	TAPE048,053
	PHONO047
Teac:	AMP010
	CD069
Technics:	AM/FM052
	CD050
	TAPE051

Satellite Receivers	
Brand	Code(s)
Chaparral080,081
Cheyenne081
Drake082,083
General Instruments092,
093,094
RCA DSS®000
Realistic084
Sierra I,II,III081
STS1085
STS2086
STS3087
STS4088
Toshiba089
Uniden090
Video Cipher II091

Laserdisc Players	
Brand	Code(s)

Cable Boxes	
Brand	Code(s)
ABC022,046,053,054
Anvion007,008
Cablestar007,008
Diamond056
Eagle007,008
Eastern International002
General Instruments046
GI 400004,005,015,023,
024,025,030,036
Hamlin003,012,013,034,048
Hitachi037,043,046
Jerrold004,005,015,023,
024,025,030,036,
045,046,047,062,065
Macom037,043
Magnavox007,008,019,
021,026,028,029,
032,033,040,041
NSC009
Oak001,016,038
Oak Sigma016
Panasonic003,027,039,061
Philips007,008,019,021,026,
028,029,032,033,040,041
Pioneer018,020,044
Randtek007,008
RCA000,027
Regal003,012,013
Regency002,033
Samsung044
Scientific Atlanta003,022,035,
063,064
Signature046
Sprucer027
Starcom046
Stargate 2000058
Sylvania011,059
Teknika006
Texscan010,011,059
Tocom017,021,049,050,055
Unika031,032,041
Universal051,052,060
Viewstar007,008,019,021,026,
028,029,032,033,040,041
Warner Amex044
Zenith014,042,057,061

Televisions

Brand	Code(s)
Admiral005
Amtron064
Akai002,103
A-Mark102
Anam104,105
Anam National038,106
AOC011,019,027,088,107
Bell & Howell005
Candle011,027,033
Citizen011,027,033,064
Colortyme011,027,084
Concerto011,027
Contec/Cony036,037,040,042,064
Craig064
Curtis Mathes000,011,015,027,037
CXC064
Daewoo011,019,027
Daytron011,027
Dimensia000
Electrohome006,011,014,027,038,061,068
Emerson011,026,027,028,029,030,031,032,037,042,053,064,065,067,075,076,078,079,094,095,096
Envision011,027
Fisher017,021,039,041
Funai064
GE000,008,009,011,012,027,038,068,086,089,091
Goldstar003,004,006,011,019,027,037,050
Hallmark011,027
Hitachi009,011,027,036,037,040,047,048,063,080,094,097,098
Infinity013
JBL013
JCPenney000,008,011,019,027,040,068,077,086,088
Jensen011,027
JVC012,024,036,037,040,048,051,074
Kawasho002,011,027
Kenwood006,011,014,027
Kloss Novabeam035,043
KTV078
Loewe013
Luxman011,027
LXI000,013,018,021,023,054
Magnavox006,007,010,011,013,016,027,033,035,043,049,066,087,089
Marants013
Marantz011,013,027,069
Memorex005
MGA006,011,014,019,022,027,041,056,061,068
Mitsubishi006,011,014,019,022,027,041,055,056,061,068
MTC011,019,027
Multivision081
NAD018,023
NEC011,014,019,027,038,084
Panasonic012,013,038,086
Philco006,007,010,011,013,016,019,027,033,035,037,038,043,087,089
Philips002,006,007,010,011,013,016,033,035,037,038,043,066,073
Pioneer011,027,045,062,093
Portland011,019,027,037

Televisions (cont.)

Brand	Code(s)
ProScan000
Proton011,027,037,072
Quasar012,038,092
Radio Shack000,021,025,036,037,059,064,078
RCA000,006,011,019,027,034,038,044,046,088,100,101,109
Realistic021
Sampo011,027
Samsung006,011,014,015,019,027,036,037,077,110
Sanyo017,021,039,056,057,058
Scott028,037,064
Sears000,006,011,014,017,018,021,023,027,039,040,041,051,071,083,095
Sharp011,020,025,027,037,052,053,059,060,108
Signature005,094
Sony002
Soundesign011,027,033
Sylvania006,007,010,011,013,016,027,033,035,043,049,066,087,089
Symphonic064,076
Tatung038
Technics012
Techwood011,027
Teknika011,019,027,033,036,037,040,066
Telecaption090
TMK011,027
Toshiba018,021,023,040,071,077,085,090
Universal008,009
Victor051
Vidtech019,027
Wards000,005,006,007,008,009,010,011,013,019,025,027,028,035,043,059,066,076,082,089
Yamaha006,014,019,027
Zenith001,099

VCRs

Brand	Code(s)
Admiral006
Aiwa015
Akai003,017,022,023,063,066
Audio Dynamics014,016
Bell & Howell002
Broksonic010
Candle007,009,013,044,045,046,052
Canon008,053
Caphehart001
Citizen007,009,013,044,045,046,052
Colortyme014
Craig007,012
Curtis Mathes000,007,008,014,015,044,046,053,064,067
Daewoo013,045,052,076
dbx014,016
Dimensia000
Dynatech015
Electrohome027
Emerson008,009,010,013,015,020,023,027,034,041,042,047,049,057,062,065,067,068,070
Fisher002,012,018,019,043,048,058

VCRs (cont.)

Brand	Code(s)
Funai015
GE000,007,008,032,037,053
Goldstar009,014,046,060
Harman Kardon014
Hitachi005,015,035,036
Instant Replay008
JCL008
JCPenney002,005,007,008,014,016,030,035,051,053
JVC002,014,016,030,046,074
Kenwood002,014,016,030,044,046
KLH073
Lloyd's015
Logik031
Magnavox008,029,053,056
Marantz002,008,014,016,029,030,044,046,061
Marta009
MEI008
Memorex008,009,012,015
MGA004,027
Midland032
Minolta005,035
Mitsubishi004,005,027,035,040
Montgomery Ward006
MTC007,015
Multitech007,015,031,032
NEC002,014,016,030,044,046,059,061,064
Panasonic008,053,075,077
Pentax005,035,044
Pentax Research +046
Philco008,029,053,056
Philips008,029
Pioneer005,016,050
Portland044,045,052
ProScan000
Quartz002
Quasar008,053
RCA000,005,007,008,028,035,037,054,069
Radio Shack/Realistic002,006,008,009,012,015,019,027,043,053
Samsung007,013,022,032,042
Sansui016,071
Sanyo002,012
Scott004,013,041,049,068
Sears002,005,009,012,018,019,035,043,048
Sharp006,024,027,039,045
Shintom017,026,031,055
Signature015
Sony017,026,038
Sylvania008,015,029,053,056
Symphonic015
Tandy002,015
Tashiko009
Tatung030
Teac015,030,069
Technics008
Teknika008,009,015,021
TMK067
Toshiba005,013,019,048,049
Totevision007,009
Unitech007
Vector Research014,016,044
Victor016
Video Concepts014,016,044
Videosonic007
Wards005,006,007,008,009,012,013,015,025,027,031,035
Yamaha002,014,016,030,046
Zenith011,017,026,072

Using Your Audio/Video Receiver

The audio/video receiver tunes in the signals for AM and FM radio stations in your area, and controls the sound output for the TV, VCR, laserdisc Player, CD changer, and satellite receiver (optional for some systems).

To Listen to AM/FM Stations

1. Press **AM•FM** on the remote to turn on the receiver and set the remote to operate the receiver. Repeatedly press the **AM•FM** button to toggle between AM and FM mode.
2. Press **CHANNEL up** or **down** on the remote or **TUNING 2** or **1** on the receiver to tune the radio to a preferred station.

To Preset AM/FM Stations

1. Tune in the desired station by pressing **TUNING 2** or **1** on the receiver.
2. Press **MENU/PROGRAM** on the remote or **MEMORY** on the front of the receiver. While the word **MEMORY** is displayed in the display panel, press the number buttons to select the preset channel where the station is to be stored (01-30). For example, press **0** then **3** to store the station which is tuned to memory location 3.
3. Repeat steps 1 and 2 for up to 30 stations.
4. Once stations are preset, you can use **CHANNEL up** or **down** on the remote to scan through the preset channels. You can also go directly to preset stations using the number buttons.

To Adjust Basic Sound Controls

1. Press **VOLUME up (>)** or **down (<)** on the remote or adjust the **VOLUME** control on the receiver to increase or decrease the volume.

<p>Caution: To prevent speaker damage, make sure volume is turned down to a reasonable level before the receiver is turned on.</p>

2. Adjust the **BALANCE** control on the receiver to balance the level of sound from the left and right front speakers. The center position is recommended.
3. Adjust bass and treble. The bass and treble displays will flash during adjustment, and then time out.
 - To adjust bass, press **BASS** on the receiver and then press **up 2** to increase bass and **down 1** to decrease bass.
 - To adjust treble, press **TREBLE** on the receiver, and then press **up 2** to increase treble and **down 1** to decrease treble.

Using Your Audio/Video Receiver

To Set Surround Modes for Each Input

1. Press the Input you want to set the surround mode for. (TV, VCR1, VCR2•LD, DSS, etc.)
2. Set the surround mode by repeatedly pressing the SURROUND button on the remote or the SURROUND MODE button on the receiver until the surround mode you want is selected.
 - If the receiver does not toggle through the surround modes when you press the SURROUND button, press the BY-PASS button and then the SURROUND button.
3. Press 1 to Begin setup. Just follow the directions on the screen.
 - Once the surround mode has been selected, the receiver will always go to that surround mode when that input is selected.

Use this method to set up all inputs.

Setting Up Your VCR

There are several setup feature options for your VCR. The VCR has an Interactive Guide that will take you step-by-step through the setup options for your VCR. For complete operating information about your VCR, see the VCR user's guide.

Setting Up the VCR Using the Interactive Guide

1. Press VCR1 to turn on the VCR, audio/video receiver, TV, and tune the TV to channel 91 (Input 1). This also sets the remote to control the VCR.
2. Press MENU/PROGRAM on the remote to see the VCR MAIN MENU on the TV screen. Then press 5 to display the SETUP OPTIONS menu. Press 1 to display the first screen for the Interactive Guide.
3. Press 1 to Begin setup. Just follow the directions on the screen.

Note: If you use the interactive guide to set up the VCR, when finished you can skip forward to page 20 of this User's Guide.

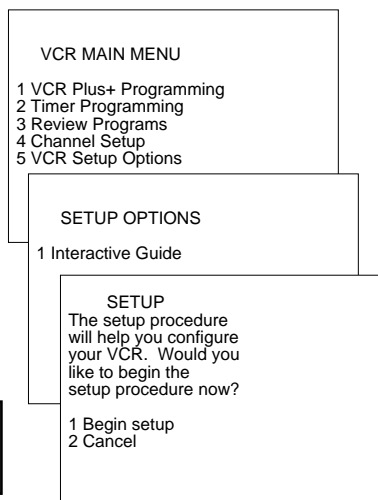

To Auto-Search Channels for the VCR's Channel Memory

If you do not use the Interactive Guide follow the directions below to place only the active channels in the VCR's channel memory.

1. Press VCR1 to turn on the VCR, audio/video receiver, TV, and tune the TV to channel 91 (Input 1). This also sets remote to control the VCR.
2. Press MENU/PROGRAM on the remote to see the VCR MAIN MENU on the TV screen.
3. Press 4 to display the CHANNEL SETUP menu.
4. Press 1 to begin Auto-Search Channels.
 - Wait until the channel numbers stop changing. This takes about one to two minutes. The VCR will then tune to the lowest channel found. Pressing CHANNEL up or down on the remote will select only the active channels.
 - The VCR will automatically select ANTENNA or CABLE for the Tuning Mode feature in the CHANNEL SETUP menu. If you need to change the setting manually, press 1 while in the CHANNEL SETUP menu.

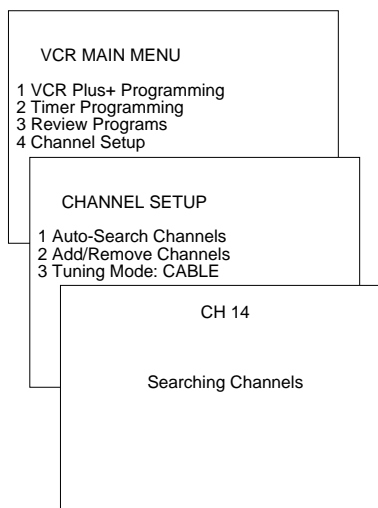

To Add or Remove Channels from VCR's Channel Memory

You may want to add or remove channels if some of the channels are not active, have weak signals, or you do not want to watch them.

1. Press **VCR1** to turn on the VCR, audio/video receiver, TV, and tune the TV to channel 91 (Input 1). This also sets the remote to control the VCR.
2. Press **MENU/PROGRAM** on the remote to display the **VCR MAIN MENU** on the TV screen.
3. Press **4** to display the **CHANNEL SETUP** menu.
4. Press **2** to display the **ADD/REMOVE CHANNELS** menu.
5. Enter the channel number or use **CHANNEL** up or down to tune to the channel you want to add or delete. Then follow the directions on the screen. Press **CLEAR** to remove the channel from the channel list and press **DISPLAY** to add the channel to the channel list.

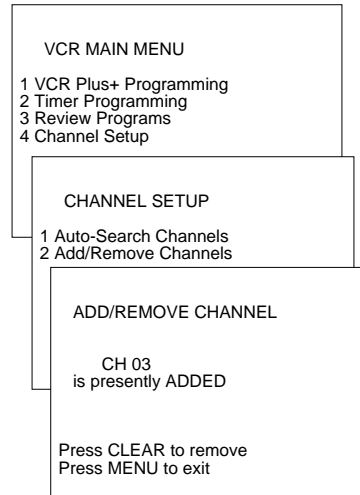

To Set the Clock

When you first turn on the VCR, --:-- appears in the clock area of the VCR's display panel. The clock must be set before you can use the VCR for express (XPR), VCR Plus+, or timer recordings.

1. Press **VCR1** to turn on the VCR, audio/video receiver, TV, and tune the TV to channel 91 (Input 1). This also sets the remote to control the VCR.
2. Press **MENU/PROGRAM** on the remote to display the **VCR MAIN MENU** on the TV screen.
3. Press **6** to display the **SET VCR CLOCK** menu.
4. Enter the time and date with the number buttons on the remote.
 - Press **0** before single-digit numbers. For example, press **0**, then **5**, then **0**, then **7** for a time of 5:07. Press **1** for AM or **2** for PM.
 - Press **CLEAR** on the remote to change incorrect entries.
5. Press **MENU/PROGRAM** on the remote twice to remove the **SET VCR CLOCK** and **VCR MAIN MENU** from the TV screen and start the clock.

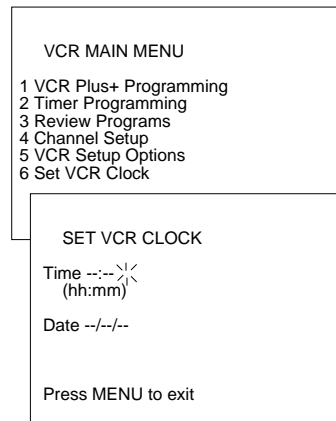

The time will appear in the VCR's display panel and the time and date will appear on the TV screen whenever you press **DISPLAY** while in the VCR mode.

Using Your VCR

To Play Back a Videotape

1. Press VCR1 on the remote to turn on the VCR, audio/video receiver, TV, and tune the TV to channel 91 (Input 1). This also sets the remote to control the VCR.
2. Insert a pre-recorded tape in the VCR. The VCR automatically turns on, and the cassette-in  indicator lights. The tape automatically begins playback if the safety tab on the cassette has been removed and the Auto Play feature is turned on.
3. Press PLAY, if necessary. PLAY will appear in the VCR's display panel while the tape is playing.



- If necessary, press TRACKING up or down on the VCR or VCR's remote (the remote which came packed with the VCR) to remove any streaks from the picture.
 - While a tape is playing press PAUSE to pause the action and view one frame of the picture. Press PAUSE or PLAY to return to normal playback.
 - While a tape is playing press FF to visually search the tape forward or press REW to visually search the tape in reverse. Press the FF or REW button again or press PLAY to resume watching the tape.
4. Press STOP when you are finished watching the tape.
 5. Press REW to rewind the tape. The VCR automatically rewinds the tape if it reaches the end of the tape during playback. While rewinding you can press POWER on the remote or on the VCR and the VCR will turn off after rewinding.
 6. Press EJECT on the VCR to eject the tape.

To Record a Program

1. Insert a blank tape with safety tab in place.
2. Press **VCR1** on the remote to turn on the VCR, audio/video receiver, TV, and tune the TV to channel 91 (Input 1). This also sets the remote to control the VCR.
3. Select a recording speed (SP, LP, or SLP) using the **SPEED** button on the VCR or VCR's remote. The tape speed indicator appears in the VCR's display panel and on the TV screen.
 - **SP (Standard Play)** gives the best quality recording. Special effects such as pause, slow motion, picture search, and frame advance work well in this speed.
 - **LP (Long Play)** gives twice the recording time of tapes recorded in SP. Special effects in playback do not work well LP.
 - **SLP (Super Long Play)** gives three times the recording time of tapes recorded in SP. Special effects such as pause, slow motion, picture search, and frame advance work well in this speed.

Cassette	Recording Time		
	SP	LP	SLP
T-120	2Hrs	4Hrs	6Hrs
T-160	2Hrs 40Mins	5Hrs 20Mins	8Hrs

4. Press **CHANNEL** up or down on the remote to select the channel to be recorded. The channel number appears in the VCR's display panel and on the TV screen. If recording from a component, that component will have to be connected to the **INPUT** jacks on the back of the VCR and the VCR needs to be tuned to L1.
5. Press **REC** on remote to begin recording. **REC** appears in the VCR's display panel while the VCR is recording.

To Watch a TV Channel While VCR is Recording a Different Channel

1. Follow steps 1 through 5 above.
2. Press **TV** on the remote to set the remote to control the TV.
3. Press **CHANNEL** up or down on the remote to select the TV channel you want to watch. The channel number appears on the TV screen.

Express Recording (XPR)

Express recording lets you record up to four hours without using the timer program feature. The VCR will turn off automatically at the end of the recording.

1. Press **VCR1** on the remote to turn on the VCR, audio/video receiver, TV, and tune the TV to channel 91 (Input 1). This also sets the remote to control the VCR.
2. Insert a blank tape with safety tab in place.
3. Select a recording speed (SP, LP, or SLP) using the **SPEED** button on the VCR or VCR's remote.
4. Press **CHANNEL** up or down on the remote to select the channel to be recorded.
5. Press **REC** on the remote once to activate normal recording. Repeatedly press **REC** until the amount of express recording time is displayed on the TV screen. Each press of **REC** increases the time 30 minutes up to 4 hours.

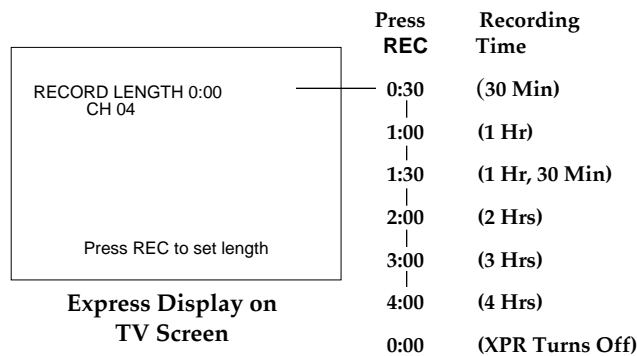

6. Press **REC** to display the time remaining on the TV screen. Press **REC** again to increase the amount of recording time.

Stopping an Express Recording in Progress

1. Press **VCR1** and then **STOP** within a few seconds on the remote or press **POWER** and then **STOP** within a few seconds on the VCR.

Recording While You're Away

Timer and VCR Plus+ recordings let you program the VCR to record up to eight different programs within a one-year period. Before recording, make sure that:

- The clock is set correctly.
- A tape with safety tab has been inserted with enough tape to record the program(s).

Timer Recording

1. Press VCR1 on the remote to turn on the VCR, audio/video receiver, TV, and tune the TV to channel 91 (Input 1). This also sets the remote to control the VCR.
2. Press MENU PROGRAM on the remote to display the VCR MAIN MENU.
3. Press 2 to select the Timer Programming menu.
4. Press 1, 2, 3, or 4 to select type of program.
 - 1 One time — single program recorded once.
 - 2 Daily — program recorded at same time every day.
 - 3 Weekdays — program recorded at same time Monday through Friday.
 - 4 Weekly — program recorded at same time once a week.
5. Press number buttons on the remote to enter the channel number, start time including AM or PM, end time, and start date of the recording. Just follow the on-screen prompts. Press CLEAR to correct an entry.
6. Select recording speed using the SPEED button on the VCR's remote or on the VCR.
7. Press MENU PROGRAM to enter your program. A reminder appears which times out or you can press MENU PROGRAM to return to the VCR MAIN MENU. PROGRAMS OVERLAP may appear on the screen if you have entered two programs where the times overlap.
8. Repeat steps 2–7 for additional programs or press MENU PROGRAM to remove the menu from the TV screen.
9. Turn off the VCR before the recording is scheduled to begin. TIMER appears in the VCR's display panel when the timer has been programmed.

Stopping a Timer Recording in Progress

1. Press VCR1 and then STOP within a few seconds on the remote or press POWER and then STOP within a few seconds on the VCR.

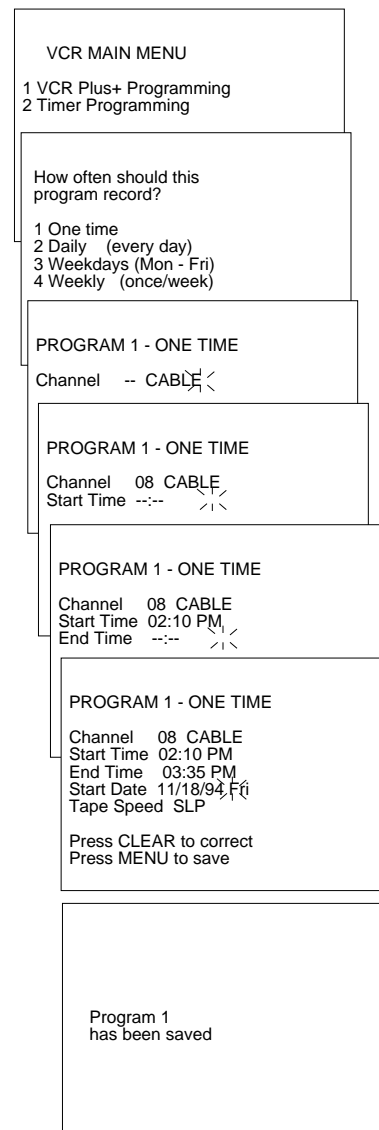

VCR PLUS+* Recording

Make sure the VCR has been set up for VCR Plus+ programming. See VCR's User's Guide.

1. Press VCR1 on the remote to turn on the VCR, audio/video receiver, TV, and tune the TV to channel 91 (Input 1). This also sets the remote to control the VCR.
2. Press MENU PROGRAM on the remote to display the VCR MAIN MENU.
3. Press 1 to display the VCR PLUS+ menu.
4. Press numbers on the remote to enter the PlusCode* number for the program you want to record. VCR PlusCode numbers are found in most local TV listings.

Press CLEAR on the remote to correct an entry.

5. Press MENU PROGRAM to enter the program.
If the VCR does not recognize the PlusCode number, Unrecognized number... Please re-enter appears on the TV screen. Check the number and enter it again.

6. Press 1, 2, 3, or 4 to select type of program.
 - 1 One time — single program recorded once.
 - 2 Daily — program recorded at same time every day.
 - 3 Weekdays — program recorded at same time Monday through Friday.
 - 4 Weekly — program recorded at same time once a week.

7. Select recording speed using the SPEED button on the VCR's remote or VCR.

8. Optional: You may extend the recording time of VCR Plus+ programs. This option may be useful when recording programs such as sporting events that could go past scheduled broadcast times. To change the program's End Time, press CLEAR repeatedly to erase the program End Time, then enter the new time.

9. Press MENU PROGRAM to enter your program. A reminder appears which will time out or you can press MENU PROGRAM to return to the VCR MAIN MENU.

PROGRAMS OVERLAP may appear on the screen if you entered two programs where the times overlap.

10. Repeat steps 2 – 9 for additional programs or press MENU PROGRAM to remove the menu from the TV screen.

11. **Turn off the VCR** before the recording is scheduled to begin. TIMER appears in the VCR's display panel when the timer has been programmed.

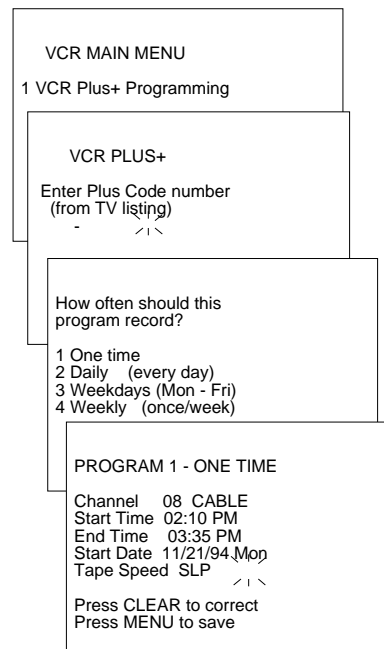

Stopping a VCR Plus+ Recording in Progress

1. Press VCR1 and then STOP within a few seconds on the remote or press POWER and then STOP within a few seconds on the VCR.

*VCR Plus+ and PlusCode are trademarks of Gemstar Development Corporation.

Checking or Clearing a VCR Plus+ or Timer Recording

1. Press VCR1 on the remote to turn on the VCR, audio/video receiver, TV, and tune the TV to channel 91 (Input 1). This also sets the remote to control the VCR.
2. Press MENU PROGRAM on remote to display VCR MAIN MENU on TV screen.
3. Press 3 for Review Programs. The black highlights the area for review.
4. Follow the on-screen prompts for checking or clearing the programs.

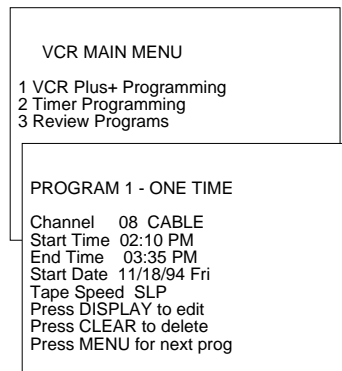

Using Your DSS[®] Receiver (optional with some systems)

If your system came with, or you have added, an RCA Digital Satellite System, you can press the DSS•CABLE on the remote and the DSS[®] receiver, audio/video receiver, and TV will turn on and the TV will tune to channel 90 (S-Video Input).

For more detailed instructions see the satellite receiver user's manual.

To Watch a Program

1. Press DSS•CABLE on the remote to turn on the satellite receiver, audio/video receiver, TV, and tune the TV to channel 90 (S-Video Input). This also sets the remote to control the satellite receiver.
2. Press CHANNEL up or down to select channels, or press number buttons to directly access a channel. To find a channel using the on-screen channel guide, see the next page.

Point and Select Menu System

The receiver has interactive menus and operating guides that use the "Point and Select" method.

1. Press DSS•CABLE on the remote to turn on the satellite receiver, audio/video receiver, TV, and tune the TV to channel 90. This also sets the remote to control the satellite receiver.
2. Press MENU/PROGRAM to display the DSS Main Menu.

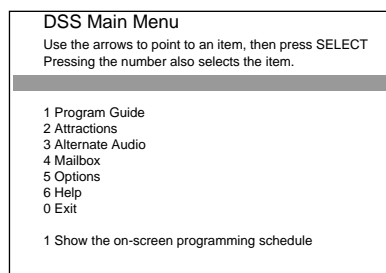

3. "Point" to the item you want to select using the arrow buttons at the bottom of the remote.
4. "Select" the item using the DISPLAY button on the remote.
5. Follow the on-screen instructions.

Note: You can also select a menu item by pressing the corresponding number on the remote. Press CLEAR on the remote to remove a menu from the screen.

Note: Whenever the on-screen display says to press the SELECT button, you must press the DISPLAY button on the system remote.

*DSS[™] is a trademark of DIRECTV, Inc., a unit of GM Hughes Electronics.

Channel Guide

1. Press **DSS•CABLE** on the remote to turn on the satellite receiver, audio/video receiver, TV, and tune the TV to channel 90 (S-Video Input). This also sets the remote to control the satellite receiver.
2. Press the **GUIDE•RDM** button on the remote to display the channel guide.

Program Guide					
Channel	7:30PM	8:00PM	8:30PM	9:00PM	9:30PM
122					
123					
124					
125					
126					
3	Movies	Sports	Other	All	Exit

3. Point to the 3 arrow with the arrow buttons on the remote and press **DISPLAY** to scroll down the Program Guide.
 - Point to one of the other categories (movies, sports, other, or ALL) to display only that type of program.
 - Select **ALL** to return to the original Program Guide.

Note: Press **CLEAR** on the remote to remove a menu from the screen.

Other Features Available Through the Menu System

The menu system offers you access to many more features. Some of the major features are:

- Select pay-per-view programs and coming attractions.
- Receive on-screen mail messages from your program provider.
- Customize your own channel lists.
- Set spending and rating limits and then lock the system to enforce those limits.
- Help menus.

See your DSS[®] Owner's Manual for more details.

Using Your Laserdisc Player

If your system came with a laserdisc player, follow the directions below to help you with the most common functions. For complete operating information about your laserdisc player, see the player user's guide.

To Play a Disc

1. Press **VCR2•LD** on the remote to turn on the laserdisc player, audio/video receiver, TV, and tune the TV to channel 92. This also sets the remote to operate the laserdisc player.
2. Press **OPEN•CLOSE** on the player to open the disc table.
3. Load a disc as shown below.

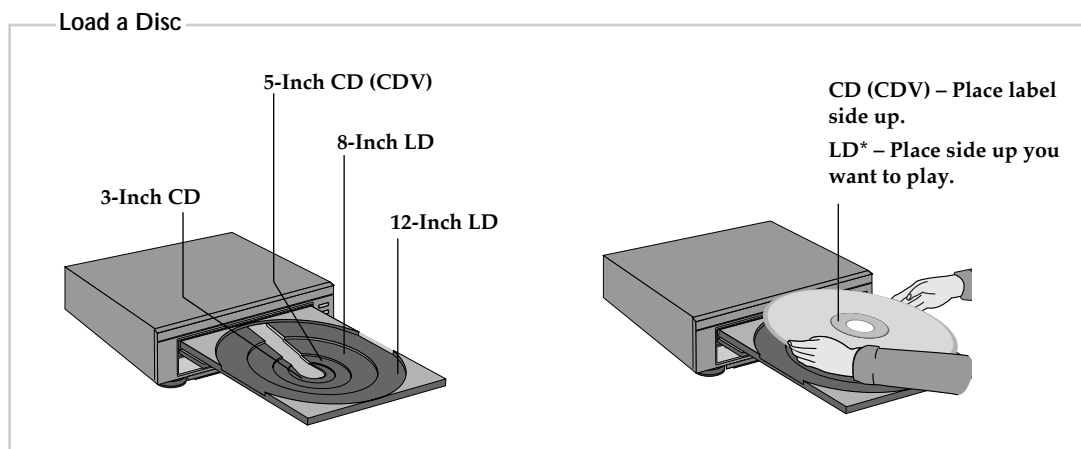

* On two-sided disc, the side facing up will play first and then the other side will play.

4. Press **PLAY** on the remote or **PLAY•PAUSE** on the player to close the disc table and start the disc playing.
 - To play only one side of the disc, press **SIDE A** or **B** on the player. The side selected will play, and then playback will stop.
 - Repeatedly press **DISPLAY** on the remote when a disc is playing to display information about the disc on the TV screen.
 - Press **PAUSE** on the remote to stop the action when a disc is playing. Press **PLAY** to return to normal playback.

CAUTIONS

Loading more than one disc or loading a disc incorrectly may cause damage to the disc and disc player.

Center the disc properly in the groove corresponding to the size of the disc.

Place only one disc on the disc table at a time.

Do not use adapters with this disc player.

Do not place any objects other than a disc on the disc table.

Do not move the player while a disc is playing. This may cause the disc to be scratched.

Do not let children put their hands into the disc player when the table is open. This may cause injury.

Using Your CD Changer

For complete operating information about your CD changer, see the CD changer's User's Guide.

To Play a CD

1. Press **CD** on the remote to turn on the CD changer and audio/video receiver. This also sets the remote to operate the CD changer.

Note: If the CD changer does not turn on when you press the **CD** button, check to make sure that the **POWER** button on the front of the changer is pressed into the on position.

2. Press **OPEN/CLOSE** on the CD changer to open disc tray. Load disc with the label side up in the disc tray.
To load more discs press **SKIP** on the changer to rotate the carousel and load up to five discs at one time.
3. Press **PLAY**. The changer will begin playing the lowest number disc in the tray and continue to play until all of the discs are played.
4. Press **STOP** when you are finished playing the disc.

To Select a Specific Disc

1. Press **CD** on the remote to place the remote in the CD mode.
2. Press **PREV CH•DISC** and then the disc number on the remote or **DISC NUMBER** on the changer to select a specific disc.

To Select a Specific Track

1. Press **CD** on the remote to place the remote in the CD mode.
2. During playback, press the **REW** button to return to the beginning of the track that is playing. Repeatedly press **REW** to return to the beginning of previously played tracks.
Press the **FF** button to advance to the beginning of the next track. Repeatedly press **FF** to advance one track for each press.

Setting Up Your Speaker System

Each of your speakers were designed to deliver unique audio characteristics to your Custom Home Theatre system. When combined, they reproduce a clear, crisp sound for such diverse audio sources as movie soundtracks and compact discs.

In addition to the variety of speakers, there are other audio options provided with the system such as:

- Seven Surround Modes — Theatre, Stadium, Studio, Rock, Simulated, Pro Logic Surround, and CINEMA
- Five Digital Sound Processing Effects — Room Size, Initial Delay, Liveness, Low Pass Filter, and Reverberation
- Speaker System Combinations — Main, Rear Surround, and Center

Note: Front surround speakers are not included with the system, but the system does have the capability.

Your personal preference will determine which combinations are best for your listening situations. It is suggested that you carefully read the information in your audio/video receiver's User's Guide for complete operating information.

To Test the Speaker System

1. To make sure all speakers are activated, your receiver must be in the Pro Logic or CINEMA mode.
2. Press the TEST button on the receiver. The receiver will generate pink noise (static noise) and apply it automatically at two-second intervals to the left main channel, center channel, right main channel, and simultaneously to the left and right rear channels in that order.
3. Position yourself in your normal viewing area and compare noise volume levels. They should be adjusted to approximately equal the level of output from the left and right main speakers.

To Balance the Speaker System

1. Repeatedly press REAR•CENTER on the remote to toggle between the REAR SPEAKER and CENTER SPEAKER level adjustment displays. While display is flashing press + or - to adjust the level.
2. Press TEST again to return to normal audio.

Troubleshooting Checks

Trouble

Here's What to Try

No Power

- Make sure all components are plugged in as instructed in the Installation & Hookup Guide.
- Check circuit breaker for the wall outlet.
- If a disconnect switch was added to the system, but sure it is in the ON position.

Remote locks up or doesn't work at all

- Remove batteries for 2 minutes then reinstall the batteries and try remote again.
- Maybe batteries were installed incorrectly. Remove batteries and reinstall correctly.

CD changer will not turn on with remote

- Make sure POWER switch on the front of CD changer is on.
- Make sure CD changer's power cord is plugged into the back of the audio/video receiver.
- Make sure audio/video receiver is turned on.

CD changer is always turned on with audio/video receiver

- This is how the system operates since the CD changer is plugged into the back of the audio/video receiver.

Remote won't control the audio/video receiver, laserdisc player, CD Changer, VCR, or satellite receiver

- Remove batteries for 2 minutes then reinstall the batteries and try remote again.
- Maybe batteries are weak. Try new batteries.

Trouble

Here's What to Try

No Video from VCR or laserdisc player

- Make sure TV is in the correct input. If the TV does not go to the correct input when the VCR1, VCR2•LD, or DSS•CABLE button on the remote are pressed, refer to the Test the System section of the Installation and Hookup Guide for proper programming of the components.
- Make sure all cables are connected as shown in the Installation and Hookup Guide.

Can't get TV channels

- After pressing the TV button on the remote, you must enter the channel you wish to watch or press Channel up or down on the remote.

Can't record from laserdisc player

- The system is not configured to record from the laserdisc player onto the VCR. To record from the laserdisc player you must remove the two-wire cable from the TV that comes from the laserdisc player. This then gets connected to R & L inputs on the back of the VCR. An additional video cable will then need to be connected from the Video Out 2 of the laserdisc player to the Video Input of the VCR. The VCR must then be put into the L1 input mode. This can be done by pressing the VCR1 button on the remote and then the INPUT•SEEK button.

VCR or laserdisc player won't turn on the first time you press the VCR1 or VCR2•LD buttons on the remote

- Make sure the power cords of all the components are connected as shown in the Installation and Hookup Guide.

Index

Add Channel, TV's Channel Memory	2	While You're Away	23
Add Channel, VCR's Channel Memory . . .	19	Express (XPR)	22
AM/FM Stations		Timer	23
Listen to	16	VCR Plus+	24
Preset	16	Remote Control, Buttons	7-12
Audio, Adjust	16	Remote Control, Codes	14-15
Auto-Search Channels, VCR	18	Remote Control, Using	6
CD Changer		Safety Precautions	i
Play a CD	29	Set the Clock, TV	4
Select a Specific Disc or Track	29	Set the Clock, VCR	19
Checking Timer & VCR Plus+ Programs . .	21	Set Up Channels for VCR, Laserdisc Player and Satellite Receiver	3
Contents	1	Speaker System	17
DSS [®] Satellite System	26-27	Surround Modes	17
Erase Channel, TV's Channel Memory	2	System	
Erase Channel, VCR's Channel Memory . .	19	Remote Control	6
Express Recording		Turning On and Off	2
Setting	22	Table of Contents	1
Stopping	22	Timer Recording	
Important Information	i	Checking and Clearing	25
Information, Warranty	i	Setting	23
Introduction	i	Stopping	23
Laserdisc Player		TV	
Playing a Disc	28	Autoprogram Channels	2
PIP (Picture-in-Picture)	5	Add or Erase Channels	2
Play a CD	29	Set the Clock	4
Play a laserdisc	28	Set Up the VCR, Laserdisc Player, and Satellite Receiver Channels	3
Play a Tape	20	Watch a Program	6
Product Information	i	Using the Remote Control	6
RCA DSS [®] Satellite System		VCR	
Channel Guide	27	Auto-Search Channels	18
Point and Select Menu System	26	Add or Erase Channels	19
Watch a Program	26	Interactive Guide	18
Recording		Play a Tape	20
A Program	21	Set the Clock	19
One Program While Watching Another .	21	Recording	21
Speeds	21	VCR Plus+ Recording	
		Checking and Clearing	25
		Extending Program Time	24
		Setting a Recording	24
		Stopping	24



 **THOMSON CONSUMER ELECTRONICS**

10330 North Meridian Street, Indianapolis, IN 46290

©1995 Thomson Consumer Electronics, Inc.

Printed in USA

Trademark(s) ® Registered Marca(s) Registrada(s)

TOCOM 15099470

Free Manuals Download Website

<http://myh66.com>

<http://usermanuals.us>

<http://www.somanuals.com>

<http://www.4manuals.cc>

<http://www.manual-lib.com>

<http://www.404manual.com>

<http://www.luxmanual.com>

<http://aubethermostatmanual.com>

Golf course search by state

<http://golfingnear.com>

Email search by domain

<http://emailbydomain.com>

Auto manuals search

<http://auto.somanuals.com>

TV manuals search

<http://tv.somanuals.com>