

It's important to read this instruction prior to using your new product for the first time.

FCC Information

This device complies with part 15 of the FCC Rules. Operation is subject to the following two conditions: (1) This device may not cause harmful interference, and (2) this device must accept any interference received, including interference that may cause undesired operation.

This equipment has been tested and found to comply with the limits for a Class B digital device, pursuant to part 15 of the FCC Rules. These limits are designed to provide reasonable protection against harmful interference in a residential installation. This equipment generates, uses and can radiate radio frequency energy and, if not installed and used in accordance with the instructions, may cause harmful interference to radio communications.

However, there is no guarantee that interference will not occur in a particular installation. If this equipment does cause harmful interference to radio or television reception, which can be determined by turning the equipment off and on, the user is encouraged to try to correct the interference by one or more of the following measures:

- Reorient or relocate the receiving antenna.
- Increase the separation between the equipment and receiver.
- Connect the equipment into an outlet on a circuit different from that to which the receiver is connected.
- Consult the dealer or an experienced radio / TV technician for help.

WARNING: Changes or modifications to this unit not expressly approved by the party responsible for compliance could void the user's authority to operate the equipment.



This Home Theater has earned the ENERGY STAR.

Ventilation

You must adequately ventilate the product. Make sure there is adequate space around the unit to provide proper air flow for ventilation. See diagram.

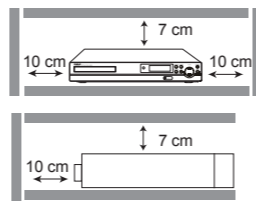

This product complies with DHHS Rules 21 CFR Subchapter J. Applicable at the date of manufacture.

For your safety

The AC power plug is polarized (one blade is wider than the other) and only fits into AC power outlets one way. If the plug won't go into the outlet completely, turn the plug over and try to insert it the other way.

If it still won't fit, contact a qualified electrician to change the outlet, or use a different one. Do not attempt to bypass this safety feature.

Removing the power plug is the only way to completely remove power from your product. Make sure the power plug remains easily accessible.

Note

This DVD player is designed and manufactured to correspond to the Region Management Information. If the Region number of a DVD disc does not correspond to the Region number of this DVD player, this player cannot play the disc. The Region number for this DVD player is Region 1.

FCC Information



WARNING: TO REDUCE THE RISK OF ELECTRIC SHOCK, DO NOT REMOVE COVER (OR BACK). NO USER-SERVICEABLE PARTS INSIDE. REFER SERVICING TO QUALIFIED SERVICE PERSONNEL.

CAUTION: USE OF CONTROLS OR ADJUSTMENTS OR PERFORMANCE OF PROCEDURES OTHER THAN THOSE SPECIFIED MAY RESULT IN HAZARDOUS RADIATION EXPOSURE.

CAUTION: DANGER OF EXPLOSION IF BATTERY IS INCORRECTLY REPLACED. REPLACE ONLY WITH THE SAME OR EQUIVALENT TYPE.

WARNING: MAINS PLUG IS USED AS DISCONNECT DEVICE AND IT SHOULD REMAIN READILY OPERABLE DURING INTENDED USE. IN ORDER TO DISCONNECT THE APPARATUS FROM MAINS COMPLETELY, THE MAINS PLUG SHOULD BE DISCONNECTED FROM THE MAINS SOCKET OUTLET COMPLETELY.

Caution

This product utilizes a laser. Use of controls or adjustments or performance of procedures other than those specified may result in hazardous radiation exposure. Do not open covers and do not repair yourself. Refer servicing to qualified personnel. Visible and invisible laser radiation when open and interlocks defeated. DO NOT STARE INTO BEAM.

Class 1 laser product



CLASS 1 LASER PRODUCT
APPAREIL A LASER DE CLASSE 1
PRODUCTO LASER DE CLASE 1

Illustrations contained in this document are for representation only.

THE LIGHTNING FLASH AND ARROWHEAD WITHIN THE TRIANGLE IS A WARNING SIGN ALERTING YOU OF "DANGEROUS VOLTAGE" INSIDE THE PRODUCT. THE EXCLAMATION POINT WITHIN THE TRIANGLE IS A WARNING SIGN ALERTING YOU OF IMPORTANT INSTRUCTIONS ACCOMPANYING THE PRODUCT.

Please respect the environment and prevailing regulations. Before you dispose of batteries or accumulators, ask your dealer whether they are subject to special recycling and if they will accept them for disposal.



This class B digital apparatus complies with Canadian ICES-003. Cet appareil numérique de la classe B est conforme à la norme du NMB-003 du Canada.

WARNING

To reduce the risk of fire or electric shock hazard, do not expose this product to rain or moisture. The apparatus shall not be exposed to dripping or splashing and that no objects filled with liquids, such as vases, should be placed on the apparatus.

Important Information

Service information

This product should be serviced only by those specially trained in appropriate servicing techniques.

Important battery information

- Do not mix different types of batteries or new and old batteries. Do not use rechargeable batteries.
- In order to avoid any risk of explosion, observe the polarities indicated inside the battery compartment. Replace only with the type of batteries specified. Do not dispose of them in a fire or recharge them.
- If you are not using the remote control for a long period of time, remove the batteries.

DVD copy protection

In accordance with the DVD standard, your DVD player is equipped with a Copy Protection system, which can be switched on and off by the DVD disc itself, in order to make any recording of the relevant DVD disc onto a videotape of very poor picture quality, or even impossible. This product incorporates copyright protection technology that is protected by method claims of certain U.S. patents and other intellectual property rights owned by Macrovision Corporation and other rights owners. Use of this copyright protection technology must be authorized by Macrovision Corporation, and is intended for home use only unless otherwise authorized by Macrovision Corporation. Reverse engineering or disassembly is prohibited.

Important Safety Instructions

Please read and save for future reference.

Some of the following information may not apply to your particular product; however, as with any electronic product, precautions should be observed during handling and use.

- Read these instructions.
- Keep these instructions.
- Heed all warnings.
- Follow all instructions.
- Do not use this apparatus near water.
- Clean only with a dry cloth.
- Do not block any ventilation openings. Install in accordance with the manufacturer's instructions.
- Do not install near any heat sources such as radiators, heat registers, stoves, or other apparatus (including amplifiers) that produce heat.
- Do not defeat the safety purpose of the polarized or grounding-type plug. A polarized plug has two blades with one wider than the other. A grounding type plug has two blades and a third grounding prong. The wide blade or the third prong is provided for your safety. If the provided plug does not fit into your wall outlet, consult an electrician for replacement of the obsolete outlet.

- Protect the power cord from being walked on or pinched particularly at plugs, convenience receptacles, and the point where they exit from the apparatus.
- Only use attachments / accessories specified by the manufacturer.
- Use only with a cart, stand, tripod, bracket, or table specified by the manufacturer, or sold with the apparatus. When a cart is used, use caution when moving the cart / apparatus combination to avoid injury from tip-over.
- Unplug this apparatus during lightning storms or when unused for long periods of time.
- Refer all servicing to qualified service personnel. Servicing is required when the apparatus has been damaged in any way, such as the power cord or plug is damaged, liquid has been spilled or objects have fallen into the apparatus, the apparatus has been exposed to rain or moisture, does not operate normally, or has been dropped.



Important Safety Instructions

Additional safety information

- Apparatus shall not be exposed to dripping or splashing and no objects filled with liquids, such as vases, shall be placed on the apparatus.
- Always leave sufficient space around the product for ventilation. Do not place product in or on a bed, rug, in a bookcase or cabinet that may prevent air flow through vent openings.
- Do not place lighted candles, cigarettes, cigars, etc. on the product.
- Connect power cord only to AC power source as marked on the product.
- Care should be taken so that objects do not fall into the product.
- Do not attempt to disassemble the cabinet. This product does not contain customer serviceable components.

If your product operates on batteries, adhere to the following precautions:

- Any battery may leak electrolyte if mixed with a different battery type, if inserted incorrectly, or if all batteries are not replaced at the same time.
- Any battery may leak electrolyte or explode if disposed of in fire or an attempt is made to charge a battery not intended to be recharged.
- Discard leaky batteries immediately. Leaking batteries can cause skin burns or other personal injury. When discarding batteries, be sure to dispose of them in the proper manner, according to your state/provincial and local regulations.
- Battery shall not be exposed to excessive heat such as sunshine, fire or the like.

Connections and Setup

Accessories provided

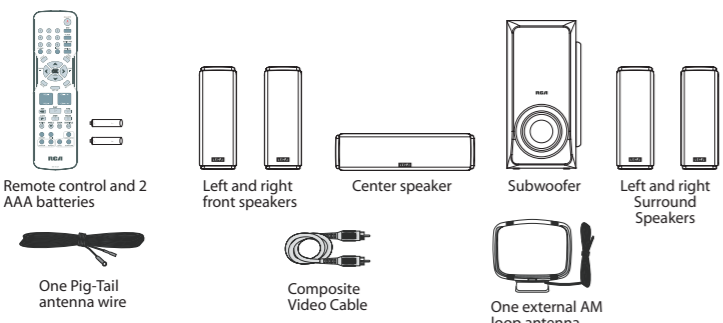

Things to consider before you connect

- Ensure that the mains supply in your house complies with that indicated on the identification sticker located on the back of your unit.
- Install your unit horizontally, away from any source of heat (fireplace) or appliances creating strong magnetic or electric fields. The components of this unit are sensitive to heat. The maximum ambient temperature should not exceed 35°C / 95°F.
- Leave enough space around the unit to allow adequate ventilation: 10 cm/4 inches on either side and above the top, and 5 cm/2 inches at the rear.

- The humidity of the room should not exceed 75%. If you have to use the unit outdoors, do not expose it to rain or splashing water. The apparatus should not be exposed to dripping or splashing and no objects filled with liquids, such as vases, should be placed on the apparatus.
- Moving the unit from a cold place to a warm one can cause condensation on some components inside the unit. Let the condensation disappear on its own before turning the unit on again.
- Before moving the unit, make sure the disc tray is empty.

Connections and Setup

- Where the mains plug or an appliance coupler is used as a disconnect device, the disconnect device shall remain readily operable.
- Other important use and cleaning information at the end of the booklet.

Connecting the antennas

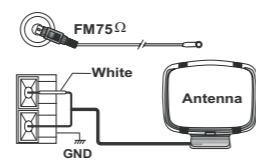

The AM and FM antennas connect to the AM and FM terminals on the system's back panel. They must be hooked up in order to receive clear reception.

AM Loop Antenna

- Uncoil the AM Antenna wire.
- Press down on the Antennas tab to open the terminal.
- Make sure the white wire on the AM loop antenna is inserted into the AM loop terminal and the other wire is inserted into the ground loop terminal.

Connecting to your TV (VIDEO)

- Method 1**
- Composite video jack (yellow)
 - The basic video jack is color-coded yellow.
 - Video cable (yellow) is supplied for the connection for good picture quality.
 - Connect the video OUT jack on the receiver to the Video IN jack on your TV so the video content goes from the receiver to the screen.

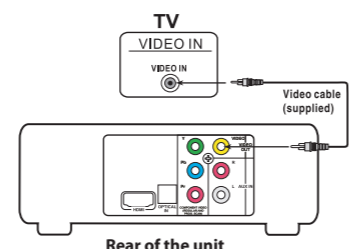

Method 2

- Component video jacks (Pr, Pb, Y)
- The component video jacks are color-coded green, blue and red.
- Additional component video cables (not supplied) are required to provide best picture quality. They are usually color-coded green, blue and red.
- Connect the component video OUT jacks on the receiver to the component video IN jacks on your TV so the video content goes from the receiver to the screen.

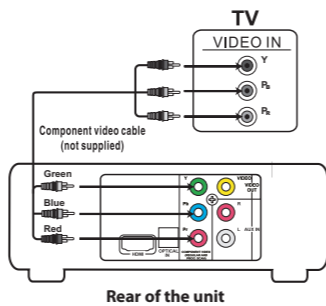

- If your television is a high definition television, use the unit's progressive scan output to get the highest possible video resolution. Set the Progressive Scan option in the Video menu to On.
- If none of the devices is not working, check that all the cables have been inserted properly into the jacks.
- Connecting mono components to your receiver: If your component has only one output for audio (mono), connect it to the white audio jack on the receiver and don't use the cable's red plugs.

Overview of Controls

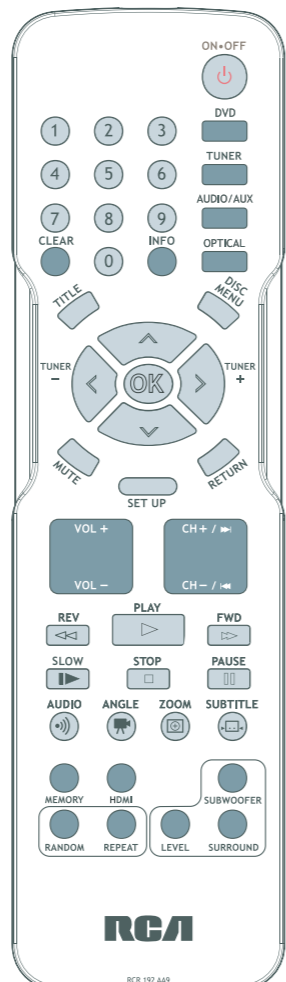

- ON-OFF:** Turns on/off the unit.
- DVD:** Selects the DVD mode.
- TUNER:** Selects the TUNER and selects between FM/AM.
- AUDIO/AUX:** Selects and toggles between the front AUDIO IN mode and rear AUX IN mode. (For listening to audio input from connected TV, VCR or Set Top Box).
- OPTICAL:** Selects OPTICAL IN at rear for digital audio connection.
- 0-9:** Number entry.
- CLEAR:** Quits the current setting manually from the TV screen without saving change.
- INFO:** Accesses the Info menu.
- TITLE:** Accesses the title menu of DVD discs.
- DISC MENU:** Accesses the disc menu during playback.
- OK:** Confirms your selection.
- > / < / ^ / v:** To navigate through the menus. The left and right arrows also tune the radio frequency in the tuner mode.
- MUTE:** Mutes and restores the sound.
- SETUP:** Enters Setup menu.
- RETURN:** In DVD mode, returns to the previous menu. Adjusts the sound volume.
- CH+ / -, CH- / +:** Directly accesses the next or previous chapter (DVD) or track (CD). Selects programmed stations in TUNER mode. Starts reverse accelerated play. Starts playing a disc.
- REV:** Starts forward accelerated play.
- PLAY:** Starts forward accelerated play. Selects SLOW motion function.
- FWD:** Stops playback.
- SLOW:** Freezes frame, accesses frame advance.
- STOP:** Accesses the audio function.
- PAUSE:** Accesses the camera angle function for DVD disc.
- ANGLE:** Accesses the Zoom function.
- ZOOM:** Selects the subtitle languages or turns subtitle off (if available).
- SUBTITLE:** Changes video output signals (480p, 720p, 1080i or 1080p).
- HDMI:** Selects among subwoofer output levels (soft/balance/strong/powerful).
- SUBWOOFER:** Turns on/off random playback on CDDA disc. Accesses the repeat function.
- RANDOM:** Toggles channels for different level settings. Adjusts the value using VOL +/-.
- REPEAT:** Adjusts the value using VOL +/-.
- LEVEL:** Adjusts the value using VOL +/-.

Connections and Setup

Connecting to your TV (via HDMI input)

HDMI stands for High Definition Multimedia Interface. HDMI transfers digital audio and uncompressed digital video on a single cable. Press the HDMI button on the remote control to change output signals as follows: 480p, 720p, 1080i and 1080p.

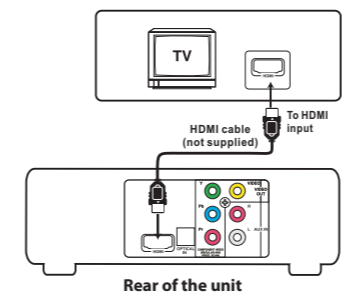

Note: Refer to the owner's manual of the connected TV as well.

Getting sound from external sources such as TV

- Using AUX IN jacks**
- Connect the AUX IN jacks from the unit to the AUDIO OUT jacks on VCR, TV, Set Top Box or other component.
 - Push the AUDIO/AUX button on the remote control to activate the sound from the external source.
 - Push the SURROUND button on the remote control to select the sound mode.

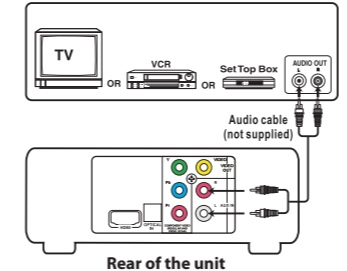

Digital optical input

- Connect components capable of outputting Dolby Digital (e.g. TV or Set Top Box) or standard PCM (CD) format digital signals.
- Push the OPTICAL button on the remote control to activate the sound from the external source.
- Push the SURROUND button on the remote control to select the sound mode.

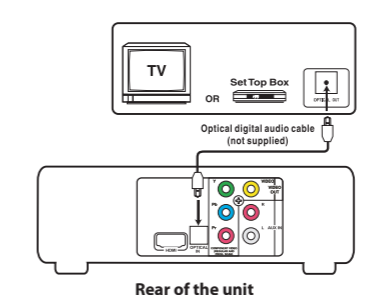

Using AUDIO IN jack

Connect the Ø3.5mm AUDIO IN jack on the front panel of the unit to the headphone output on mp3 players.

- Notes**
- Ø3.5mm to Ø3.5mm audio cables (not included).
 - Press either SOURCE on the main unit or AUDIO /AUX on the remote control to select AUDIO IN mode.
 - Press the SURROUND button on the remote control to select the sound mode.

- Suggest using Ø3.5mm AUDIO IN jack for MP3 player and AUX IN jacks for auxiliary equipment such as DVD, VCR or PC.
- If the AUX IN (or AUDIO IN) audio signal is mono, you may not receive audio on all speakers.

Connections and Setup

Connecting the speakers

Speaker wires are color-coded to match the terminals. Connect the speaker wire from the back of each speaker to the corresponding color terminal at the back of the unit. Press down the tab to open the terminal and insert the wire. Release the tab to lock wire in the terminal.

- When connecting the speakers, make sure the polarities ("+" speaker wire to "+" on the receiver. For example, red wire to red terminal on the receiver) of speaker wires and terminals match. If the cords are reversed, the sound will be distorted. Do not let the speaker wires touch each other.
- Center speaker provided with this unit are magnetically shielded to protect your TV set. It is not recommended to place the front speakers, surround speakers and subwoofer near the TV set.

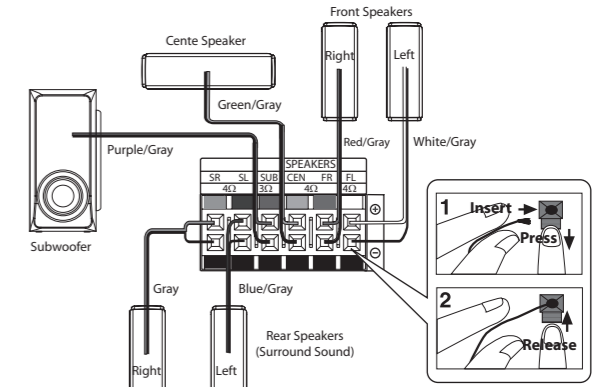

To adjust each speaker volume level for optimum listening experience.

- Press the LEVEL button on the remote control to select FL (front Left speaker).
- Press the VOL+ /VOL- buttons to adjust the value up or down (between -10dB and +10dB).
- Repeat step (1) and (2) for the other speakers FR, SL, SR, CT, SW.

Speaker gains may be set to levels of up to +10dB, actual max levels may also depend on your Volume Setting.

Positioning speakers

- Left, Right (Front Speakers) Front speakers carry primarily music and sound effects.
- Center In surround mode, the center speaker carries most of the dialog as well as music and effects. It should be set between the left and right speakers.
- Surround (Rear Speakers) The surround speakers' overall sound balance should be as close as possible to the front speakers. Proper placement is vital to establish an evenly distributed sound field.
- Subwoofer A subwoofer is designed to reproduce powerful low bass effects (explosions, the rumble of spaceships, etc.).

Playing Discs - Basic Functions

- Compatible discs**
- DVD, DVD-R, DVD-RW, DVD+R, DVD+RW
 - CD, CD-R, CD-RW
- Compatible formats**
- DVD, JPEG
 - CD, VCD

Regional coding

Your unit has been designed to process regional management information stored on DVD discs. The regional code for your unit is 1. Discs that have a different regional code will not play.

Operating the DVD receiver

- Turn on your television set.
- Press ON-OFF on the remote or ON/STANDBY located on the unit's front panel. Press DVD on the remote control.

Loading disc

- Press on the front panel to open the disc tray.
- Place a disc onto the disc tray with the label side up.
- Press again to close the disc tray.

Playback

- Switch the unit and the TV set on.
- After loading a disc, playback starts automatically, or the disc menu appears. If the disc menu appears, select the Play option to begin playback.
 - Press STOP to stop playback.

Accelerated play

While the disc is playing, press REV or FWD one or more times to vary the speed and direction of the accelerated play. Press PLAY to resume normal playback.

Pause

While the disc is playing, press PAUSE once for freeze frame. Press PLAY to resume normal playback.

Frame advance

- Press PAUSE twice. "Step" is displayed.
- Each time you press PAUSE button, the picture advances one frame.
- Press PLAY to resume normal playback.

Basic Playback Operations

- Variable slow motion**
- Press SLOW button on the remote in play mode.
 - Each time the SLOW button is pressed the speed of slow-motion playback changes in the following sequence:



- Press PLAY to resume normal playback.

Changing chapter/track

While the disc is playing, press the CH+/- button to go immediately to the next or previous chapter, or to the next or previous track.

Zoom

- While a disc is playing, press ZOOM until you reach the zoom size you want. The ZOOM button toggles through 2x, 3x, 4x and then zooms out to 1/2x, 1/3x and 1/4x, then returns to normal playback.
- Move from one area to another (pan) using the arrow buttons.
- To turn ZOOM off, press ZOOM until you get to the ZOOM OFF option.

Types of menus

- Disc menu — The appearance and contents of this menu varies according to the type of disc you have inserted. It is separate from the Setup menu.
- Info menu — The unit's Info menu appears at the top of the screen while the disc is playing. Press INFO on the remote to switch the Info menu on or off.

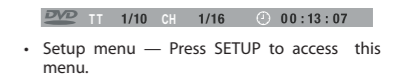

Setup menu — Press SETUP to access this menu.

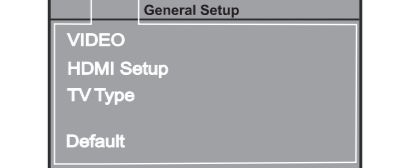

The Info Menu



Notes:

- When you press STOP, the unit stores the point where playback was interrupted. If you press PLAY again, playback resumes from this point. To stop playback completely or to start again from the beginning, press STOP twice. If the unit is left in STOP mode for more than 5 minutes without any user interaction, a screen saver is activated. After the end of 30 minutes without any user interaction, the unit switches off automatically.
- INVALID KEY will be displayed if the function you select is not available.

The Info Menu

- Press INFO on the remote while a disc is playing to display the info menu. The first banner shows title, chapter, and time display information.
- Press INFO again for audio language, subtitles, and camera angle.
- Press INFO a third time for play mode, bookmark and sleep timer.
- Use the right/left arrow buttons on the remote to select an icon.
- Use the up/down buttons to scroll through the options.

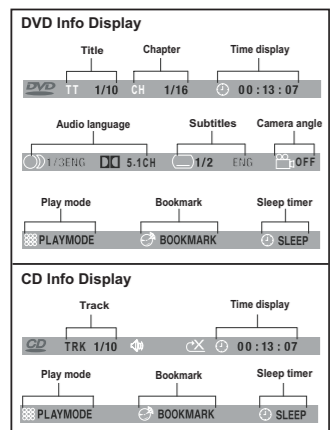

- 12 -

Title/chapter (DVD)/track (audio CD)
To directly access a title, chapter (DVD) or a track (audio CD), press INFO, press OK. Select the Title(TT), Track(TRK) or Chapter(CH) icon and enter a number directly with the numeric buttons. Press OK again to confirm.



Note: Many discs only have one title.

Time display

To access the Time Display, press INFO on the remote. Press the up/down buttons repeatedly to display: DVD: Chapter elapsed time, Chapter remaining time, Title elapsed time and Title remaining time.

Audio CD: Track elapsed time, track remaining time, disc elapsed time, disc remaining time.

To directly access a location on the disc which does not correspond to the start of a title or chapter, press INFO once and press OK, highlight the Time Display icon using the arrow buttons, then enter a time with the number buttons (hh:mm:ss) and press OK.



Note: Time display function may not be available on all discs.

The Info Menu

Audio (DVD)

Some discs have several audio tracks used for different languages or different audio formats.

To change the language or audio format during playback:

- Press the INFO button twice.
- Use the left/right arrow buttons to select the Audio icon, or press the AUDIO button on the remote control.
- Choose a language or an audio format with the up/down arrow buttons.

This option is only available if the disc offers dialog languages or audio formats. When you change the dialog language using the Info menu, it only changes the dialog language of the disc being played. When you eject the disc or switch off the unit, the language will revert to the one you selected in the language Setup menu.

Subtitles (DVD)

Subtitles are turned off by default. Turn on subtitles as follows:

- While the disc is playing, press INFO twice, then select the Subtitles icon using the left/right arrow buttons.
- Select a language using the up/down arrow buttons.
- To turn subtitles off, select the off option or press SUBTITLE on the remote.

When you change the language of the subtitles using the Info menu, it only applies to the disc currently being played. When you eject the disc and switch off the unit, the subtitles will default to the subtitle language you selected in the Languages menu.

This function may not be available on all discs.

Camera angle (DVD)

Some discs offer different camera angles for specific scenes.

- To change the camera angle, press the ANGLE button on the remote or press the INFO button twice and select the Camera angle icon with the left/right buttons.
- Choose the angle with the up/down arrow buttons.

If the disc was recorded using a single camera angle, this function is not available.

Play mode (all discs except jpeg)

- While the disc is playing, press the INFO button twice for CD and three times for DVD.
- Select the Play Mode icon using the left/right arrow buttons.
- Use the up/down arrow buttons to select an option.

- DVD play modes: standard, program, A-B repeat, title repeat, chapter repeat. Program play mode is only available if a program list has been created (see below). Repeat mode is only available with discs that display elapsed time and remaining time. To repeat a sequence between points A and B, choose the A-B repeat option, and then follow the instructions for entering the two points.

- Audio CD play modes: standard, introscan, random, program, repeat A-B, repeat disc, repeat track.

- To stop repeat playback, select the Play Mode icon and use the up/down arrow buttons to choose the Standard option.

The Info Menu

Creating a Program List for Program Play Mode (Audio CDs and DVD discs)
To use program play mode, you must first create a program list.

- To create a program list, press the INFO button twice for CD and three times for DVD. Highlight the Play Mode option and press the up arrow to select the Program option.
- Press OK. The Program screen is displayed.
- The first spot in the list is highlighted. Use the number buttons on the remote to enter a track number. As for DVD discs: T stands for Title while C stands for Chapter. As for Audio CDs: T stands for Track.
- Use the arrow buttons to move to the next spot in the list. Enter the next track number.
- Continue entering tracks until you have completed your list.
- Highlight the Play option at the bottom of the screen and press OK or press PLAY to start playback. The program list will play in the order you programmed it.

To stop program play, press STOP or select Standard from the Play Mode option in the INFO display.

If you want to cancel the list, repeat Steps 1 and 2 to select CLEAR and press OK.

Sleep

- Press INFO twice for CD and three times for DVD. Select Sleep icon with the left/right arrow buttons.
- Select one of the available options using the OK button : Off, 30, 60, 90 or 120 minutes.



Note: This function is not available AUX IN / OPTICAL IN / AUDIO IN / TUNER mode.

Radio

The unit has a built-in tuner that allows for FM radio function. The AM loop antenna allows for AM radio function.

Manual tuning

- Connect the FM antenna and the AM loop antenna at the back of the unit.
- Press TUNER.
- Tune a station by pressing TUNER +/- repeatedly until the desired station is found. Alternatively, you can press and hold the same buttons down for about one second to activate the automatic search function. In this mode the unit will automatically tune frequencies until it finds a station.
- Repeat step 3 to tune to another radio station.
- Press TUNER to toggle between FM and AM.

Storing radio stations

The unit can store up to 30 radio stations in its memory. You can enter every single radio station yourself or the unit can store all available radio stations automatically in ascending order.

Automatic preset programming

- Press TUNER to enter the Tuner mode.
- Press and hold TUNER for two seconds to start automatic preset programming.
- Radio frequencies will be browsed and radio stations stored automatically. When all the available radio stations are stored or all 30 memory locations are full, the auto preset programming function will stop.

Manual preset

- Tune to a radio station (see "Manual tuning" for details).
- Press MEMORY. While the Program Preset number is still flashing, input your desired preset number using the numeric buttons, then press MEMORY to store it.

Retrieving preset stations

- Press TUNER to enter the Tuner mode.
- Press CH +/- to search up or down for the presets stations or directly press the numeric buttons.

Additional Information

Troubleshooting

The unit does not switch on.

- Make sure it is plugged in.
- Press the ON-OFF button on the remote control or the ON/STANDBY button on the front of the unit.

The device switches off spontaneously.

- The device switches off automatically when it is in STOP mode for more than 30 minutes without any user intervention. Switch it on again.
- It might be impossible to read the disc.
- Insert the disc with the printed side facing up.
- Check that the disc can actually be played by this device.
- Check that the disc's regional code matches the unit's regional code. This unit's regional code is 1.
- Clean the disc.

There is no picture.

- Check you have switched on the TV set.
- Check the connections.
- Select the AV input assigned to the unit on the TV.
- Replace the HDMI cable with a better one. Bad HDMI cable can cause data lost.
- Press HDMI key on remote handset several times to toggle among different HD OUTPUT.

The picture is of poor quality (with snow or lines).

- Check the connections.

There is no sound or the sound is of poor quality.

- Check the connections.
- Make sure the speakers are connected.
- Make sure the MUTE function is not on.

No surround sound.

- Surround the speaker configuration in the Setup menu (See Positioning speaker or Audio Setup).
- Do not attempt to look inside the unit through the disk tray opening or any other opening. You may be electrocuted or exposed to laser radiation.



Tips:

- When the FM station broadcasts Stereo sound is found, ST is displayed.
- When you manually tune into a weak FM station, press AUDIO on remote control to switch from Stereo to Mono mode. This will reduce the background noise.
- If there is any interference, change the antenna's position until ideal sound reception is obtained. TV and other electronic devices could be the cause of interference, so try to position the antenna away from them.
- A weak signal can affect the "Automatic preset programming" function's efficiency. Adjust the antenna for better reception and a more efficient search.

AUDIO IN/AUX IN/OPTICAL IN

TV, VCR or Set Top Box can be connected to AUX IN / OPTICAL IN input jacks at the back of the unit or AUDIO IN at the front panel so that sound from the auxiliary component comes into the unit and out through the speakers.

Connecting auxiliary components

Refer to "Getting sound from external sources such as TV" for details on connecting the auxiliary components to the unit.

Selecting AUDIO IN/AUX IN/OPTICAL IN mode

Press either SOURCE on the main unit or AUDIO/OPTICAL on the remote control to select AUDIO IN, AUX IN or OPTICAL IN mode.

Sound output in AUX IN mode (or AUDIO IN/OPTICAL IN mode)

- You may change the surround setting by pressing SURROUND to select between 5.1 CHANNEL and Stereo modes.
- If the AUX IN (or AUDIO IN/OPTICAL IN) audio signal is mono, you may not receive audio on all speakers.

Jpeg Files

Playing jpeg files

Jpeg files are image files. Make sure that they have a resolution of less than 2 megapixels.

- Open the disc tray.
- Place the disc with the printed side facing up and close the disc tray.
- The folders on the disc will be listed in numerical order on the left side of the screen. When you highlight a folder, then press OK button. The list of songs or pictures in the folder are listed in numerical order on the right side of the screen.
- Select a folder using the up/down arrow buttons on the remote, then press the left arrow button to move to the music/picture icons at the bottom of the screen. Use the left/right arrow buttons to select either music or picture mode.
- Press the up arrow button to move to the file list on the right side of the screen. Use the up/down arrow buttons to select a file. Press OK or PLAY to start playback.

- The unit starts the slide show with the jpeg file you have selected, then displays all the jpeg files in the same folder, then all the jpeg files in the subfolders located in the same folder. You can set the amount of time a picture remains on the screen in the General Setup menu.

- During the slide show you can use the left/right button to rotate the picture, the up arrow button to rotate the image vertically, the down arrow button to rotate the image horizontally. Use the ZOOM button to magnify the picture. Use the CH- button to go back to the previous picture or the CH+ button to go to the next one, and the STOP button to interrupt the slide show and display the disc's contents.
- When the unit has played all the files, the music or slide show stops and the disc's contents are displayed again.
- Press STOP to end playback.



Notes:

- The time taken for the contents of the disc to be displayed varies according to the size and number of jpeg files on the disc. If nothing is displayed after a few minutes, the file sizes may be too large. Reduce the files' resolution and write another disc.
- Before inserting a disc, make sure it is compatible with the unit.

- 16 -

Additional Information

- This unit is for domestic use only and must not be used for industrial purposes.
- Total or partial copying of recordings protected by copyright legislation, without the explicit permission of the holder of the rights, contravenes current legislation. Copying or downloading music files for sale or any other business purpose constitutes or could constitute a violation of copyright law.

Cleaning

- Use a soft, dry, clean cloth. Regularly dust the vents at the back or sides.
- Using solvents, abrasive or alcohol-based products risks damaging the unit.
- If an object or liquid enters inside the unit, unplug it immediately and have it checked by an authorized service or service center.

Handling and caring for discs

- Handle your discs with care. Hold the disc with your fingers at the edges or through the hole.
- Insert the disc with the label facing up (for a single-sided disc).
- Place the disc properly into the tray in the allotted holder.
- Use a soft cloth to clean discs if necessary, always wiping from the centre to the edge.
- Always put discs back in their cases after use and store in a vertical position.
- Do not close the tray with two discs in it or with a disc not sitting correctly in the holder.
- Do not play cracked, chipped or warped discs nor try to repair them with adhesive tape or glue.
- Do not write on a disc.
- Do not move the unit when a disc is being played.
- Do not scratch discs or store them in places exposed to direct sunlight, high humidity or high temperatures.
- Do not use aerosol cleaners, benzene, anti-static liquids or any other solvent for cleaning discs. When cleaning, wipe gently with a soft damp (water only) cloth from the centre to the edge, avoiding circular motions, which could cause scratches and interference during playback.

Compatible Formats

In order to ensure playback, discs must conform with DVD or CD standards. This unit may not play some recordings or files due to differences in recording formats, software used and disc types.

DVD-Video

Digital Video discs - 12 cm, single or double sided, single or dual layer. DVDs are high density optical discs on which high quality picture and audio are recorded by means of digital signals.

DVD-R, DVD-RW, DVD+R, DVD+RW

Most DVD-R and DVD+R (one recording only), DVD-RW and DVD+RW discs (rewritable), depending on the DVD writer and discs used. Recordings using DVD-R and DVD-RW discs must be made in Video DVD mode. Recordings using DVD+RW discs must be made in accordance with the specifications for DVD+RW discs with a 4.7 GB capacity.

Audio CDs

Audio CDs (12 cm).

CD-R, CD-RW

Most CD-R (one recording only) and CD-RW discs (rewritable).

CD-Rs written during a multisection recording can be played, provided that the session has ended before the disc is played (depending on the write software). However, depending on the condition of the CD-writer, computer and the disc used, you may find that not all discs will play. When playing a CD-R disc, it is normal for the unit to take up to 60 seconds to recognize the disc before starting to play. If the disc is not recognized after a period of 120 seconds, remove the disc, and insert it again.

- Do not use its full capacity.
- CD-Rs should be preferably used instead of CD-RWs (rewritable CDs) as, in certain cases, CD-RW playback may be faulty.
- Use reliable, good-quality CD write software.
- Close all other applications on the computer to ensure reliable CD-R disc recording.

Additional Information

Jpeg files

CD-R and CD-RW with jpeg files. Certain jpeg files, including progressive jpeg files, cannot be read by this unit.

When composing your title, use 10 characters or less, no spaces, and avoid the use of special characters including (, / ,) , = , + .

The total number of files and folders on the disc should be less than 650.

Make sure that files have the ".jpg" extension. Files without the ".jpg" extension will not be able to be read by the unit — even though the files are shown as jpeg images on your computer.

Sound Enhancement Systems

This receiver is equipped with several built-in sound enhancement systems.

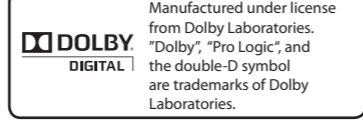

Dolby Pro Logic

The Pro Logic mode uses the built-in circuit to steer the Left, Center, Right and Mono Surround channel audio signals and uses all five speakers to play both stereo and Dolby Pro Logic program source, such as TV and VCR. You can use this mode with any stereo program source (such as VCR/TV) to enjoy multi-channel sound experience.

Dolby Digital

The Dolby Digital mode lets you enjoy full digital surround from software processed in the Dolby Digital format. Dolby Digital provides better sound quality and a more powerful presence than conventional Dolby Surround. This unit is equipped with Dolby Digital 5.1-channel so that you can enjoy enhanced full digital surround sound. The new system provides stereo separation of the rear speakers (Rear-Right, Rear-Left). Adding the subwoofer channel to the 5 channels for bass sounds (counted as 0.1 channel) results in 5.1 channels (or 6 Channels) that bring you the most sophisticated Dolby Digital sound enjoyment.

- 17 -

Technical Specifications:

Amplifier Section:

RMS Output Power: Dolby Digital Mode with 10% Total Harmonic Distortion

Rear Channels: 32 Watts/channel (1kHz, 4Q)
Front and Center Channel: 32 Watts per channel (1kHz, 4Q)

Subwoofer Channel: 40 Watts (100Hz, 3Q)
Total RMS Output Power, Dolby Digital mode: 200 Watts

Muting Attenuation: 70 dB

Frequency Response: 200Hz - 20kHz/3dB, 1kHz ref.

Subwoofer Frequency Response: 20Hz - 200Hz/-3dB, 100Hz ref.

Signal to Noise Ratio: 70 dB (Dolby Digital)

AM Tuner Section:

Frequency Response: 2kHz +/-3dB, 400Hz ref.

Usable Sensitivity: 3000uV/m @ 5/N 20dB

Signal to Noise: 38dB

IF Rejection: 35dB

FM Tuner Section:

Frequency Response: 15kHz +/-3dB, 1kHz ref.

Quieting: 24dB

Signal to Noise: 62dB(stereo) / 65dB(mono)

IF Rejection: 70dB

Dimensions (H x W x D mm) :

Unit: 66 x 430 x 240

Front Speakers: 214 x 78 x 69

Center Speaker: 290.5 x 78 x 69

Rear Speakers: 214 x 78 x 69

Subwoofer: 312.5 x 155 x 273.5

The Setup Menu

Subtitles

Select the subtitle language using up/down arrow buttons and press OK.

To change the language of the subtitles during playback, press INFO twice for DVD and use the left/right arrow buttons to highlight the Subtitle icon. Press the up/down arrow buttons or the SUBTITLE button on the remote to select a subtitle language.

Disc Menu

To change the language of the disc menus, select the language using the up/down arrow buttons and press OK.

The language you select will only be displayed if the disc is programmed with that language.



Notes:

- If the selected language is not available on a disc, the disc's language will be used instead.
- If the language chosen is available, it is automatically selected when you display the subtitles or press SUBTITLE on the remote control. Otherwise, the subtitle language indicated on the disc is selected.

AUDIO SETUP

You can adapt your unit to other equipment and access specific functions with the Audio Setup menu.

- Select the Audio Setup icon in the main menu using the left/right arrow buttons.
- Select an option using the up/down arrow buttons. Press the right arrow to move to the option's choices.

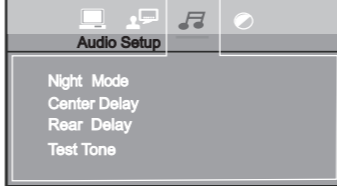

Night Mode

You can use this function to control the different sound levels via dynamic compression. It improves the quality of the sound track at a low volume, and quiets the loudest sounds. You can choose between Quiet, Moderate or Off.

Center Delay / Rear Delay

Basic settings have been preset for the speakers included with your unit. However, to suit the acoustic conditions in your listening room and to make the sound more effective, you may need to delay the signal coming from centre or surround speakers that are closer to the listening position than the front speakers.

- Highlight the Center Delay/Rear Delay option using the up/down arrow buttons.
- Press the right button to move to the default distance.
- Press the up/down buttons to adjust the distance.

Test Tone

This function is used to test and adjust the volume level (gain) for each individual speaker channel.

Use ^ / v to select the speaker channel you wish to test and adjust. You'll hear a test tone come from the speaker you select. Use the VOL button to adjust the level to your desired setting. Press OK button to exit this function.

VIDEO SETUP

- Select the Video icon in the main menu using the left/right arrow buttons.
- Select a menu option using the up/down arrow buttons and press OK.

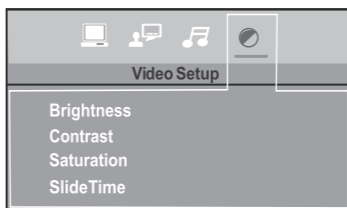

Slide Time

The Slide Time option lets you select the amount of time a picture is displayed in a slide show. The choices are 5 seconds, 10 seconds, or 15 seconds.

- 18 -

Limited Warranty

AVC MULTIMEDIA ("AVC") makes the following limited warranty. These limited warranties extend to the original consumer purchaser and is limited to non-commercial user of the product.

One Year Parts & Labor Warranty

AVC products purchased in the United States are warranted to be free from defects in materials or workmanship for a period of one year from the date of their original retail purchase. If the unit fails to conform to this warranty, we will service the product using new or refurbished parts and products, at AVC's sole discretion.

During a period of one year from the effective warranty date, **AVC** will provide, when needed, service labor to repair a manufacturing defect at its designated Service Center. To obtain warranty service in the United States, you must first call our **Customer Support Center at 1-800-506-5746 or 1-877-252-6873, during the hours listed in the box below.** The determination of service will be made by AVC customer support.

PLEASE DO NOT RETURN YOUR UNIT TO AVC WITHOUT PRIOR AUTHORIZATION. New or remanufactured replacements for defective parts or products will be used for repairs by **AVC** at its designated Service Center for one year from the defective warranty date. Such replacement parts or products are warranted for an additional one year from the date of repair or replacement. The Customer will be required to ship the unit to the Service Center indicated at the time Customer Support is contacted to make the necessary repairs. The customer is responsible for all transportation charges to the service facility.

Packaging and Shipping Instruction

When you send the product to the **AVC** service facility you must use the original carton box and packing material or an equivalent as designated by **AVC**.

Your Responsibility

- You must retain your bill of sale to provide proof of purchase.
- These warranties are effective only if the product is purchased and operated in the U.S.A. or Canada.
- Warranties extend only to defects in material or workmanship, and do not extend to any product or parts which have been lost or discarded, or damage to product or parts caused by misuse, accident, improper operation or maintenance, or use in violation of instructions provided with the product, or to product which has been altered or modified without authorization of **AVC**, or to products or parts thereof which have had the serial number removed or changed.

Out of Warranty

In the event your product requires repair after the limited warranty period has expired, please contact our Customer Support Center at **1-800-506-5746, 1-877-252-6873 or www.RCAav.com**

Hours: Monday-Thursday: 9am-7pm, Friday: 9am-5pm, Saturday: 9am-NOON Eastern time.

Important: You are responsible for any transportation, shipping or insurance relative to the return of the product to our Product Returns Center.

- 22 -

- 20 -

- 21 -

- 15 -

Free Manuals Download Website

<http://myh66.com>

<http://usermanuals.us>

<http://www.somanuals.com>

<http://www.4manuals.cc>

<http://www.manual-lib.com>

<http://www.404manual.com>

<http://www.luxmanual.com>

<http://aubethermostatmanual.com>

Golf course search by state

<http://golfingnear.com>

Email search by domain

<http://emailbydomain.com>

Auto manuals search

<http://auto.somanuals.com>

TV manuals search

<http://tv.somanuals.com>