

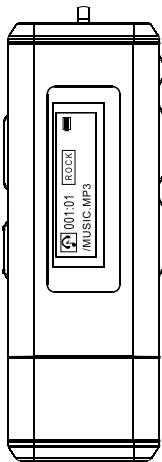

User Manual v 1.0

MP3 Digital Player



B100128/B100512

Thank you for choosing our MP3 Digital Player. Please read through the user manual carefully before operating the machine in order to maximize the ability and life of our product. Please take good care of this manual for future reference. The appearance of our players shown in the manual may differ from the actual products since all pictures are based on the prototype of our models.

As some components would take up space in the flash memory, it is normal to find that the available memory size is less than normal.

CONTENT

<u>Content</u>	1-2
----------------	-----

Overview

Overview	3
LCD Overview	4
Accessory Overview	4
Features	5
Operation notes	5

Operation notes

Battery/turn on or off	8
Two Modes	9
Primary functions	10-12

Advanced functions

Functions overview	14
Music	15
Voice	15-16
Setting	17-20

Connection

Connection	22
Driver installation	23-24
Down load music files	25
Disconnect from PC	26
Formatting	27
Update the player	28
DRM	29-30
General question and answers	31
Menu summary chart	32

If you want to connect this player to the computer, please first connect the USB cable to the player and then to the PC. If you want to disconnect the player from the PC, please first unplug the cable from the PC. Our company will not take the responsibility for damage caused by any inappropriate operation.



- 1. Do NOT replace battery or connect or disconnect with the computer when reading, writing or deleting documents**
 - 2. The digital player will operate at a slower speed when the number of document files created exceeds 50.**
-



Tested To Comply
With FCC Standards
FOR HOME OR OFFICE USE



This digital player complies with the Part 15 of the Provisions of FCC and will be operational under the following circumstances,

- 1). The digital player will not cause any damage to the external environment
- 2). The digital player is vulnerable to distortions caused by improper operations in the external environment
- 3). Under the environment with electrostatic discharge, the MP3 player may malfunction and require user to replay the MP3 player.

Overview

This player is an MP3 player with rewritable flash memory based storage device. It is user-friendly, easy to operate and provides recording ,music playback and many more functions.

Player overview:

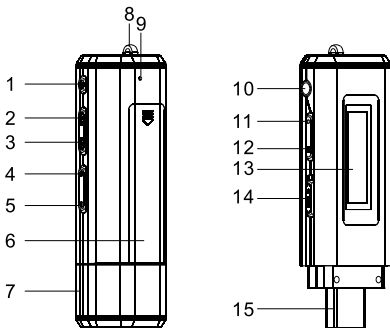

- | | | |
|---------------------------|------------------------|------------------|
| 1. Play/STOP/power supply | 6. Battery cover | 11. A - B/EQ/REC |
| 2. Fast forward/next(FF) | 7. USB socket cover | 12. MENU |
| 3. Rewind(REW) | 8. Neck strap loop | 13. LCD |
| 4. Volume + | 9. Internal microphone | 14. Lock key |
| 5. Volume - | 10. Earphone socket | 15. USB socket |



Note: Press the lock key to  direction to lock the player, or to  direction to unlock it.

LCD

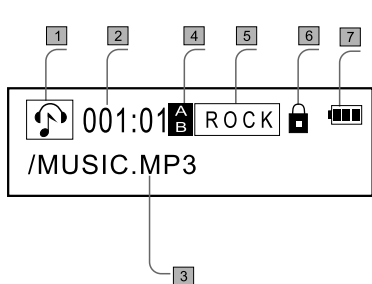

- 1 Function status
- 2 Current file playback time
- 3 Track information
- 4 A-B
- 5 EQ/Playback Mode
- 6 Lock status
- 7 Battery level

Accessories



- 1 1 X installation driver disk



- 2 1 X user manual



- 3 1 X AAA battery



- 4 1 X USB extension cable



- 5 1 X Earphone (with sponge)



- 6 1 X neck strap



- 7 1 X Quick start guide



- 8 1 X Product registration



- 9 1 X call out

Product Features

- Playback MP3/WMA/WAV multi-format files
- 7 Equalizer mode options: Normal, Bass, Rock, Jazz, Class , POP& CUSTOM
- LCD screen display, 7 color backlight with more fashionable effect.
- A-B repeat function
- Long recording time
- 12 Mb full speed USB transfer
- No driver required for windows me/2000/xp (except for Windows 98SE)
- Compact, light weight and stylish design
- Multi-language Version

Operational notes

- The following operating notes are written to enable readers to correctly use the player and keep the player in good operating condition. Please read carefully and comply strictly with the notes.
- The MP3 player should be kept in areas free from extreme temperature changes (above 35 degrees C or below 5 degrees C), moisture and static electricity.
- Please do not hit the player against any hard objects; do not let foreign objects enter the inner parts of the player; do not place heavy objects on the player; do not put the player in close contact with chemicals.
- If the MP3 player will not be operated for a prolonged period, remove the battery to avoid possible damage caused by electrical leakage.
- Please avoid placing the player under direct source of light or heat emitting devices; avoid places with extreme dust and smoke.
- Please do not dismantle, repair or change this player.
- Please keep a copy of the files stored in the player as the company will not be responsible for any loss of such data.
- It is an offence of infringement of other people's intellectual rights to provide WMA or MP3 format musical documents without their prior approval.
- Do not use the player or earphone when driving or cycling.
- For the protection of your ears, please do not listen to the player at high volume for a long period of time.
- Please separate useless packaging materials, batteries and out-dated electronic products when disposing in order to protect the environment.

Data reference

Size (LX WXH)	86 x 38.5 x 18.2 mm(Not include USB cover)
Weight	30g(excluding battery)
Power source	1.5V AAA battery
Encode	ISO 11172-3 (MPEG 1.0 Layer 3), ADPCM
Bit Rate:	64 Kbps-320Kbps
Frequency	8KHz-48KHz
Frequency Range	20Hz-20KHz
Distortion	(1KHz) 0.1%
Signal-Noise Ratio	>80db
MP3 Sound Track Separation	>80db
MP3 Dynamic Range	>93db
Recorder Length	16 bit
Transfer Speed	12 Mb Full Speed USB
Delivery Speed	about 4 Mbps
Power Out	>5mW x 2

Operating instructions

Load battery

Pull out the usb cover, open the battery compartment and load one AAA battery as directed by “+” and “-” markings.



Change battery

When the LCD displays “Low Battery” , You should replace the battery with a new one. pull out the USB cover and open the battery cover,then you can replace the old battery with a new one.

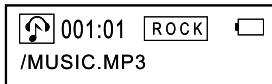

Turning the power on/off

The OSD with backlight appears when ► button is pressed. The user can set the length for the backlight time. Press the ► button for an extended period the player will switch off after a few seconds and will turn off the picture on the screen. When the player is idled for a while, auto power off will activate according to the time set by user. You can also set “disable” function to let the player cancel this function.

The RCA logo, consisting of the letters 'RCA' in a bold, stylized font.The text 'SHUTTING DOWN' in a bold, sans-serif font.

Two functions of this player: Music playing, Voice recording

Shortly press “MENU” to select music playback mode. Then press “MENU” to confirm. Then you can play MP3 and WMA format files under this mode. The machine will automatically switch back to music mode if no operation for more than 10 seconds.

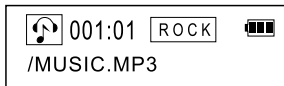

Shortly press “MENU” button to enter music mode. Press “▶▶” button to select voice mode and press “MENU” button again to confirm this mode. It is the same procedure while transferring from “voice mode” to music mode.

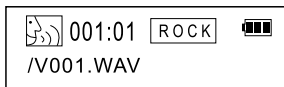

Shortly press “MENU”, press “▶▶” and “◀◀” to loop between MUSIC, VOICE, EQUALIZER, REPEAT, CONTRAST, POWER SAVING, BACKLIGHT, BACKLIGHT COLOR, LANGUAGE, DELETE, ABOUT and EXIT mode. Press “MENU” to confirm and enter into the corresponding choice. (please Ref. Page 14)

When you enter music mode, the player will be in stop status as the following picture shows.

No matter under play, pause, or the stop mode, the icon will alternate as the picture shows.

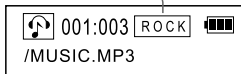

Music playing function: Play/pause/stop

Press ► once to play music.

While the music is playing, the LCD shows the current playing time as the picture shows.

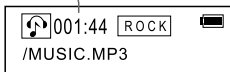

To press the ► again will enter pause state, press the button again to resume play.

LCD will display the pause time at the pause state.

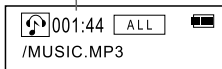

Under play or pause mode, press and hold ► button once to enter the stop mode, slightly press ► to resume play mode.

- 1 The number of the current playing music
- 2 The total numbers of the music stored in the player

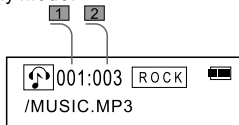

Last song and next song function

Press ►► button to skip to next song, press ◀◀ button to go back to last song.

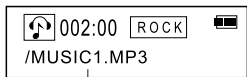
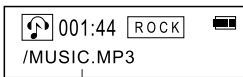

REW/FF Button operation will cause change of song information



Note: skip to the previous file (applicable when the current file has been Played for shorter than 4 seconds)
Reverse to the beginning of the current file (applicable when the Current file has been played for at least 4 seconds)

REW/FF function

Long press on the **▶▶** for FF, resume playing while stopped press. Long press on the **◀◀** for REW function.

The current playing time may change frequently when the REW and FF works.

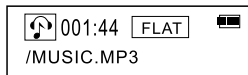

VOL+/VOL-

By pressing VOL+ or VOL- button, you can control the volume under either Play or Pause mode.

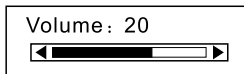

Repeat A-B function

Under music/voice mode, while the player is in play or pause mode, you can press REC button to select A and B, then A-B music or voice will play continuously, particularly convenient for learning foreign languages. Switch between "A" "B" and Cancel setting by pressing repeatedly this button.

Repeat A-B setting display

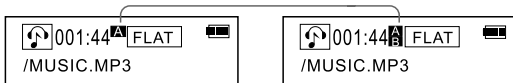

Equalizer mode



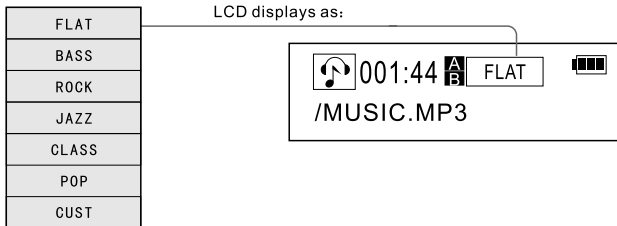







Under music or voice mode, long press REC button to do cyclical selection of the equalizer modes. The digital player has the below EQ setting (for another set method please refer to P.17)



Note: Under the stop mode the A-B repeat function is out of work, long press REC button for EQ setting, lightly press for A-B repeat function.

Advanced functions

After you are familiar with basic operation of this Mp3 player, we will describe more particular and advanced functional settings of the player to help you become an advanced user. It mainly includes the menu system contained in the “Setting” menu.

 MUSIC
 VOICE
 EQUALIZER
 REPEAT
 POWER SAVING
 BACKLIGHT
 BACKLIGHT COLOR
 LANGUAGE
 DELETE
 ABOUT
 EXIT

Press “MENU” and then press “▶▶” or “◀◀” button to do cyclical selection of the choices. LCD display as.



Menu function

Shortly press Menu button to enter the above functions. Press “▶▶” or “◀◀” to do cyclical selecting of the above 12 functions and press “MENU” to confirm your choice.



Note: Apart from the recording mode that denies access to menu options, you can make your Setting in play, pause or stop mode. The digital player will return to play mode (the last setting mode), automatically if idle for 10 seconds in this selection.

Music mode

This is the default mode of the digital player. You can play MP3 or WMA music files under this mode. You can also operate the songs with functions of REW、FF、Volume Adjustment, Sound Effect Setting, Repeat and Sequence (Refer to page 10-12).

Voice mode

Under the music mode, press “MENU” button and “▶▶” button to select voice mode then press “MENU” button to confirm. Under voice mode, you can select play/record/repeat/A-B/REW/FF/VOL+,VOL-/EQ setting.

1.Play/REW/FF/VOL+,VOL-(Ref. P. 10-11)

2.Recording

Under voice mode, LCD displays as:

- 1 Recorded file information
- 2 Voice status mode
- 3 Current voice file number
- 4 Number of stored voice files

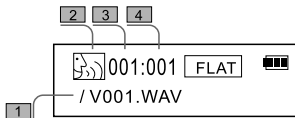

Note: The recorded file only can be in WAV format instead of MP3 format.

Start recording

In voice mode under the stop state, press “REC” button to start recording, the LCD display is as follows

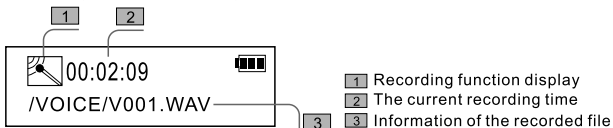

Stop recording

Press “REC” button again to stop recording, LCD displays as the previous page shows.

Playback recorded file

The operation procedure is the same as music playback (Ref. P. 10-11).

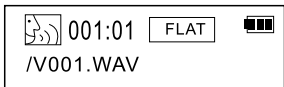

Name the recorded file

For the large quantity of recorded files, it is suggested that you rename each file with an easily recognized name.



Note: A-B Segment repeat function only works under the play/pause mode and it can't work under recording or stop mode. Press “REC” for a while and then users can adjust the EQ mode in play/pause/stop status. Users can't use this function in recording mode.

The EQ setting

Press “MENU” button to enter the menu interface, press “▶▶” “◀◀” for the EQ setting, press “MENU” button to confirm. All together 7 modes for this setting (for another method please Ref. P.12)

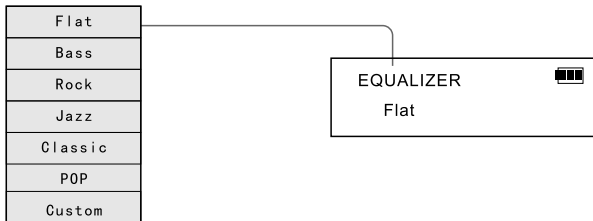

When you choose the equalizer mode, you can press “▶▶” and “◀◀” to enter the CUSTOM mode to customize your own equalizer settings. First of all, press the “Menu” button to confirm. Then, you may press “▶▶” or “◀◀” to choose on different frequency range. Finally, press “VOL+” and “VOL-” to increase or to decrease each frequency range by your own preference.

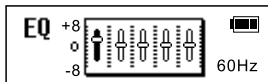

Repeat mode

Press “MENU” button to enter the interface as the following picture shows, press “▶▶” “◀◀” for the repeat mode and press “MENU” button to confirm. Long press on “MENU” button to cycle the play mode, altogether 5 playing modes are included.

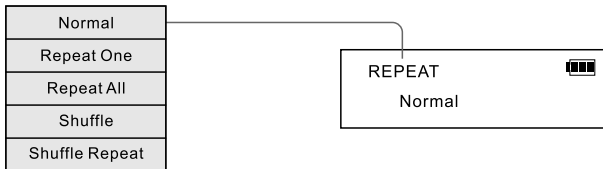

Repeat Mode and Sound Effect LCD Display

The digital player will display repeat mode and sound effect in 3-second intervals alternately at the same position.

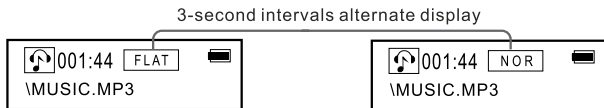

Power Saving

This function consists of five different idle time settings while the digital player is in music mode or voice mode. The digital player will be switched off automatically after the idle period for saving battery. The digital player can also be set to forbid automatic switch-off. Press the “MENU” button to enter the menu screen, then press “▶▶” or “◀◀” to select power saving setting. Press the “MENU” button to confirm your selection.

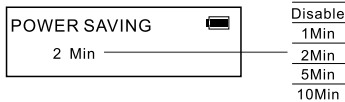

Backlight

This consists of three settings of backlight: When you operate the digital player in idle status, the backlight will turn on automatically for convenience of use at night. You can set the time of backlight is on, or you can choose to have the backlight always off or always on. Press the “MENU” button to enter the menu screen, then press “▶▶” or “◀◀” to select backlight setting. Press the “MENU” button to confirm your selection.

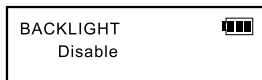

Backlight color

This item includes 7 types of backlight color. You can select your favorite color and the corresponding color will display when you operating the player. Press the “MENU” button to enter the menu screen, the press “▶▶” or “◀◀” to select backlight setting. Press the “MENU” button to confirm your selection.

BACKLIGHT COLOR 
Green

Language

There are various types of languages to choose. Press the “MENU” button to enter the menu screen, then press “▶▶ or ◀◀ ” to select language setting. Press the “MENU” button to confirm your selection.

LANGUAGE 
ENGLISH

Erase files

Press the “MENU” button to enter the menu screen, then press “▶▶ or ◀◀ ” to select deletion setting. Press the “MENU” button to confirm your selection.

DELETE 
Voice File

Music File
Voice File
Exit

Delete file

Following the step of the previous page enter into the delete mode, choose the file you want to delete, press “MENU” enter the relevant choice, press “VOL +, VOL -” to cycle selecting “Yes/No” and then the “MENU” button to confirm. Press ▶▶ or ◀◀ to choose the corresponding file with it's name display (the file you will delete should be in the WAV format).

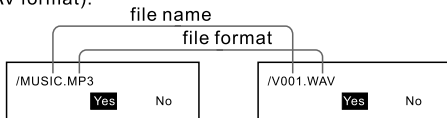

When the file is deleted, it displays as below and return to the status as the above picture shows, press ► to exit and back to the delete mode.

Delete Successful

System information

Press “MENU” button to enter the menu interface, press “▶▶ or ◀◀” button to choose about, press “MENU” button to confirm and then the information about this player may display as below.

VERSION: :x.xxx
MEMORY: :xx/xxxMB

EXIT

Press “MENU” to enter the menu interface, press “▶▶ or ◀◀” button to choose backward then “MENU” to confirm and backward to the music/voice mode (the latest setting mode)



Note: As some components would take up space in the flash memory, it is normal to find out that the available memory size is less than normal.



Note: Under this mode, 10 seconds standby time can cause the machine to return to music playing/voice mode (the latest setting one)

CONNECTION WITH COMPUTER

Requirement for computer system

1. Operating system: Microsoft Windows 98 SE, Windows Me, Windows 2000, Windows XP
2. CPU: Intel Pentium3, Pentium 4 and other CPU with the relevant functions.
3. Memory: above 64 MB
4. HD: 200MB idle memory and above
5. Interface: full-speed USB
6. CD-ROM

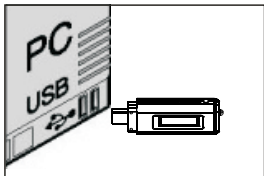

Connect with computer

Connect the player to the computer with the USB cable provided.

Installation of the communication software

No additional driver software is required for Windows 2000/Me/XP & Macintosh after connecting the player to the computer via USB. It will be recognized automatically as a “Removable drive” for Windows 98 SE, please install the driver software from CD-ROM provided.

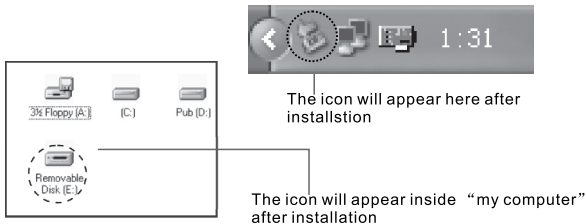

Windows 98 SE CD-ROM installation

Put bundled CD-ROM into computer, and follow the instruction to finish the installation.

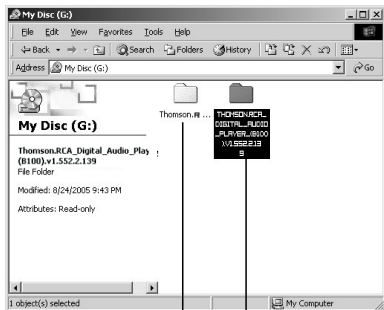

WINDOWS 98 SE
Installation driver and
software updater

WINDOWS2000/XP/98 SE
Installation driver and
software updater

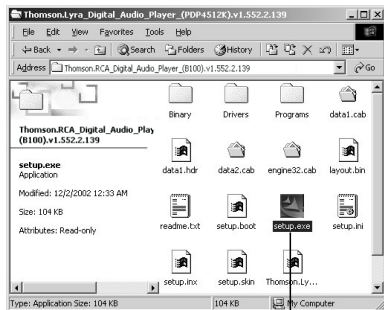

Double click SETUP . EXE to
start installation

1

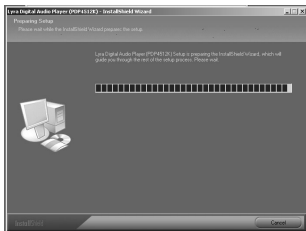

2



3

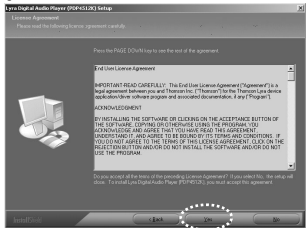

4

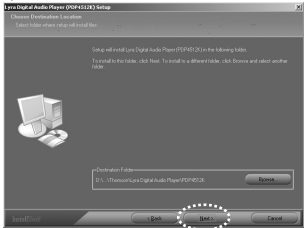

5

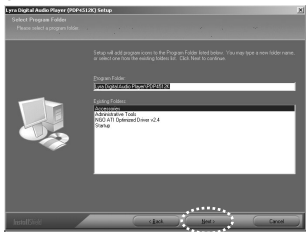

6

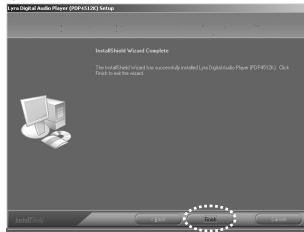

Save and rename downloaded music and voice files

After successfully connecting the player to the computer, it will appear as a “Removable disk” Double click this disk, it will show as following:

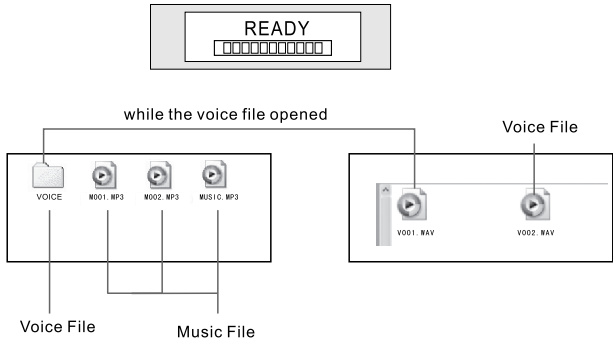

Note: While the file is deleted, it may disappear until the new recording start.



Note: This player can recognize and play the music file in MP3 and .WMA format, the voice file in .WAV format.

The operating procedure of the removable flash disk is the same as normal USB storage device. Users may copy files to relevant folder. You may also rename it for your own convenience.



this icon may display after proper connected with the computer

Disconnection with computer

The switch on/off buttons will not function when the digital player is linked up with the computer. To disconnect with the computer, please operate as follows, hit the right button and the “Safe Delete Hard Disk” will appear with a dialogue box. Confirm and disconnect accordingly.

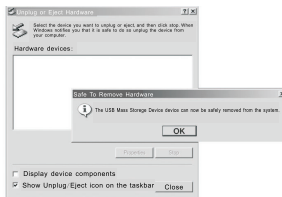

Note: DO NOT unplug the player from the computer's USB port until Windows prompt that it is safe to do so. Otherwise data loss or even physical damage to the player may occur. Our company will not be responsible for any damage/loss caused by inappropriate operation .

Formatting

Apart from the above-mentioned operations, the digital player can also be formatted. Hit the right button on the keyboard and a window will appear. **Make sure the format chosen for formatting must be “FAT”** . If others formats like “FAT32” or “NTFS” are chosen, the digital player will lose the function of playing music and can only perform as a mobile hard disk. To restore the functionality of the digital music player, choose “FAT” format again for re-formatting.

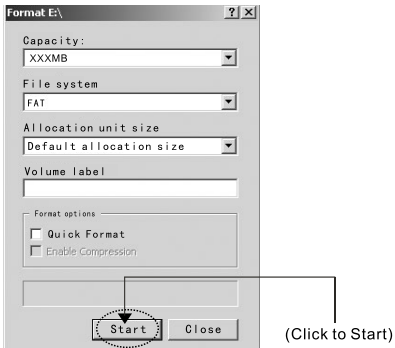

Note: Please do not format the player frequently, it may cause the damage and influence the life of the player.



Note: please format the player if you encounter the following situations

1. the problems can't be solved after referring to the General questions & answers
2. The player can't delete / read / record the file or the files have been damaged.

Update the player

Use the installation driver on computer to update and maintain firmware

1. Connect the player with computer, and run "Update device" on PC port

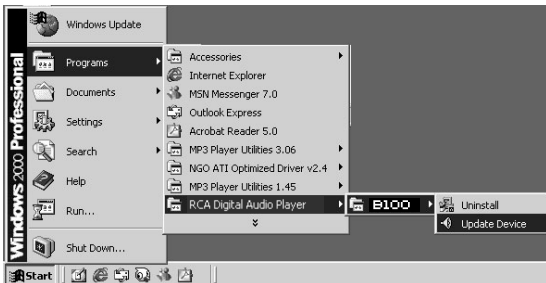

2. Then click "Start" button to start installation

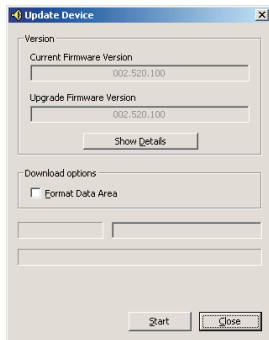

3. Click "Close" to exit after finishing installation

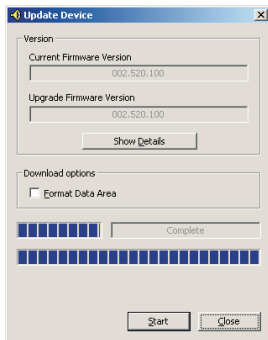

Digital Rights Management of Documents

There is a copyright protection measure for WMA formatted songs to protect songs from being illegally copied without obtaining the necessary authorization from the owner. As such, users should not download songs without proper authorization and play with this digital player. Users should pay attention to the format of the musical document and the type of player to play the musical document. There are different means of obtaining proper authorization and payment details for different players and hence users should go to the website of the particular player for details of the above. Users need to carry out the following instructions to obtain the necessary authorization and then proceed to download and save in the player if they want to play songs without the proper authorization. (This process is based on the example of the authorization process of Version 9 of the Windows Media Player).

1. Ascertain if the computer has installed the software Windows Media Player. A copy of the software can be downloaded from the Microsoft website <http://www.microsoft.com/windows/windowsmedia>. (The Windows Media Player software is provided free by Microsoft Corporation for playing WMA formatted songs).
2. Start the “document” in the Windows Media Player menu and “open” a WMA formatted song with no proper authorization. If the user has not obtained the individual permit to play, the digital player will automatically link up with the Microsoft Corporation website (as shown in Diagram 1) and after the user successfully obtains the approval (as shown in Diagram 2), the WMA formatted song can be opened.

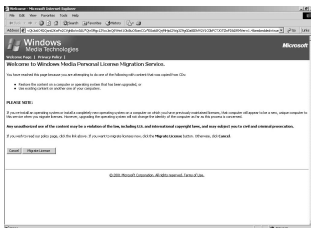

(Picture 1)

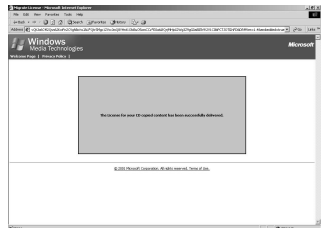

(Picture 2)

General questions & answers

Problems	Possible causes	Suggested solutions
<ul style="list-style-type: none"> Unable to switch on the player 	<ul style="list-style-type: none"> Check if battery is exhausted Check if battery is correctly loaded 	<ul style="list-style-type: none"> Change new batteries Reload batteries again according to “+” and “-” signs correctly
<ul style="list-style-type: none"> No sound from the earphone 	<ul style="list-style-type: none"> Loosen plug Volume is “0” Check the battery status Check the plug for whether it has been oxidized or covered by any dirty stain Damage to the MP3 or WAV files 	<ul style="list-style-type: none"> Re-plug the earphone Increase the volume Change the battery Clean the plug Re-download related files
<ul style="list-style-type: none"> No display on the LCD screen 	<ul style="list-style-type: none"> Wrong language setting Not support the certain language 	<ul style="list-style-type: none"> Set the correct language Brows our website for latest version
<ul style="list-style-type: none"> Can't upload/download MP3/WMA/WAV files 	<ul style="list-style-type: none"> Check the battery status Check the connection to PC Out of memory 	<ul style="list-style-type: none"> Change the battery Reconnect the USB cable Delete files to release more memory
<ul style="list-style-type: none"> Cannot record voice 	<ul style="list-style-type: none"> No more space in memory 	<ul style="list-style-type: none"> Delete some files in order to release more storage space



MENU
Press “▶▶” “◀◀” button to select

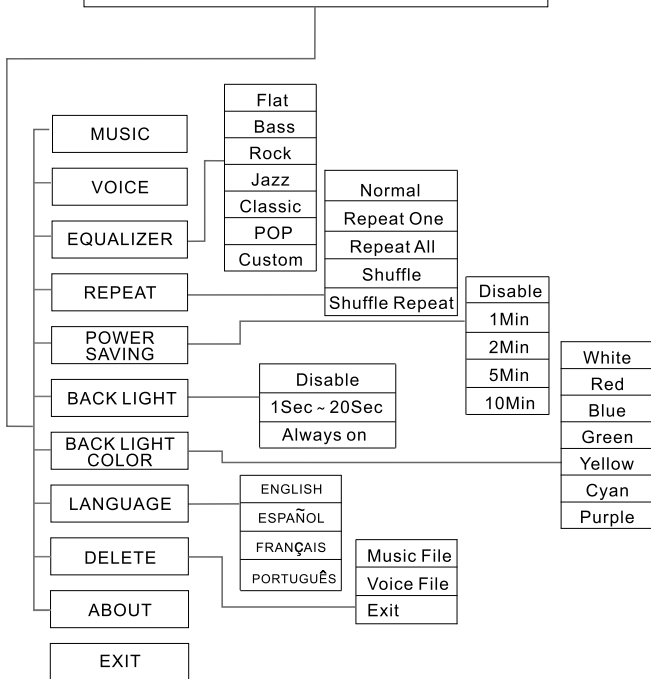

Free Manuals Download Website

<http://myh66.com>

<http://usermanuals.us>

<http://www.somanuals.com>

<http://www.4manuals.cc>

<http://www.manual-lib.com>

<http://www.404manual.com>

<http://www.luxmanual.com>

<http://aubethermostatmanual.com>

Golf course search by state

<http://golfingnear.com>

Email search by domain

<http://emailbydomain.com>

Auto manuals search

<http://auto.somanuals.com>

TV manuals search

<http://tv.somanuals.com>