



digital video disc player
the ultimate movie experience!



RCA
user's manual
RC5231Z



CAUTION

RISK OF ELECTRIC SHOCK
DO NOT OPEN

TO REDUCE THE RISK OF ELECTRIC SHOCK, DO NOT REMOVE THE COVER (OR BACK). NO USER-SERVICEABLE PARTS ARE INSIDE. REFER SERVICING TO QUALIFIED SERVICE PERSONNEL.



This symbol indicates "dangerous voltage" inside the product that presents a risk of electric shock or personal injury.



This symbol indicates important instructions accompanying the product.

CAUTION: DVD PLAYERS USE A VISIBLE LASER BEAM WHICH COULD CAUSE HAZARDOUS RADIATION EXPOSURE IF DIRECTED. BE SURE TO OPERATE THE PLAYER CORRECTLY AS INSTRUCTED.

CAUTIONS

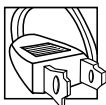

Caution: To prevent electric shock, match wide blade of plug to wide slot, fully insert.

Attention: Pour éviter les chocs électriques, introduire la lame la plus large de la fiche dans la borne correspondante de la prise et pousser jusqu'au fond.

This product satisfies FCC regulations when shielded cables and connectors are used to connect the unit to other equipment. To prevent electromagnetic interference with electric appliances, such as radios and televisions, use shielded cables and connectors for connections.

FCC NOTE (for U.S.A.):

This equipment has been tested and found to comply with the limits for a Class B digital device, pursuant to Part 15 of the FCC rules. These limits are designed to provide reasonable protection against harmful interference in a residential installation. This equipment generates, uses and can radiate radio frequency energy and, if not installed and used in accordance with the instructions, may cause harmful interference to radio communications. However, there is no guarantee that interference will not occur in a particular installation. If this equipment does cause harmful interference to radio or television reception, which can be determined by turning the equipment of and on, the user is encouraged to try to correct the interference by one or more of the following measures.

- Reorient or relocate the receiving antenna.
- Increase the separation between the equipment and receiver.
- Connect this equipment into an outlet on a circuit different from that to which the receiver is connected.
- Consult the dealer or an experienced radio/TV technician for help.

This class B digital apparatus meets all requirements of the Canadian Interference-Causing Equipment Regulations.

Product Registration

Please fill out the product registration card and return it immediately. Returning this card allows us to contact you if needed.

Keep your sales receipt to obtain warranty parts and service and for proof of purchase. Attach it here and record the serial and model numbers in case you need them. The numbers are located on the back of the player.

Model No. **RC5231Z**

Serial No. _____

Purchase Date: _____

Dealer/Address/Phone: _____

WARNING

To reduce the risk of fire or shock hazard, do not expose this DVD player to rain or moisture.

CAUTION

THIS PRODUCT UTILIZES A LASER. USE OF CONTROLS OR ADJUSTMENTS OR PERFORMANCE OF PROCEDURES OTHER THAN THOSE SPECIFIED HEREIN MAY RESULT IN HAZARDOUS RADIATION EXPOSURE. DO NOT OPEN COVERS AND DO NOT REPAIR YOURSELF. REFER SERVICING TO QUALIFIED PERSONNEL.

CAUTION

FCC Regulations state that unauthorized changes or modifications to this equipment may void the user's authority to operate it. To assure compliance with FCC requirements, you must use the telephone line cord that is packed with this product. It is equipped with a special filter.

Note:

This unit can be used only where the power supply is AC 120 V, 50-60Hz. It cannot be used elsewhere.

Note:

This DVD player is designed and manufactured to respond to the Region Management Information. If the Region number of a DVD disc does not correspond to the Region number of this DVD player, this DVD player cannot play the disc. The Region number for this DVD player is Region No 1.

Note:

This device is protected by U.S. patent numbers 4,631,603 and 4,577,216 and 4,819,098 and other intellectual property rights. The use of Macrovision's copy protection technology in the device must be authorized by Macrovision and is intended for home and other limited pay-per-view uses only, unless otherwise authorized in writing by Macrovision. Reverse engineering or disassembly is prohibited.

**CLASS 1
LASER
PRODUCT**

Table of Contents

Setup & Connections	3	Changing the Camera Angle	29
Unpack the Box	4	Using Bookmarks	29
Install Batteries in the Remote	4	All About Divx	31
Important Battery Information	4	How to Play Divx Discs	32
Types of Discs the Player Can Play	5	View Movie Settings	33
Consider the Location of Your Player	5	View Movie Status	34
Protect Components from Power Surges	5	DivxSilver (Purchase Unlimited Play)	34
Position Cables Correctly	5	Selecting a Chapter on a Divx Disc	35
The Jacks on the Back of the DVD Player	6	All About Divx Mail	36
Connection Options:		How to View a Divx Mail Message	36
DVD Player + TV with Audio/Video Input Jacks	7	How to Erase A Mail Message	37
DVD Player + TV without Audio/Video Input Jacks (Antenna Jack Only)	8	How to "Unerase" a Mail Message	37
DVD Player + TV + VCR	9	Viewing a Specials Message	38
DVD Player + TV + Dolby Pro Logic or Dolby Digital or DTS Receiver	10	Viewing Your Divx Statement	39
Set the Menu Language	12	How to Set a Dialing Prefix	40
How to Move Around the Player's Menu System	12	How to Erase a Dialing Prefix	40
Register with Divx	13	How to Get Help (Customer Service)	41
How to Find Your TV's Video Input Channel	14	How to Set Divx Limits	42
Tour of the Remote Control	15	To Set Rating Limits	42
Component Buttons	15	To Restrict Rentals	43
Other Remote Control Buttons	16	To Restrict Purchases	43
Helpful Hints about the Remote	18	Important Account Information	44
Pick the Right Mode	18	Using the Features in the Menu System	45
Point the Remote in the Right Direction	18	How to use your Remote to Move through the Player's Menu System	46
The Buttons Might Operate Differently	18	The Play Menu Options	48
Playing Digital Video Discs	19	How to Create a Program:	48
Loading and Playing a Disc	20	How to Delete or Edit a Program:	49
Using a Disc Menu	21	Disc Guide	49
Disc Playback Features	22	How to Use the Lock Menu	50
Fast Motion Playback (Picture Scan)	22	To Lock your DVD Player:	50
Freeze Frame and Frame Advance	22	To Unlock the Player:	51
Slow Motion Playback (in Freeze Frame Mode)	22	How to Change Your Password	51
Chapter Advance	22	How to Set Divx Limits	52
Using the On-Screen Info Display	23	Setting the Rating Limit	52
Selecting a Title	23	How to Set DVD Limits	52
Selecting a Chapter	24	Using the Setup Menu	54
Selecting Different Play Modes	25	Language Prefs (preferences)	54
Using the Repeat Feature	25	Changing the Audio Language Preference	55
Changing the Subtitle Language	27	Changing the Subtitle Language Preference	56
Changing the Audio Language	28	AutoPlay	57

Dolby Digital is a trademark of Dolby Laboratories Licensing Corporation

DTS is a trademark of Digital Home Theater Systems, Inc.

Table of Contents

Changing the Menu Language.....	57	Reference	81
Display	58	Front Panel Controls.....	82
Sound.....	59	Front Panel Display	83
Audio Equipment	60	Programming the Remote	84
The System Test	60	Using Automatic Code Search	84
Glossary	61	Using Direct Entry	85
Divx	61	TV Codes	86
Playing CDs	63	Cable Box Codes.....	86
Loading and Playing an Audio CD	64	VCR Codes.....	87
Audio CD Playback Features	65	Satellite Receiver Codes	87
Using the Info Display	65	FCC Registration Information.....	88
Selecting a Specific Track	66	Industry Canada Information	88
Selecting a Play Mode	66	Accessories and Order Form	89
Repeat Play.....	68		
Using IntroScan	70		
Using Bookmarks.....	70		
Using the Clock.....	71		
The Play Menu Items	72		
Dub Assist.....	72		
Assistance	73		
How to Resolve Product Performance Problems	74		
Troubleshooting.....	74		
Troubleshooting.....	75		
Troubleshooting.....	76		
Troubleshooting.....	77		
Handling Cautions	78		
Maintenance of Cabinet	78		
Formation of Condensation	78		
Handling Discs.....	78		
Cleaning Discs	78		
How to Resolve Product Performance Problems	79		
Limited Warranty.....	79		

Setup & Connections

Please Read This Section First

This section includes key information to get you started in the right direction. You'll get your DVD Player set up and connected. The rest of this User's Guide discusses the player's features and how to use them.

Section Overview:

- Unpack the Box
- Types of Discs You Can Play
- The Jacks on the Back of Your DVD Player
- Connecting Your DVD Player
 - TV with Audio/Video Input Jacks
 - TV *without* Audio/Video Input Jacks (Antenna Jack only)
 - How to Connect a VCR
 - DVD Player + TV + Dolby Pro Logic or Dolby Digital or DTS Receiver
- A Tour of the Remote Control
- Connect to Divx (Digital Video Express)

*Dolby Digital is a trademark of Dolby Laboratories Licensing Corporation
DTS is a registered trademark of Digital Theater Systems*

A Note about the Illustrations

The illustrations in this book are representational, and in some instances may not exactly match the item represented.

Setup and Connections

Unpack the Box

Carefully unpack the items in the box:

- DVD player
- Remote control and batteries
- Audio/Video cables
- S-Video cable
- Power cord
- Telephone line cord
- Telephone jack splitter (2-in-1 Modular Adapter)

Install Batteries in the Remote

1. Open the battery door on the back of the remote.
2. Insert fresh batteries. Make sure that the polarities (+ and -) are aligned correctly.
3. Replace the battery door.

Important Battery Information

- If you're not going to use the remote for a month or more, be sure to remove the batteries because they can leak and cause damage.
- Dispose of batteries in the proper manner, according to federal, state, and local regulations.
- Any battery may leak electrolyte if mixed with a different battery type, if inserted incorrectly, if all batteries are not replaced at the same time, if disposed of in fire, or if an attempt is made to charge a battery not intended to be recharged.
- Discard leaky batteries immediately. Leaking batteries can cause skin burns or other personal injury.



The Telephone Jack Splitter Makes it Easy to Keep Your DVD Player Connected without Interrupting Routine Phone Use

You must connect the telephone line cord to your DVD Player and to a telephone jack in order to use all of the Divx features.

We've provided a telephone jack splitter so you can keep your DVD Player and your phone connected to the phone jack all the time.

Insert the splitter into the phone jack. Insert the telephone line cord from your phone into one of the splitter's jacks and insert the telephone line cord from your DVD Player into the other jack on the splitter.

Types of Discs the Player Can Play

This DVD Player is capable of playing the following types of discs with the corresponding logos.



Divx discs



DVDs



Audio CDs

DO NOT Use CD-R Discs!

The wavelength of the pickup of this DVD Player may cause CD-R discs to be erased. **DO NOT** play CD-R discs in this player!

Consider the Location of Your Player

You must connect your DVD Player to a telephone jack in order to play Divx discs. The telephone line cord packed with your player is approximately 25 feet long. Consider this when deciding where to hook up your DVD Player.

Protect Components from Power Surges

- Connect all components before plugging any power cords into the wall outlet.
- Always turn off the DVD Player, TV, and other components before you connect or disconnect any cables.

Position Cables Correctly to Avoid Audio Hum or Interference

- Insert all cable plugs firmly into their jacks.
- Place the audio/video cables to the sides of the TV's back panel instead of straight down the middle after you connect your components.
- Try not to coil any twin-lead cables and keep them away from the audio/video cables as much as possible.
- Make sure all antennas and cables are properly grounded.

CAUTION

Protect your components from overheating.

- Do not stack electronic components or other objects on top of the DVD Player.
- Do not block ventilation holes in any of the components. Arrange the components so that air can circulate freely.
- Allow adequate ventilation when placing your components in a stand.

See Safety Information on the inside front cover.

Setup and Connections

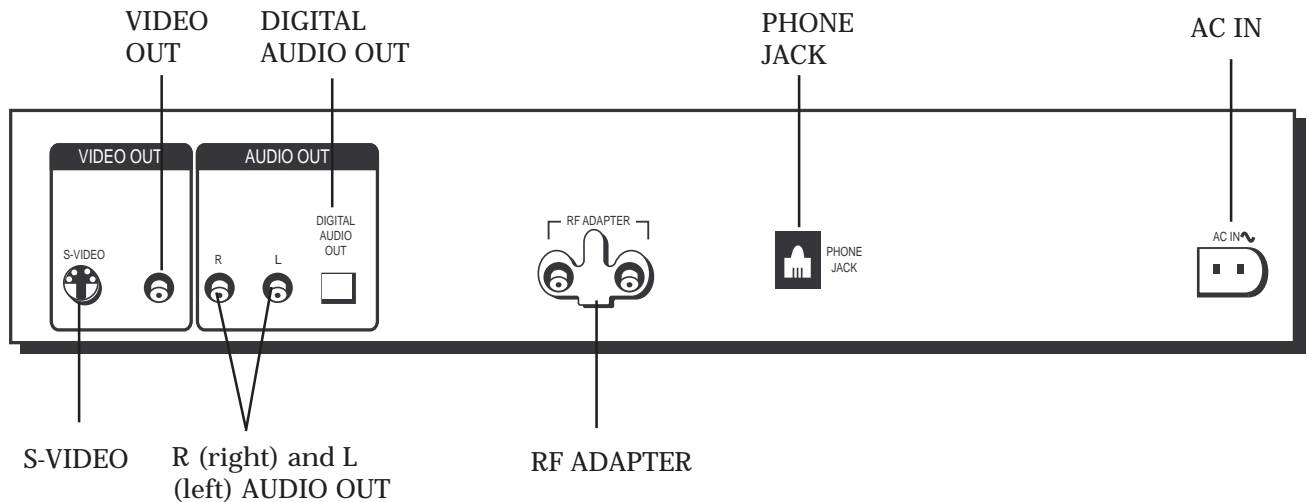

The Jacks on the Back of the DVD Player (listed alphabetically)

AC IN – Insert the AC power cord into the DVD Player and plug the other end into an AC outlet.

AUDIO OUT R and L – Insert audio cables (left and right) to these jacks on your DVD Player and to the corresponding Audio Input jacks (left and right) on your TV or receiver.

DIGITAL AUDIO OUT – Use a digital optical cable (not provided) to connect your DVD Player to a compatible Dolby Digital receiver or decoder. Dolby Digital offers theater-quality sound (six channels).

PHONE JACK – Insert one end of the telephone line cord into this jack and insert the other end into one of the jacks on the telephone jack splitter. Insert the telephone jack splitter into a telephone jack. You must connect the telephone line cord in order to use Divx features.

RF ADAPTER – Use coaxial cables to insert an RF Adapter (not provided) into this jack and to the Antenna Input Jack on your TV. An RF Adapter is needed if your TV doesn't have Audio/Video Input jacks. See p. 8 for connection instructions.

S-VIDEO – If your TV has an S-Video jack, you can connect an S-Video cable to your TV and to your DVD Player for increased video quality. The S-Video cable only carries the picture signal; remember to connect the left and right audio cables.

VIDEO OUT - Connect a video cable to this jack and to the Video Input jack on your TV.

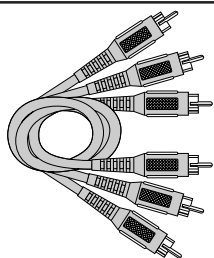

Important Information About the Pictures used in the Connections

The Audio/Video cables that came with your DVD Player are bundled together. For better visibility, we've shown each cable (audio left, audio right, and video) separately in the connections pictures that follow.

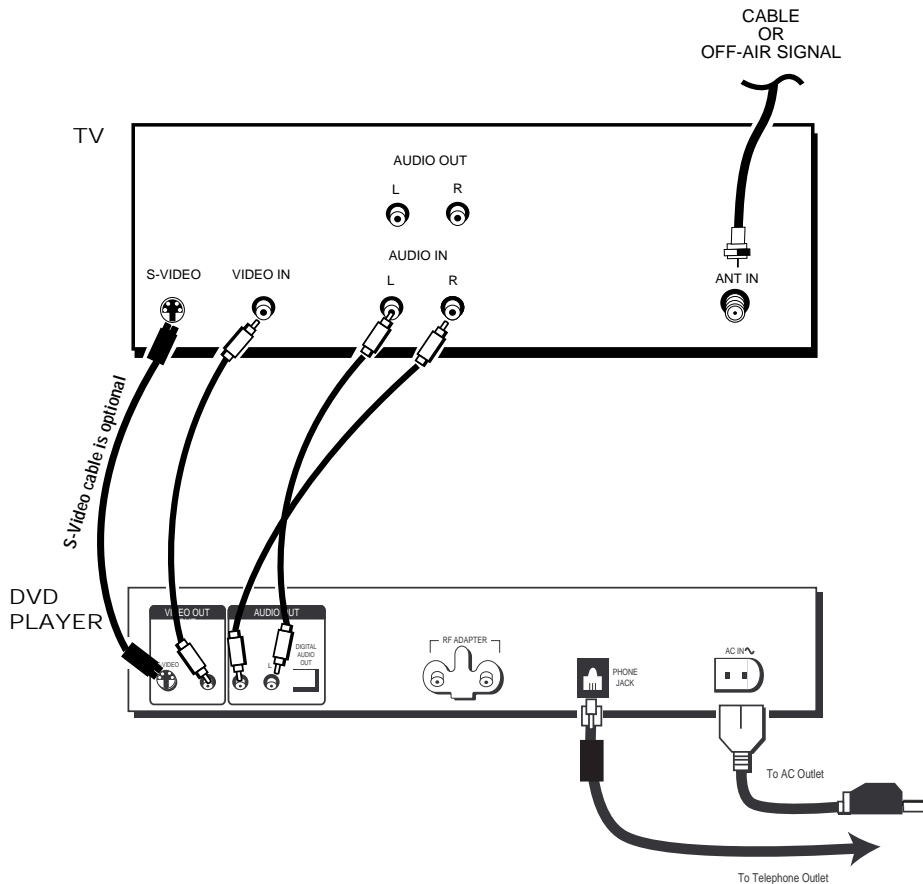

CAUTION

Do not stack electronic components or other objects on top of the DVD Player. See Safety Information on the inside front cover.

DVD Player + TV with Audio/Video Input Jacks

1. Connect the audio cables to the AUDIO OUT L (left – white) and R (right – red) jacks on the back of your DVD Player, and to the corresponding Audio Input jacks on your TV.
2. Connect the video cable (yellow) to the VIDEO OUT jack on the back of your DVD Player, and to the Video Input jack on your TV.
3. If your TV has an S-Video Input jack, connect the S-Video cable to the S-VIDEO OUT jack on the back of your DVD Player and to the S-Video jack on your TV. If your TV doesn't have an S-VIDEO jack, skip this step.
4. If the telephone line cord packed with your DVD Player has a filter attached to one end of the cord, insert that end of the telephone line cord into the PHONE JACK on the back of your DVD Player. Plug the other end into the telephone line splitter (provided), and insert the telephone line splitter into a phone jack.
If the telephone line cord doesn't have a filter attached to it, just insert one end into the DVD Player's PHONE JACK and insert the other end into the telephone line splitter. Insert the telephone line splitter into a phone jack.
5. Connect the AC power cord to the AC IN jack on the back of your DVD Player, and plug the other end into an AC outlet.
6. Turn on your TV and tune it to the Video Input Channel. (If you don't know what channel is the Video Input Channel, please see page 14.)
7. Turn on your DVD Player.

Note: Your cable or off-air connection to the television should not be affected by this connection. Connect your cable or off-air antenna to your television as you normally would. (You may need to consult your television manual for details.)

Setup and Connections

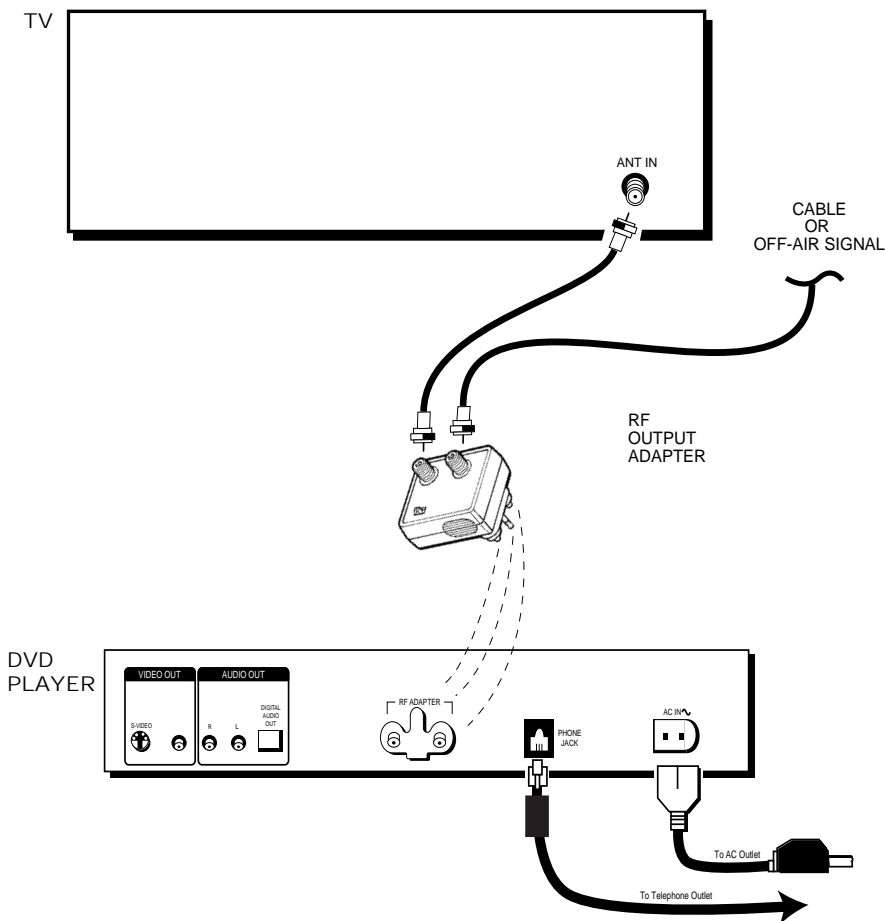

RF Output Adapter Required

You must buy an RF Output Adapter to use this connection. You can order your RF Output Adapter on page 89, or buy one at your local electronics store.

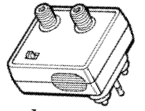

CAUTION

Do not stack electronic components or other objects on top of the DVD Player. See Safety Information on the inside front cover.

DVD Player + TV *without* Audio/Video Input Jacks (Antenna Jack Only)

1. Insert the RF output adapter into the RF ADAPTER jack on the back of your DVD Player.
2. Connect the coaxial cable from your cable or off-air signal to the Antenna Input jack on the RF output adapter.
3. Connect another coaxial cable to the Antenna Input jack on the back of your TV and to the RF output adapter.
4. If the telephone line cord packed with your DVD Player has a filter attached to one end of the cord, insert that end of the telephone line cord into the PHONE JACK on the back of your DVD Player. Plug the other end into the telephone line splitter (provided), and insert the telephone line splitter into a phone jack.

If the telephone line cord doesn't have a filter attached to it, just insert one end into the DVD Player's PHONE JACK and insert the other end into the telephone line splitter. Insert the telephone line splitter into a phone jack.

5. Connect the AC power cord to the AC IN jack on the back of your DVD Player, and plug the other end into an AC outlet.
6. Turn on your TV.
7. Turn your TV to the RF Output Adapter's output channel (the adapter should have a CH 3/4 switch on it that indicates which channel to use on your TV.)
8. Turn on your DVD Player.

Setup and Connections

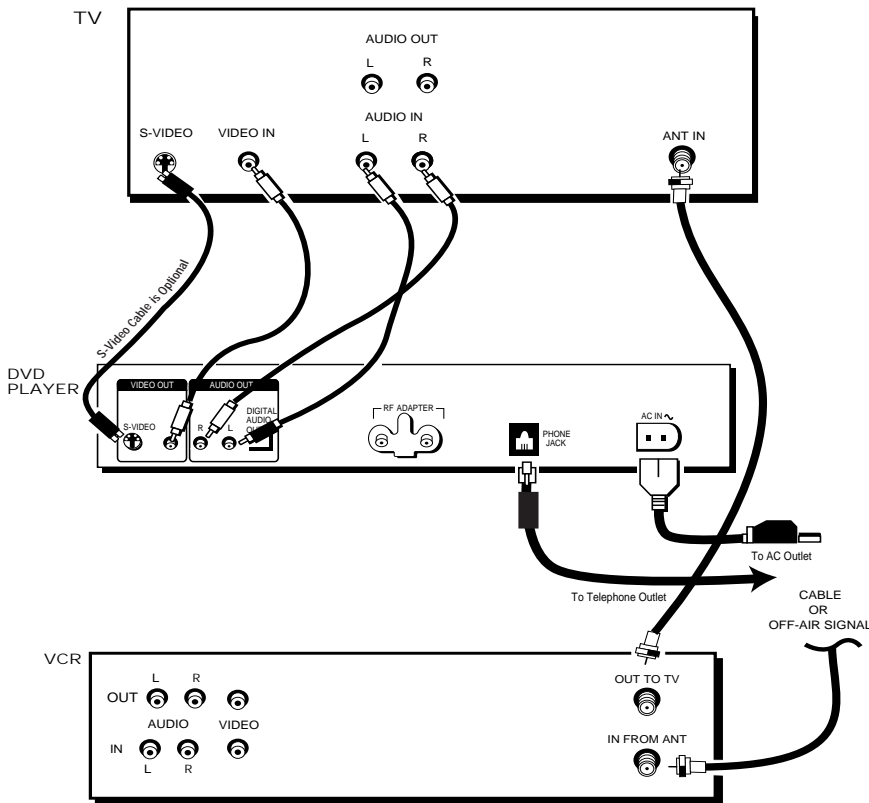

Don't Connect VCR directly to Your DVD Player

Many DVD discs are encoded with copy protection. Because of this, you should only connect your DVD Player directly to your TV, *not* to a VCR. Connecting to a VCR results in a distorted picture from copy-protected discs.

CAUTION

Do not stack electronic components or other objects on top of the DVD Player. See Safety Information on the inside front cover.

DVD Player + TV + VCR

1. Connect the audio cables to the AUDIO OUT L (left – white) and R (right – red) jacks on the back of your DVD Player, and to the corresponding Audio Input jacks on your TV.
2. Connect the video cable (yellow) to the VIDEO OUT jack on the back of your DVD Player, and to the Video Input jack on your TV.
3. If your TV has an S-Video Input jack, connect the S-Video cable to the S-VIDEO OUT jack on the back of your DVD Player and to the S-Video jack on your TV. If your TV doesn't have an S-VIDEO jack, skip this step.
4. Connect the antenna or cable to the Antenna Input jack on the VCR.
5. Connect a coaxial cable to the antenna output jack on the VCR and to the Antenna Input jack on the television.
6. If the telephone line cord packed with your DVD Player has a filter attached to one end of the cord, insert that end of the telephone line cord into the PHONE JACK on the back of your DVD Player. Plug the other end into the telephone line splitter (provided), and insert the telephone line splitter into a phone jack.
If the telephone line cord doesn't have a filter attached to it, just insert one end into the DVD Player's PHONE JACK and insert the other end into the telephone line splitter. Insert the telephone line splitter into a phone jack.
7. Insert the AC power cord into the AC IN jack on the back of your player and into an AC outlet.
8. Turn on your television and tune it to the Video Input Channel. (If you don't know what channel is the Video Input Channel, please see p. 14).
9. Turn on your DVD Player.

To Watch the VCR

Tune your television to channel 3 or 4 depending on how you set the CH3/4 switch on the back of the VCR.

Setup and Connections

DVD Player + TV + Dolby Pro Logic or Dolby Digital or DTS Receiver

To Connect the DVD Player

1. Connect the left and right audio cables to your audio/video receiver and to the AUDIO OUT L (left – white) and R (right – red) jacks on the back of your DVD Player.
2. If you have a Dolby Digital or DTS receiver, insert an optical digital cable (not provided) to the DIGITAL AUDIO OUT jack on the DVD Player and to the Digital Input jack on the back of the receiver. You must also set the *Audio Equipment* setting in the *Setup* menu to the correct setting (*Dolby Digital* or *DTS* – see p. 60 for more information).
3. Connect the video cable to the VIDEO OUT jack on your DVD Player and to the Video Input jack on your TV.

If your TV has an S-Video jack, connect the S-Video cable to the S-VIDEO jack on your DVD Player and to the S-Video jack on your DVD Player. If your TV doesn't have an S-VIDEO jack, don't connect the S-Video cable.

4. If the telephone line cord packed with your DVD Player has a filter attached to one end of the cord, insert that end of the telephone line cord into the PHONE JACK on the back of your DVD Player. Plug the other end into the telephone line splitter (provided), and insert the telephone line splitter into a phone jack.

If the telephone line cord doesn't have a filter attached to it, just insert one end into the DVD Player's PHONE JACK and insert the other end into the telephone line splitter. Insert the telephone line splitter into a phone jack.

5. Connect the AC power cord to the AC IN jack on the back of your DVD Player, and plug the other end into an AC outlet.
6. Turn on your TV.
7. Turn your TV to the Video Input Channel. (If you don't know what channel is the Video Input Channel, please see p. 14).
8. Turn on your DVD Player.

Dolby Digital and DTS

Both Dolby Digital and DTS are audio formats used to record 5.1-channel, audio signals onto the digital track of film. Both of these formats provide six separate channels: left, right, center, left rear, right rear, and common subwoofer.

Remember, the disc will only play 5.1-channel sound if you've connected a DTS or Dolby Digital receiver or decoder and if the disc was recorded in the Dolby Digital or DTS format.

*Dolby Digital is a trademark of Dolby Laboratories Licensing Corporation
DTS is a registered trademark of Digital Theater Systems*

Please Read This Before Using the DIGITAL AUDIO OUT Jack!

This player's digital output jack is designed for a connection to a Dolby Digital or DTS receiver or decoder.

Older digital equipment may not be compatible with the Dolby Digital bitstream. Such a connection can create a high level of noise that may be harmful to your ears, and could damage headphones or speakers.

It is important to choose the correct setting in the DVD Player's Setup menu, especially when you use the DIGITAL AUDIO OUT jack.

If you are connecting your DVD Player to a Dolby Digital receiver, choose the *Dolby Digital* setting in the *Audio Equipment* menu (within the *Setup* menu). If you're connecting your DVD Player to a DTS receiver or decoder, choose the DTS setting in the Audio Equipment menu. For more information, see *Audio Equipment* menu information on p. 60.

Remove the Plastic Covers

If you're using the DIGITAL AUDIO OUT jack, check to see if there is a protective cover inside of the jack and on the ends of the optical digital cable. You must remove these protective covers before inserting the optical digital cable into the jack.

Setup and Connections

DVD Player + TV + Dolby Pro Logic or Dolby Digital or DTS Receiver

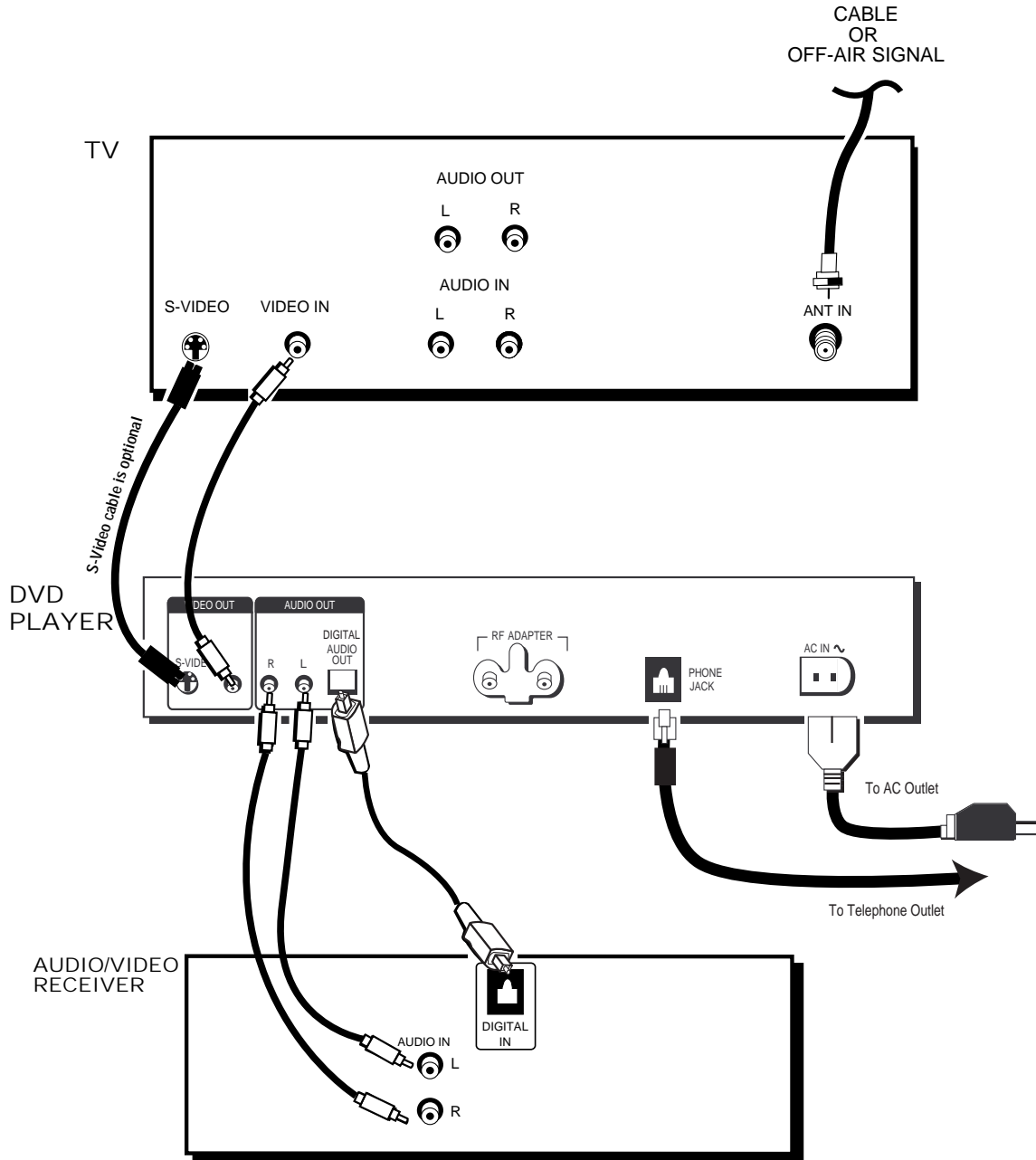

CAUTION

Do not stack electronic components or other objects on top of the DVD Player. See Safety Information on the inside front cover.

Consult the owner's manuals of the additional components you are connecting for more detailed connection information about those particular components.

Setup and Connections

Set the Menu Language

After you turn on your DVD Player the first time, the menu language screen appears.

By default, the player's menu language is set to English. If you want the on-screen menus to appear in English, press OK.

To change the language, press the down arrow button on the remote until the appropriate language is highlighted. Press OK.



Highlight the language you want the menu items to use and press OK on the remote control.

Other Language Options

The Menu Language feature sets the language for the text that appears on the menu screens.

You can choose other languages for subtitles and audio. For more information about subtitle and audio languages, see the section, "Using the Features in the Player's Menu System" on pp. 55-56.

How to Move Around the DVD Player's Menu System

The technical term is "Navigation" — how you move through the DVD Player's menu system.

Even though this book tells you how to select different menu items, you can explore the menu system on your own by following a few "navigational rules."

Press the arrow buttons on the remote to move to different menu items on the screen. To select a menu item, press OK on the remote when the menu item is highlighted.

Highlighted means that the menu item stands out from the other menu items (appears brighter, darker, or a different color). In your DVD Player's menu, a highlighted item appears brighter than the other items on the screen.

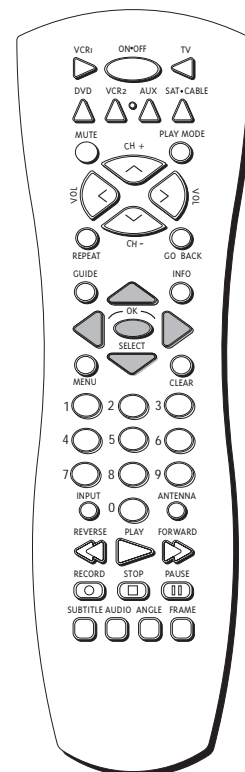

The buttons for navigation are shown in gray in this picture of the remote control. Use the four arrow buttons: up, down, left, and right, to highlight an item on the screen.

Press the OK button to select an item that is highlighted.

Register with Divx

In order to play Divx discs, you must register your player with Divx. Turn on your TV and your DVD Player.

1. Turn your TV to its Video Input Channel (if you don't know which channel on your TV is the Video Input Channel, see page 14).
2. If the DVD Player's main menu (shown at right) isn't on the screen, press STOP on the remote.
3. Press the arrow down button until *Divx* is highlighted, and press OK (the registration screen appears). Call the Divx number that's on the screen: 1-888-NEW-Divx (1-888-639-3489) or register on-line at www.divx.com.
4. Make sure you can see the information on the screen or write it down before calling Divx because the Divx representative will need your player's reference number and ID number (which are listed on the screen).
5. Have your credit card account information handy.

Note: Do not place a disc into your player during registration.

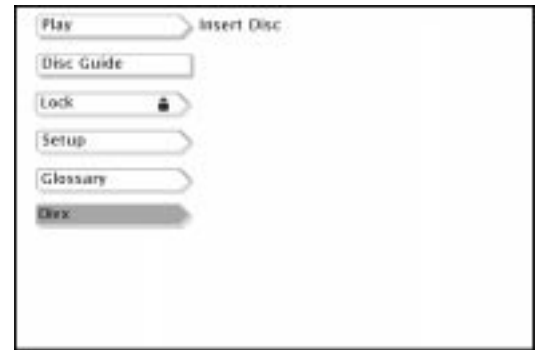

To access the Divx registration screen, highlight *Divx* in the player's main menu and press OK.



To register your player, highlight *Divx* and press OK (the registration screen appears). Call the Divx phone number that appears on your screen. The Divx representative will tell you how to register.

What Happens When My Player Connects to Divx?

Divx sends updated information regarding mail, specials, and new features to your DVD Player.

Divx also receives updated information from the player regarding purchases and other account activity.

A connection between your player and Divx won't interrupt any normal usage of your telephone line, nor will you incur additional charges on your telephone bill.

Do You Need a Dial Prefix?

If you must dial a prefix (such as 9), press the arrow buttons on the remote to highlight *Dial Prefix* on the Divx Registration screen and press OK. Use the number button on your remote that matches your dial prefix number, and press OK.

Don't Place a Disc in the Player during Registration

The disc tray must be empty (no disc in the tray) during registration.

Setup and Connections

How to Find Your TV's Video Input Channel

You need to tune your TV to the Video Input Channel (or S-Video Channel if you connected the S-Video cable to your TV and to your DVD Player) to see the DVD Player's menu and to see the content that's on a disc. The video channel on TVs varies for different brands and different models. Below are some things to try.

- If your TV brand is RCA, GE, or PROSCAN, press the TV button on the remote that came with your DVD Player. Then press the INPUT button on the remote.
- If you have another brand, consult your TV Owner's Manual.

If those options don't work, try the following ideas. You might access the Video Input Channel by:

- pressing a button on the remote (see table below)
- selecting it from the TV's menu system (see table below)
- tuning directly to it by pressing a specific channel number (see table below)
- going through all of the channels in the channel list by pressing the channel up or down buttons on the TV.

Some common scenarios are listed in Video Input Channel Variations table that follows:

Video Input Channel Variations		
Button/switch on the TV	Button on the TV Remote	Channel #
VIDEO	VID 1	00
SIGNAL	LINE	90
VID 1	VID	91
VID 2	VIDEO	92
S-VID	S-VID	93
S-VIDEO	INPUT	VID 1
	S-VIDEO	VID 2
	SOURCE	
	AUX	

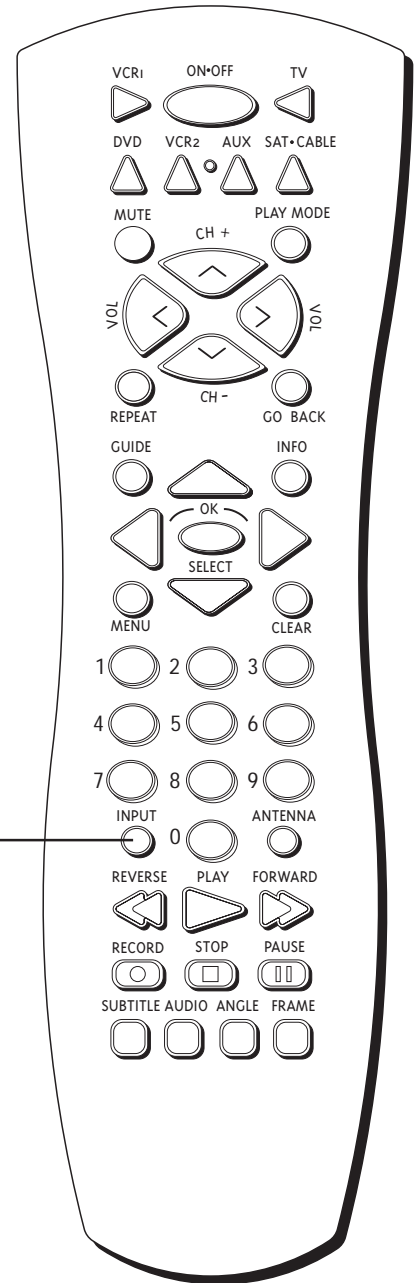

Tour of the Remote Control

You can use this remote to control compatible components. The component buttons are programmed to operate most PROSCAN, RCA, and GE components. The remote can also operate other brands of electronics components, but you must manually program it to do so. (See "Programming the Remote" on page 84.)

Component Buttons (*listed alphabetically*)

In order for the remote control to operate a specific component, you must press the appropriate component button to tell the remote which component to operate.

- AUX** Tells the remote to control an alternative component, such as an Audio/Video Receiver.
- DVD** Press this button to turn on the DVD Player and to set the remote to control the DVD Player.
- SAT•CABLE** Press this button to turn on most RCA, GE, or PROSCAN satellite receivers. Used with ON•OFF button to turn on some other brands of satellite receivers.
- TV** Press this button to turn on most RCA, GE, or PROSCAN TVs and set the remote to control the TV. Used with ON•OFF button to turn on some other brands of TVs.
- VCR1** Press this button to turn on most RCA, GE, or PROSCAN VCRs and to set the remote to control the VCR. Used with ON•OFF button to turn on some brands of VCRs.
- VCR 2** Press this button to turn on a second RCA, GE, or PROSCAN VCR and to set the remote to control the VCR. Used with ON•OFF button to turn on some other brands of VCRs.

The Buttons Might Operate Differently for Other Components

The buttons on this remote control may operate differently for other components, especially when you're using the menu system of another component. For example, to select a menu item in your DVD Player's menu you press the OK button. If you have an RCA satellite system, you would press the MENU or the INFO button on this remote control to select a menu item.

(continued on next page)

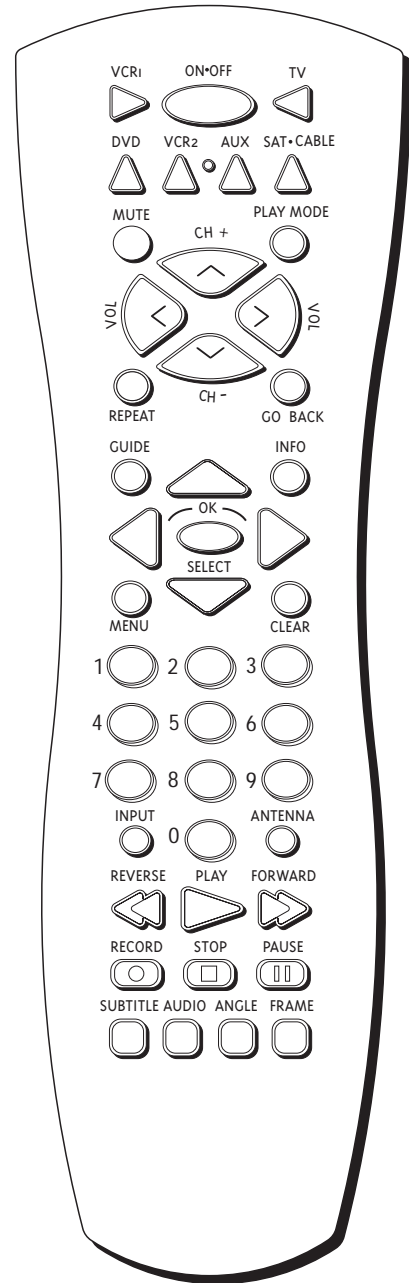

The component buttons are at the top of the remote control, near the ON•OFF button. They are: VCR1, TV, DVD, VCR2, AUX, SAT•CABLE.

Setup and Connections

Other Remote Control Buttons (*listed alphabetically*)

This section describes what each button does when the remote is operating the DVD Player. You put the remote in "DVD mode" by pressing the DVD button on the remote.

The buttons on the remote may operate differently when the remote is controlling other components.

Example: When the remote is operating the DVD Player, pressing CH+ takes you to the beginning of the next chapter or track on the disc. When the remote is operating the TV, pressing CH+ takes you to the next channel.

Arrow buttons Use the arrow buttons (left, right, up, and down) to move through the on-screen menu. You highlight a menu item by pressing the arrow buttons. You select a highlighted item by pressing the OK button.

ANGLE Press this button to access various camera angles on a disc (if the disc contains multiple camera angles).

ANTENNA Lets you change the source of the video signal from satellite signals to an off-air antenna or cable signal and vice versa.

AUDIO Use this button to access various audio languages on a disc (if the disc contains multiple audio streams).

CH+ Allows you to move to the beginning of the next chapter or track on a disc (in effect, "skipping" the chapter or track).

CH- Allows you to move to the beginning of the preceding chapter or track on a disc (in effect, "skipping" the chapter or track).

CLEAR Clears the Info Display from the screen when you're playing a disc. When you're using the DVD Player's menu system, press CLEAR to go back to the DVD Player's main menu.

FORWARD Allows you to search forward through a disc while it is in play mode (or slow speed search in pause mode).

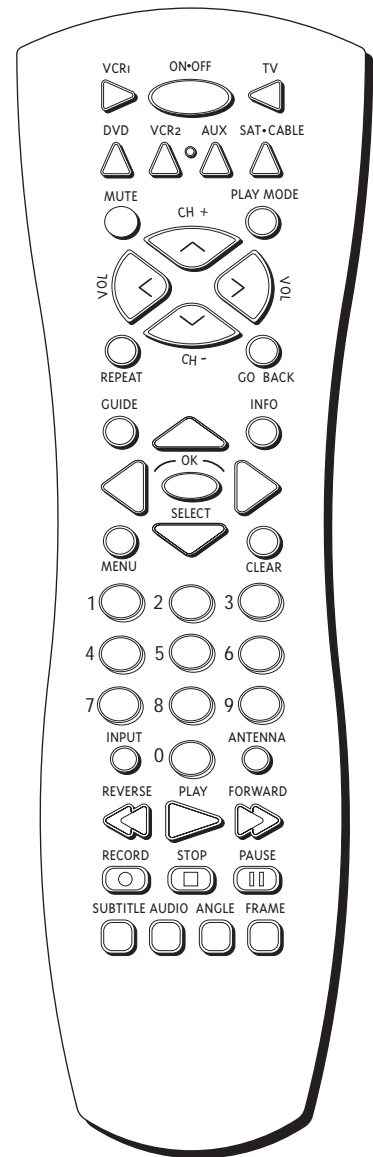

NOTE: The remote packed with your DVD Player is programmed to operate most RCA, GE, and PROSCAN components. The remote can also operate other brands of electronics components, but you must program it to do so (see page 86).

FRAME- Takes you to the previous frame when you're playing a disc.

GO BACK When you're using the DVD Player's menu system, press this button to return to the preceding menu screen.

GUIDE Allows you to see the titles that are available on the current disc (if the disc contains a guide menu).

INFO Press this button while you're playing a disc to see the on-screen Info Display. The Info Display contains various playback features and gives you information about the disc you're playing.

INPUT Use with the TV button to tune to the Video Input Channel.

MENU Press this button to see the disc's menu when you're playing a disc (press it again to resume playback).

MUTE Lowers the volume to an inaudible level.

Number buttons (0-9) Use the number buttons to input information such as chapter numbers, track numbers, or to make selections on some menu screens.

OK (same as SELECT button) Press this button to select a highlighted menu item.

PAUSE Pauses disc play. Also used for frame advance.

PLAY Begins disc play (and closes disc tray if it is open).

PLAY MODE When a disc is playing, press this button to access the play mode menu within the Info Display.

ON•OFF Turns on the player when it is in standby mode; or puts the player in standby mode when power is on.

REPEAT Press this button to go to the Repeat menu within the Info Display. You can repeat a chapter, track, or an entire disc.

REVERSE Allows you to search backward through a disc while it is in play mode (or slow speed search in pause mode).

SELECT (same as OK button) Press this button to select a highlighted menu item.

STOP Stops disc play. You can also press STOP to remove the screen saver from the screen to see the DVD Player's main menu.

SUBTITLE When a disc is playing, press this button to make subtitles appear and disappear on the screen (if the disc was created with subtitles).

VOL up and down Adjusts the TV's volume level.

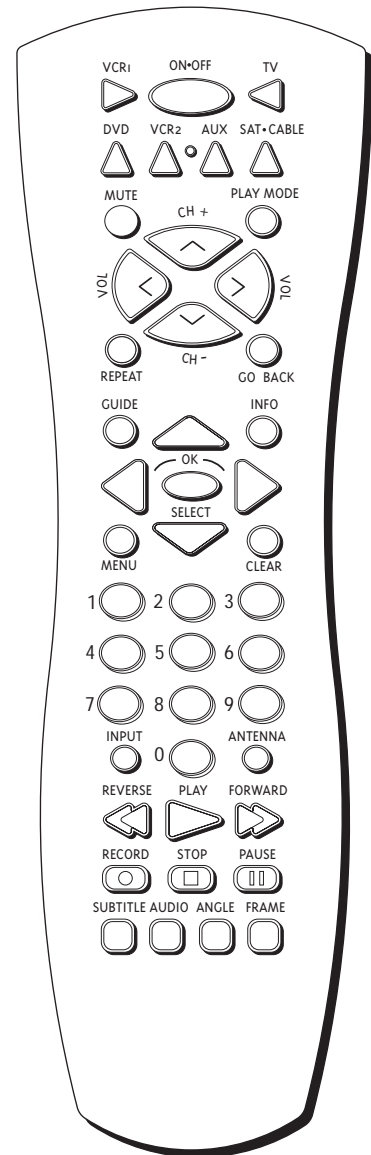

Setup and Connections

Helpful Hints about the Remote

Pick the Right Mode

Do you keep pressing the buttons on your remote control and nothing happens? The most common solution, according to our call center representatives, is putting the remote in the correct mode.

The Universal Remote Control packed with your player is able to operate many different components, but you have to tell the remote which component you want it to operate. If the remote is operating the TV, it's in TV mode. If it's operating the VCR, it's in VCR mode, etc. So make sure you press the appropriate component button on the remote that matches the component you want the remote to operate.

Point the Remote in the Right Direction

Another tip— point the remote at the component. When you want the remote to operate the DVD Player, point the remote at the DVD Player *not* the TV. The remote has to be pointed in the correct direction and toward the correct component in order for the remote control's signal to communicate with the sensor on the component. You must make sure there is a clear path between the remote control and the component you want to operate so the signal isn't blocked.

The Buttons Might Operate Differently for Other Components

The buttons on this remote control may operate differently for other components, especially when you're using the menu system of another component. For example, to select a menu item in your DVD Player's menu you press the OK button. If you have an RCA satellite system, you would press the MENU or the INFO button on this remote control to select a menu item.

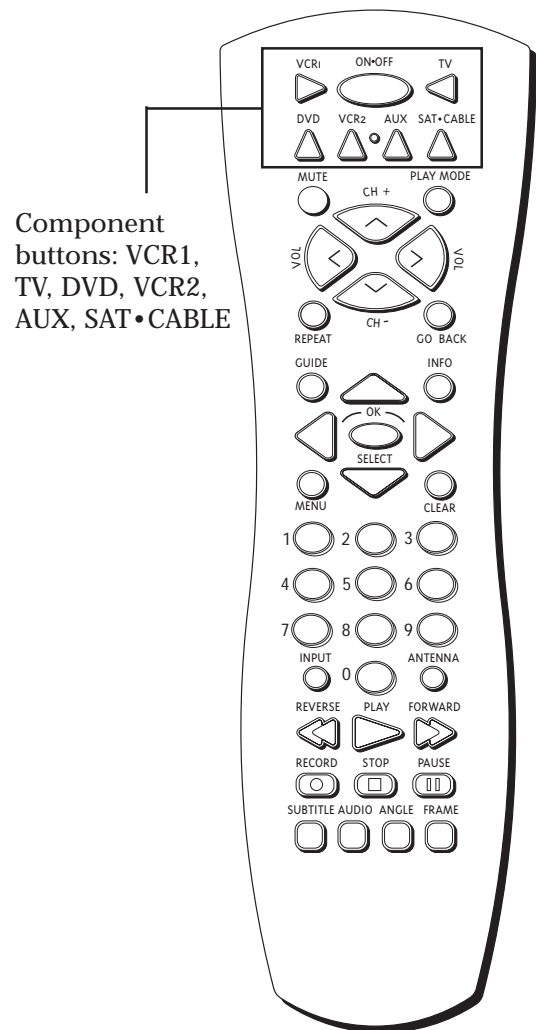

Playing Digital Video Discs

A New Way of Looking At Things

In this section you'll learn how to use your DVD Player to play Digital Video Discs. Detailed information about Divx discs in the next section.

You'll use the on-screen Info Display while you're playing a disc to use the different playback features of each disc. Please remember, an Info Display option will only work if the disc was programmed to support that option when it was made. For example, if you choose subtitles on the Info display, the subtitles will only appear if the disc was created with subtitles.

Regional Coding

Both the DVD Player and the discs are coded by region. These regional codes must match in order for the disc to play. If the codes don't match, the disc won't play. This player's code is Region No. 1.

Section Overview:

- **Loading and Playing Discs**
- **Using a Disc Menu**
- **Disc Playback Features**
- **Using the On-screen Info Display**



Playing Digital Video Discs

Loading and Playing a Disc

Before you load a disc, make sure that it is compatible with the player. The following discs CANNOT be used with this player:

- Video CDs
- Laserdiscs
- CD-I, CD-ROM, CD-R, DVD-ROM
- MiniDiscs
- Discs recorded using other broadcast standards (i.e. PAL or SECAM)
- CD-G discs (play audio only, not graphics)

To Load and Play a Disc

Make sure you've connected your DVD Player correctly (see "Setup and Connections") and turned it on (press ON•OFF on the player or press the DVD button on the remote control).

1. Press the OPEN•CLOSE button on the front of the DVD Player (the disc tray opens).
2. Place a disc gently into the tray with the disc's label facing up (double-sided discs have a label on both sides near the center).
3. Press the OPEN•CLOSE or PLAY button (the disc tray closes).

The DVD Player reads the disc's table of contents, and then one of three things happens depending on how the disc was "authored"—or programmed:

- The disc starts playing.
- The disc menu appears on the screen.
- The DVD Player's main menu appears on the screen (press PLAY to begin playing the disc).

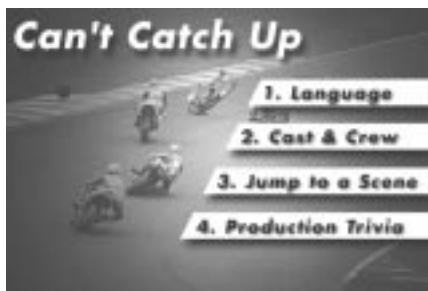

An example of a disc menu. The menus on discs vary because the disc menu is created by the disc's author.

4. Press STOP to stop playback.



This is a single-sided disc (label side up)

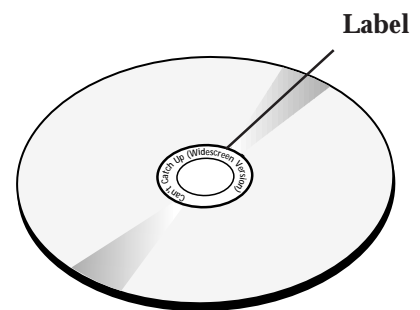

This is a double-sided disc

Accessing the Disc Menu

Many discs skip the disc menu and start playing automatically. To access the disc menu when you're playing a disc, press MENU on the remote.

Resume Feature

When you stop playing a disc, the player remembers where you stopped. When you start playing the disc again, the DVD Player picks up where you left off (unless the disc is removed or the player is unplugged).

If you press the STOP button twice accidentally, the resume feature won't work.

Using a Disc Menu

A disc is capable of having a menu—its own on-screen menu system is separate from the player's menu system. The disc menu may allow you to change features such as language and playback settings.

Although the content and operation of disc menus vary from disc to disc, the following example should give you a pretty good idea of what to expect.

1. While the disc is playing, press MENU (the disc menu appears).
2. Press the up and down arrow buttons to highlight the section of the disc menu you want to choose, and press OK.



The Language setting is highlighted: press OK to see the language options on this disc.

3. Press the up and down arrows to select a language, and press OK.



English is highlighted: press OK to play the disc with English dialog.

4. Press MENU to resume playback.

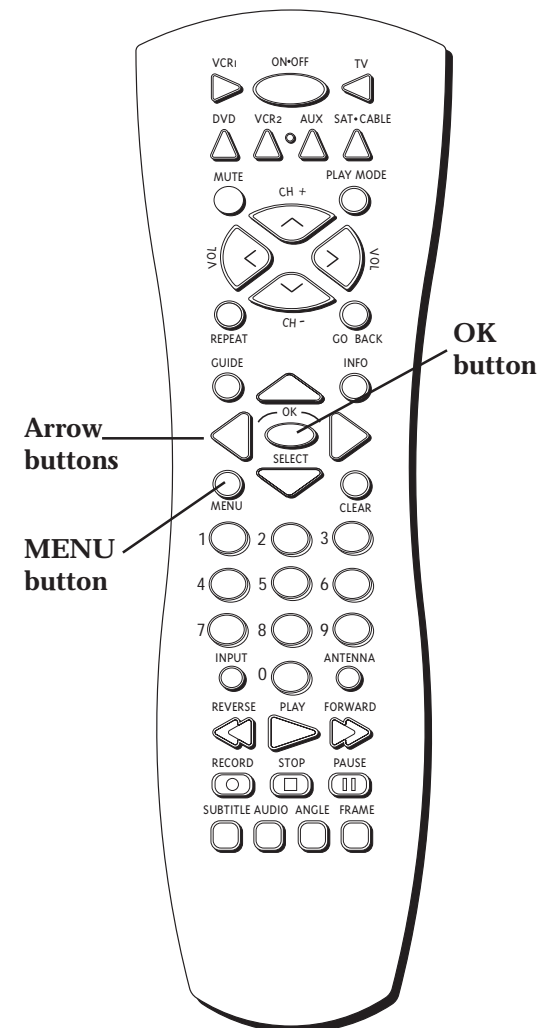

Default Settings

Any settings you change on the disc menu only override the settings in the DVD Player's menu system temporarily.

Default settings are the settings that you set up in the DVD Player's menu system. To change the default settings, see the section "Using the Features in the Menu System" on pp. 45-62.

Playing Digital Video Discs

Disc Playback Features

Fast Motion Playback (Picture Scan)

To scan through the disc when you're playing it, use the Picture Scan feature.

1. Press the REVERSE or FORWARD button on the remote when you're playing a disc.
2. Press the button again to scan at a faster speed.
3. Press the PLAY button at any time to resume normal playback.

Notes:

You won't hear the sound (audio) on the disc when you're using the picture scan feature.

Playback features aren't available during the opening credits of a movie.

Freeze Frame and Frame Advance

1. Press PAUSE when a disc is playing to freeze the picture.
2. Each time you press the PAUSE button, the picture advances one frame. Each time you press the FRAME- button, the picture reverses one frame.
3. Press PLAY to resume normal playback.

Note: Playback features aren't available during the opening credits of a movie.

Slow Motion Playback (in Freeze Frame Mode)

While the disc is in freeze frame mode, you can use slow motion playback.

1. While the disc is playing, press PAUSE on the remote.
2. Press the REVERSE or the FORWARD button.
3. Press the button again to increase the slow motion, playback speed.
4. Press PLAY to resume normal playback.

Note: Playback features aren't available during the opening credits of a movie.

Chapter Advance

While a disc is playing, you can go forward or backward a chapter at a time.

- Press CH+ and/or CH- to go forward and backward through the disc a chapter at a time.

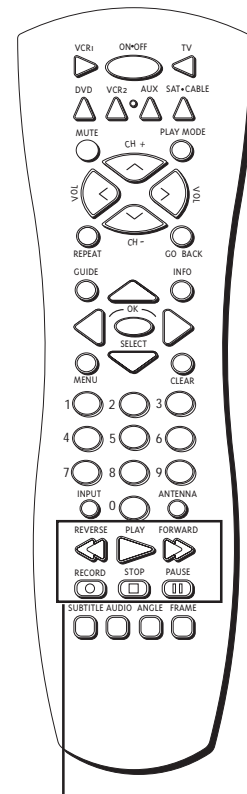

Playback buttons

Playback Features Might Not Be Available During Opening Credits

Playback features, such as fast forward, might not work during the opening credits and warning information that appear on the screen at the beginning of a movie because of the way the movie on the disc is formatted.

Playback features are disc-dependent, and may not work with all discs.

Slow Motion Backward

Scanning backward doesn't provide as clear of a picture as searching forward. The picture may appear "jumpy."

This is the nature of MPEG-2, which is the digital video data standard of the Motion Pictures Experts Group (MPEG) that allows more content to fit on one disc.

Using the On-Screen Info Display

The on-screen Info Display contains many playback features. To see the Info Display, press INFO while a disc is playing. Use the arrow buttons to move through the different features in the Info Display. Each feature is illustrated with an icon.

Use the arrow buttons to highlight an Info Display icon. When an icon is highlighted, press OK to select it.

Please remember, you can only access the Info Display when you're playing a disc. Also, the Info Display features are only available if the disc was created with that particular feature (i.e., if you select the Subtitle icon, you won't be able to change the subtitle language unless the author of the disc created the disc with subtitles).

The invalid symbol  appears on the screen when you press a button that doesn't have any function. If one of the icons is "grayed out," the Info Display feature isn't available for the disc you're playing. To make the Info Display disappear from the screen, press INFO or CLEAR on the remote control.

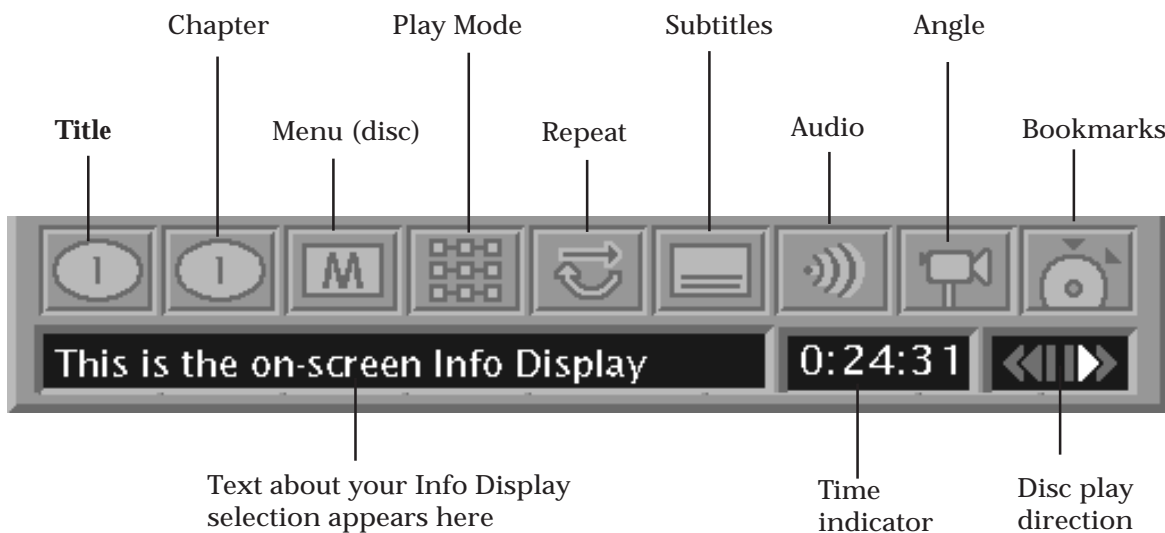

Selecting a Title

Some discs contain more than one Title. For example, there might be four movies on one disc (each movie might be considered a title).

1. Make sure your remote control is in DVD mode (by pressing the DVD button on the remote).
2. During disc playback, press INFO on the remote.
3. If the Title icon on the Info Display isn't highlighted, press the appropriate arrow button(s) to highlight it.
4. Use the number button(s) on the remote to enter the title number.
5. Press OK when the Title you want to play, appears in the text window.

Note:

Some discs only have one title.

Playing Digital Video Discs



Selecting a Chapter

Because DVD discs use digital technology, a title can be divided into individual chapters (similar to tracks on a CD). You can skip to a specific chapter by using the Chapter section in the Info Display.

1. Make sure your remote control is in DVD mode (by pressing the DVD button on the remote).
2. While a disc is playing, press INFO on the remote.
3. Press the arrow right button until the Chapter icon is highlighted.
4. Use the number buttons on the remote to enter the number of the chapter you want to play.
5. Press OK.

Notes:

- The Chapter feature won't work if the disc isn't formatted with separate chapters.
- When you enter a one-digit chapter number, you may have to press OK after pressing the number button. This varies depending on the number of chapters within the title you're playing.



Using the Menu Icon

The Menu icon on the Info Display accesses the disc's menu.

1. Make sure your remote is in DVD mode (by pressing the DVD button on the remote control).
2. While a disc is playing, press INFO on the remote (the Info Display appears on the screen).
3. Press the right arrow button until the Menu icon is highlighted and then press OK.
4. Press MENU to start playing the disc again.

Shortcut: Press MENU on the remote while the disc is playing (the disc's menu appears).

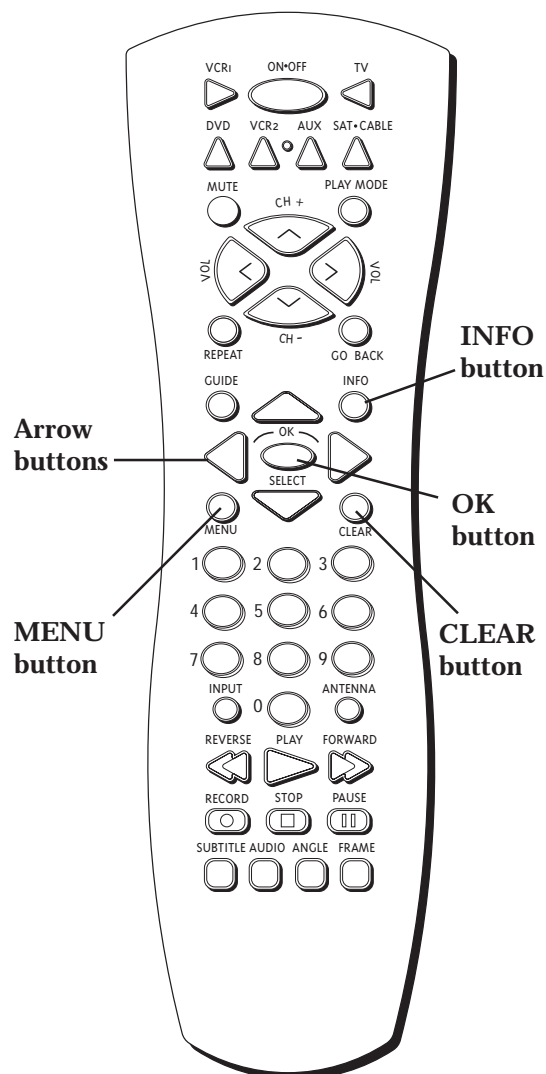



Selecting Different Play Modes

There are three play modes available in the Info Display:

- Standard
- Random
- Program

To change the way a disc plays:

1. Press INFO on the remote.
2. Press the arrow right button until the Play Mode icon is highlighted, and press OK (the Play Mode menu appears).



3. Press the arrow buttons to highlight one of the three play modes (*Standard*, *Random*, or *Program*), and press OK.
4. Press the arrow down button to highlight *Done*. Press OK.
5. To make the menu disappear from the screen, press CLEAR on the remote.

Notes:

- Shortcut: Press the PLAY MODE button on the remote control when the Info Display is on the screen instead of using the arrow buttons to highlight the Play Mode icon.
- If a Play Mode option isn't available for the disc you're playing, you won't be able to highlight the selection.
- You must create the program in order to use the Program option (see "How to Create a Program" on p. 48).

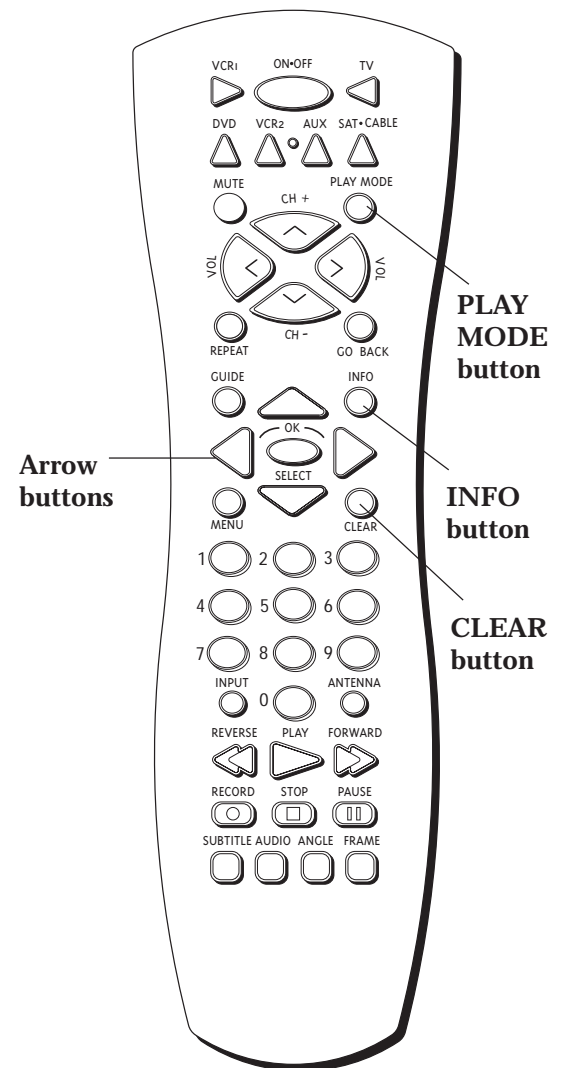

Using the Repeat Feature

There are four Repeat options:

- Disc – repeats the disc that is playing
- Title – repeats the title that is playing
- Chapter – repeats the chapter that is playing
- A•B – Set the beginning (point A) and the end (point B) to make this part of the movie play repeatedly.

(continued on next page)

Playing Digital Video Discs

To Use Repeat:

1. Make sure your remote control is in DVD mode (by pressing the DVD button on the remote).
2. While a disc is playing, press INFO on the remote (the Info Display appears).
3. Press the right arrow button until the Repeat icon is highlighted. Press OK (the Repeat menu appears).

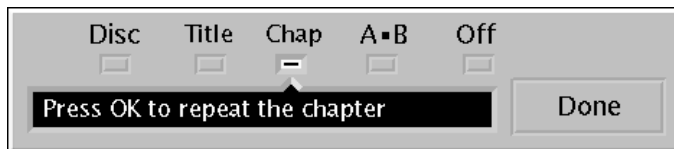

4. Press the arrow buttons to highlight one of the Repeat options. Press OK.
5. Press the arrow down button to highlight *Done*.
6. Press OK (the Info Display appears on the screen with the Repeat icon blinking to inform you that the Repeat feature is on).

Shortcut: Press the REPEAT button on the remote when the Info Display is on the screen instead of using the arrow buttons to highlight the icon.

A•B Repeat Deserves Some Extra Instruction

A•B Repeat lets you repeat a specific segment on the disc that you define. For example, my son loves to watch the dogfight in the movie *Top Gun*. To watch this scene over and over:

1. Press INFO on the remote and select the Repeat icon from the Info Display.
2. Press the right arrow button to select A•B (*Press OK to set the A point* appears in the text window).
3. Press FORWARD or REVERSE on the remote to move to the part of the disc that you want to be the beginning of the segment that is going to repeat (the A point).
4. Press OK.
5. Press FORWARD or REVERSE on the remote to go to the part of the disc that you want to be the end of the segment that will repeat (the B point).
6. Press OK.
7. Press the down arrow to highlight *Done* and press OK (the Info Display appears on the screen with the Repeat icon blinking).
8. To make the Info Display disappear from the screen, press CLEAR on the remote.

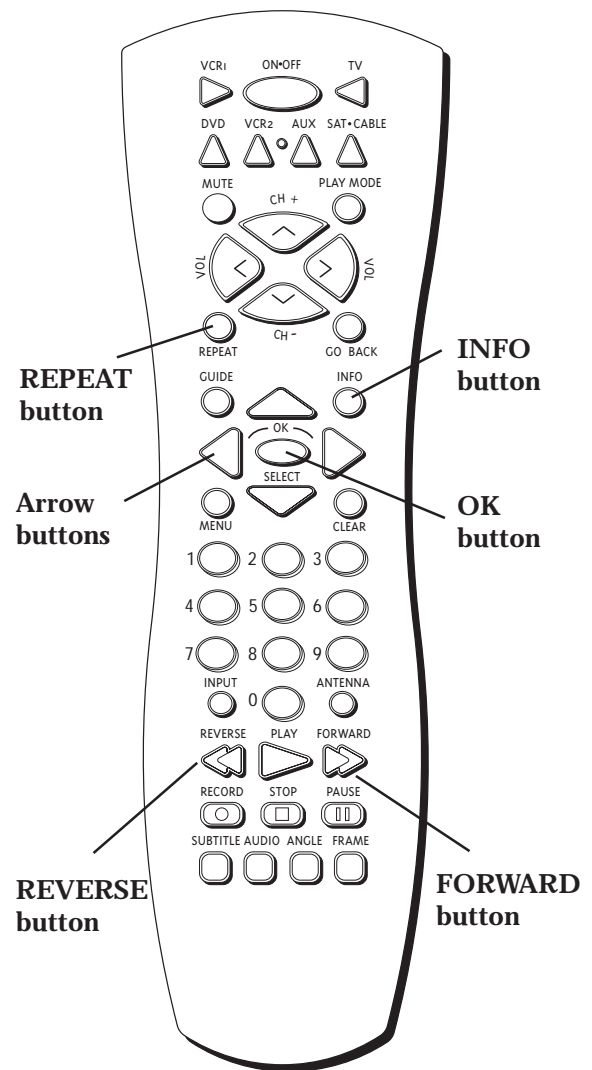

How to Cancel Repeat

There are three ways to cancel Repeat:

- Press STOP twice.
- Go to the Repeat Menu in the Info Display and select *Off*.
- Eject the disc.



Changing the Subtitle Language

You can change the Subtitle language while you're watching a disc (but only if the disc was created with subtitles).

1. Make sure your remote control is in DVD mode (by pressing the DVD button on the remote).
2. While a disc is playing, press INFO on the remote.
3. Press the right arrow button until the Subtitle icon is highlighted. Press OK (the Subtitle menu appears).



4. Press the right and left arrow buttons to see the different subtitle languages that are available on the disc.
5. When the subtitle language you want to use appears in the text window, press OK on the remote.
6. Press the arrow down button to highlight *Done*. Press OK.
7. To make the menu disappear from the screen, press the CLEAR button on the remote.

Notes:

- The subtitle feature only works if the disc was created with subtitles.
- When you choose a subtitle language from the Info Display, you only override the subtitle language setting in the DVD Player's main menu (in the *Lang Prefs* menu within the *Setup* menu) temporarily.

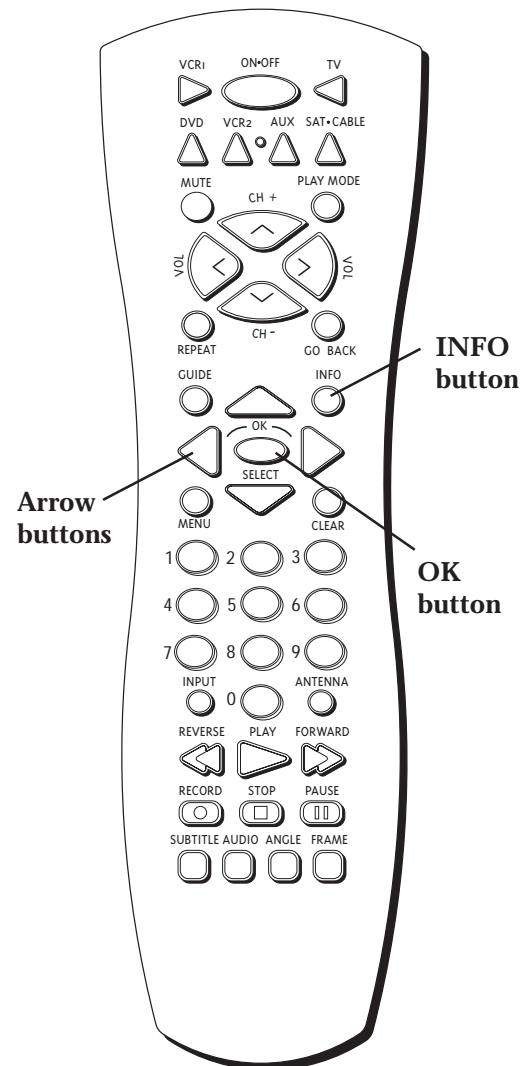

Playing Digital Video Discs



Changing the Audio Language

If the disc was created with different language tracks, you can use the Info Display to temporarily change the DVD Player's Audio setting.

1. Make sure your remote control is in DVD mode (by pressing the DVD button on the remote).
2. Press INFO on the remote. Press the arrow right button until the Audio icon on the Info Display is highlighted.
3. Press OK (the Audio Menu appears).



4. Press the right and left arrow buttons to see the audio languages that are available on the disc.
5. When the audio language you want to use appears in the text window, press OK on the remote.
6. Press the down arrow button to highlight *Done* and press OK.
7. To make the menu disappear from the screen, press CLEAR on the remote.

Notes:

- The language feature only works if the disc was created with multiple audio tracks.
- When you choose an audio language from the Info Display, you only override the audio language setting in the DVD Player's main menu (in the *Lang Prefs* menu within the *Setup* menu) temporarily.
- Shortcut: Press the AUDIO button on the remote control when the Info Display is on the screen instead of using the arrow buttons to highlight the Audio icon.

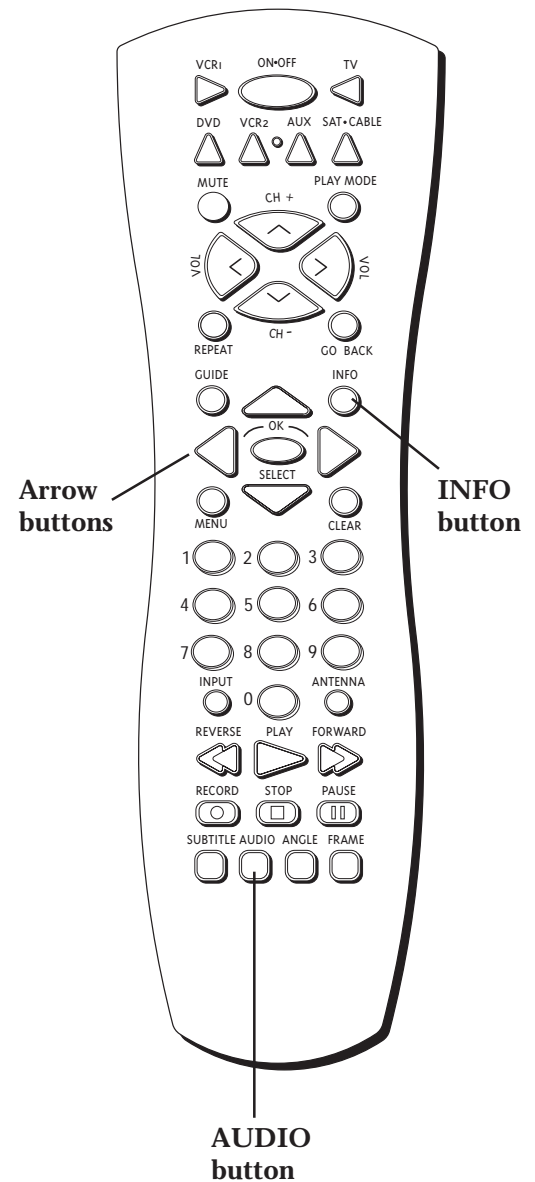



Changing the Camera Angle

Some discs contain multiple angles of a particular scene or sequence. If the disc only has one angle, this feature won't work.

1. Make sure your remote control is in DVD mode (by pressing the DVD button on the remote).
2. While a disc is playing, press INFO on the remote (the Info Display appears).
3. Press the right arrow button until the Camera Angle icon is highlighted, and press OK (the Angle Menu appears).



4. Use the right and left arrow buttons to highlight an angle.
5. When the angle you want to use appears in the text window, press OK on the remote.
6. Press the down arrow button to highlight *Done* and press OK.
7. To make the Info Display disappear from the screen, press CLEAR.

Shortcut: Press the ANGLE button on the remote control when the Info Display is on the screen instead of using the arrow buttons to highlight the Angle icon.

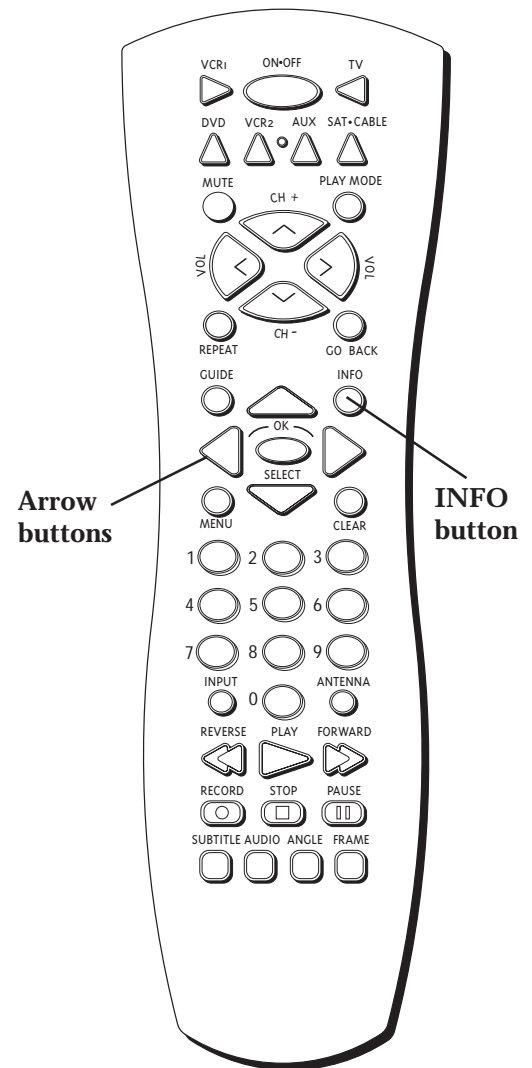

Using Bookmarks

The bookmark feature lets you mark a point on the disc that you can go to quickly. You can store up to 10 bookmarks.

Storing a Bookmark

1. Make sure your remote control is in DVD mode (by pressing the DVD button on the remote).
2. While a disc is playing, press INFO on the remote.

continued on next page

Playing Digital Video Discs

Storing a Bookmark (*continued from previous page*)

3. Use the right arrow button to highlight the Bookmark icon.
4. Press OK (the Bookmark Menu appears).



5. When you reach the scene you want to mark, press OK.
6. Press the arrow down button to highlight *Done*. Press OK.
7. Press CLEAR on the remote to make the Info Display disappear from the screen.

Recalling a Bookmarked Scene

1. While you're playing a disc, press INFO on the remote (the Info Display appears).
2. Press the right arrow buttons on the remote until the Bookmark icon is highlighted.
3. Press OK.
4. Press the up arrow button to get to the *Go To* part of the Bookmark menu.
5. Use the right arrow button to select the bookmarked scene you want to activate.
6. Press OK to activate the bookmark.
7. To make the Info Display disappear from the screen, press CLEAR on the remote.

Clearing a Bookmark

The bookmark is cleared each time a disc is removed from the player or when the power is turned off.

If all 10 bookmarks are in use, you can still mark new scenes, but the previous bookmarks will be erased.

All About Divx

Your Divx¹-enhanced DVD Player provides you with the newest in home entertainment technology. The Divx feature enables you to enjoy your favorite movies at home with convenience, flexibility, and affordability. To use the Divx feature, please make sure that you have connected a working telephone line to your DVD Player and that you have registered with Divx:

1-888-NEW-DIVX (1-888-639-3489). Instructions for Divx Registration are in the "Setup and Connections" section, page 13.

The purchase price of a Divx disc includes a two-day viewing period which begins when you insert the Divx disc into your DVD Player for the first time and press play. This could be the day you purchase the disc, the next week, or even months later. Additional two-day viewing periods or DivxSilver (purchasing unlimited play) can be purchased at any time by following the on-screen instructions.

Divx provides the quality of digital pictures and sound; the freedom of no returns and no late fees; the availability of hot feature titles all the time; and the convenience of an affordable, home movie collection.

Divx discs are available at a number of retail locations and through the Divx site on the world wide web (www.divx.com).

Numbers to Know

Divx Registration: 1-888-NEW-DIVX
1-888-639-3489

Divx Customer Service: 1-888-456-DIVX
1-888-456-3489

¹ DIVX and Thomson Consumer Electronics are unaffiliated entities.



All About Divx

How to Play Divx Discs

1. Turn on your DVD Player.
2. Press OPEN•CLOSE on your DVD Player.
3. Place the Divx disc into the tray (Divx logo facing up and make sure the disc lays flat).
4. Press PLAY on your remote (the disc tray closes).

If YOUR PLAYER HAS NEVER PLAYED this disc before, it will display the authorization screen illustrated at right. This screen lets you know what options you have BEFORE you go ahead and play the movie.

If the Divx disc is “brand new” and it has never been played on any player, just highlight *Play Movie* on your TV screen and press OK. The initial 2-day viewing period will begin and no charges will be billed to your Divx account.

-- OR --

If the disc has been played on your player and there is still time remaining in the viewing period, the Divx disc will begin playing the movie automatically when the disc tray closes and it will not show you the authorization screen.

If the original viewing period on the Divx disc HAS BEEN USED (i.e., the Divx disc’s 2-day viewing period has been played on your player or on someone else’s player before), then the authorization screen advises you that your account will be charged the amount which appears on your TV screen. If you agree to the price, highlight *Play Movie* and press the OK button on your remote control.

Notes:

- If the time remaining on any viewing period is less than the total playing time of the movie, your player will play the entire movie without additional charges. Once the viewing period expires, you may not be able to use certain features such as stop or pause.
- The charge for additional viewing periods and the charge for purchasing unlimited play (DivxSilver) may vary from title to title.

Note:

If you have more than one Divx enhanced DVD Player registered to your account, you may play a Divx disc on any or all of those players during the viewing period without incurring additional charges. Remember that only the player which was used to begin the viewing period will accurately track the elapsed time of the viewing period. Therefore, the 2nd player will repeat the authorization screen. Once the players call the Divx transaction processing system, your account information will be updated to correctly reflect the use of a single viewing period and no additional charges will appear on your statement.

Connect the Telephone Line Cord

You must connect the telephone line cord to the back of your DVD Player and to a working phone jack in order to use all of the Divx features. (See p. 4).



If the original viewing period on the Divx disc has been used, an authorization screen similar to the one above will appear.

Playback Features

To learn more about playback features (reverse, skipping chapters, playing frame by frame, etc.), go to page 22 in the *Playing Digital Video Discs* section of this book.

View Movie Settings

View Movie Settings shows the rating level and format selected for the Divx disc that's in your player.

To see the Movie Settings:

1. Insert a Divx disc into the player and press OPEN•CLOSE. Highlight the *View Movie Settings* option on the authorization menu and press OK. (See p. 32.)

-- OR --

1. While you're playing a Divx disc, press MENU on the remote (the disc menu appears).
2. Press the appropriate arrow button(s) on the remote to highlight *View Movie Settings* and press the OK button on the remote control (the Movie Settings menu appears).
3. To exit the *View Movie Settings* menu, press the OK button.
4. Press the arrow buttons on the remote to highlight *Resume Play* or *Play Movie* (whichever option appears), and press OK.

Note: Change Movie Settings

Some Divx disc menus might display the option *Change Movie Settings* instead of *View Movie Settings*. *Change Movie Settings* allows you to change the rating level, format, sound track, and use of subtitles and camera angles when any or all of those choices have been included on the disc. If your Divx disc contains this option, use the appropriate arrow buttons on the remote to highlight an option. Press OK to select the highlighted option.



The *View Movie Settings* option shows you the rating level and format of the disc. Press MENU on the remote while the disc is playing and select *View Movie Settings*.



Some discs might be formatted with *Change Movie Settings* instead of *View Movie Settings*.

All About Divx

View Movie Status

View Movie Status shows you how much time, if any, is remaining on the Divx disc's viewing period.

To see *Movie Status*:

1. While you're playing a Divx disc, press MENU on the remote.
2. Press the appropriate arrow button(s) on the remote to highlight *View Movie Status* and press the OK button on the remote (the *Movie Status* menu appears).
3. To exit the *Movie Status* menu, press OK on the remote.
4. Press the appropriate arrow button(s) to highlight *Resume Play* or *Play Movie* (whichever option appears). Press OK.

Note: You can also Access Movie Status Before You Play the Disc
The Divx disc must be in the disc tray and the disc tray must be closed. From the menu that appears, press the appropriate arrow buttons to highlight *View Movie Status*. Press OK.



To find out how much time is left in your viewing period, highlight *View Movie Status* and press OK on the remote.



This is the *View Movie Status* screen. To play the movie, press OK on the remote (the disc's main menu appears) Select *Resume Play* or *Play Movie*. Press OK.

DivxSilver (Purchase Unlimited Play)

Converting a Divx disc to DivxSilver allows you unrestricted, unlimited play of that disc on DVD Players registered to your Divx account.

To upgrade to DivxSilver (purchasing unlimited play):

1. Insert a Divx disc into the player and press OPEN•CLOSE. Highlight the *Purchase Unlimited Play* option on the authorization menu and press OK. (See p. 32.)

-- OR --

1. While you're playing a Divx disc, press MENU on the remote.
2. Press the appropriate arrow button(s) to highlight *Purchase Unlimited Play* and press OK. (The DivxSilver screen, showing the price your account will be billed, appears).

(continued on next page)



To convert the disc to DivxSilver, press MENU on the remote. Press the appropriate arrow buttons to highlight *Purchase Unlimited Play*. Press OK on the remote.

3. If you agree with the price to convert the disc, press OK on the remote (the terms of purchase appear on the screen).
4. If you agree with the terms, press OK (the main menu appears).
If you don't want to convert the disc at this time, use the appropriate arrow button on the remote to highlight *Cancel*. Press OK.
5. Press the appropriate arrow button(s) to highlight *Resume Play*, and press OK.

Notes:

Convert to DivxSilver at Any Time

The Divx disc must be in the disc tray and the disc tray must be closed. Press the appropriate arrow button(s) on the remote to highlight *Purchase Unlimited Play*. Press OK on the remote.

You Might Need to Enter Your Password

If you lock the player and you've set the *Divx Limits* in the DVD Player's menu to *Purchases Not Permitted*, you will have to enter your password before the player will let you purchase the Divx disc. See pp. 42-43 for more information about the *Divx Limits* menu.

DivxGold Discs

DivxGold discs can be played an unlimited number of times on any Divx-enhanced DVD Player — without charge. The availability of DivxGold discs will be determined by the motion picture studios.



If you agree to the price of the Divx disc, press OK on the remote. If you don't want to convert the disc at this time, highlight *Cancel* and press OK.

Prices Vary

The fee to convert a Divx disc to DivxSilver may vary from title to title.

Important:

If you choose to purchase unlimited play (DivxSilver), only those players registered to your account will have unrestricted viewing of the disc without additional charges.

Selecting a Chapter on a Divx Disc

A movie on a Divx disc is divided into chapters. The following instructions explain how to choose a specific chapter from the Divx disc's menu. (Other playback features are explained in the "Playing Digital Video Discs" section of this book, p. 22).

1. While you're playing a Divx disc, press MENU on the remote.
2. Press the appropriate arrow button(s) to highlight *Select Chapter*, and press the OK button.
3. Press the up and down arrow buttons on the remote to select the chapter you want to play. Use the left and right arrow buttons to go to the next set of chapters or the previous set of chapters.
4. Press OK (the movie starts playing from the chapter you selected).



The *Select Chapter* menu. Press the up or down arrow buttons on the remote to highlight a chapter and press OK. Press the left and right arrow buttons on the remote to view additional chapter selections.

All About Divx

All About Divx Mail

Divx Mail provides you with general information about your Divx account, coming attractions, and Divx retailers in your area. The telephone line cord you connected to your player enables your player to update Divx mail.

How to View a Divx Mail Message

You access Divx mail from your DVD Player's main menu.

1. To access the DVD Player's main menu, make sure the player is on and there isn't a disc playing. Press the DVD button on the remote.
2. Press the arrow down button until *Divx* is highlighted, and press OK (the Divx selections appear).
3. Press the arrow up button until *Mail* is highlighted, and press OK (the first Divx Mail menu appears—it shows the first line of each message).

There are three different icons that are used to tell you the status of each Divx mail message:



Closed Envelope = the message has not been read



Opened Envelope = the message has been read



Crumpled Envelope = the message will be erased when you exit Divx Mail

4. Use the arrow buttons to highlight the message you want to read. Press the right arrow button on the remote to highlight *Open* and press OK on the remote control (the message appears on the screen).

Sometimes a mail message is more than one page. Use the arrow up and down buttons to scroll through the mail message.

5. To exit that message, press the right arrow button (*Close* is highlighted) and press OK on the remote (the Mail Summary screen appears).

To exit Divx Mail, highlight *Exit*. Press OK.



Divx Mail icon

The front panel display on your DVD Player signals you if you have new mail (the envelope icon lights up).

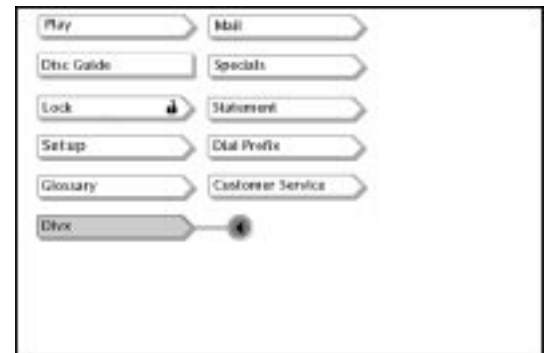

To access mail messages, highlight *Mail* in the Divx menu and press OK.



The mail summary screen shows the first line of each mail message.

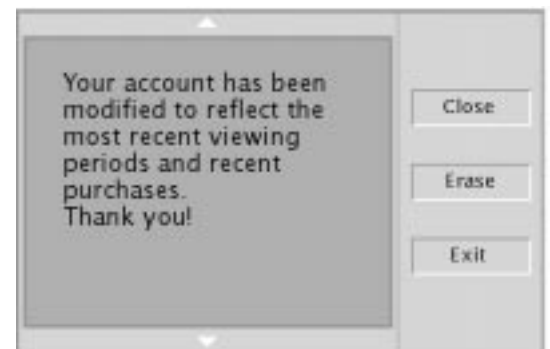

Use the arrow up and down buttons to scroll through a mail message.

How to Erase A Mail Message

There are two ways to erase a mail message:

- from the first mail menu screen (the Mail summary screen)
- when the entire message is on the screen

To erase the message from the Mail summary screen:

1. Press the arrow up or down button on the remote to highlight the message you want to erase.
2. Press the arrow right button and the arrow down button to highlight *Erase*. Press OK.
3. Highlight *Exit* and press OK to return to the previous menu.

To erase a mail message when it is on the screen:

1. Press the right arrow button to highlight *Erase*.
2. Press OK on the remote.
3. To exit Divx mail, highlight *Exit* and press OK. To return to the previous mail menu screen, highlight *Close* and press OK.

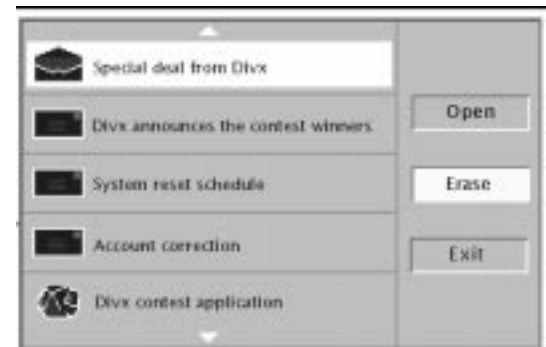

The Mail Summary Screen.

To erase a mail message, use the arrow buttons on the remote to highlight it. Highlight *Erase* and press OK on the remote control.

How to “Unerase” a Mail Message

When you choose *Erase* it automatically changes to *Unerase* in case you change your mind.

If *Unerase* isn't automatically highlighted, use the appropriate arrow buttons on the remote to highlight it and press OK (*Unerase* changes back to *Erase*).

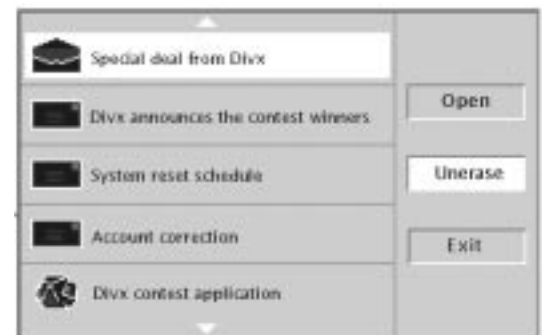

If you change your mind after you erase a message, you can select *Unerase* and press OK.

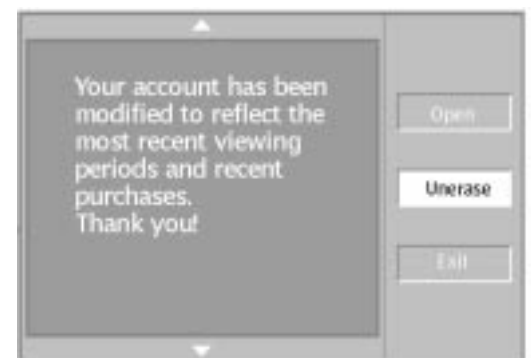

You can also erase or “unerase” a message when it is on the screen.

All About Divx

Viewing a Specials Message

Specials messages describe special promotions, special offers, maybe even contests.

1. If a disc is playing, press STOP (The DVD Player's main menu appears).
2. Press the arrow down button to highlight *Divx* and press OK (the *Divx* choices appear).
3. Press the arrow up button to highlight *Specials* and press OK (the Specials summary screen appears).
4. Use the arrow buttons to highlight the Specials message you want to read and press OK (the message appears on the screen).

A specials message might be more than one page. To see the rest of the message, use the arrow up and down buttons on the remote to scroll through the text.

5. To exit that message, press the right arrow button (*Close* is highlighted) and press OK (the Specials summary screen appears)

To exit Divx Specials, highlight *Exit*. Press OK.

Notes:

The most recent Specials messages appear at the top of the screen.

You cannot erase Specials messages. The Divx Specials messages are automatically erased when they are outdated.

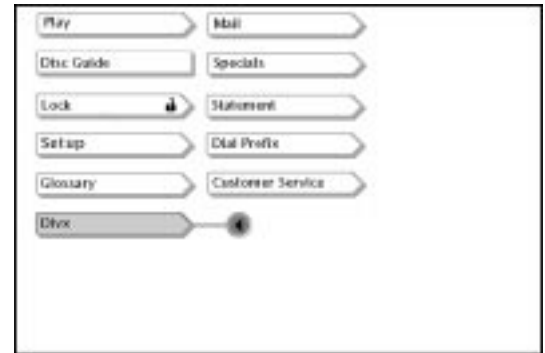

To view a Specials message, highlight *Divx* in the DVD Player's main menu. Press OK (the Divx choices appear). Highlight *Specials*, and press OK (the Specials summary screen appears).

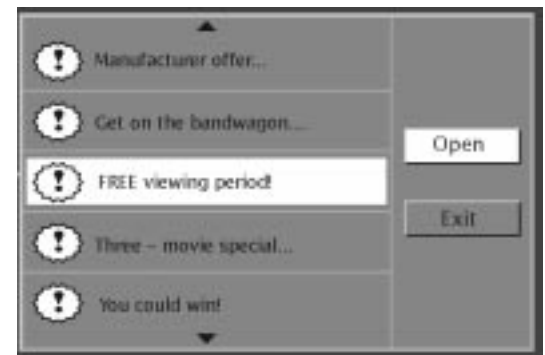

The Specials Summary Screen. To read a Specials message, use the arrow buttons on the remote to highlight one of the messages. Press the arrow right button on the remote to highlight *Open* and press OK (the message appears on the screen).

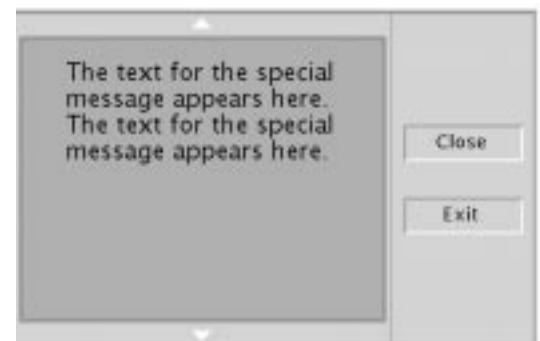

When a Specials message is on the screen, select *Close* to return to the Specials summary screen. Select *Exit* to return to the DVD Player's main menu.

Viewing Your Divx Statement

Your Electronic Statement can be viewed on your TV screen, for up to three months after the statement date. (If you prefer, you may call the Divx Customer Service Center to request a printed copy of your statement.)

To see your statement:

1. If a disc is playing, press STOP (The DVD Player's main menu appears). If you're not playing a disc, make sure the player is on and press the DVD button on the remote (the DVD Player's main menu appears).
2. Press the arrow down button to highlight *Divx* and press OK (the *Divx* selections appear).
3. Press the arrow up button to highlight *Statement*, and press OK. (The statement review screen appears showing the three most recent monthly statement dates. Listed under each statement date are the last four digits of the credit or debit card and the total charged amount.)

To see more detail, press the arrow up or down button on the remote to highlight the statement you want to see in detail. Press the right arrow button to highlight *Open* and press OK. (The statement detail screen appears. This screen lists a summary of transaction details for the monthly statement being reviewed including, details such as title, date and time of transaction, and additional charge information such as taxes and shipping, if applicable.)

You may use the Up and Down arrows to scroll through additional statement detail items if there are more than three transactions on your statement.

To exit the Statement menus, press the appropriate arrow button(s) on your remote to highlight *Close* or *Exit*, and press OK.

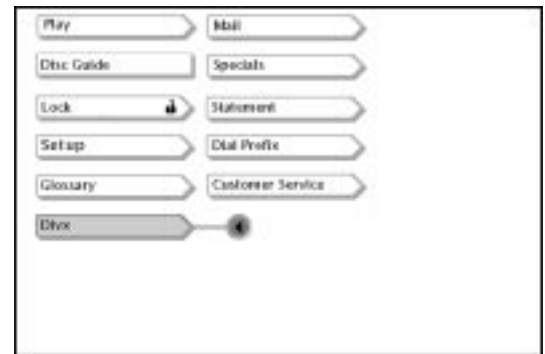

To see your Divx statement, select *Divx* from the player's main menu. From the *Divx* menu options, select *Statement*.

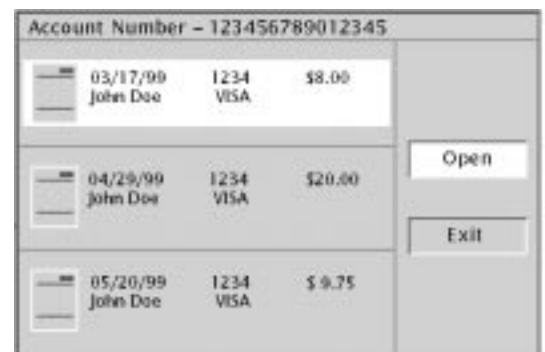

The first statement screen. Highlight an item, and choose *Open* on the menu screen to see more detail.



The second statement screen provides details of charges. Highlight *Close* and press OK on the remote to return to the first statement screen. Highlight *Exit* and press OK to exit the statement menu.

All About Divx

How to Set a Dialing Prefix

If you have to dial a special number to get an outside line, then you need to tell your Divx Player what that number is so it can communicate with Divx.

1. If a disc is playing, press STOP (The DVD Player's main menu appears). If you're not playing a disc, make sure the player is on and press the DVD button (the DVD Player's main menu appears).
2. Press the arrow down button to highlight *Divx* and press OK (the *Divx* selections appear).
3. Press the arrow up button until *Dial Prefix* is highlighted. Press OK.
4. Press the number button on the remote that corresponds to the number you have to dial on your phone to get an outside line. Press OK.
5. To return to the DVD Player's main menu, press CLEAR.

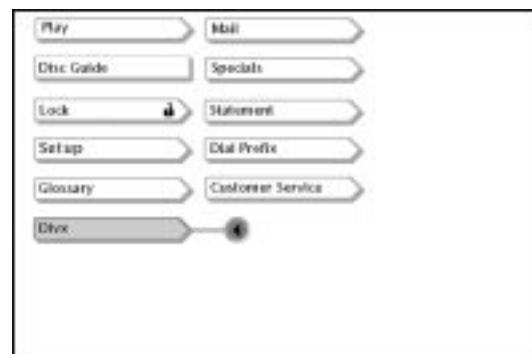

You access the *Dial Prefix* setting from the *Divx* menu.

How to Erase a Dialing Prefix

1. If a disc is playing, press STOP (The DVD Player's main menu appears). If you're not playing a disc, make sure the player is on and press the DVD button on the remote (the DVD Player's main menu appears).
2. Press the arrow down button to highlight *Divx* and press OK (the *Divx* selections appear).
3. Highlight *Dial Prefix* and press OK.
4. Press the arrow right button to highlight *No Prefix*. Press OK.
5. To return to the DVD Player's main menu, press CLEAR.

If you must dial a special number to get to an outside line, then enter that number here.

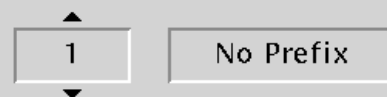

NOTE: A short pause will follow the prefix.

Enter the dial prefix with the appropriate number button on the remote. Press OK. If your phone doesn't require a dial prefix, highlight *No Prefix*.

How to Get Help (Customer Service)

Before you call Divx for help, please check the following:

- Make sure a working telephone line is connected to your DVD Player.
- Check the troubleshooting section (pages 74-77) to see if some solutions to your problem are listed there.

To access Divx Customer Service:

1. If a disc is playing, press STOP (The DVD Player's main menu appears). If you're not playing a disc, make sure the player is on and press the DVD button on the remote (the DVD Player's main menu appears).
2. Press the arrow down button to highlight *Divx* and press OK (the *Divx* selections appear).
3. Press the arrow up button until *Customer Service* is highlighted, and press OK (the Call Customer Service screen appears).

Make sure you can see the information on the screen or write it down before you call Divx (1-888-456-DIVX, which is 1-888-456-3489) because the Divx representative will ask you for the account information and player information that is on the screen.

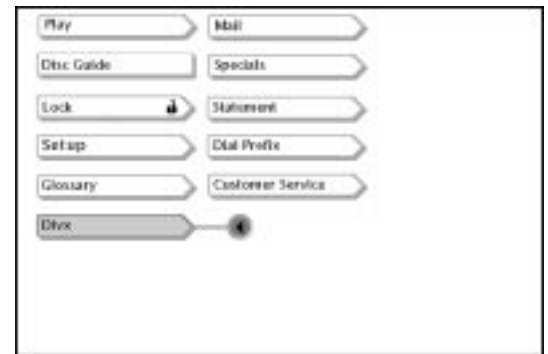

To access the Divx Customer Service screen, highlight *Customer Service* within the *Divx* menu. Press OK (the Divx number appears).

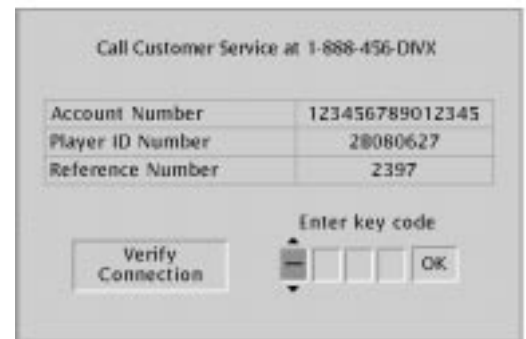

Before calling Divx (1-888-456-3489), access your Customer Service menu. Highlight *Divx* in the DVD Player's main menu. Select *Customer Service* and press OK (pertinent information the Divx representative needs to know appears on the screen).

All About Divx

How to Set Divx Limits

Divx Limits enables you to set rating limits for Divx discs, restrict purchases of Divx discs (*DivxSilver*), and restrict purchases of additional viewing periods (*Rentals*). All of the settings for Divx Limits are in the *Lock* section of the DVD Player's main menu.

Your DVD Player must be locked in order for the Divx Limits to be enforced. See page 50 for instructions on locking your player.

To Set Rating Limits

1. If a disc is playing, press STOP (the DVD Player's main menu appears). If you're not playing a disc, make sure the player is on and press the DVD button on the remote (the DVD Player's main menu appears).
2. Press the arrow down button until *Lock* is highlighted. Press OK.
3. Press the arrow down button until *Divx Limits* is highlighted.
4. Press OK (the Ratings, Rentals, and Purchases menu appears).
5. Press the arrow up button until *Ratings* is highlighted.
6. Press OK (the *Ratings* menu items appear)
7. To change the rating limit, highlight *MPAA* (Motion Picture Association of America) and press OK (the rating limit screen appears).
8. Press the arrow up or down button on the remote control to change the rating limit. When the rating appears in the green area, all Divx discs with that rating can be played in the player without a password. This is called *Free Access*.
9. If a movie is rated with a rating that appears in the *Password Required* part of the ratings block, your DVD Player will require you to enter your password before you play the movie.

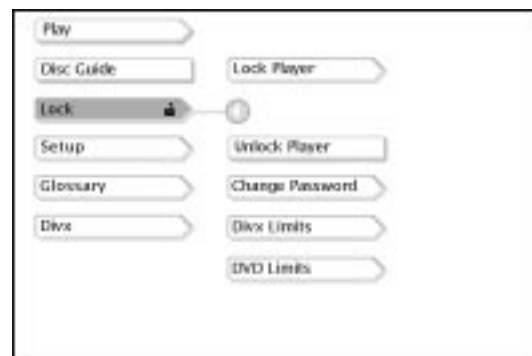

To adjust the settings in the *Divx Limits* menu, highlight the *Lock* menu and press OK on your remote. Highlight *Divx Limits* and press OK.



To adjust the ratings limit, highlight *Ratings* within the *Divx Limits* menu and press OK on the remote. The ratings block appears.



Use the up and down arrow buttons on your remote to change the rating limit level. The ratings that appear in the *Free Access* part of the ratings block do not require a password. The ratings in the *Password Required* part of the block will require a password.

To Restrict Rentals

You can purchase an additional viewing period after you've used your initial viewing period. To restrict purchases, you can set your player to require a password before an additional viewing period can be purchased.

1. If a disc is playing, press STOP (the DVD Player's main menu appears). If you're not playing a disc, make sure the player is on and press the DVD button on the remote (the DVD Player's main menu appears).
2. Press the arrow down button on the remote until *Lock* is highlighted and press OK.
3. Press the arrow down button until *Divx Limits* is highlighted and press the OK button.
4. Press the arrow up button until *Rentals* is highlighted.
5. Press OK to change the setting from *Permitted* to *Not Permitted* and vice versa.

To go back to the DVD Player's main menu, press CLEAR on the remote.

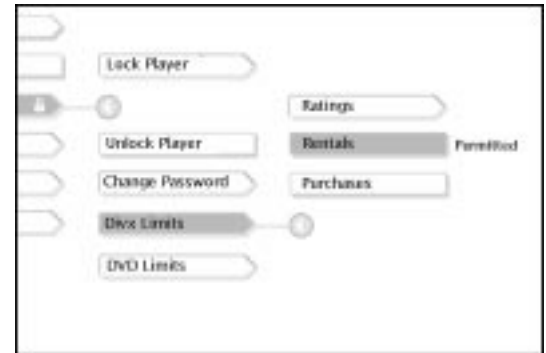

To adjust the requirement for purchasing additional viewing periods, highlight *Rentals* within the *Divx Limits* menu and press OK on your remote. Each time you press OK, the setting changes from *Permitted* to *Not Permitted* and vice versa.

To Restrict Purchases

You can convert a Divx disc to DivxSilver at any time. DivxSilver allows you unrestricted, unlimited play of that disc on any player with your account information.

You can set your player to require a password before anybody can convert a disc to DivxSilver.

1. If a disc is playing, press STOP (the DVD Player's main menu appears). If you're not playing a disc, make sure the player is on and press the DVD button on the remote (the DVD Player's main menu appears).
2. Press the arrow down button on the remote until *Lock* is highlighted. Press the OK button.
3. Press the arrow down button until *Divx Limits* is highlighted and press OK.
4. Press the arrow up button until *Purchases* is highlighted.
5. Press OK to change the setting from *Permitted* to *Not Permitted* and vice versa.

To go back to the DVD Player's main menu, press CLEAR on the remote.

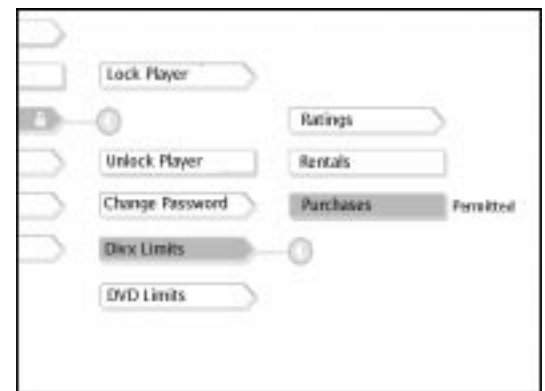

To adjust the requirement for purchasing a Divx disc (converting it to DivxSilver), highlight *Purchases* within the *Divx Limits* menu and press OK on your remote. Each time you press OK, the setting changes from *Permitted* to *Not Permitted* and vice versa.

Important Account Information

If you move or change your phone number

If you move to another residence or change phone numbers, please call Divx at 1-888-456-DIVX (1-888-456-3489) so your account information can be updated properly.

If you dispose of your player

If you dispose of your player (i.e., sell it or give it away), it is imperative that you disconnect from Divx properly to ensure that you are not billed for Divx services that were incurred by somebody else. Call Divx at 1-888-456-DIVX (1-888-456-3489). The Divx representative will tell you how to properly disconnect your player.

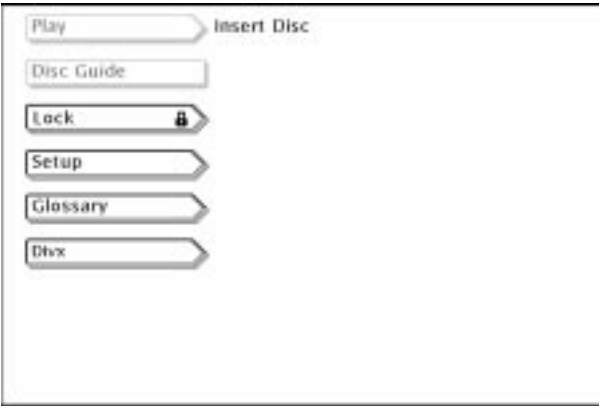

Using the Features in the Menu System

Putting You In Control

This section describes other features and settings that are accessed in your DVD Player's main menu. This menu system lets you customize your DVD player — set up rating limits, choose various language preferences, change the TV image setting, and more!

I've written specific steps for each menu item, but you can also play around with the menus by following a couple of navigational rules that are described on the next page.

Section Overview

- Let's Talk About Navigation
- Play Menu
- Disc Guide Menu
- Lock Menu
- Setup Menu
- Glossary
- Divx Menu (this menu is described in "All About Divx" page 36.)

Using the Features in the Menu System

Let's Talk About Navigation

How to use your Remote to Move through the Player's Menu System

We use the term "highlighted" repeatedly when explaining how to move through the menus.

Highlighted means that a particular item stands out from the other items on the screen. In your DVD Player's menu system, a highlighted item appears brighter than the other options on the screen.

Here's how you navigate:

- Use the arrow buttons (up, down, right, and left) to highlight different items in the menu system.
- Press OK to choose an item that you've highlighted.
- Press GO BACK on the remote to return to the previous set of menu items. (Or you can press the left arrow button to go back to the previous menu if it seems faster to you.)
- Press CLEAR to return to the main menu: the first set of menu screens.

Two types of menus: path and static

Path Menu Item

A path item is denoted with an arrow to let you know this option is a path to MORE options. To see the path menu options, highlight the path menu and press OK (the next set of menu items appears).

The *Play* menu is an example of a path menu— when the *Play* menu is highlighted, press OK (the Play options appear on the screen).

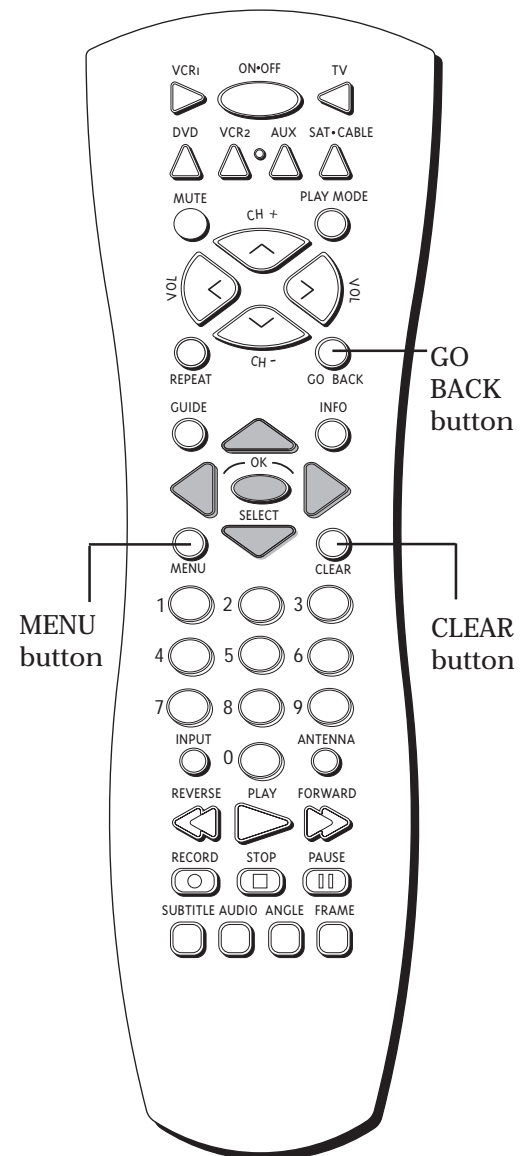

The buttons used for navigation are shown in gray (the OK button, and the up, down, left and right arrow buttons). Press MENU to see the DVD Player's main menu.

Using the Features in the Menu System

Static Menu Item

Static menu items are used in two ways:

With a static menu item, what you see is what you get. When a static menu is highlighted, press OK and that action is taken. *Disc Guide* on your player's menu system is an example of a static menu item. Press OK when *Disc Guide* is highlighted, the disc guide (the disc's menu) appears.

Sometimes a static menu is used as a "toggle." You highlight the static menu, press OK, and the selection changes from one choice to another. *AutoPlay* within the *Setup* menu is an example of a static menu item that is a toggle. Highlight *AutoPlay*, and press OK (the selection changes from *On* to *Off* and vice versa, each time you press OK).

Additional Menu Information

Menu item is "grayed out" — this item isn't available (i.e., *Play* and *Disc Guide* appear "grayed out" if you haven't put a disc in the player).



This is called, the "Go Back" icon — when it is highlighted, press OK to return to the previous menu.

Notes:

You must make sure the remote is in DVD mode (press the DVD button on the remote control) in order to move through the Player's menu. This is a frequent solution to consumer problems, according to our Consumer Relations department.

Throughout the menu, the text at the bottom of the screen gives you instructions on how to perform a task.

Since your TV is color and this book isn't, we've adjusted the appearance of the menus for better readability.

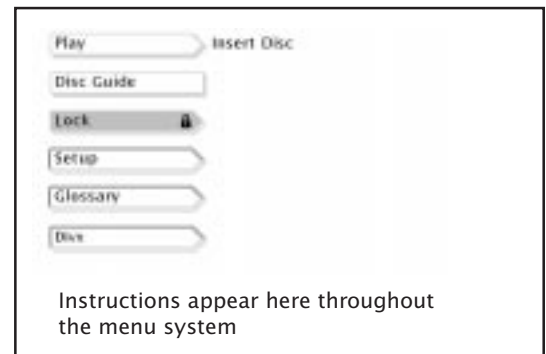

The *Play* menu and *Disc Guide* appear "grayed out" because those menus aren't available since there isn't a disc in the player.

Using the Features in the Menu System

The Play Menu Options

The DVD Player's *Play* menu enables you to choose different ways to play the disc. To see the *Play* menu options, a disc must be in the DVD player.

1. Make sure your remote is in DVD mode (press the DVD button).
2. If the disc is playing, press STOP (the DVD Player's main menu appears).
3. If the *Play* path item isn't highlighted, press the up arrow button to highlight it.
4. Press OK (the *Play* menu items appear).

Standard Play: plays the discs titles and chapters in their default order (i.e., chapter 1 of Title 1 plays first, then chapter 2 of Title 1, etc.)

Random Play: plays the chapters of each title in random order.

Program Play: you program your player to play the chapters on the disc in the order you choose (you must select *Edit Program* and set up the order in which you want the chapter(s) and title(s) on the disc to play).

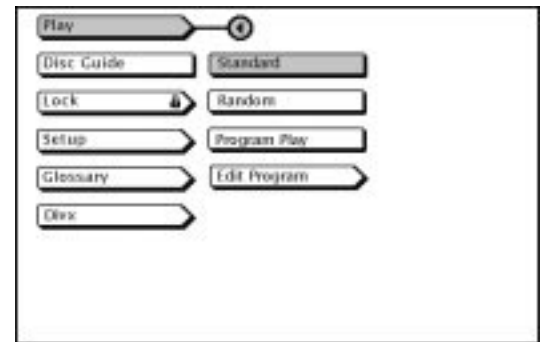

To access the *Play* menu options, highlight *Play* and press OK.

How to Create a Program:

1. After selecting the *Play* menu, press the arrow down button until *Edit Program* is highlighted.
2. Press OK (the Playlist menu appears).
3. Press the number buttons on the remote to choose the title (the cursor goes to the *Chapter* section). If there is only one title on the disc, you have to press the arrow right button to highlight the *Chapter* section.
4. Press the number buttons to choose the chapter (use two digits, i.e., press 05 instead of 5 for chapter 5). *Add* is automatically highlighted.
5. Press OK to add the title and chapter you entered as the first item on your *Playlist* (your entry appears in the *Playlist* area).
6. Repeat steps 1-3 to enter additional title/chapter selections.
7. When you've entered all of the title/chapter selections that you want to include in your playlist, press the appropriate arrow button(s) to highlight *Done*. Press OK (the *Play* options menu appears).

Note:

If you want to play the disc in the order you just programmed, press the appropriate arrow button(s) on the remote to highlight *Play* and press OK.

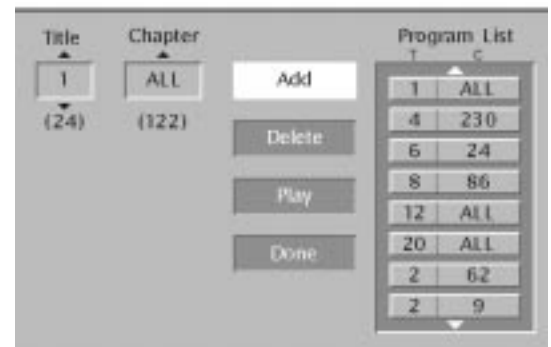

To create a program, highlight *Play* and press OK. Highlight *Edit Program* and press OK (the playlist appears). Enter the title and chapters and select *Done* when you're finished.

Using the Features in the Menu System

How to Delete or Edit a Program:

1. After selecting the *Play* menu, press the arrow down button until *Edit Program* is highlighted.
2. Press OK (the Playlist menu appears). Press the appropriate arrow buttons to highlight the entry in the playlist that you want to delete. Press OK.
3. Press the appropriate arrow button to highlight *Delete*.
4. Press OK (the playlist item that is highlighted is deleted).
5. Continue deleting playlist items as explained above. When you're finished, press the appropriate arrow button on the remote to highlight *Done*. Press OK.

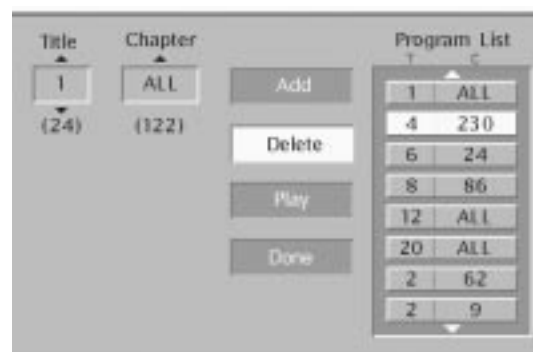

To edit a program, highlight the playlist from the *Edit Program* menu. Use the arrow buttons to highlight an item in the playlist. Select the item by pressing OK. Highlight *Delete* and press OK to delete that item.

Disc Guide

The DVD Player's Disc Guide menu enables you to access the disc's guide from the DVD Player's main menu. A disc guide lists all of the titles on the disc, but some discs don't have a disc guide. To access the disc's guide, make sure a disc is in the DVD player.

1. Make sure your remote is in DVD mode (press the DVD button).
2. If the disc is playing, press STOP (the DVD Player's main menu appears).
3. Press the arrow down button until *Disc Guide* is highlighted.
4. Press OK (the disc's menu appears)
5. To return to the DVD Player's menu when the disc menu is on the screen, press STOP on the remote.

Notes:

The Disc Guide isn't the same as the disc menu (or the menu for the movie that's on the disc.) You access the menu for the movie you're playing by pressing MENU on the remote when you're playing the movie.

Not all discs have a disc guide.

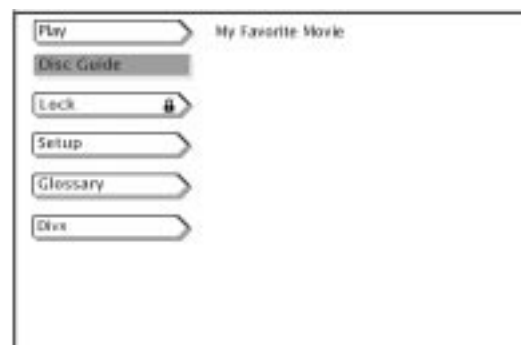



You can access the disc's guide from the player's main menu. Highlight *Disc Guide* and press OK.

Using the Features in the Menu System

How to Use the Lock Menu

The padlock icon tells you whether your player is locked or unlocked.

 **Locked:** A password is needed in order to play discs that aren't included in the rating limits you have set. Nobody can access the Lock Menu items (*Unlock Player*, *Change Password*, etc.) without entering the password.

 **Unlocked:** A password isn't required to play discs.

To Lock your DVD Player:

1. Make sure your remote is in DVD mode (press the DVD button).
2. If the disc is playing, press STOP (the DVD Player's main menu appears).
3. Press the arrow down button until *Lock* is highlighted.
4. Press OK (the *Lock* menu items appear).
5. Press the arrow up button to highlight *Lock Player*.
6. Press OK (*Enter New Password* screen appears).
7. Press the number keys on the remote to enter the password you want to use (similar to entering your PIN when you use a bank machine).
8. After you've entered the last number in the password, press OK (*Confirm Password* appears).
9. Enter the numbers you entered the first time and press OK when you're finished (the previous menu appears).

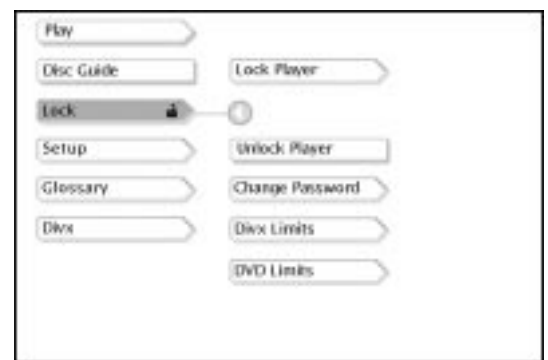

To lock your DVD player, highlight *Lock* and press OK on the remote. Highlight *Lock Player* and press OK.

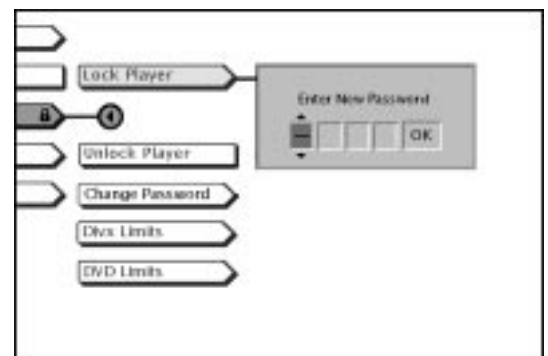

When you select *Lock Player*, you must enter the password you want to use. Use the number buttons on the remote control to enter your password numbers and press OK.

The Disc Tray is Locked

If the message "*Tray Locked*" appears on the screen, the retail lock feature has been accidentally engaged. To unlock the disc tray you must press and hold a combination of keys simultaneously:

On the front panel of the DVD Player, press and hold the STOP, ON•OFF and OPEN/CLOSE buttons for at least 3 seconds.

Using the Features in the Menu System

To Unlock the Player:

1. Make sure your remote is in DVD mode (press the DVD button).
2. If the disc is playing, press STOP (the DVD Player's main menu appears).
3. Press the arrow down button until *Lock* is highlighted.
4. Press OK (*Enter Password* appears on the screen).
5. Enter your password and press OK.
4. Use the arrow button to highlight *Unlock Player* and press OK (the lock icon appears unlocked).

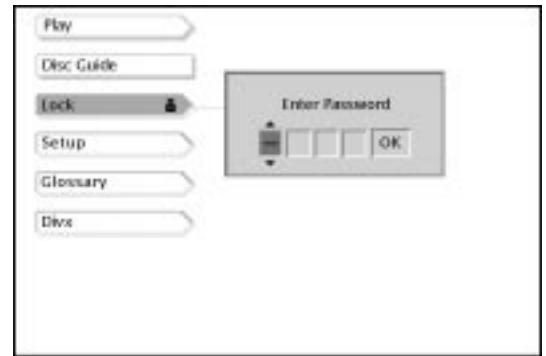

To unlock the player: highlight *Lock*, press OK on the remote, and enter your password (the *Lock* menu items appear).

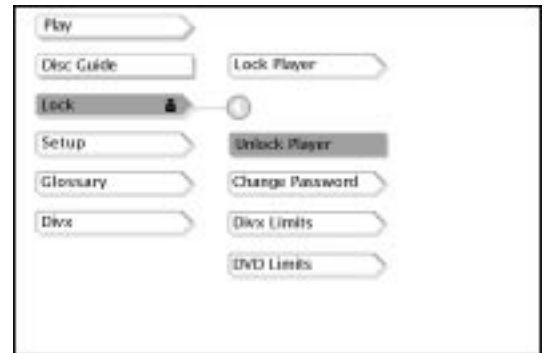

Highlight *Unlock* and press OK to finish unlocking the player.

How to Change Your Password

The player must be locked to change the password.

1. Make sure your remote is in DVD mode (press the DVD button).
2. If the disc is playing, press STOP (the DVD Player's main menu appears).
3. Press the arrow down button until *Lock* is highlighted.
4. Press OK (*Enter Password* appears on the screen). Enter your password.
5. Press the arrow button to highlight *Change Password*, and press OK. (*Enter New Password* appears.)
6. Press the number buttons on the remote to enter the new password you want to use and press OK (*Confirm Password* appears).
7. Press the number keys to enter the password again and press OK when you're finished.

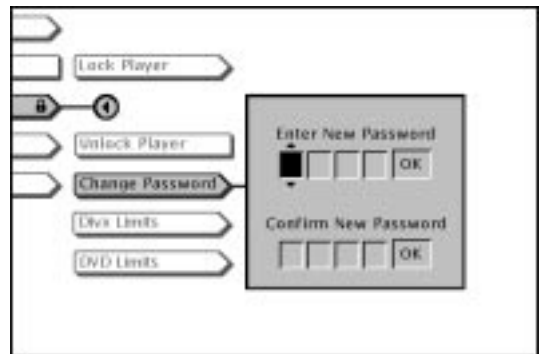

The player must be locked to change your password. Highlight *Lock* and press OK on the remote. Enter your password. Highlight *Change Password* and press OK. Enter your new password.

Using the Features in the Menu System

How to Set Divx Limits

All of the Divx features are explained in the section called “All About Divx.” How to set Divx Limits is on page 42.

Setting the Rating Limit

The DVD Limits feature is a rating limit system. It works in conjunction with DVDs that have been assigned a rating—which helps you control the types of DVDs that your family watches.

How to Set DVD Limits

1. Make sure your remote is in DVD mode (press the DVD button).
2. If the disc is playing, press STOP (the DVD Player's main menu appears).
3. Press the arrow down button until *Lock Player* is highlighted. Press OK (the *Lock* selections appear).
4. Press the arrow down button until *DVD Limits* is highlighted, and press OK (the DVD rating limits information appears).

Country: Some countries use different rating systems

1. To change the country, press the arrow right button to highlight *Country*.
2. Press OK (a list of countries appears).
3. Use the arrow up and down button on the remote to highlight the country that applies to you. Press OK (the country you selected appears next to the *Country* path menu).
4. Press CLEAR to return to the main menu or press GO BACK to return to the previous menu screen.

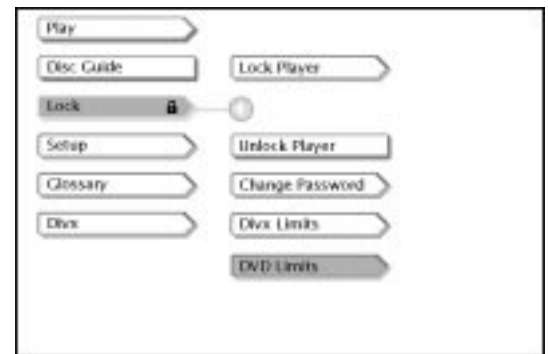

To access the *DVD Limits* settings, highlight *Lock* and press OK. Highlight *DVD Limits* and press OK.



You can change the settings for all of the *DVD Limits* menu items: Country, Rated Titles, and Unrated Titles.



Different countries use different ratings systems. To access the list of countries, highlight *Country* and press OK.

Using the Features in the Menu System

Rated Titles

This part of *DVD Limits* lets you determine how your player will react to discs that contain movies that are rated (in the U.S.A. the Motion Pictures Association of America rates movies as G, PG, PG-13, etc.)

You decide which ratings require a password and which ones don't. This system ranks the ratings 1 through 8 in order to accommodate different countries' ratings systems (1 is considered a movie title with the least offensive material).

1. Highlight *DVD Limits* within the *Lock* menu, and press OK.
2. Press the arrow right and arrow down buttons to highlight *Rated Titles* and press OK (the 8-level grid with rating limits appears).
3. To change the rating limit, press the arrow up or arrow down button.
 - The ratings that don't require a password (free access) appear in the green part of the block.
 - The ratings that require a password appear in the red part of the block.
4. Press OK (the rating limit appears next to the *Rated Titles* path menu).
5. Press CLEAR to return to the main menu or press GO BACK to return to the previous menu screen.

Example: If you set PG as the highest rating for Free Access (green), then the *Rated Titles* selection appears as 3 (that's the player's number for PG in its 8-level system) and PG for the movie studios rating. This means when the player is locked, it will require you to enter the password to play any discs that are rated higher than PG (i.e., PG13 or R).

Note: If the Rating Limit Feature Doesn't Work

In order for the Rating level feature to work, the disc must be encoded with the proper rating information. If the author of the disc did not encode rating information, then this feature will not work for that disc.

The DVD Player must be locked in order for it to enforce the settings in the *DVD Limits* part of the *Lock* menu.

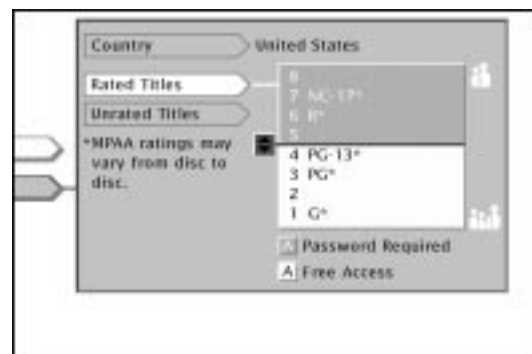

Some titles (movies) are rated and some are not rated. To set the rating limit for rated movies, highlight *Rated Titles* and press OK. Use the up and down arrow keys to the rating level.

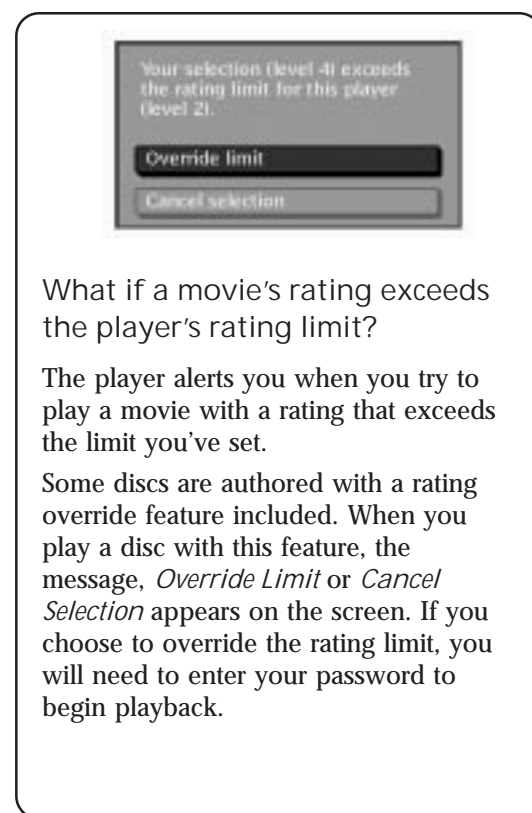

What if a movie's rating exceeds the player's rating limit?

The player alerts you when you try to play a movie with a rating that exceeds the limit you've set.

Some discs are authored with a rating override feature included. When you play a disc with this feature, the message, *Override Limit* or *Cancel Selection* appears on the screen. If you choose to override the rating limit, you will need to enter your password to begin playback.

Using the Features in the Menu System

Unrated Titles:

Some Titles (movies) aren't rated. You decide how you want the *DVD Limits* feature of your player to handle these discs: free access or password required.

To choose the *Unrated Titles* options:

1. Highlight *DVD Limits* within the *Lock* menu, and press OK.
2. Press the arrow down button until *Unrated Titles* is highlighted.
3. Press OK (the *Unrated Titles* options appear).
4. Use the arrow up or down button to highlight your choice: Free Access or Password Required. Press OK (the *Unrated Titles* path, with the choice you made, appears).
5. Press CLEAR to return to the main menu or press GO BACK to return to the previous menu screen.



To change the way your player reacts to unrated movies, highlight *Unrated Titles* within the *DVD Limits* menu. Press OK on the remote. Use the up and down arrow buttons to highlight a selection and press OK.

Using the Setup Menu

Setup contains many options for your DVD Player: language preferences for audio, subtitles, and menus; whether or not you want a disc to play automatically when you put it in the player; the TV image; the Sound setting, the lighting of the front panel display. This section explains each option from top to bottom.

To see the *Setup* items:

1. From the DVD Player's main menu (player ON, no disc playing), press the arrow down button until *Setup* is highlighted.
2. Press OK (the *Setup* selections appear).

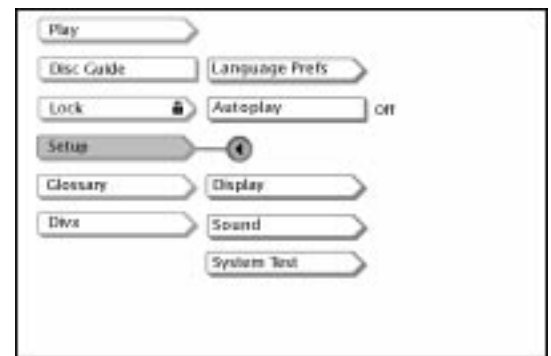

To see the *Setup* menu options, highlight *Setup* in the DVD Player's main menu and press OK.

Language Prefs (preferences)

The *Language Prefs* (preferences) menu enables you to choose different language options for the audio, subtitles, and the player's menu items.

1. Select the *Setup* menu within the DVD Player's main menu.
2. Press the arrow up button until *Language Prefs* is highlighted, and press OK (the language options appear).

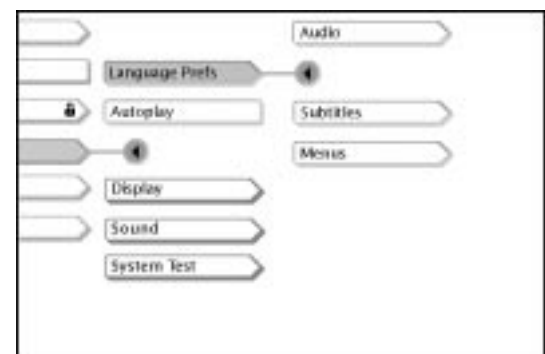

The *Lang Prefs.* menu enables you to choose different language options for the sound, subtitles, and menu items.

Using the Features in the Menu System

Changing the Audio Language Preference

The Audio Language menu enables you to choose which language you want the discs to use.

1. From the *Language Prefs* menu (within the *Setup* menu), press the arrow up button to highlight *Audio*.
2. Press OK (the audio language options appear).
3. Press the arrow up or down button until the language you want to use for the audio portion of each title is highlighted.
4. Press OK (the previous menu appears with your selection shown next to the *Audio* path menu).
5. Press CLEAR to return to the main menu or press GO BACK to return to the previous menu screen.

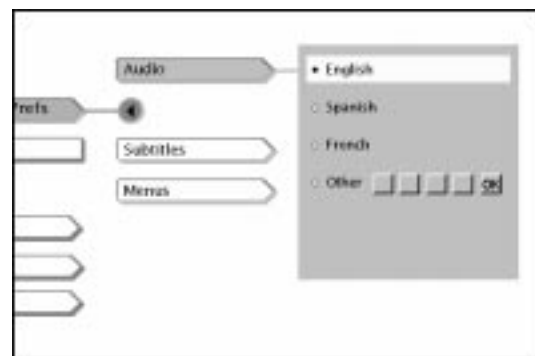

To change the language of the title's audio, select *Audio Language* from the *Lang Prefs* menu. Use the arrow up and down buttons on the remote to choose a language, and press OK.

How to Set *Other* as an Audio Language Option

If the language you want to use isn't listed, select *Other*.

1. Press the arrow down button to highlight *Other*. Press OK.
2. Enter the code from the Language Codes list on p. 62.
3. Press OK (the previous menu appears with your selection shown next to the *Audio* path menu).
4. Press CLEAR to return to the main menu or press GO BACK to return to the previous menu screen.

NOTE:

Remember, your player can't play the disc in the language you have chosen if the disc wasn't created with that language option.

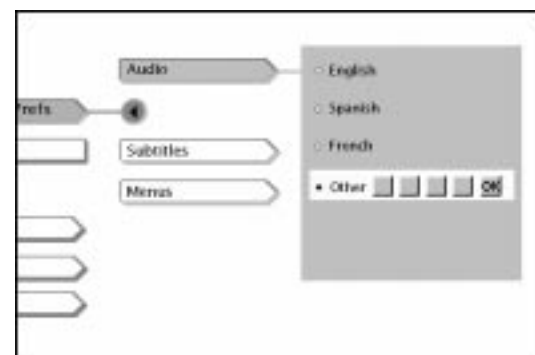

You must enter a code to enter an audio language that isn't listed. Enter the appropriate code from the Language Codes list on p. 62.

Using the Features in the Menu System

Changing the Subtitle Language Preference

The *Subtitles* menu enables you to choose the language of the subtitles.

1. From the *Language Prefs* menu (within the *Setup* menu), press the arrow down button to highlight *Subtitles*.
2. Press OK (the subtitle options appear).
3. Press the arrow up or down button until the language you want to use for the subtitles of each title is highlighted.
4. Press OK (the previous menu appears with your selection shown next to the *Subtitles* path menu).
5. Press CLEAR to return to the main menu or press GO BACK to return to the previous menu screen.

Note:

Remember, your player can't play the disc in the language you have chosen if the disc wasn't created with that language option.

How to Set *Other* as a Subtitle Language Option

If the language you want to use isn't listed, select *Other*.

1. Press the arrow down button to highlight *Other*. Press OK.
2. Enter the code from the Language Codes list on p. 62.
3. Press OK (the previous menu appears with your selection shown next to the *Subtitles* path menu).
4. Press CLEAR to return to the main menu or press GO BACK to return to the previous menu screen.

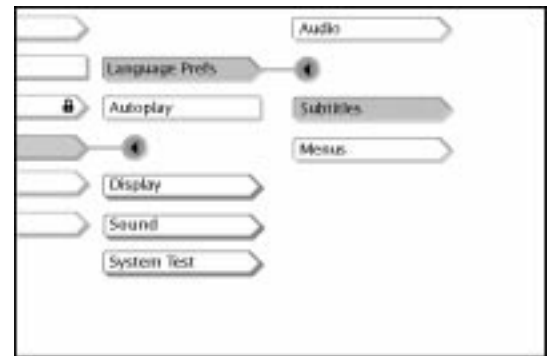

To change the *Subtitles* setting, highlight *Subtitle* and press OK on the remote. Use the up and/or down arrow button(s) to highlight the language you want to use. Press OK.

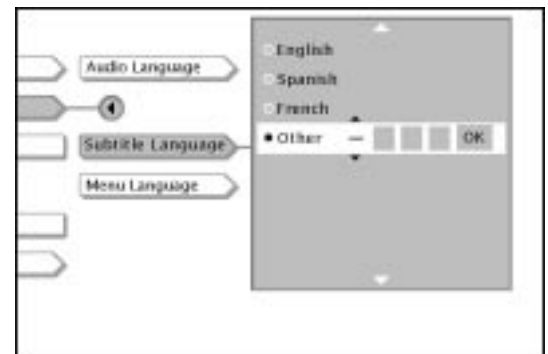

To choose another language, highlight *Other* and enter the code from page 62.

Using the Features in the Menu System

Changing the Menu Language

You can choose one of three languages for the text that appears within the on-screen menu system.

1. From the *Language Prefs* menu (within the *Setup* menu), press the arrow down button until *Menu* is highlighted.
2. Press OK (the language choices for the DVD Player's menu appear).
3. Press the arrow up or down button until the language you want to use for the menu items is highlighted.
4. Press OK (the previous menu appears with your selection shown next to the *Menu* path menu).
5. Press CLEAR to return to the main menu or press GO BACK to return to the previous menu screen.

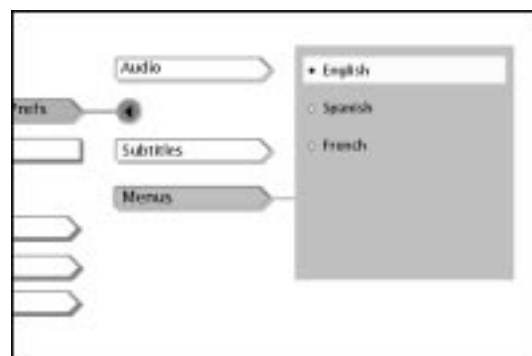

To change the language used in the menu system, highlight *Menu* and press OK on the remote. Use the up and/or down arrow button(s) to highlight the language you want to use. Press OK.

AutoPlay

You can set the *AutoPlay* menu to play your disc automatically after you close the disc tray.

1. From the DVD Player's main menu (player ON, no disc playing), press the arrow down button until *Setup* is highlighted. Press OK (the *Setup* selections appear).
2. Press the arrow up button to highlight *AutoPlay* (the current setting appears next to the *AutoPlay* static menu item).
3. Press OK to change the setting from *Off* to *On* and vice versa.
4. Press CLEAR to return to the main menu or press GO BACK to return to the previous menu screen.

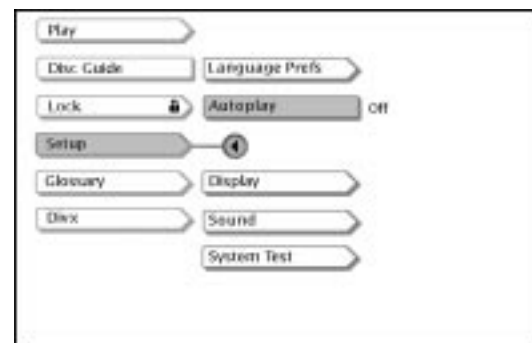

If you want discs to start playing automatically when you close the disc tray, set *AutoPlay* to *On*.

Using the Features in the Menu System

Display

The display menu contains the settings for your TV and the illumination of the front panel.

TV Image

The *TV Image* menu adjusts the way a movie appears on your TV. Standard TVs are 4 x 3 format. Depending on the type of television you have, you may want to adjust the screen setting (also called, the aspect ratio).

1. From the DVD Player's main menu (player ON, no disc playing), press the arrow down button until *Setup* is highlighted. Press OK (the *Setup* selections appear).
2. Press the arrow down button to highlight *TV Image*. Press OK (the *TV Image* options appear).

- *4 x 3 Letterbox*: Choose this setting if you would prefer to see movies in their original aspect ratio. You will see the entire frame of the movie, but it will occupy a smaller portion of the screen. This setting may result in the movie appearing with black bars at the top and bottom of the screen.
- *4 x 3 Standard*: Choose this setting if you want the movie to fill the entire screen of your TV. You won't see part of the picture (particularly the right and left edges).

Some discs produced in a widescreen format can't be cropped in this fashion, which means the black bars would appear at the top and the bottom of the screen.

- *16 x 9 Widescreen*: Choose this setting if your DVD Player is connected to a widescreen TV.

If you choose this setting and you don't have a widescreen TV, the images on the screen may appear distorted due to vertical compression.

Note:

If you play a disc recorded in 4 x 3 format on a widescreen TV, the left and right side of the screen will appear black.

Front Display

This feature enables you to choose how the front panel display on your DVD Player appears.

1. From the DVD Player's main menu (player ON, no disc playing), press the arrow down button until *Setup* is highlighted. Press OK (the *Setup* selections appear).
2. Press the arrow down button until *Display* is highlighted. Press OK (the *Display* options appear).
3. Press the arrow down button to highlight *Front Display*. Press OK.

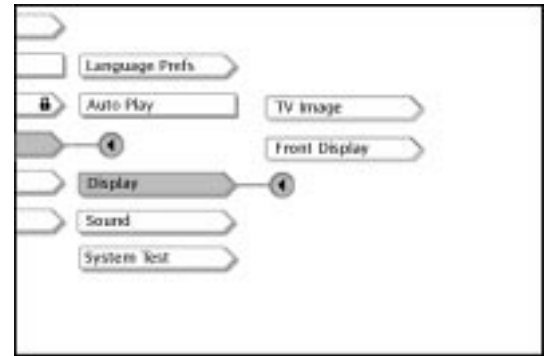

The Display menu contains setting for the TV screen and the front panel display.

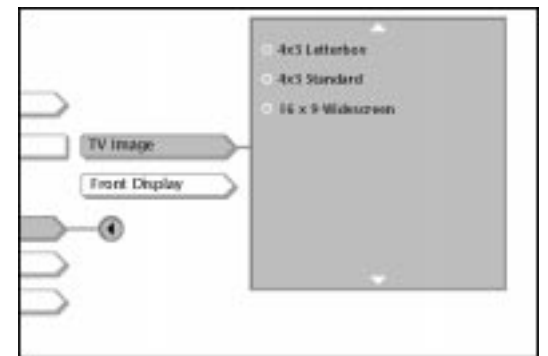

To change the *TV Image*, highlight *TV Image* and press OK on the remote. Use the up and/or down arrow buttons to highlight a setting and press OK.



You can change the lighting on the front panel of your player by adjusting the *Front Display* menu setting.

Using the Features in the Menu System

4. Press the arrow up and down buttons to highlight the setting you want to use.
5. Press OK (the previous menu appears with your selection next to the *Front Display* path menu).
6. Press CLEAR to return to the main menu or press GO BACK to return to the previous menu screen.

Note: When you set *Front Display* to *Auto*, the display is dim when the player is off and bright when the player is on.

Sound

The *Sound* menu lets you select different sound settings depending on the equipment you have connected to your DVD Player.

1. From the DVD Player's main menu (player ON, no disc playing), press the arrow down button until *Setup* is highlighted. Press OK (the *Setup* selections appear).
2. Press the arrow down button until *Sound* is highlighted. Press OK (the *Sound Logic* menu and the *Audio Equipment* menu appear on the screen).

Sound Logic

Sound Logic compresses the dynamic range (quietest sound to loudest sound) of a disc's soundtrack. This feature is useful for late-night listening when you want to hear a movie's dialogue without having to turn up the volume.

1. Press the arrow up button until *Sound Logic* is highlighted, and press OK (the *Sound Logic* options appear).
2. Press the arrow up or down buttons to highlight your selection.
 - *Off-No Compression*: the disc's soundtrack plays exactly as it was authored.
 - *Low Compression*: Compresses the range of sound the least amount.
 - *Medium Compression*: Compresses the range of sound a little more than Low Compression
 - *High Compression*: lends the least amount of sound variance.
3. Press OK after you highlight the option you want to use (the previous screen, with your selection listed, appears)
4. Press CLEAR to return to the main menu or press GO BACK to return to the previous menu screen.

Note:

The performance of the *Sound Logic* feature varies depending on the type of equipment you have connected to your DVD Player and the audio format of the disc you're playing.

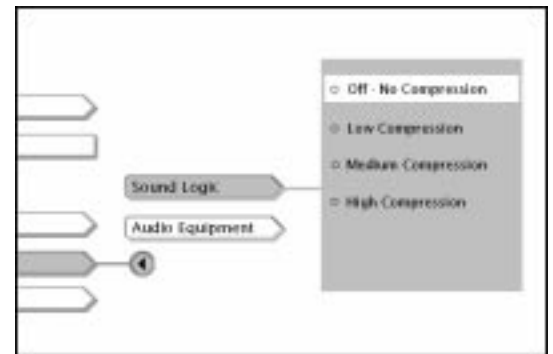

The *Sound* menu contains the *Sound Logic* feature and *Audio Equipment* settings.

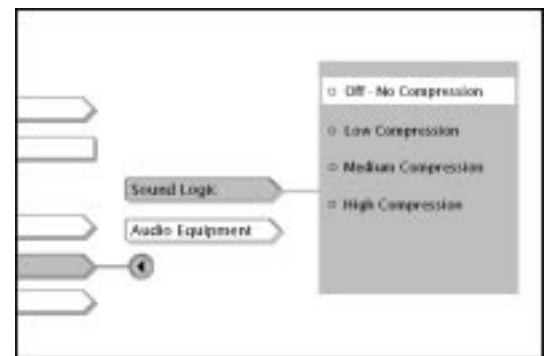

To change the *Sound Logic* setting, highlight *Sound Logic* and press OK on the remote. Use the up and down arrow buttons to change the setting and press OK.

Using the Features in the Menu System

Audio Equipment

If you've connected a Dolby Pro Logic, Dolby Digital, or DTS receiver, you must adjust this setting.

1. From the DVD Player's main menu (player ON, no disc playing), press the arrow down button until *Setup* is highlighted. Press OK (the *Setup* selections appear).
2. Press the arrow down button until *Sound* is highlighted. Press OK (the *Sound Logic* menu and the *Audio Equipment* menu appear on the screen).
3. Press the arrow up button to highlight *Audio Equipment*, and press OK (the *Audio Equipment* options appear).
4. Use the arrow up or down button to highlight the appropriate selection:
 - *PCM*: choose this setting for all connection scenarios, except the Dolby Digital or DTS receiver or decoder connection.
 - *Dolby Digital*: choose this setting if you connected a Dolby Digital receiver or decoder to your DVD Player.
 - *DTS*: choose this setting if you connected a DTS receiver or decoder to your DVD Player.
5. Press OK after you choose your setting (the previous menu appears with your selection shown next to Digital Output).
6. Press CLEAR to return to the main menu or press GO BACK to return to the previous menu screen.

Note:

You'll find definitions for PCM, DTS, and Dolby Digital in your DVD Player's on-screen glossary. See the Glossary section on the next page for directions.

The System Test

The System Test displays information about your DVD Player. The Divx or RCA representative may ask you to access this information if you're having trouble with your DVD Player.

1. If a disc is playing, press STOP (the DVD Player's main menu appears). If you're *not* playing a disc, make sure the player is on, the drawer is closed, and press the DVD button on the remote (the DVD Player's main menu appears).
2. Press arrow down button to highlight *Setup* and press OK (the *Setup* selections appear).
3. Press the arrow down button on your remote to highlight *System Test* and press OK (the System Test information appears).

Note:

The System Test is a diagnostic tool for customer service representatives and doesn't necessarily indicate a problem with your DVD Player.

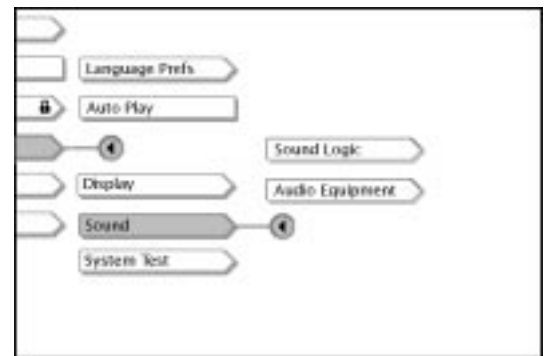

If you inserted an optical digital cable to the DIGITAL AUDIO OUT jack on the back of your player, you must set the *Audio Equipment* setting to *Dolby Digital* or *DTS* to match the brand of receiver you've connected to the DVD Player.

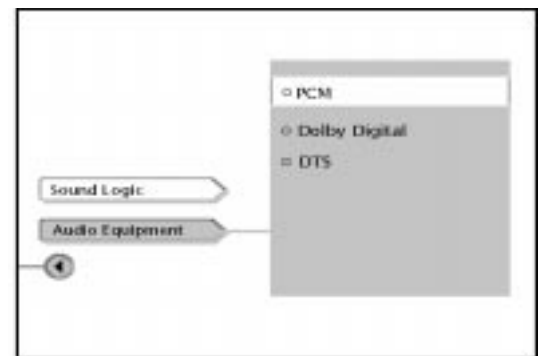

To change the Audio Equipment setting, highlight *Audio Equipment* and press OK on the remote. Highlight the appropriate setting and press OK.

Important: DTS Information

If you set the *Audio Equipment* menu to *DTS*, you must have your DVD Player connected to a receiver or decoder with the DTS feature and the disc you play must support the DTS audio format. If you choose DTS and your receiver, decoder, or disc doesn't support DTS, you won't hear any audio when you play the disc.

Using the Features in the Menu System

Glossary

The glossary contains information about the features and controls on your DVD Player.

1. Make sure your remote is in DVD mode (press the DVD button).
2. If the disc is playing, press STOP (the DVD Player's main menu appears).
3. Press the arrow down button until *Glossary* is highlighted.
4. Press OK (the Glossary appears).
5. Press the arrow up and down buttons on your remote to highlight different terms (the definitions appear on the right side of the screen).
6. Press CLEAR to return to the DVD Player's main menu.

Some glossary definitions are more than one page (the scroll icon appears in the definition box to let you know when there's a second page).

To see the rest of the definition:

1. Press the arrow right button (the glossary definition is highlighted).
2. Press the arrow down button (the second page of the definition appears).
3. Press the arrow up button to return to the first page of the definition.

Or press GO BACK to return to the terms section of the glossary.

Divx

The Divx menu is explained in the section "All About Divx" on p. 36.

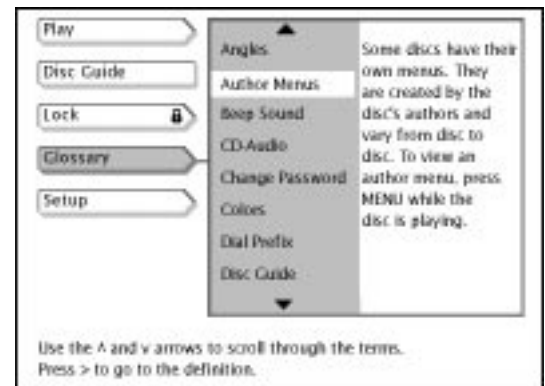

The on-screen glossary contains terms and definitions that might be helpful to you.

Some of the glossary definitions are more than one page (the scroll down icon appears in the definition box to let you know when there's a second page).

To see the rest of the definition: Press the arrow right button to highlight the definition. Press the arrow down button to see the second page.

Language Codes

Don't forget to press the OK button after you enter the code.

Language	Code	Language	Code	Language	Code
Abkhazian	6566	Hungarian	7285	Samoan	8377
Afar	6565	Icelandic	7383	Sangho	8371
Afrikaans	6570	Indonesian	7378	Sanskrit	8365
Albanian	8381	Interlingua	7365	Scots Gaelic	7168
Ameharic	6577	Interlingue	7369	Serbian	8382
Arabic	6582	Inupiak	7375	Servo-Croatian	8372
Armenian	7289	Irish	7165	Sesotho	8384
Assamese	6583	Italian	7384	Setswana	8478
Aymara	6588	Japanese	7465	Shona	8378
Azerbaijani	6590	Javanese	7487	Sindhi	8368
Bashkir	6665	Kannada	7578	Singhalese	8373
Basque	6985	Kashmiri	7583	Siswati	8383
Bengali; Bangla	6678	Kazakh	7575	Slovak	8375
Bhutani	6890	Kinyarwanda	8287	Slovenian	8376
Bihari	6672	Kirghiz	7589	Somali	8379
Bislama	6673	Kirundi	8278	Spanish	6983
Breton	6682	Korean	7579	Sundanese	8385
Bulgarian	6671	Kurdish	7585	Swahili	8387
Burmese	7789	Laothian	7679	Swedish	8386
Byelorussian	6669	Latin	7665	Tagalog	8476
Cambodian	7577	Latvian, Lettish	7686	Tajik	8471
Catalan	6765	Lingala	7678	Tamil	8465
Chinese	9072	Lithuanian	7684	Tatar	8484
Corsican	6779	Macedonian	7775	Telugu	8469
Croatian	7282	Malagsy	7771	Thai	8472
Czech	6783	Malay	7783	Tibetan	6679
Danish	6865	Malayalam	7776	Tigrinya	8473
Dutch	7876	Maltese	7784	Tonga	8479
English	6978	Maori	7773	Tsonga	8483
Esperanto	6979	Marathi	7782	Turkish	8482
Estonian	6984	Moldavian	7779	Turkmen	8475
Faroese	7079	Mongolian	7778	Twi	8487
Fiji	7074	Naru	7865	Ukrainian	8575
Finnish	7073	Nepali	7869	Urdu	8582
French	7082	Norwegian	7879	Uzbek	8590
Frisian	7089	Occitan	7967	Vietnamese	8673
Galician	7176	Oriya	7982	Volapük	8679
Georgian	7565	Oromo (Afan)	7977	Welsh	6789
German	6869	Panjabi	8065	Wolof	8779
Greek	6976	Pashto, Pushto	8083	Xhosa	8872
Greenlandic	7576	Persian	7065	Yiddish	7473
Guarani	7178	Polish	8076	Yoruba	8979
Gujarati	7185	Portuguese	8084	Zulu	9085
Hausa	7265	Quechua	8185		
Hebrew	7387	Rhaero-Romance	8277		
Hindi	7273	Romanian	8279		
		Russian	8285		

Playing CDs

Just Like Your CD Player

If you've used a CD player, you'll probably notice that your DVD player has many of the same features as a CD player.

This section explains how to play CDs and how to use the on-screen Info Display to access various playback features.

Section Overview:

- Loading and Playing an Audio CD
- Audio CD Playback Features
 - Using the Info Display
 - Selecting a Track
 - Selecting a Play Mode
 - Repeat Play
 - Using Intro Scan
 - Using Bookmarks
 - Using the Clock
- The Play Menu Items
 - Dub Assist



Playing Audio CDs

Loading and Playing an Audio CD

Before you load a disc, make sure that it is compatible with the player. Note that the following discs CANNOT be used with this player:

- Laserdisc
- CD-I, CD-ROM, CD-R, DVD-ROM
- MiniDisc

To Load and Play an Audio CD

Make sure that you have properly connected the DVD player (see "Setup and Connections") before you begin.

1. Press OPEN • CLOSE on the front of the DVD player (the disc tray opens).
2. Place a disc gently into the tray with the disc's label facing up.
3. Press the PLAY button to close the disc tray.

The DVD player reads the disc's table of contents and the disc starts to play.

4. Press STOP to stop playback.



Insert the CD into your player with the label facing up.

Audio CD Playback Features

When playing audio CDs, your DVD player has many of the same features that your CD player has, including track skip, repeat play, and programmed playback. The on-screen Info Display lets you choose various playback features.

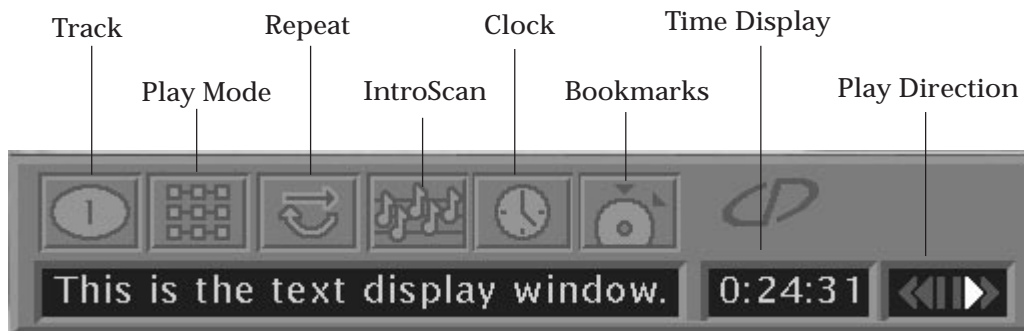

Using the Info Display

To access the Info Display, while the CD is playing, press INFO on the remote (the Info Display appears). Each of the playback features is illustrated with an icon. To access a feature, press the appropriate arrow button on the remote to highlight the icon. Each feature is described on the following pages. To make the Info Display disappear from the screen, press CLEAR on the remote control.

Note:

To see the Info Display, you must turn on your TV and tune it to its Video Input Channel

Playing Audio CDs



Selecting a Specific Track

1. Press INFO on the remote (the Info Display appears).
2. If necessary, press the arrow buttons to highlight the Track icon.
3. Use the number button(s) on the remote to enter the track number you want to play (you may need to press the OK button on the remote after you enter a single digit, track number).

Scanning Tracks on a CD

While the CD is playing, press CH + (the next track plays).

While the CD is playing, press CH- (the previous track plays).



Selecting a Play Mode

The Play Mode feature lets you set up the order in which you want the tracks on the CD to play. There are three options:

Standard: the tracks play in the order listed on the CD (starting with track 1).

Random: the tracks on the CD play in random order.

Program: the tracks on the CD play in the order that you choose. You create your program playlist in the *Play* menu of the DVD Player's main menu (this is the menu that appears on the screen when you first turn on the player).

Shortcut: Press PLAY MODE on the remote when a disc is playing.

Scanning an Individual Track

Press FORWARD or REVERSE on the remote while you're playing the CD.

Switching between Standard and Random Play

Standard (the order listed on the CD) is the default setting for your player. To change the setting:

1. Press INFO on the remote while a disc is playing (the Info Display appears).
2. Press the arrow right button until the Play Mode icon is highlighted, and press OK (the Play Mode menu appears).



3. Press the arrow button on the remote to highlight Random, and press OK.
4. Press the arrow down button to highlight *Done*, and press OK (the Info Display appears on the screen).

Note:

The player defaults to Standard playback whenever you put a new CD into your player.

Program Playback

To use the Program playback option, you must enter the order in which you want the tracks on the CD to play.

1. Make sure the CD is in the player, but not playing.
2. Make sure *Play* is highlighted in the DVD Player's main menu and press OK (the *Play* menu items appears).
3. Press the arrow down button to highlight *Edit Program*, and press OK (the program menu appears).
4. Use the number buttons on the remote to enter the track you want to play first (the cursor highlights *Add*).
5. Press OK to add that track into the *Program List* (the cursor jumps to the *Track* section).
6. Continue adding tracks as explained in steps 4-5 until your program is complete.
7. To play your program right away, highlight *Play* and press OK (the tracks on the CD start playing in the order in which you programmed).

If you want to store the program's playlist, press the appropriate arrow button on the remote to highlight *Done* and press OK.

Note:

To resume normal playback, press GO BACK and then press PLAY.



To create a program, go to the *Edit Program* option in the *Play* menu.

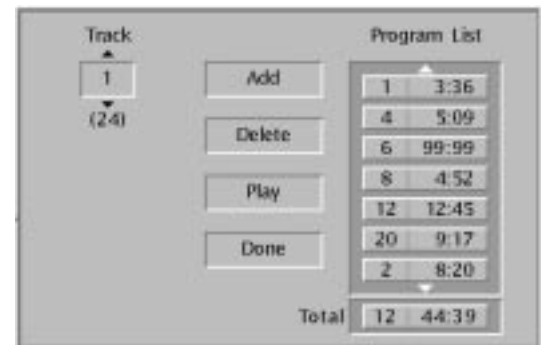

To create your program list, use the number button(s) on the remote to enter a track number. Press OK to add that track to your list.

Deleting and Editing a Program

To edit your program or delete it, go to the DVD Player's main menu, highlight *Play*, and press OK.

1. Press the arrow down button to highlight *Edit Program*. Press OK.
2. Press the arrow right button until the *Playlist* items are highlighted.
3. Use the arrow up and down buttons to highlight the item in the playlist you want to delete.
4. Highlight *Delete*, and press OK.
5. When you've rearranged the playlist and/or deleted all the tracks necessary. Press OK.

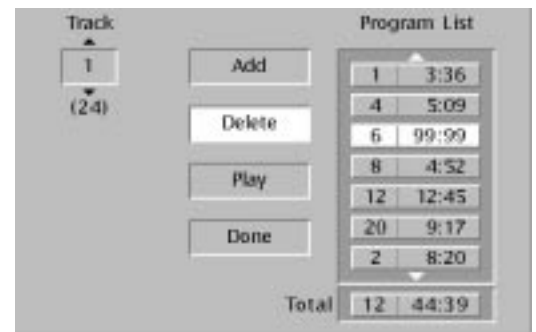

To delete tracks from the *Program List*, use the arrow button to highlight the track. Highlight *Delete* and press OK on the remote.

Playing Audio CDs



Repeat Play

You can tell the player to repeat the entire disc, a track, or you can set A•B repeat.

To repeat the disc or a track:

1. While the CD is playing, press INFO on the remote (the Info Display appears).
2. Press the arrow right button until the Repeat icon is highlighted. Press OK.
3. Highlight the *Disc* selection or the *Track* selection.
4. Press OK.
5. Press the down arrow button to highlight *Done*.
6. Press OK (the player will play the CD or the track over and over again).

Note:

Your repeat settings are erased each time you remove a CD.

Shortcut: Press REPEAT on the remote while a CD is playing.

Cancel Repeat

To cancel Repeat:

1. Press INFO on the remote while the CD is playing.
2. Press the arrow buttons to highlight the Repeat button and press OK.
3. Press the arrow right button until *Off* is highlighted. Press OK.
4. Press the down arrow button to highlight *Done* and press OK.

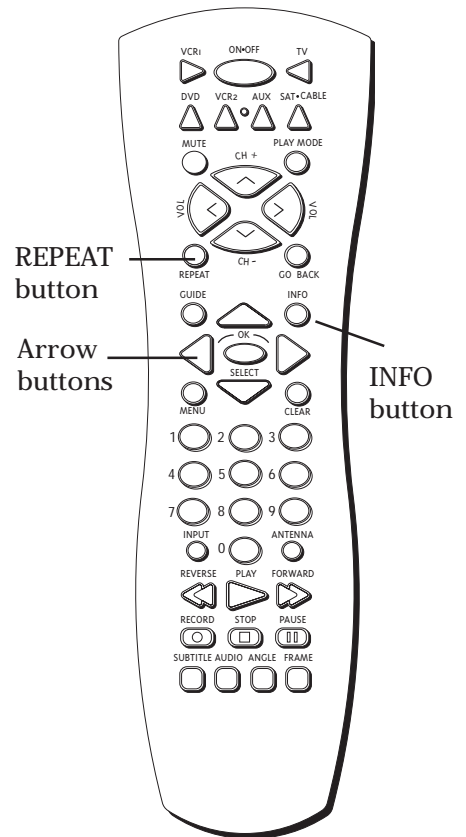

A•B Repeat Deserves Some Extra Instruction

A•B Repeat lets you repeat a specific segment on the CD that you define. For example, if you want to listen to a particular guitar riff within a song, you can set the A•B Repeat to play that part of the song over and over.

1. Press INFO on the remote (the Info Display appears).
2. Press the arrow buttons to highlight the Repeat icon, and press OK. (The Repeat menu appears.)

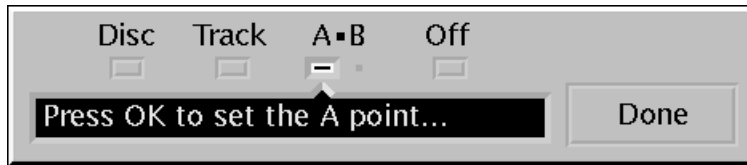

3. Press the arrow button to select A•B (*Press OK to set the A point* appears on the screen).
4. Press FORWARD or REVERSE on the remote to move to the part of the CD that you want to be the beginning of the segment that is going to repeat (the A point).
5. Press OK.
6. Press FORWARD or REVERSE on the remote to go to the part of the disc that you want to be the end of the segment that will repeat (the B point).
7. Press OK.
8. Press the down arrow to highlight *Done* and press OK (the Info Display appears on screen).

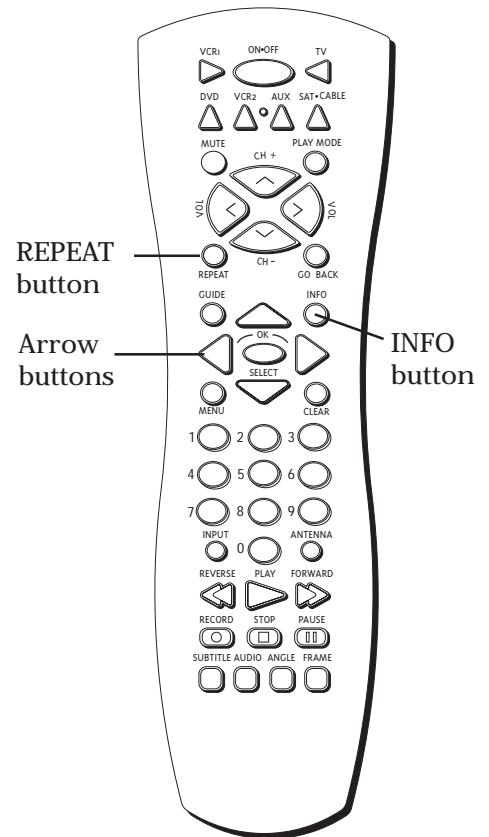

Playing Audio CDs



Using IntroScan

IntroScan plays the first few seconds of each track on the CD— similar to the scan feature that's on many car radios. To use IntroScan:

1. Press INFO on the remote (the Info Display appears).
2. Press the right arrow button to highlight the IntroScan icon. Press OK (the first few seconds of each track play).
 - After IntroScan goes through all of the tracks, it stops.
 - If you want to stop IntroScan while it's in progress, just press PLAY on the remote (the current track starts playing in its entirety).
 - You can also access IntroScan from the *Play* menu in the DVD Player's main menu.



Using Bookmarks

The bookmark feature lets you mark a point on the disc that you can go to quickly. You can store up to 10 bookmarks.

Storing a Bookmark

1. While a disc is playing, press INFO on the remote (the Info Display appears).
2. Use the right arrow button to highlight the Bookmark icon.
3. Press OK (the Bookmark menu appears).



4. When you reach the part of the track that you want to mark, press OK.
5. Press the arrow down button to highlight *Done*.
6. Press OK.
7. Press CLEAR on the remote to make the Info Display disappear from the screen.

Recalling a Bookmark

1. While you're playing a disc, press INFO on the remote (the Info Display appears).
2. Press the right arrow buttons until the Bookmark icon is highlighted.
3. Press OK.
4. Use the up arrow button (and right arrow button if necessary) to select the bookmark.
5. Press OK to activate the bookmark.
6. To return to the Info Display, press the down arrow button until *Done* is highlighted and press OK.
7. Press CLEAR on the remote to make the Info Display disappear from the screen.



Using the Clock

The Clock part of the Info Display shows you how much time is left and how much time has elapsed.

1. Press INFO on the remote (the Info Display appears).
2. Press the arrow right button to highlight the Clock icon. Press OK (the amount of time the track has played appears in the time window).
3. Press OK again (the amount of time remaining in the track appears in the time window).
4. Press OK again (the amount of time that has played on the CD appears in the time window).
5. Press OK again (the amount of time remaining on the CD appears in the time window).



The time display

Playing Audio CDs

The Play Menu Items

All of the items in the *Play* menu (of the DVD Player's main menu), except Dub Assist, have already been explained in the section "Using the Features in the Menu System."

Standard Play: page 66

Random Play: page 66

Edit Program: page 67

IntroScan: page 70



To access the *Play* menu items for your CD, highlight *Play* and press OK.

Dub Assist

Dub Assist helps you record a CD onto an audio cassette tape by determining the amount of tracks that will fit on one side of the tape so you have time to turn the tape over to record on the other side.

To use Dub Assist when you're recording a CD onto an audio cassette:

1. Press STOP if a CD is playing (the DVD Player's main menu appears).
2. Press the arrow buttons to highlight *Play* and press OK (the *Play* options appear).
3. Press the arrow down button until *Dub Assist* is highlighted and press OK (the *Dub Assist* screen appears).
4. When the *Segment Length* box is highlighted, use the up and down arrow buttons to enter the length of one side of the audio cassette.
5. Press the arrow right button to go to the next window and choose Standard, Optimized, or Program.

Standard: This is the default mode. The tracks are recorded in the order on the CD (track 1 is recorded first, track 2 second, etc.)

Optimized: The tracks are recorded in the order that optimizes the number of tracks that can fit on one side of the audio cassette so you have the least amount of dead space between songs.

Program: The tracks are recorded in the order you program. You must create your program in the *Edit Program* menu that's in the DVD Player's *Play* menu.

6. After you choose Standard, Optimized, or Program, press OK (the order the tracks will be recorded appears in the Segment box).
7. Press the down arrow button on the remote to highlight *Start* and press OK.
8. Follow the instructions on the screen to begin recording.

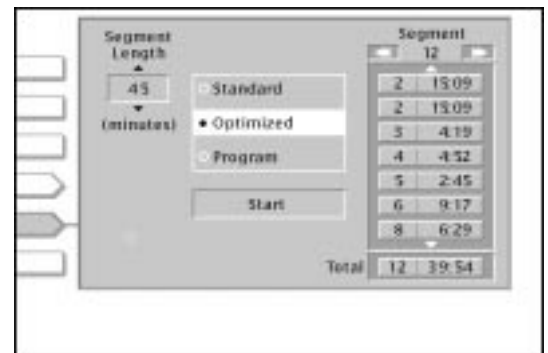

Dub Assist helps you record a CD onto an audio cassette.

Assistance

Section Overview:

Troubleshooting

If you're having any problems with your DVD Player, read the troubleshooting section to find a solution. Troubleshooting is divided into three categories:

- Common problems
- Disc problems
- Divx problems

Care and Maintenance

- Handling Cautions for the Player
- Maintenance of the Cabinet
- Formation of Condensation
- Cleaning and Handling Discs

Limited Warranty

The Limited Warranty includes information on getting service for your DVD Player.

Assistance Section

How to Resolve Product Performance Problems

If you are experiencing product operation problems, please review the troubleshooting section before you call for service. If your operation problem relates to playing a Divx disc or Divx features but you are able to play regular CD audio and DVD discs, please call Divx toll-free at 1-888-456-DIVX (1-888-456-3489).

If you are experiencing a problem that doesn't relate to Divx discs or other Divx features, please refer to the Limited Warranty (p. 79) for information on how to obtain repair service.

Player Performance Problem?

1. Review troubleshooting (pp. 74-77)
2. If the problem relates to Divx discs or Divx features, call Divx at 1-888-456-DIVX (1-888-456-3489).
3. For other problems, refer to the Limited Warranty for service information.

Troubleshooting

Common Problems	Solutions
Player won't work	Reset the DVD Player by unplugging the AC power cord and plugging it back in.
No Power	Plug in the DVD Player. Make sure both ends of the AC power cord are securely plugged into the player and into an AC outlet.
Power turns itself off	The power is automatically turned off after the player has been stopped for approximately 30 minutes (auto power-off feature). Turn power back on.
Disc won't play	<ul style="list-style-type: none">• Insert a disc with the label side facing up.• Check the type of disc you put into the player. This player only plays DVD discs, Divx discs, and audio CDs.
Play starts, but then stops immediately	<ul style="list-style-type: none">• The disc is dirty. Clean it.• Condensation has formed. Allow player to dry out.
No picture	<ul style="list-style-type: none">• Turn your TV to its Video Input Channel (see p. 14).• Turn on the TV.• Make sure your player is connected properly.
No sound or distorted sound	<ul style="list-style-type: none">• Make sure your player is connected properly. Make sure all cables are securely inserted into the appropriate jacks.• You may need to readjust the setting in the <i>Audio Equipment</i> menu (it is in the <i>Sound</i> menu within the <i>Setup</i> menu). Set it to <i>PCM</i> unless you have connected a Dolby Digital or DTS receiver (or decoder) to your DVD Player. See page 60.• Turn your TV to its Video Input Channel (see p. 14).• Sound is muted during still, frame advance, or slow-motion play.• If you connected an audio receiver to your DVD Player, make sure you choose the correct input setting on the receiver.

Troubleshooting

Common Problems	Solutions
Remote control won't work	<ul style="list-style-type: none"> • You might be in the wrong mode. To operate your DVD Player, press DVD on the remote before you press any other buttons. If you're operating the TV, press the TV button first, etc. • Insert new batteries in the remote. • Operate the remote control at a distance of no more than 20 feet. • Remove any obstacles between the remote and the DVD Player or other component. If your DVD Player is in an entertainment cabinet, the glass doors may be obstructing the remote control from operating the unit. Open the doors. • Remove batteries and hold down one or more buttons for several minutes to drain the microprocessor inside the remote to reset it. Reinstall batteries and try remote again.
Can't advance through a movie	<ul style="list-style-type: none"> • You can't advance through the opening credits and warning information that appear at the beginning of movies because the disc is programmed to prohibit that action.
The  icon appears on screen	<ul style="list-style-type: none"> • The feature or action cannot be completed at this time because: <ol style="list-style-type: none"> 1. The disc's software restricts it. 2. The disc's software doesn't support the feature (e.g., angles). 3. The feature is not available at the moment 4. You've requested a title or chapter number that is out of range.
The picture is distorted	<ul style="list-style-type: none"> • Did you connect your VCR to the DVD Player? Disconnect it. • The disc might be damaged. Try another disc.
Picture is distorted during forward and reverse scan	It is normal for some distortion to appear while scanning.
A screen saver appears on the TV	<ul style="list-style-type: none"> • Your player is equipped with a screen saver (the RCA logo) that appears on the TV when your player is idle for several minutes. There are a few ways to make the screen saver disappear from the screen and return to the player's main menu: press STOP, CLEAR, or GO BACK on the remote.

More troubleshooting on the next page

Assistance Section

Troubleshooting

Common Problems	Solutions
Subtitle and/or audio language is not the one selected from the initial setting	If the subtitle and/or audio language does not exist on the disc, the initial settings will not be seen/heard. The disc's priority language is selected instead. Set the subtitle and/or audio language manually through the Info Display.
The menu is displayed in a foreign language	The Menu Language preference is set to that language. Go to <i>Language Prefs</i> in <i>Setup</i> menu and select the language you prefer. See p. 57.
Play doesn't begin when you press PLAY	The rating of the title on the disc exceeds the rating limit set in the <i>DVD Limits</i> <i>Divx Limits</i> menu. Unlock the player or change the rating limit in those menus.
No forward or reverse scan	<ul style="list-style-type: none">• Some discs have sections that prohibit rapid scanning, or title and chapter skip.• If you're trying to skip through the credits warning information at the beginning of a movie, you won't be able to. This part of the title (movie) is often programmed to prohibit skipping through it.
Disc won't play	Both the player and the disc are coded by region. If the regional codes don't match, the disc cannot be played. This player is Region No. 1.
Desired angle cannot be changed	Some discs don't have the multi-camera angle system, and some discs only have it in certain parts of the movie.
Picture has wrong aspect ratio	Change the <i>TV Image</i> setting in the <i>Setup</i> menu. See p. 58.
I forget the password	Your player is equipped with a "back-door" unlock sequence. Press and hold the STOP button on the front of the DVD Player and the STOP button on the remote control at the same time. (Hold both buttons down at the same time for at least 3 seconds).
Cannot copy discs to video tape	You can't record digital video discs onto videocassettes because the discs are encoded with anti-copy protection.
Disc tray won't open	Disengage the dealer tray lock feature. Press and hold a combination of buttons on the front panel at the same time. Press and hold STOP, ON•OFF, and OPEN•CLOSE for at least three seconds.
Disc won't eject	When you put a disc into the player, the player reads the disc which may take up to 15 seconds. You won't be able to eject the disc during this time. Wait 15 seconds and try again.

Troubleshooting

Divx Problems	Solutions
Player won't play Divx discs, but it plays regular discs	<ul style="list-style-type: none"> • If you haven't set up an account with Divx, call 1-888-NEW-DIVX. • Make sure you've connected the telephone line cord. • Follow any instructions that appear on the screen.
Can't connect to Divx	<ul style="list-style-type: none"> • Make sure phone service is active. • Make sure the phone line is securely connected to the back of your player. • Somebody else may be on the phone. The phone can't be used for regular calls at the same time you're connecting to Divx. • If you use a voicemail or messaging service through the phone company, make sure you clear all messages. The delayed tone to alert you of calls interrupts the Divx connection. • If you have to dial a special number to make phone calls, you need to enter that number in the <i>Dial Prefix</i> menu that's contained within the <i>Divx</i> menu. See p. 13 in "Setup and Connections" or p. 40 in "Using Your DVD Player's Menu System."
Screen freezes when the player is calling Divx	<ul style="list-style-type: none"> • Did somebody pick up the phone? Reset the player by unplugging it from its power source and plugging it back in.
There isn't any player information on the initialization screen	<ul style="list-style-type: none"> • Call Divx at 1-888-456-DIVX (1-888-456-3489)
Mail message won't erase	<ul style="list-style-type: none"> • Try resetting the player by unplugging it and plugging it back in.
Specials message won't erase	<ul style="list-style-type: none"> • Divx erases Specials messages when they're outdated. You can't erase a Specials message.
A message has disappeared	<ul style="list-style-type: none"> • Specials messages are deleted by Divx when they're outdated. • Your mailbox might be full — the previous message was deleted. Make sure you review your mail periodically and delete old messages. • Follow any instructions that may appear on the screen.

Assistance Section

Handling Cautions

- Before connecting other components to this player, be sure to turn them all off.
- Do not move the player while a disc is being played, or the disc may be scratched or broken, and the player's internal parts may be damaged.
- Do not put a flower vase filled with water or any small metal objects on the player.
- Be careful not to put your hand into the disc tray.
- Do not place anything other than the disc in the disc tray.
- Exterior influences such as lightning and static electricity can affect normal operation of this player. If this occurs, turn the player off and on again with the POWER button, or disconnect and then reconnect the AC power cord to the AC power outlet. The player will operate normally.
- Be sure to remove the disc and turn off the player after use.

Maintenance of Cabinet

For safety reasons, be sure to disconnect the AC power cord from the AC outlet.

- Do not use benzene, thinner, or other solvents for cleaning.
- Wipe the cabinet with a soft cloth.

Formation of Condensation

Due to sharp changes in temperature and humidity, condensation may form if warm air comes in contact with any cold parts inside the player.

- When condensation forms inside the player, the player may not operate correctly. If this occurs, leave the player at room temperature until the inside of the player becomes dry and operational.
- If condensation forms on a disc, wipe the disc with a soft and dry cloth by moving the cloth from the center hole toward the outer edge.

Handling Discs

- Do not touch their signal surfaces. Hold by the edges or by one edge and the hole in the center.
- Do not affix labels or adhesive tape to label surfaces. Also, do not scratch or damage the label.
- Discs rotate at high speeds inside the player. Do Not use damaged (cracked or warped) discs.

Cleaning Discs

- Dirty discs can cause reduced video and audio performance. Always keep discs clean by wiping them gently with a soft cloth from the inner edge toward the outer perimeter.
- If a disc becomes very dirty, wet a soft cloth in water, wring it out well. Wipe the dirt away gently, and then remove any water drops with a dry cloth.
- Do not use record cleaning sprays or anti-static agents on discs. Also, never clean the discs with benzene, thinner, or other volatile solvents which may cause damage to the disc surface.

How to Resolve Product Performance Problems

If you are experiencing product operation problems, please review the troubleshooting section before you call for service. If your operation problem relates to playing a Divx disc or Divx features but you are able to play regular CD audio and DVD discs, please call Divx toll-free at 1-888-456-DIVX (1-888-456-3489).

If you are experiencing a problem that doesn't relate to Divx discs or other Divx features, please refer to the Limited Warranty (see below) for information on how to obtain repair service.

Limited Warranty

RCA Digital Video Disc (DVD) Player with Divx Capability

What your warranty covers:

- Any defect in materials or workmanship.

For how long after your purchase:

- 90 days - Unit exchange, which includes parts and labor.
- 91 days to 1 year - Unit exchange, which includes parts only; you pay the labor.
- The warranty for rental units begins with the first rental or 45 days from date of shipment to the rental firm, whichever comes first.

What we will do:

During the initial 90 days:

Exchange the DVD unit with a new or, at our option, refurbished unit.

After the 90 days and within one year:

Exchange the DVD unit with a new or, at our option, refurbished unit. We will bill you a flat exchange charge to replace a defective unit. This charge covers the labor cost for its repair.

What Your Warranty *Does Not* Cover:

- Product operation and adjustment of customer controls.
- Acts of God, such as but not limited to lightning damage.
- Damage from misuse or neglect.
- A unit that has been modified or incorporated into other products or is used for institutional or other commercial purposes.
- Batteries.
- Units purchased or serviced outside the U.S.A.
- Shipping damage if the unit was not packed and shipped in the manner prescribed by Thomson.
- Storage fees may be charged by the exchange point if you fail to pick up the replacement unit in a timely manner.

How to get repair service:

- If you are having a service related problem, call toll free 1-800-311-9263 (USA).
- A representative will troubleshoot your problem over the phone.
- If it is determined that you should receive a replacement unit, you will be provided with a Return Authorization (RA) number and the location of a nearby exchange point if one exists. No returns will be accepted without the RA number.

(continued on next page)

Assistance Section

To receive a replacement unit before you return yours:

Direct to Consumer Exchange

1. Provide your Discover, MasterCard or Visa account number and expiration date to your phone representative. This is for security purposes only and your account will not be charged at this time.
2. We will send you a replacement unit.
3. If you return the unit to us within 14 days from the date you were provided a Return Authorization number, only items not covered by warranty will be charged to your account. If your unit is not received within 14 days, the suggested retail value of the unit will be charged to your credit card. This amount will be credited if the unit is subsequently received.
4. Ship your defective unit back to us, excluding all accessories, using the replacement unit's carton. Shipping instructions will be included on the carton along with your RA number which will allow you to easily ship the unit back to us. Make sure you insure your shipment in case of damage or loss. Include with the shipment:
 - Evidence of purchase date such as a bill of sale, to verify your unit's warranty eligibility.
 - A brief note describing your unit's problem.
 - Your name, address and phone number.

Thomson assumes no responsibility of warranty shipments from the customer to the factory if not shipped in the manner prescribed by Thomson.

Return transportation, storage, handling and insurance costs are your responsibility. We accept no responsibility in case of damage or loss.

Replacement through an Exchange Point

1. We will send a replacement unit to our exchange point.
2. The exchange location will notify you of its arrival.
3. Take your unit and your evidence of purchase date, such as a bill of sale, to the exchange location and you will be provided the new or refurbished unit. Please retain all accessories such as the remote control hand unit.
4. If the repairs are covered by your warranty, you will not be billed.
5. A handling charge may be assessed.

To receive a replacement unit after we have received your unit:

- Write the RA number on the outside of the carton used to return the unit. Make sure you insure your shipment in case of damage or loss.
- Carefully pack the unit using the original box and packing material if possible. Please retain all accessories that were included with your unit such as the remote control hand unit.
- Include with the shipment:
 1. Evidence of purchase date such as a bill of sale, to verify your unit's warranty eligibility.
 2. A brief note describing your unit's problem.
 3. Your name, address and phone number.
- The representative will advise the address to mail a cashier's check or money order for payment if there are any out of warranty labor or parts charges, and you elect not to use your credit card.
- After we receive your product, a new or refurbished unit will be shipped to you.

Product Registration:

- Please complete and mail the Product Registration Card packed with your DVD product. It will make it easier to contact you should it ever be necessary. The return of the card is not required for warranty coverage.

How State Law Relates to Warranty:

- This warranty gives you specific legal rights and you may have other rights that vary from state to state.

If You Purchased Your Product Outside the United States:

- This warranty does not apply. See your dealer for warranty information.

Reference

Section Overview:

About the DVD Player

- Description of the front panel
- Description of front panel display lights
- Basic use and care guidelines

Programming the Remote

This section describes how to program the remote control to operate other components (TV, VCR, etc.) The remote automatically operates most RCA, GE, and PROSCAN components.

Detailed information about the remote control buttons is in the Setup and Connections section (pp. 15-18).

Accessories

The Accessories section lists some extra things you might want to order to use with your DVD Player. You can send in the form or call the 800-number listed.

FCC Information

Index

Reference

Front Panel Controls

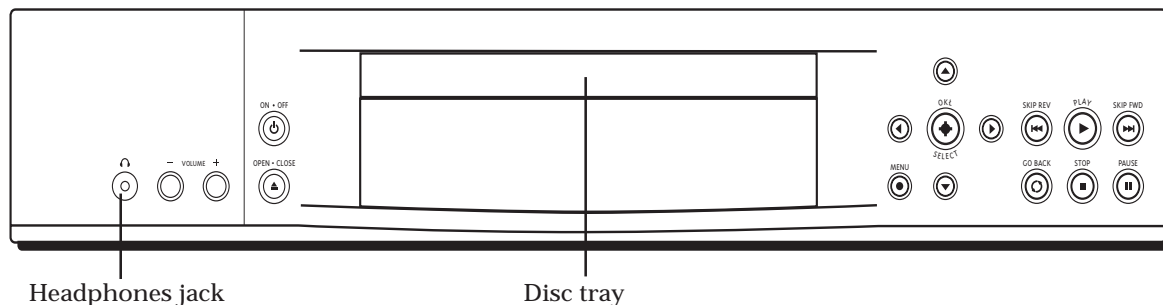

Disc Tray Press OPEN•CLOSE to open and close the disc tray.

Front Panel Display (See following page for details.)

Headphones Jack You can attach headphones here for private listening.

ON•OFF Button and ON•OFF Indicator Light Turns the player on and off. The ON•OFF indicator lights when the player is on.

OPEN•CLOSE Press to open and close the disc tray.

PAUSE Pauses disc play (also used for frame advance).

PLAY Begins disc play (and closes disc tray if open).

SKIP FWD Allows you to move to the beginning of the next title, chapter, or track on a disc (in effect, “skipping” the title, chapter, or track).

SKIP REV Allows you to move to the beginning of the preceding title, chapter, or track on a disc (in effect, “skipping” the title, chapter, or track).







STOP Stops disc play.

VOLUME (+ and -) Adjusts the headphone, volume level.

Front Panel Display



Display lights listed from left to right (top row first)

1. NO DISC There isn't a disc in the disc tray.
2. DIVX Lights when you play a Divx disc.
3. DVD Lights when you play a DVD disc.
4. VIDEO Not applicable.
5. TITLE Indicates the title that is playing.
6. PROGRAM The disc is playing the chapters (or tracks) in the order you programmed.
7. CHAPTER Indicates the chapter that is playing.
8. PBC Not applicable.
9.  (Play direction) Indicates whether the disc is paused, moving forward, or backward.
10. The display. Some of the key messages are:
 - BYE Displayed when you turn off the player.
 - HELLO Displayed when you first turn on the player.
 - NO PLAY Disc cannot be played (wrong Region Number, or rating is locked).
 - PAUSE Disc is in pause mode.
 - PLAY Disc is playing.
 - SEARCH Player is in search mode (forward or backward).
 - SLOW Slow motion playback mode.
 - STILL Still frame.
11.  Unlocked Indicates the player is unlocked (no password required to play discs).
12.  Locked Player is locked. You must enter password to play discs with rating limits higher than those you entered in the *Ratings* menu.
13.  (Mail icon) Indicates you have new messages in your Divx mailbox.
14. RANDOM The disc is playing the chapters (or tracks) in random order.
15.  (Angle) Indicates that the angle feature is available.
16.  Repeat Indicates that the Repeat feature has been activated.

Reference

Programming the Remote

The universal remote can be programmed to control most brands of remote controllable TVs, VCRs, satellite receivers and cable boxes. The remote is already programmed to control most RCA, PROSCAN, and GE TVs, VCRs, DVD players and satellite receivers.

Testing the remote

To determine whether the universal remote needs to be programmed, turn a device ON, such as a VCR, point the remote at the VCR, and press the VCR1 button. Then press POWER or CH ^ (channel up) or CH v (channel down) to see if the VCR responds to the remote commands. If not, the remote needs to be programmed.

Programming the remote

There are two ways to program the remote control: automatic code search and direct entry.

Using Automatic Code Search

The following instructions can be used to program the remote to operate each of the components connected to your DVD Player. If you want to exit the automatic code search without programming any of your components, press CLEAR until the red light on the remote turns off.

1. Turn on the component you want to operate (VCR, TV, etc.)
2. Press and hold the button you want to program (VCR1, VCR2, etc.). While holding the component button, press and hold ON•OFF until the red light on the remote turns on, then release both buttons.
3. Point the remote at the component. Press and release PLAY, then wait 5 seconds or until the red light on the remote stops flashing.

At this point the remote is searching for the correct code to program. If, after 5 seconds, the component you want to operate does not turn off, press PLAY again to tell the remote to search the next set of codes.

Continue pressing PLAY until the component turns off or you have searched through all of the codes. There are 20 total sets of codes. If the component does not turn off after pressing PLAY 20 times, then the remote cannot be programmed to operate that component.

If the component you want to control *does* turn off:

1. Press and release REVERSE, then wait 2 seconds. Repeat this step until the device turns back ON.
2. To finish, press and hold STOP until the red light on the remote turns off.

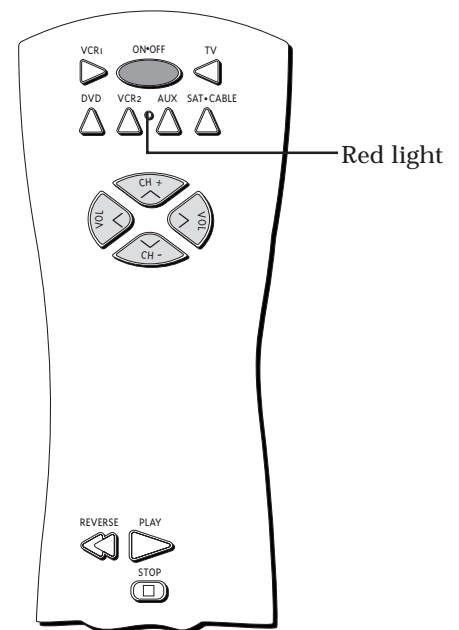

You'll use these buttons when you program the remote to operate a component. The remote may not operate all models of all brands.

Using Direct Entry

1. Turn on the component to be programmed.
2. Look up the brand and code number(s) for the component on the code list in this section.
3. Point the DVD Player's remote at the component.
4. Press and hold the component button on the remote you want to program.
5. Enter the code from the Remote Control code list (pp. 86-87).
6. Release the component button, and then press ON•OFF to see if the component responds to the command. If it doesn't, try pressing the component button and then ON•OFF again.
7. If you get no response, repeat these steps using the next code listed for your brand, until the component responds to the remote commands.

To operate another component after you've programmed the remote control:

1. Press the appropriate component button (TV, VCR1, VCR2, DVD, AUX or SAT•CABLE) to set the remote to control the component.
2. Press ON•OFF to turn the component ON or OFF.
3. Use the remote buttons that apply to that component.

Modes of Operation

Because this universal remote can control several different components (DVD player, VCR, cable box, etc.) it uses operational modes triggered by the component buttons. For example if you want the remote to control the TV, you would press the TV button to put the remote into TV mode before you could control the TV.

Note:

This remote may not be compatible with all brands and models of components.

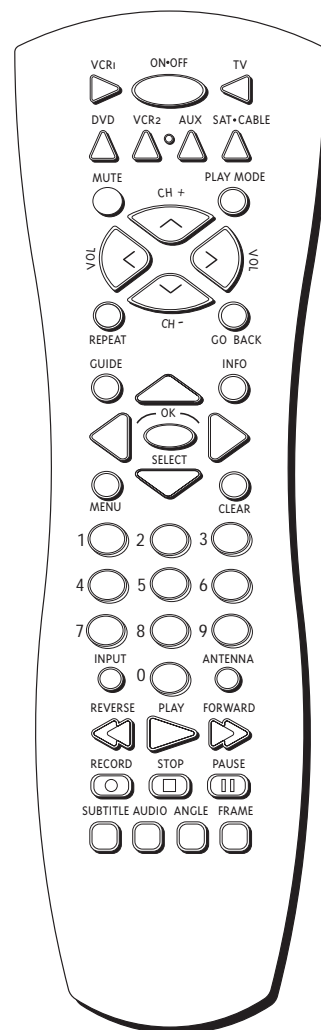

This Is Important!

You must *continue pressing* the component button *while* you enter the code.

Let's say you have a Zenith TV. To program the remote to operate the TV you would:

Press and hold the TV button while you enter the first code listed for Zenith in the TV Codes column.

Release the TV button. Press ON•OFF to see if the TV responds. If it doesn't, follow the same steps, but enter the second code instead of the first.

Remote Control Code List

TV Codes

Abex	1172
Admiral	1001
Aiko	1016
Alleron	1046
Amtron	1038
Akai	1002
Anam National	1003, 1038
AOC	1004, 1005, 1006, 1007
Audiovox	1038
Belcor	1004
Bell & Howell	1001, 1162
Bradford	1038
Brokwood	1004
Candle	1004, 1006, 1008
Celebrity	1002
Citizen	1004, 1006, 1008, 1016, 1038, 1105, 1171
Colortyme	1004, 1006
Concerto	1004, 1006
Contec/Cony	1012, 1013, 1014, 1038
Craig	1038
Crown	1038, 1171
Curtis Mathes	1000, 1004, 1006, 1015, 1105, 1162, 1171
CXC	1038
Daewoo	1004, 1005, 1006, 1016, 1017, 1018, 1127, 1171
Daytron	1004, 1006, 1171
Dimensia	1000
Dumont	1004, 1151
Electroband	1002
Electrohome	1003, 1004, 1006, 1019, 1022
JBL	1062
JCB	1002
JC Penny	1000, 1004, 1005, 1006, 1008, 1022, 1052, 1054, 1058, 1063, 1064, 1072, 1087, 1105, 1128, 1171, 1172, 1181
Jensen	1004, 1006
JVC	1012, 1013, 1054, 1060, 1065, 1066, 1067, 1089, 1157, 1158, 1159
Kawasho	1002, 1004, 1006
Kenwood	1004, 1006, 1019
Kloss Novabeam	1068, 1069, 1183
KTV	1038, 1070, 1171
Loewe	1062
Luxman	1004, 1006
Lxi	1000, 1006, 1049, 1062, 1071, 1072, 1073, 1162, 1181
Magnavox	1004, 1006, 1008, 1019, 1062, 1068, 1069, 1074, 1075, 1076, 1077, 1088, 1089, 1130, 1131, 1132, 1133, 1134, 1183, 1184
Marantz	1062
Marantz	1004, 1006, 1062
Megatron	1006, 1059
Memorex	1001, 1006, 1082, 1162
MGA	1004, 1005, 1006, 1019, 1022, 1051, 1079, 1080, 1082
Midland	1054, 1151, 1171, 1172, 1181
Minutz	1052
Mitsubishi	1004, 1005, 1006, 1019, 1022, 1051, 1079, 1080, 1081, 1082, 1082, 1125
Motorola	1003
MTC	1004, 1005, 1006, 1105
Multitech	1038
Multivision	1084
NAD	1006, 1071, 1072
NEC	1003, 1004, 1005, 1006, 1089
Nikko	1006, 1016
NTC	1016
Onwa	1038

Orion	1035
82Panasonic	1003, 1054, 1062, 1170
Philco	1003, 1004, 1005, 1006, 1008, 1012, 1019, 1062, 1068, 1069, 1074, 1075, 1077, 1183, 1184
Philips	1003, 1004, 1008, 1012, 1019, 1062, 1068, 1069, 1074, 1075, 1076, 1086, 1087, 1088, 1089
Pilot	1004, 1171
Pioneer	1004, 1006, 1090, 1091, 1092, 1179
Portland	1004, 1005, 1006, 1016, 1171
Price Club	1105
Prism	1054
PROSCAN	1000, 1181
Proton	1004, 1006, 1012
Pulsar	1151
Pulser	1004
Quasar	1003, 1054, 1070, 1094
Radio Shack/Realistic	1000, 1004, 1006, 1012, 1038, 1049, 1162, 1171, 1172
RCA	1000, 1003, 1004, 1005, 1006, 1007, 1019, 1096, 1098, 1099, 1100, 1101, 1102, 1103, 1129, 1179, 1181, 1187, 1188, 1190
Runco	1151
Sampo	1004, 1006, 1171, 1172
Samsung	1004, 1005, 1006, 1012, 1015, 1019, 1104, 1105, 1106, 1171, 1172
Samsux	1171
Sanyo	1004, 1048, 1049, 1050, 1080, 1107, 1108, 1162, 1180
Scotch	1006
Scott	1004, 1006, 1012, 1024, 1035, 1038, 1046
Sears	1000, 1004, 1006, 1013, 1019, 1046, 1048, 1049, 1050, 1051, 1066, 1071, 1072, 1109, 1110, 1162, 1180, 1181
Sharp	1004, 1006, 1012, 1029, 1111, 1112, 1113, 1122, 1171
Shogun	1004
Signature	1001, 1115
Simpson	1008
Sony	1002
Soundesign	1004, 1006, 1008, 1038, 1046
SSS	1004, 1038
Starlite	1038
Supreme	1002
Sylvania	1004, 1006, 1008, 1019, 1062, 1068, 1069, 1074, 1075, 1076, 1077, 1088, 1116, 1161, 1183, 1184
Symphonic	1033, 1038
Tatung	1003
Technics	1054
Techwood	1004, 1006, 1054
Teknika	1004, 1005, 1006, 1008, 1012, 1013, 1016, 1038, 1046, 1076, 1082, 1083, 1105, 1170, 1171
Telecaption	1117
TMK	1004, 1006
Toshiba	1049, 1071, 1072, 1089, 1105, 1109, 1117, 1118, 1160, 1162
Totevision	1171
Universal	1052, 1087
Victor	1066
Vidtech	1004, 1005, 1006
Wards	1000, 1001, 1004, 1005, 1006, 1019, 1024, 1033, 1046, 1052, 1062, 1069, 1074, 1075, 1076, 1083, 1087, 1088, 1095, 1119, 1120, 1184
Yamaha	1004, 1005, 1006, 1019
Zenith	1004, 1151, 1152, 1153, 1154

Cable Box Codes

ABC	5002, 5003, 5004, 5005, 5006, 5007, 5053
Antronix	5008, 5009
Archer	5008, 5009, 5010, 5011
Cabletenna	5008
Cableview	5008
Century	5011
Citizen	5011
Colour Voice	5012, 5013
Comtronics	5014, 5015
Contec	5016
Eastern	5017
Garrard	5011
GE Electronics	5009
Gemini	5018, 5019, 5049
General Instrument	5003
Hamlin	5020, 5021, 5022, 5035, 5045
Hitachi	5003
Hytex	5002
Jasco	5011
Jerrold	5003, 5005, 5007, 5018, 5023, 5024, 5046, 5053
Magnavox	5025
Memorex	5026
Movie Time	5002, 5027, 5028
NSC	5002, 5027, 5028
Oak	5002, 5016, 5029
Panasonic	5048, 5052
Paragon	5026
Philips	5011, 5012, 5013, 5019, 5025, 5030, 5031, 5032
Pioneer	5033, 5034
Pulsar	5026
RCA	5047, 5049, 5052
Realistic	5009, 5049
Regal	5022, 5035
Regency	5017
Rembrandt	5003
Runco	5026
Samsung	5014, 5034
Scientific Atlanta	5006, 5036, 5037, 5038
Signal	5014, 5018
Signature	5003
SI Marx	5014
Sprucer	5052
Starcom	5007, 5018, 5053
Stargate	5014, 5018
Starquest	5018
Tandy	5040
Television	5014
Tocom	5004, 5023, 5041
Toshiba	5026
Tusa	5018
TV86	5027
Unika	5008, 5009, 5011
United Artists	5002
United Cable	5053
Universal	5008, 5009, 5010, 5011
Videoway	5044
Viewstar	5015, 5025, 5027, 5040
Zenith	5026, 5050, 5051

Remote Control Code List

VCR Codes

Admiral	2131
Adventura	2026
Aiwa	2002, 2026
Akai	2003, 2004, 2111, 2113
American High	2021
Asha	2013
Audio Dynamics	2009, 2010
Audiovox	2014
Bell & Howell	2011
Beaumarck	2013
Calix	2014
Candle	2013, 2014, 2015, 2016, 2017, 2018
Canon	2021, 2022
Carver	2062
CCE	2061
Citizen	2013, 2014, 2015, 2016, 2017, 2018
Colortyme	2009
Colt	2061
Craig	2013, 2014, 2023, 2061
Curtis-Mathes	2000, 2002, 2009, 2013, 2016, 2018, 2021, 2022, 2115
Cybernex	2013
Daewoo	2015, 2017, 2026, 2028
DBX	2009, 2010
Dimensia	2000
Dynatech	2002, 2026
Electrohome	2014, 2029
Electrohome	2014
Emerson	2002, 2014, 2015, 2021, 2026, 2029, 2030, 2032, 2033, 2035, 2036, 2037, 2038, 2039, 2040, 2041, 2042, 2044, 2045, 2065, 2113, 2116, 2117, 2130
Fisher	2011, 2023, 2048, 2049, 2050, 2051, 2118
Fuji	2021, 2119
Funai	2002, 2026
Garrard	2026
GE	2000, 2001, 2013, 2021, 2022, 2053, 2115, 2120
Goldstar	2009, 2014, 2018, 2054, 2121
Gradiente	2026
Harley Davidson	2026
Harman Kardon	2009
Harwood	2061
Headquarter	2011
Hitachi	2002, 2055, 2056, 2057, 2107, 2111, 2120, 2122
Hi-Q	2023
Instant Replay	2021
JCI	2021
JC Penney	2009, 2010, 2011, 2013, 2014, 2021, 2022, 2055, 2056, 2058, 2059, 2060, 2107, 2118
Jensen	2055, 2056, 2111
JVC	2009, 2010, 2011, 2018, 2058, 2111, 2123
Kenwood	2009, 2010, 2011, 2016, 2018, 2058, 2111, 2123
KLH	2061
Kodak	2014, 2021
Lloyd	2002, 2026
Logik	2061
LXI	2014
Magnavox	2021, 2022, 2062, 2063, 2104, 2108, 2124
Magnin	2013
Marantz	2009, 2010, 2011, 2016, 2018, 2021, 2058, 2062
Marta	2014
Masushita	2021
Mei	2021
Memorex	2002, 2011, 2013, 2014, 2021, 2023, 2026, 2104, 2131
MGA	2029, 2065, 2113
MGN Technology	2013
Midland	2053
Minolta	2055, 2056, 2107
Mitsubishi	2029, 2055, 2056, 2065, 2066, 2067, 2069, 2070, 2071, 2072, 2073, 2074, 2106, 2113, 2123
Montgomery Ward	2131
Motorola	2021, 2131
MTC	2002, 2013, 2026
Multitech	2002, 2013, 2016, 2026, 2053, 2061
NEC	2009, 2010, 2011, 2016, 2018, 2058, 2111, 2123
Nikko	2014
Noblix	2013
Olympus	2021
Optimus	2014, 2131
Optonica	2096
Orion	2035
Panasonic	2021, 2022, 2109, 2125, 2126, 2127
Pentax	2016, 2055, 2056, 2107, 2120
Pentax Research	2018
Philco	2021, 2022, 2062, 2063
Philips	2021, 2062, 2096, 2124
Pilot	2014
Pioneer	2010, 2055, 2080, 2081, 2123
Portland	2016, 2017, ,
PROSCAN	2000, 2001
Protec	2061
Pulsar	2104
Quarter	2011
Quartz	2011
Quasar	2021, 2022, 2125
RCA	2000, 2001, 2003, 2013, 2021, 2055, 2056, 2082, 2083, 2084, 2085, 2086, 2087, 2088, 2089, 2090, 2091, 2107, 2115, 2120, 2125
Radioshack/Realistic	2002, 2011, 2013, 2014, 2021, 2022, 2023, 2026, 2029, 2049, 2050, 2096, 2131
Radix	2014
Randex	2014
Ricoh	2128
Runco	2104
Samsung	2013, 2015, 2033, 2053
Sanky	2104, 2131
Sansui	2010, , 2111, 2123
Sanyo	2011, 2013, 2023
Scott	2015, 2032, 2035, 2038, 2065, 2093, 2116
Sears	2011, 2014, 2021, 2023, 2048, 2049, 2050, 2051, 2055, 2056, 2107, 2118
Sharp	2002, 2017, 2029, 2094, 2095, 2096, 2131
Shintom	2004, 2056, 2061, 2098
Shogun	2013
Signature	2002, 2131
Singer	2021, 2061, 2128
Sony	2002, 2004, 2098, 2099, 2119, 2128
STS	2021, 2107
Sylvania	2002, 2021, 2022, 2026, 2062, 2063, 2065, 2124
Symphonic	2002, 2026
Tandy	2002, 2011
Tashiko	2014
Tatung	2058, 2111
Teac	2002, 2026, 2058, 2085, 2111
Technics	2021, 2109
Teknika	2002, 2014, 2021, 2026
TMK	2013
Toshiba	2015, 2049, 2051, 2055, 2065, 2093, 2116
Totevision	2013, 2014
Unitech	2013
Vector Research	2009, 2010, 2015, 2016
Victor	2010
Video Concepts	2009, 2010, 2015, 2016, 2113
Videosonic	2013

Wards	2002, 2013, 2014, 2015, 2021, 2023, 2026, 2029, 2055, 2056, 2061, 2096, 2101, 2102, 2103, 2107, 2116, 2131
XR-1000	2021, 2026, 2061
Yamaha	2009, 2010, 2011, 2018, 2058, 2111
Zenith	2004, 2098, 2104, 2119, 2128

Satellite Receiver Codes

Chapparral	5056, 5057
Drake	5058, 5059
GE	5000, 5001
General Instuments	5060, 5061, 5062
Panasonic	5075
Primestar	5076
PROSCAN	5000, 5001
RCA	5000, 5001
Realistic	5063
Sony	5072
STS1	5064
STS2	5065
STS3	5066
STS4	5067
Toshiba	5068
Toshiba	5073
Uniden	5069

Reference

FCC Registration Information

Your DVD Player is registered with the Federal Communications Commission and is in compliance with parts 15B and 68, FCC Rules and Regulations.

1. Notification to the Local Telephone Company/REN Number

On the bottom of this equipment is a label indicating among other information, the FCC Registration number and Ringer Equivalence Number (REN) for the equipment. You must, upon request, provide this information to your telephone company.

The REN is useful to determine the number of devices you may connect to your telephone line and still have all these devices ring when your telephone number is called. In most (but not all) areas, the sum of the RENs of all devices connected to one line should not exceed 5. To be certain of the number of devices you may connect to your line as determined by the REN, you should contact your local telephone company.

Notes: This equipment may not be used on coin service provided by the telephone company.

Party lines are subject to state tariffs, and therefore, you may not be able to use your own telephone equipment if you are on a party line. Check with your local telephone company.

Notice must be given to the telephone company upon permanent disconnection of your equipment from your line.

2. Rights of the Telephone Company/telephone network information

Should your equipment cause trouble on your line which may harm the telephone network, the telephone company shall, where practicable, notify you that temporary discontinuance of service may be required. Where prior notice is not practicable and the circumstances warrant such action, the telephone company may temporarily discontinue service immediately. In case of such temporary discontinuance, the telephone company must: (1) promptly notify you of such temporary discontinuance (2) afford you the opportunity to correct the situation and (3) inform you of your right to bring a complaint to the Commission pursuant to procedures set forth in Subpart E of Part 68, FCC Rules and Regulations.

The telephone company may make changes in its communications facilities, equipment, operations of procedures where such action is required in the operation of its business and not inconsistent with FCC Rules and Regulations. If these changes are expected to affect the use or performance of your telephone equipment, the telephone company must give you adequate notice, in writing, to allow you to maintain uninterrupted service

Industry Canada Information

NOTICE: the Industry Canada label identifies certified equipment. This certification means that the equipment meets certain telecommunications network protective, operational and safety requirements as prescribed in the appropriate Terminal Equipment Technical Requirements document(s). The Department does not guarantee the equipment will operate to the user's satisfaction.

Before installing this equipment, users should ensure that it is permissible to be connected to the facilities of the local telecommunications company. The equipment must also be installed using an acceptable method of connection. The customer should be aware that compliance with the above conditions may not prevent degradation of service in some situations.

Repairs to certified equipment should be coordinated by a representative designated by the supplier. Any repairs or alterations made by the user to this equipment, or equipment malfunctions, may give the telecommunications company cause to request the user to disconnect the equipment.

Users should ensure for their own protection that the electrical ground connections of the power utility, telephone lines and internal metallic water pipe system, if present, are connected together. This precaution may be particularly important in rural areas.

CAUTION: Users should not attempt to make such connections themselves, but should contact the appropriate electric inspection authority, or electrician, as appropriate.

Accessories and Order Form



Optical Plug to Optical Plug DV3 (3 ft.) DV6 (6 ft.)



Optical Plug to Mini Plug DV3M (3 ft.) DV6M (6 ft.)

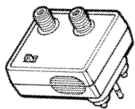

RF Output Adapter (CRF 800)

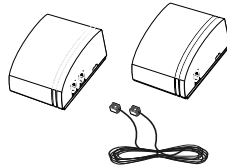

Wireless Phone Jack (D916)

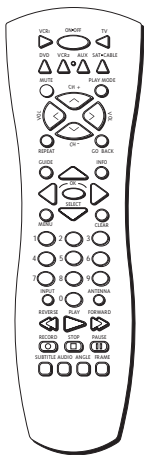

Universal Remote Control (CRK76DA1)

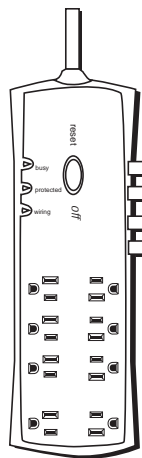

Surge Protector (SCTV160)



Detach Here

Accessory Order Form for Your DVD Player

Description	Part No.	Price	Qty
Optical Plug to Optical Plug (3 ft.)	DV3	\$29.95	
Optical Plug to Optical Plug (6 ft.)	DV6	\$39.95	
Optical Plug to Mini Plug (3 ft.)	DV3M	\$29.95	
Optical Plug to Mini Plug (6 ft.)	DV6M	\$39.95	
RF Output Adapter	CRF 800		
Remote Control (CRK76DA1)	240897	\$29.65	
Surge Protector	SCTV160	\$49.95	
Wireless Phone Jack	D916	\$79.95	
White Telephone Line Cord (25 ft.)	TP226	\$4.95	

Prices are subject to change without notice.

Total Merchandise (\$10 Minimum Order)

Sales Tax

We are required by law to collect the appropriate sales tax for each individual state, country, and locality to which the merchandise is being sent.

Shipping, Handling, and Insurance

Total Amount Enclosed

Use VISA or MasterCard preferably.

Money order or check must be in U.S. currency only.

No COD or CASH.

\$	
\$	
\$	5.00
\$	

All accessories are subject to availability. Where applicable, we will ship a superseding model.

Please complete other side also

Reference

Charge your order on your VISA, MasterCard, or Discover Card by filling in below

USE YOUR CREDIT CARD

IMPORTANT: Copy complete account number from your VISA card



My card expires:

IMPORTANT: Copy complete account number from your MasterCard



Copy Number above your name on MasterCard

My card expires:

IMPORTANT: Copy complete account number from your Discover Card



My card expires:

AUTHORIZED SIGNATURE

(Credit card order will not be processed without signature)

Prices are subject to change without notice.

Print or type your name and address clearly.



A complete and correct order will save you days of waiting.

Name: _____

Street: _____

_____ Apt: _____

City: _____

State: _____ Zip: _____

Please make sure that both sides of this form have been filled out completely.

- Allow 4 weeks for delivery.
- All accessories are subject to availability.
- Prices are subject to change

United States and Canada Orders

To place your order by phone, have your Visa, MasterCard or Discover Card ready and call the toll-free number listed below between 8 AM and 10 PM (EST) Monday through Friday or between 9 AM and 5 PM (EST) Saturday.

Use this number only to place an order for accessory items listed on this order form.

1-800-338-0376

To place your order by mail, detach and mail the completed order form with credit card information, money order or check in US currency (made payable to Thomson Consumer Electronics, Inc.) to the following address:

Video Accessories
PO Box 8419
Ronks, PA 17573

Symbols

- 16 x 9 Widescreen 58
- 4 x 3 Letterbox 58
- 4 x 3 Standard 58

A

- A•B Repeat 25
- AC IN jack 6
- Accessories 89
- Adapter, telephone jack 4
- Additional viewing period 43
- ANGLE button 16, 29
- Angle, camera 29
- Angle icon 83
- ANTENNA button 16
- Arrow buttons 16, 46
- Aspect ratio 58
- Audio
 - Dolby Digital 10, 60
 - DTS 60
 - PCM 60
- AUDIO button 16, 28
- Audio CD
 - loading and playing 64
 - playback features 65
- Audio equipment
 - Dolby Digital 10
 - DTS 10
- Audio Equipment menu 60
- Audio language 28, 55
- Audio R and L jacks 6
- AutoPlay menu 57
- AUX 15

B

- Batteries, remote 4
- Bookmarks
 - clearing 30
 - recalling 30
 - storing 29
 - using 29
- Box, unpack 4
- Buttons
 - ANGLE 16
 - ANTENNA 16
 - Arrow 16
 - AUDIO 16
 - AUX 15
 - CH+ 16
 - CH- 16
 - CLEAR 16
 - DVD 15
 - FORWARD 16
 - FRAME- 17
 - GO BACK 17
 - GUIDE 17
 - INFO 17
 - INPUT 17
 - MENU 17

- MUTE 17
- Numbers (0-9) 17
- OK 17
- ON•OFF 17, 82
- OPEN•CLOSE 82
- PAUSE 17, 82
- PLAY 17, 82
- PLAY MODE 17
- REPEAT 17
- REVERSE 17
- SAT•CABLE 15
- SELECT 17
- SKIP FWD 82
- SKIP REV 82
- STOP 17
- SUBTITLE 17
- TV 15
- VCR 1 15
- VCR 2 15
- Vol 17
- VOLUME 82

C

- Cable box codes 86
 - Camera angle 29
 - Cancelling repeat feature 27
 - CD
 - loading and playing 64
 - using Dub Assist 72
 - CH+ button 16
 - CH- button 16
 - Change Movie Settings 33
 - Changing the Audio Language 55
 - Changing the Menu Language 57
 - Changing your password 51
 - Chapter
 - selecting 24
 - selecting on a Divx disc 35
 - Cleaning discs 78
 - CLEAR button 16, 46
 - Clearing a bookmark 30
 - Closed envelope 36
 - Coaxial cable 8
 - Code list
 - for remote control 87
 - Codes
 - language 62
 - Connecting to Divx 13
 - Connections 7, 8, 9, 10
 - Controls
 - front panel 82
 - remote 15, 16, 17
 - Country menu 52
 - Creating a program 48
 - Crumpled envelope icon 36
 - Customer Service 41
- ## D
- Deleting a program 49
 - Dialing Prefix 40

- DIGITAL AUDIO OUT jack 6, 10
 - Disc
 - loading and playing 20
 - menu 20
 - Disc Guide menu 49
 - Disc menu 21
 - Disc tray 82
 - Discs
 - audio CDs 4
 - cleaning 78
 - digital video discs 20
 - Divx 32
 - handling 78
 - types you can't play 20, 64
 - Display
 - front panel 83
 - Display menu 58
 - Display messages 83
 - Disposing of your player 44
 - Divx
 - account information 44
 - customer service 41
 - register 13
 - Divx discs
 - how to play 32
 - Divx Limits
 - purchases 43
 - ratings limits 42
 - rentals 43
 - setting 42
 - Divx mail
 - erasing a message 37
 - viewing 36
 - Divx menu 61
 - Divx statement
 - detailed 39
 - DivxGold discs 35
 - DivxSilver 34
 - Dolby Digital 10, 11, 60
 - Dolby Pro Logic 10, 11
 - DTS 10, 60
 - Dub Assist 72
 - DVD button 15
 - DVD Limits menu
 - Country 52
 - Rated Titles 53
 - Unrated Titles 54
 - DVD mode 47
- ## E
- Edit Program menu 48
 - Editing a program 49
 - Enter New Password 50
 - Envelope
 - closed 36
 - crumpled 36
 - icon on front panel 83
 - opened 36
 - Erasing a dialing prefix 40
 - Erasing a mail message 37

Index

F

- Fast motion playback 22
- FORWARD button 16
- Frame advance 22
- FRAME- button 17
- Free Access 42
- Freeze frame (pause) 22
- Front Display menu 58
- Front panel controls 82
- Front panel display 83
- Front panel icons
 - angle 83
 - locked 83
 - mail 83
 - play direction 83
 - repeat 83
 - unlocked 83

G

- Glossary 61
- GO BACK button 17, 46
- Go back icon 47
- Grayed out 23, 47
- GUIDE button 17

H

- Handling
 - cautions 78
 - discs 78
 - DVD Player 78
- Headphones jack 82
- Help
 - how to get 79
- Highlight 12, 46
- How to find your TV's video input channel 14
- How to play Divx discs 32

I

- Icons 23
- Important account information 44
- INFO button 17
- Info Display
 - picture of 23
 - using 23
- INPUT button 14, 17
- Installing batteries 4
- Invalid icon 23

J

- Jacks
 - AC IN 6
 - AUDIO OUT R L 6
 - DIGITAL AUDIO OUT 6
 - PHONE JACK 6
 - R and L 6
 - RF ADAPTER 6
 - S-VIDEO 6
 - VIDEO OUT 6

L

- Language
 - changing the menu 57
 - subtitles 56
- Language code list 62
- Language Options 12
- Language Prefs menu 54
- List
 - language codes 62
- Loading a disc
 - audio CD 64
 - digital video disc 20
- Lock Menu 50
- Locked icon 50, 83
- Locking your DVD Player 50

M

- Mail, from Divx 36
- Mail icon 83
- Mail Message
 - erasing 37
 - unerasing 37
- Main menu items
 - Disc Guide 49
 - Divx 61
 - Glossary 61
 - Lock 50
 - Play 48
 - Setup 54
- Maintenance 78
- MENU button 17
- Menu icon 24
- Menu item, grayed out 47
- Menu language 12
- Menus
 - path 46
 - static 46
 - types 46
- Messages
 - front panel 83
 - mail 36
 - specials 38
- Modes, remote control 18, 47, 85
- Motion Pictures Association of America 53
- Movie Settings, changing 33
- Movie Status, viewing 34
- MUTE button 17

N

- Navigation 12, 46
- Number buttons 17

O

- OK button 17, 46
- ON•OFF button 17, 82
- On-screen info display 23, 65
- OPEN•CLOSE button 82
- Opened envelope 36
- Order form, accessories 89

P

- Password 50, 51
- Password Required 42
- Path menu item 46
- PAUSE button 17, 82
- PCM 60
- PHONE JACK 6
- Phone jack splitter 4
- phone line cord 4
- Phone number
 - changing yours 44
 - customer service
 - 1-888-456-DIVX 44
 - Divx registration
 - 1-888-NEW-DIVX 31
- Picture scan 22
- PLAY button 17, 82
- Play direction icon 83
- Play Menu 48
 - program play 48
 - random play 48
 - standard play 48
- PLAY MODE button 17
- Play Modes
 - program 25
 - selecting 25
- Playback features
 - audio CD 65
 - audio language 28
 - bookmarks 29
 - camera angle 29
 - fast motion 22
 - repeat 25
 - selecting a chapter 24
 - selecting play modes 25
 - slow motion 22
 - subtitle language 27
 - using disc menu 24
- Playing
 - CDs 64
 - digital video discs 20
 - Divx discs 32
- Prefix, dialing 40
- Problems 74, 79

Program
 creating 48
 deleting 49, 67
 editing 49
 Programming the remote to control
 components 84
 Purchases 43
 Purchasing Unlimited Play 34

R

R and L jacks 6
 Rated Titles 53
 Rating Limits 42, 52
 Recalling bookmarks 30
 Regional coding 19
 Register with Divx 13
 Remote control
 using to move through menus 46
 Remote control
 code list 87
 component buttons 15
 helpful hints about 18
 modes 85
 other buttons 16
 pointing 18
 Programming 84
 Remote, installing batteries 4
 Rentals 43
 Repeat
 A•B 25
 cancelling 27
 REPEAT button 17
 Repeat icon 83
 Restricting purchases 43
 REVERSE button 17
 RF ADAPTER jack 6
 RF output adapter 8

S

S-VIDEO jack 6
 SAT•CABLE button 15
 Satellite receiver codes 87
 SELECT button 17
 Selecting a chapter 24, 35
 Selecting a Title 23
 Selecting play modes 25
 Service 41
 Setup menu 45, 54
 SKIP FWD button 82
 SKIP REV button 82
 Slow motion playback 22
 Solutions 74, 75, 76
 Sound Logic 59, 60
 Sound menu 59
 Specials Message 38
 Statement 39
 Static menu item 46
 STOP button 17, 82

Storing bookmarks 29
 SUBTITLE button 17
 Subtitle language 27, 56
 System Test menu 60

T

Telephone 13
 Telephone jack splitter 4
 Telephone line cord 4, 36
 Title 23
 Troubleshooting 74, 75, 76
 TV button 15
 TV codes 86
 TV Image menu 58
 TV's Video Input Channel 14
 Types of Discs the Player Can Play 4

U

Unerasing a mail message 37
 Universal remote
 programming to control other brands of
 components 85
 Unlocked icon 50, 83
 Unlocking the player 51
 Unpack the box 4
 Unrated titles 54
 Using bookmarks 29

V

VCR
 connecting it 9
 watching it 9
 VCR codes 87
 VCR1 button 15
 Video Input Channel 7, 13, 14
 VIDEO OUT jack 6
 View Movie Status 34
 Viewing a Divx mail message 36
 Viewing a Specials Message 38
 Viewing your Divx statement 39
 VOL + and - buttons 82
 VOL up and down buttons 17

W

World wide web 31

 **THOMSON CONSUMER ELECTRONICS**

10330 North Meridian Street
Indianapolis, IN 46290

©1998 Thomson Consumer Electronics, Inc.
Trademark(s)® Registered
Marca(s) Registrada(s)
Printed in USA
TOCOM 15398370



100%
RECYCLED PAPER
MINIMUM 40% POST CONSUMER



Free Manuals Download Website

<http://myh66.com>

<http://usermanuals.us>

<http://www.somanuals.com>

<http://www.4manuals.cc>

<http://www.manual-lib.com>

<http://www.404manual.com>

<http://www.luxmanual.com>

<http://aubethermostatmanual.com>

Golf course search by state

<http://golfingnear.com>

Email search by domain

<http://emailbydomain.com>

Auto manuals search

<http://auto.somanuals.com>

TV manuals search

<http://tv.somanuals.com>