



XDVD181

OWNER'S MANUAL

Portable DVD Player with 7" TFT LCD Display



The XDVD181 includes an AC adapter and a DC adapter for use in the home and car environment. Optional universal batteries are available for use with the XDVD181. Contact our consumer hotline @ 1-866-382-5476 for more details.



Table of Contents

	Page
DVD Region Management.....	2
Package Contents.....	3
Safety Information/Precautions.....	4-5
Control Locations - DVD Player	6
Control Locations - Remote.....	7
Connections.....	8
Quick-Start Guide.....	9
DVD Setup Menu	10-12
DVD Operation.....	13-15
CD Operation.....	16
Using the Car Mount	17
Warranty.....	18
Troubleshooting.....	19
Specifications.....	20

DVD Region Management

Some DVD discs can be played only in certain playback modes according to the intentions of the software products. As this player plays discs according to their intentions, some functions may not work as intended by you. Please be sure to read the instructions provided with each disc. This player has been designed to play back the DVD software that has been encoded for specific region areas. It cannot play back the DVD software encoded for other region areas than the region areas for which it has been designed.

The XDVD181 will play discs labeled “region 1” or “all”.



DVD region codes are:

- 1 - USA, Canada
- 2 - Japan, Europe, South Africa, Middle East
- 3 - Asia
- 4 - Australia, New Zealand, Mexico, South America
- 5 - Russia, India
- 6 - China

Package Contents

Please carefully unpack the unit and inspect all contents. The XDVD181 includes the following items:

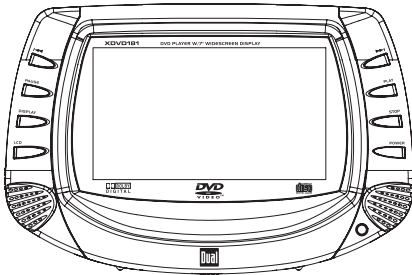

XDVD181 DVD Player with 7" TFT LCD



Remote Control x 1
Coin Battery x 1



AC Adapter x 1



DC Adapter x 1



A/V Output Cable x 1



Earbuds x 2

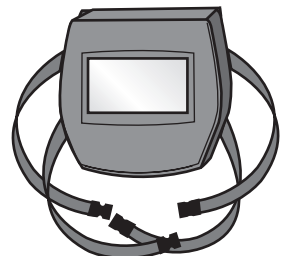

Car Mount x 1



Safety Information

CAUTION: Use of controls or adjustments or performance of procedures other than those specified herein may result in hazardous radiation exposure.

1. Read All Instructions - All safety and operating instructions should be read before attempting to operate this product.
2. Heed Warnings - All warnings on the product and in the operating instructions should be adhered to.
3. Cleaning - Disconnect power from this product before cleaning. Do not use liquid cleaners or aerosol cleaners. To prevent scratches, use only a damp cloth for cleaning LCD screen.
4. Water and Moisture - Do not use this product near water - for example, near a bath tub, sink, in a wet basement, or near a swimming pool.
5. Ventilation - Any slots and openings in the cabinet are provided for ventilation and to ensure reliable operation of the product and to protect it from overheating. These openings must not be blocked or covered. The openings should never be blocked by placing the product on a bed, sofa, rug, or other similar surface.
6. Power Sources - This product should be operated only from the type of power source indicated on the marking label.
7. Polarization - This product may be equipped with a polarized alternating-current line plug (a plug having one blade wider than the other). This plug will fit into the power outlet only one way. This is a safety feature. If you are unable to insert the plug fully into the outlet, try reversing the plug. If the plug should still fail to fit, contact your electrician to replace your obsolete outlet. Do not defeat the safety purpose of the polarized plug.
8. Power Cord Protection - Power supply cords should be routed so that they are not likely to be walked on or pinched by items placed upon or against them, paying particular attention to cords at plugs, convenience receptacles, and the point where they exit from the product.
9. Lightning - For added protection for this product during a lightning storm, or when it is left unattended and unused for long periods of time, unplug it from the wall outlet. This will prevent damage to the product due to lightning and power-line surges.
10. Object and Liquid Entry - Never push objects of any kind into this product through openings as they may touch dangerous voltage points or short-out parts that could result in a fire or electric shock. Never spill liquid of any kind on the product.

Safety Precautions

1. Servicing - Do not attempt to service this product yourself as opening or removing covers may expose you to dangerous voltage or other hazards. Refer all servicing to qualified service personnel.
2. Damage Requiring Service - Unplug this product from the wall outlet and refer servicing to qualified service personnel under the following conditions:
 - a. When the power-supply cord or plug is damaged.
 - b. If liquid has been spilled, or objects have fallen into the product.
 - c. If the product has been exposed to rain or water.
 - d. If the product does not operate normally by following the operating instructions.
 - e. If the product has been dropped or damaged in any way.
 - f. When the product exhibits a distinct change in performance - this may indicate a need for service.
3. Replacement Parts - When replacement parts are required, be sure the service technician has used replacement parts specified by the manufacturer or have the same characteristics as the original part. Unauthorized substitutions may result in fire, electric shock, or other hazards.

This device employs a Laser System. Use of controls or adjustments or performance of procedures other than those specified herein may result in hazardous radiation exposure. Make sure the device is stopped or powered down prior to opening player lid.

CAUTION

TO REDUCE THE RISK OF ELECTRIC SHOCK, DO NOT ATTEMPT TO DISASSEMBLE OR SERVICE THIS UNIT. NO USER-SERVICEABLE PARTS INSIDE. REFER SERVICING TO QUALIFIED SERVICE PERSONNEL ONLY.



This device complies with part 15 of the FCC rules and regulations.

Operation is subject to the following two conditions:

- 1) This device may not cause harmful interference, and
- 2) This device must accept any interference received, including interference that may cause undesired operation.

Control Locations - DVD Player

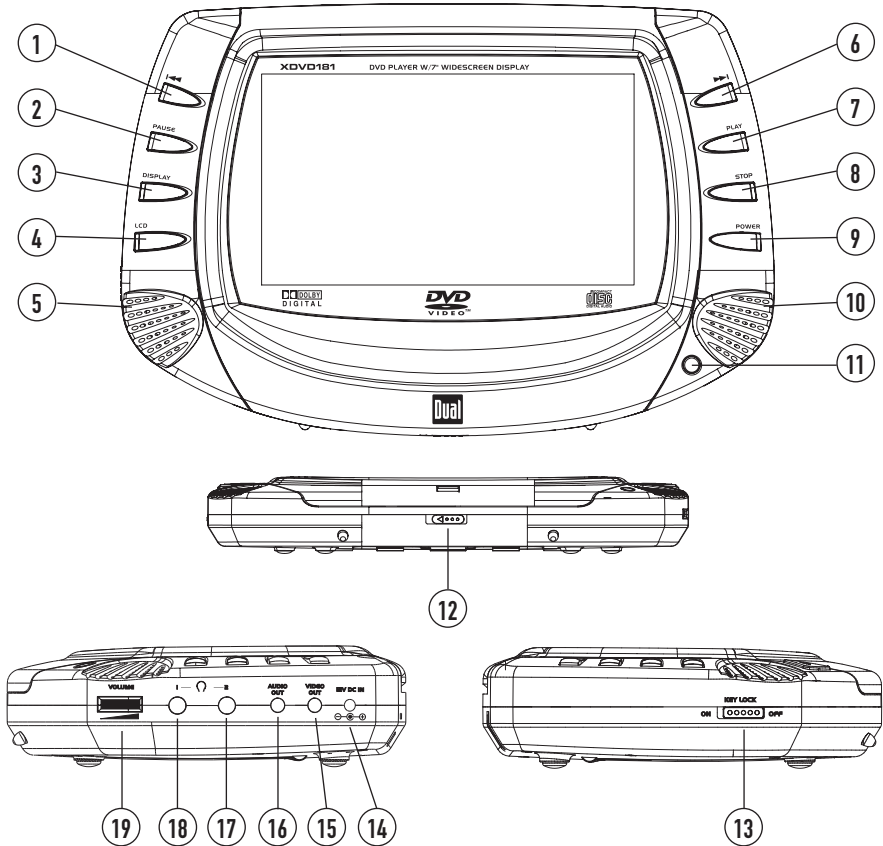

- | | | |
|----------------------|-------------------|-------------------|
| ① Chapter/Track Down | ⑧ Stop | ⑮ Video Out |
| ② Pause | ⑨ Power On/Off | ⑯ Audio Out |
| ③ Display | ⑩ Right Speaker | ⑰ Headphone 2 Out |
| ④ LCD On/Off | ⑪ IR Sensor | ⑱ Headphone 1 Out |
| ⑤ Left Speaker | ⑫ Open | ⑲ Volume |
| ⑥ Chapter/Track Up | ⑬ Key Lock On/Off | |
| ⑦ Play | ⑭ 12VDC Input | |

Control Locations - Remote

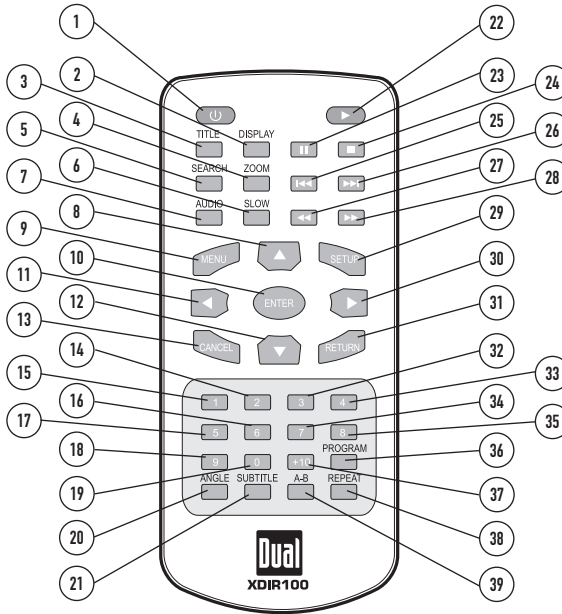

- | | | |
|-----------------|-----------------------|------------------|
| 1 Power | 14 Key #2 | 27 Fast Reverse |
| 2 Display | 15 Key #1 | 28 Fast Forward |
| 3 Title | 16 Key #6 | 29 Setup |
| 4 Zoom | 17 Key #5 | 30 4-Way - Right |
| 5 Search | 18 Key #9 | 31 Return |
| 6 Slow | 19 Key #0 | 32 Key #3 |
| 7 Audio | 20 Angle | 33 Key #4 |
| 8 4-Way - Up | 21 Subtitle | 34 Key #7 |
| 9 Menu | 22 Play | 35 Key #8 |
| 10 Enter | 23 Pause | 36 Program |
| 11 4-Way - Left | 24 Stop | 37 Key #+10 |
| 12 4-Way - Down | 25 Chapter/Track Down | 38 Repeat |
| 13 Cancel | 26 Chapter/Track Up | 39 Repeat A-B |

Connections

Power Connections

Home Use

Connect the supplied AC power adapter to the **12VDC** power connector located on the right side of the unit. Plug the other end into a standard 110 VAC wall outlet.

Car Use

Connect the supplied DC power adapter to the **12VDC** power connector located on the right side of the unit. Plug the other end into a standard vehicle cigarette outlet.

NOTE: Power off the XDVD181 and any other A/V equipment before making any external Audio or Video connections.

Headphone Connections

Connect the supplied headphones to the headphone outputs labeled **1** or **2** located on the right side of the unit. Make sure the volume level is set to its minimum setting before connecting the headphones.

External Audio Connections

Connect the supplied audio cable to the **AUDIO OUT** connector located on the right side of the unit. The audio cable is identified by having a 3.5 mm stereo (3 section) connector on one end and red/white RCA connectors on the other end. Connect the red/white RCA connectors to an audio input on your stereo receiver or TV. Consult your stereo receiver or TV owner's manual for further information.

External Video Connections

Connect the supplied video cable to the **VIDEO OUT** connector located on the right side of the unit. The video cable is identified by having a 3.5 mm mono (2 section) connector on one end and a yellow RCA connector on the other end. Connect the yellow RCA connector to a video input on your TV. Consult your TV owner's manual for further information.



Audio Output Connector (black)



Video Output Connector (yellow)

Quick-Start Guide

Inserting a Disc	<p>Slide the OPEN button to the left and gently lift the lid.</p> <p>The lid opens to a maximum 90 degrees. Do not open it any further - as severe damage may occur.</p> <p>Align the center of the disc with the center of the spindle guide. Press gently down on the center of the disc to snap it into place, then gently close the lid until a click is heard.</p>
Power On	<p>Press the POWER button on the main unit for more than 2 seconds to turn the unit on.</p>
Playback Start	<p>Press the PLAY button. In general, the DVD will start playing automatically when the power is turned on. The DVD player will immediately start rendering the DVD program.</p> <p>“⊗” may appear on the display during operation. “⊗” means that feature or operation is not permitted by the DVD video player at this time.</p>
Playback Stop	<p>Press the STOP button momentarily. The unit will return to the start-up logo.</p>
Power Off	<p>When the unit is on, press POWER for more than 2 seconds to turn the unit off.</p>
Automatic Power Off	<p>The unit will automatically enter screen saver mode (if activated) after approximately 3-1/2 minutes of no activity. The unit will also automatically power off after approximately 10 minutes of no activity.</p> <p>Note: The unit will resume playback from the beginning of the DVD when POWER is turned on.</p>
Using the Remote Control	<p>Remove the clear plastic separator from the battery compartment before using the remote control. When replacing the battery, use only a 3 volt Lithium CR2025 or equivalent.</p> <p>Point the remote at the IR sensor located on the front of the main unit. The operating distance is up to 20' away from the main unit within 60° of the IR sensor.</p>

General Operation - DVD Setup Menu

Access DVD Setup Menu	Using the remote, press SETUP to access DVD setup menu. Press ◀ or ▶ to select between menu pages and ▲/▼/◀/▶ to adjust settings and or levels. When selectable, the menu item will be highlighted in Yellow. The current setting is highlighted in red. Press ENTER to select/confirm each setting.
Exit Setup Menu	Press SETUP to save settings and exit the setup menu. Notes: Some DVD discs can be played only in certain playback modes according to the intentions of the software products. As this player plays discs according to their intentions, some functions may not work as intended by you. Please be sure to read the instructions provided with each disc.
<u>General Setup Page</u>	Press ◀ or ▶ to select General Setup Page and ENTER to select.
TV Display	Press ▲ or ▼ to select display as Normal/PS (Pan & Scan) , Normal/LB (Letterbox) or Wide (Widescreen) . Note: On some DVDs, the TV Display option is only available when the disc the fully stopped. See page 13 for details.
Angle Mark	Press ▲ or ▼ to select On/Off .
OSD Lang (On Screen Display) Language	Press ▲ or ▼ to select ENGLISH, FRENCH or SPANISH OSD (On Screen Display).
Captions (Closed Caption)	Press ▲ or ▼ to select On/Off .
Screen Saver	Press ▲ or ▼ to select On/Off . The unit will automatically enter screen saver mode (if activated and with a disc inside) after approximately 3-1/2 minutes of no activity.

General Operation - DVD Setup Menu

<u>Audio Setup Page</u>	Press ◀ or ▶ to select Audio Setup Page and ENTER to select.
Speaker Setup	Press ▲ or ▼ to select Speaker Setup Page and ENTER to select.
Downmix	Press ▲ or ▼ to select LT/RT or Stereo .
Audio Setup	Press ▲ or ▼ to select Audio Setup and ENTER to select.
Dual Mono	Press ▲ or ▼ to select Stereo , L-Mono , R-Mono , Mix-Mono .
<u>Video Setup Page</u>	Press ◀ or ▶ to select Video Setup Page and ENTER to select.
Sharpness	Press ▲ or ▼ to select High , Medium or Low .
Brightness	Press ◀ or ▶ to adjust brightness level. (range is -20 minimum/+20 maximum)
Contrast	Press ◀ or ▶ to adjust contrast level. (range is -16 minimum/+16 maximum)
Tint	Press ◀ or ▶ to adjust tint level. (range is -9 minimum/+9 maximum)
Color	Press ◀ or ▶ to adjust color level. (range is -9 minimum/+9 maximum)



General Operation - DVD Setup Menu

Preference Page

Press ◀ or ▶ to select **Preference Page** and ENTER to select.

Note:

The DVD must be fully stopped before the **Preference Page** can be accessed. See page 13 for details.

Audio (DVD Title)

Press ▲ or ▼ to select **English, French, German, Spanish, Portuguese, Italian, Danish or Swedish**.

Note:

If the disc has a predetermined language or, recorded in a language not listed above, the audio language setting will not be reflected.

Subtitle (Language)

Press ▲ or ▼ to select **English, French, German, Spanish, Portuguese, Italian, Danish, Swedish or Off**.

Note:

If the disc has a predetermined language or, recorded in a language not listed above, the subtitle language setting will not be reflected.

Disc Menu (Language)

Press ▲ or ▼ to select **English, French, German, Spanish, Portuguese, Italian, Danish or Swedish**.

Note:

If the disc has a predetermined language or, recorded in a language not listed above, the disc menu language setting will not be reflected.

Parental (Control)

Press ▲ or ▼ to select **KID SAF, G, PG, PG 13, PGR, R, NC17, or ADULT**. A password is required to change the parental control setting. See below for details.

**Default
(Restore Factory Settings)**

Press ▲ or ▼ to select **RESET**. Pressing **RESET** will restore all menu selections to their default setting (except for the password).

Password Setup Page

Press ◀ or ▶ to select **Password Setup Page** and ENTER to select.

Change Password

Press ▲ or ▼ to select **CHANGE**, then create a new password.

The default password is **1234**.

General Operation - DVD

Inserting a disc	Open lid; insert disc making sure it snaps securely on the spindle mount. Close lid.
Power On	Press POWER on the main unit for more than 2 seconds to turn the unit on.
Power Off	When the unit is on, press POWER for more than 2 seconds to turn the unit off.
LCD Monitor On/Off	Press LCD on the main unit for more than 2 seconds to turn the LCD monitor on/off. The monitor can be turned off when using the unit with an external video monitor.
Key Lock On/Off	The key lock function is used to prevent accidental operation of the main unit buttons while using the unit in a portable environment. Select Key Lock ON/OFF on the left side of the main unit. NOTE: The remote control operation is not affected by the Key Lock function.
Playback Start	In general, pressing PLAY or ENTER will start disc playback. Some discs will play automatically when the power is turned on. The unit will immediately start rendering the disc program.
Playback Stop	Press STOP momentarily. The unit will return to the start-up logo and display "Press Play Key To Continue". If PLAY is pressed, the unit will resume operation from the last position in memory.
Playback Full Stop	Press STOP two times. The unit will return to the start-up logo and display ■. If PLAY is pressed, the unit will resume operation from the beginning of the disc.
Pause	Press PAUSE to temporarily stop playback. Press PLAY to resume playback.
Chapter Select	Press ▶▶ to skip to the beginning of the next chapter. Press ◀◀ to return to the beginning of the current chapter. Pressing ◀◀ again skips to the beginning of the previous chapter.

General Operation - DVD

Fast Forward and Reverse	Press I◀◀ or ▶▶I from the main unit for more than 2 seconds to fast forward or fast reverse in 2x; 4x; 8x; 16x; 32x modes. Press PLAY to cancel fast forward or fast reverse.
Step (frame-by-frame)	Press ◀◀ or ▶▶ from the remote control to fast forward or fast reverse in 2x; 4x; 8x; 16x; 32x modes. Press PLAY to cancel fast forward or fast reverse.
Slow	Press PAUSE once from the main unit. II will appear in the display. Press PAUSE to show the next frame. III will appear in the display. Press PLAY to cancel. Press SLOW from the remote control to activate slow playback. Slow playback speed includes I▶ 1/2, 1/4, 1/8 and 1/16 in forward and I◀ 1/2, 1/4, 1/8 and 1/16 in reverse. Press PLAY to resume playback. Note: There is no audio output during fast forward or reverse, step and slow modes of DVD playback.
Zoom	Press ZOOM to increase/decrease the image size from 2X, 3X, 4X or 1/2, 1/3, 1/4 size. Press ▲/▼/◀/▶ while zooming to scroll the image.
Repeat	Press REPEAT once to repeat the current chapter. Press REPEAT twice to repeat the current title. Press REPEAT three times repeat the entire disc. Press REPEAT again to cancel repeat function.
Repeat A-B	Press A-B once to set point "A", again to set point "B". The points between "A" and "B" will continually repeat. Press A-B again to cancel repeat A-B.
Main Menu (Root)	Press MENU to select main menu. Press ▲/▼/◀/▶ to select between menu settings and ENTER to select/confirm. Press RETURN to resume playback from the last position.
Title Menu	Press TITLE to show available titles. Press ▲/▼/◀/▶ to select between titles and ENTER to select/confirm. Press RETURN to resume playback from the last position.



General Operation - DVD

<p>Selecting DVD Audio Language</p>	<p>Press AUDIO while playing to switch between available languages.</p>
<p>Selecting DVD Subtitle Language</p>	<p>Press SUBTITLE while playing to switch between available subtitle languages.</p>
<p>Selecting DVD View Angles</p>	<p>Press ANGLE while playing to switch between available viewing angles.</p>
	<p>Notes: The DVD audio language, subtitle language and view angle features are only available when they are included on the disc. The language and subtitle functions may not work with some discs and they may require some time when selecting between them.</p>
<p>Direct Title Access</p>	<p>When the disc is stopped, use 0~9 and 10+ on the remote to enter the desired title.</p>
<p>Direct Chapter Access</p>	<p>When the disc is playing, use 0~9 and 10+ on the remote to enter the desired chapter.</p>
<p>Direct Search Mode</p>	<p>Press SEARCH to access direct search mode. Select the desired search mode using ▲/▼/◀/▶.</p>
<p>Program Mode</p>	<p>Press PROGRAM to access the program mode. Enter the desired Title and Chapter using 0-9 and 10+ on the remote control. Select Start to begin programmed playback. Up to 20 selections can be programmed.</p>
<p>Cancel Program Play</p>	<p>Press CANCEL to stop program play.</p>
<p>Display Status</p>	<p>Press DISPLAY to select between the following:</p> <p>TT --/-- CH ---/--- with elapsed title time TT --/-- CH ---/--- with remaining title time TT --/-- CH ---/--- with elapsed chapter time TT --/-- CH ---/--- with remaining chapter time Display Off</p>
<p>DVD Compatibility</p>	<p>Some DVDs may be incompatible with this unit, depending on media type and recording method. This model does not support DVD-RAM discs.</p>

General Operation - CD

Play	In general, audio discs will play automatically when inserted or the power is turned on.
Stop	Press STOP momentarily. The unit will return to the start-up logo and display "Press Play Key To Continue". If PLAY is pressed, the unit will resume operation from the last position in memory.
Full Stop	Press STOP two times. The unit will return to the start-up logo and display ■. If PLAY is pressed, the unit will resume operation from the beginning of the disc.
Pause	Press PAUSE to temporarily stop playback. Press PLAY to resume playback.
Track Select	Press ►►I to skip to the beginning of the next track. Press I◄◄ to return to the beginning of the previous track.
Fast Forward and Reverse	Press I◄◄ or ►►I from the main unit for more than 2 seconds to fast forward or fast reverse in 2x; 4x; 8x; 16x; 32x modes. Press PLAY to cancel fast forward or fast reverse.
Track Repeat	Press REPEAT once to repeat the current track. Press REPEAT twice to repeat the entire disc. Press REPEAT again to cancel repeat function.
Repeat A-B	Press A-B once to set point "A", again to set point "B". The points between "A" and "B" will continually repeat. Press A-B again to cancel repeat A-B.
Display Status	Press DISPLAY to select between the following: Track --/-- with elapsed track time Track --/-- with remaining track time Track --/-- with elapsed total time Track --/-- with remaining total time Display Off
CD-R/RW Compatibility	Some CD-Rs and CD-RWs may be incompatible with this unit, depending on media type and recording method.

Using the Car Mount

The XDVD181 car mount (included) provides the convenience of mounting the unit to the back of a vehicle's headrest without expensive, permanent modifications.

Note:

Power off the XDVD181 and disconnect any external connections before using the car mount.

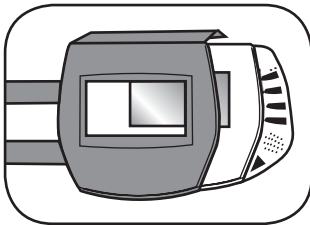

Slip XDVD181 into either side of the car mount.

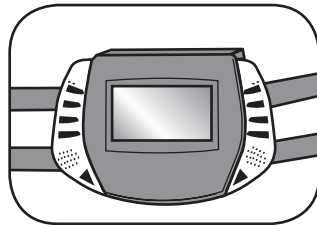

Close top, making sure that Velcro® closure fits snugly. Loop both belts through buckles.

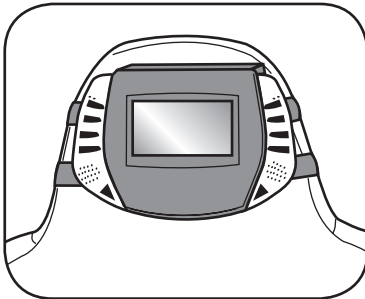

Place both belts over headrest; position unit so that screen is at comfortable viewing level, then tighten belts.

NOTE: Be sure that mounting belts are fastened tightly to hold unit securely in case of sudden stops.

Home Use

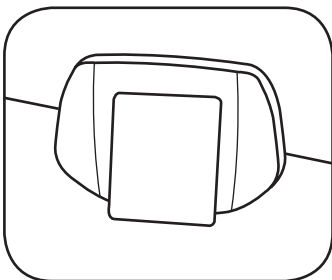

Table Top

The XDVD181 has a built-in easel-style stand to permit viewing in any location in the home. The stand is located on the back of the unit. Place your thumb under the indentation, and pull up. The unit can now be propped on a tabletop or any other solid, even surface.



Limited 30 Day Warranty

This warranty gives you specific legal rights. You may also have other rights which vary from state to state.

Dual Electronics Corp. warrants this product to the original purchaser to be free from defects in material and workmanship for a period of 30 days from the date of the original purchase.

Dual Electronics Corp. agrees, at our option, during the warranty period, to repair any defect in material or workmanship or to furnish an equal new, renewed or comparable product (whichever is deemed necessary) in exchange without charges, subject to verification of the defect or malfunction and proof of the date of purchase. Subsequent replacement products are warranted for the balance of the original warranty period.

Who is covered? This warranty is extended to the original retail purchaser for products purchased and used in the U.S.A.

What is covered? This warranty covers all defects in material and workmanship in this product. The following are not covered: installation/removal costs, damage resulting from accident, misuse, abuse, neglect, product modification, improper installation, incorrect line voltage, unauthorized repair or failure to follow instructions supplied with the product, or damage occurring during return shipment of the product.

What to do?

1. Before you call for service, check the troubleshooting guide in your owner's manual. A slight adjustment of any custom controls or connections discussed in your owner's manual may save you a service call.
2. If you require service during the warranty period, you must carefully pack the product (preferably in the original package) and ship it by prepaid transportation with a copy of the original receipt from the retailer to an authorized service center.
3. Please describe your problem in writing and include your name, a return UPS shipping address (P.O. Box not acceptable), and a daytime phone number with your shipment.
4. For more information and for the location of the nearest authorized service center please contact us by one of the following methods:
 - Call us toll-free at 1-866-382-5476
 - Email us at cs@dualav.com

Exclusion of Certain Damages: This warranty is exclusive and in lieu of any and all other warranties, expressed or implied, including without limitation the implied warranties of merchantability and fitness for a particular purpose and any obligation, liability, right, claim or remedy in contract or tort, whether or not arising from the company's negligence, actual or imputed. No person or representative is authorized to assume for the company any other liability in connection with the sale of this product. In no event shall the company be liable for indirect, incidental or consequential damages.

Troubleshooting

Problem	Action
Unit will not turn on (no power)	Connect the AC adapter into the wall outlet securely. Connect the DC adapter into the vehicle cigarette outlet securely. Press the POWER button on the main unit for more than 2 seconds.
Unit has power (but no picture)	Check the connections from the DVD video output to the TV or A/V receiver video input. Make sure your TV or A/V receiver is set to the correct mode. Refer to your TV or A/V receiver owners manual. Make sure the Key Lock function is set to OFF. Make sure the LCD monitor is turned on. Press and hold the LCD button for 2 seconds to turn the LCD monitor on/off.
Unit has power (but no sound)	Check the connections from the DVD audio output to the TV or A/V receiver audio input. Make sure your TV or A/V receiver is set to the correct mode. Refer to your TV or A/V receiver owners manual. Increase volume control on unit. Unplug the headphones to hear sound from the built-in speakers.
Picture has occasional distortion	A small amount of picture distortion may appear because of a poor quality video/sound transfer to disc.
Brightness is unstable or noises are produced when playing	Physical defect in media. Check media for scratches. Connect the DVD player directly to the TV and not through any other source. Avoid connecting the unit to a VCR or TV/VCR combination.
The DVD does not start playback	Disc is loaded upside down. Place the disc in the unit with the graphics side up. Place the disc on the disc spindle correctly inside the unit. Make sure the disc is free from scratches and fingerprints. Press the SETUP button to turn off the menu screen. Cancel the parental lock function or change the parental lock level. (The default password is 1234.) Turn the power off then disconnect the power plug and reconnect. Use discs labeled "Region 1" or "All" only.
The unit turns off by itself	This is a function of the unit by design. As a safety feature, the main unit will automatically power off after approx. 10 minutes of no activity.
The remote control does not work properly	Remove and discard the clear plastic separator from the battery compartment of the remote control. Check for obstructions in front of the IR sensor on the main unit. Replace the battery.

Copyright Notes

This product incorporates copyright protection technology that is protected by method claims of certain U.S. patents and other intellectual property rights owned by Macrovision Corporation and other rights owners. Use of this copyright protection technology must be authorized by Macrovision Corporation, and is intended for home and other limited viewing uses only unless otherwise authorized by Macrovision Corporation. Reverse engineering or disassembly is prohibited.

Manufactured under license from Dolby Laboratories. "Dolby" and the double-D symbol are trademarks of Dolby Laboratories.

Confidential unpublished works. ©1992-1997 Dolby Laboratories, Inc. All rights reserved.



Specifications

DVD Player	Signal-to-noise: >94db Dynamic range: >95db Harmonic distortion: <0.008% Frequency response: 10Hz-20kHz Channel separation @1kHz: >68dB D/A converter: 24 Bit Sampling frequencies: 44.1kHz, 48kHz, 96kHz Electronic Shock Protection: 3 seconds (DVD) 20 seconds (CD)
Monitor	Panel size: 7" (177.8 mm) diagonal measurement Format: Widescreen 16:9 Display system: Transparent TFT LCD panel Resolution: 1440 x 234 Elements: 336,960 Backlighting: CCFL
General	Operating voltage: 12VDC Operating current: 2A Audio line output voltage: >1.75V RMS Video system: NTSC Main unit dimensions: 10.62" W x 7.02" H x 1.68" D (270 x 178 x 43 mm)

Design and specifications subject to change without notice.

Free Manuals Download Website

<http://myh66.com>

<http://usermanuals.us>

<http://www.somanuals.com>

<http://www.4manuals.cc>

<http://www.manual-lib.com>

<http://www.404manual.com>

<http://www.luxmanual.com>

<http://aubethermostatmanual.com>

Golf course search by state

<http://golfingnear.com>

Email search by domain

<http://emailbydomain.com>

Auto manuals search

<http://auto.somanuals.com>

TV manuals search

<http://tv.somanuals.com>