

IMPORTANT INFORMATION

WARNING

To reduce the risk of fire or electric shock, do not expose this product to rain or moisture.

CAUTION

RISK OF ELECTRIC SHOCK. DO NOT OPEN

Caution: To reduce the risk of electric shock, do not remove cover (or back). No user-serviceable parts inside. Refer servicing to qualified service personnel.



This symbol indicates "dangerous voltage" inside the product that presents a risk of electric shock or personal injury.



This symbol indicates important instructions accompanying the product.

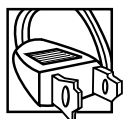

Caution: To prevent electric shock, match wide blade of plug to wide slot, fully insert.

Attention: Pour éviter les chocs électriques, introduire la lame la plus large de la fiche dans la borne correspondante de la prise et pousser jusqu'au fond.

Refer to the identification/rating label located on the back panel of your product for its proper operating voltage.

FCC Regulations state that unauthorized changes or modifications to this equipment may void the user's authority to operate it.

Caution: Using video games or any external accessory with fixed images for extended periods of time can cause them to be permanently imprinted on the picture tube (or projection TV picture tubes). ALSO, some network/program logos, phone numbers, etc. may cause similar damage. This damage is not covered by your warranty.

Cable TV Installer: This reminder is provided to call your attention to Article 820-40 of the National Electrical Code (Section 54 of the Canadian Electrical Code, Part 1) which provides guidelines for proper grounding and, in particular, specifies that the cable ground shall be connected to the grounding system of the building as close to the point of cable entry as practical.

Product Registration

Please fill out the product registration card (packed separately) and return it immediately. Returning the card allows us to contact you if needed.

Product Information

Keep your sales receipt to obtain warranty parts and service and for proof of purchase. Attach it here and record the serial and model numbers in case you need them. These numbers are located on the product.

Model No. _____

Serial No. _____

Purchase Date: _____

Dealer/Address/Phone: _____

G-LINK, VCR Plus+, C³, PlusCode, GUIDE Plus+ and GUIDE Plus+ Gold are trademarks of Gemstar Development Corporation.

The VCR Plus+ and GUIDE Plus+ systems are manufactured under license from Gemstar Development Corporation and VCR Index Systems B.V., respectively.

VCR required for recording.

THOMSON MULTIMEDIA INC. AND GEMSTAR ARE NOT IN ANY WAY LIABLE FOR THE ACCURACY OF THE PROGRAM INFORMATION PROVIDED BY THE GUIDE PLUS+ SYSTEM. IN NO EVENT SHALL THOMSON MULTIMEDIA INC. OR GEMSTAR BE LIABLE FOR ANY AMOUNT REPRESENTING LOSS OF PROFITS, LOSS OF BUSINESS, OR INDIRECT, SPECIAL, OR CONSEQUENTIAL DAMAGES IN CONNECTION WITH THE PROVISION OR USE OF ANY INFORMATION, EQUIPMENT, OR SERVICES RELATING TO THE GUIDE PLUS+ SYSTEM.

TABLE OF CONTENTS

SETUP AND CONNECTIONS	3
Step 1: Unpack the TV	4
Step 2: Connect your TV	4
TV Only	4
The Basic Connection	5
Advanced Connections	6
Step 3: Connect the G-LINK Cable	9
How to Find the Remote Control Sensor	9
Step 4: Plug in the TV	10
Step 5: Place Batteries in the Remote	10
Step 6: Turn on the TV	10
On-Screen Program Guide	10
Step 7: Program the TV	10
INTERACTIVE SETUP	11
Using Point and Select	12
Entering Setup	12
Select a Language	13
Auto Channel Search	13
The GUIDE Plus+ System	14
Setting Up the GUIDE Plus+ System	14
Setting the Time	16
Setting the VCR1 Channel (auto tuning)	16
Setting the VCR2 Channel (auto tuning)	17
Setting the DVD Channel (auto tuning)	18
Setting the SAT/CABLE Channel (auto tuning)	19
Labeling the Channels	20
USING THE REMOTE	21
Remote Buttons	22
Accessing the Video Input	23
Programming the Remote	24
Testing the Remote	24
Using Automatic Code Search	24
Using the Remote to Control a Component	25
Modes of Operation	25
Front Panel	25
FEATURES AND MENUS	27
Menus and Control Panels	28
Menus	28
Control Panels	28

TABLE OF CONTENTS

Audio Menu	29
Using the Remote to Select an Audio Processor	30
Picture Quality Menu	30
Screen Menu	31
Using Closed Captioning	31
Adjusting the Color Projection Tubes	32
Advanced Convergence	33
Channel Menu	33
Time Menu	35
Setup Menu	35
Parental Controls and V-Chip	36
How V-Chip Works	36
V-Chip TV Rating Limit	37
V-Chip Movie Rating Limit	41
V-Chip Unrated Program Block	42
Channel Block	42
Front Panel Block	42
Lock/Unlock Parental Controls	42
About the GUIDE Plus+ System	43
Downloading Data	43
Grid Guide	44
Sort	46
News	47
Schedule	47
Messages	48
Channels	49
Setup	50
How to Get More Information About an Advertisement or a Program	50
PIP (Picture-in-Picture) Operation	50
Channel Marker	52
GUIDE Plus+ Menu Items	52
REFERENCE	53
Troubleshooting	53
Care and Cleaning	55
Limited Warranty	56
Accessory Information	58
Index	61

SETUP AND CONNECTIONS

GETTING STARTED

This manual is designed to get you started quickly. The first four sections of the manual show you how to get your TV Set Up and Connected, run the Interactive Setup, Program the Remote, and use all of the Features and Menus of your TV.

The Reference section in the back of the book contains troubleshooting tips, care and cleaning instructions, accessory ordering information and your warranty.

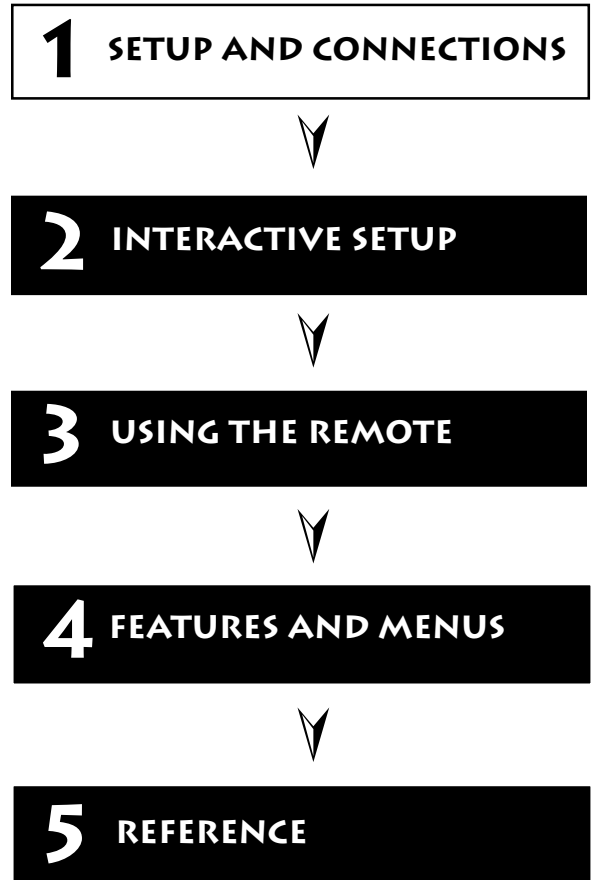

Check out the notes that have been added throughout the manual in these Tip Boxes. There are some important tips that will help you get the most from your TV.

SETUP AND CONNECTIONS

STEP 1: UNPACK THE TV

Make sure to locate the remote control.

STEP 2: CONNECT YOUR TV

There are three types of connections outlined in this section:

TV Only: If you're only going to connect the TV to your home antenna or cable system.

The Basic Connection: If you're going to connect the TV to a VCR or satellite receiver.

Advanced Connections: If you're going to make multiple connections, hooking up the TV to one or two VCRs, DVD player, and a satellite receiver.

Cable information and illustrations are given for each type of connection. Once you have completed your desired connection you may skip forward to Step 3.

Before You Connect

Protect against power surges:

- Connect all components before plugging any power cords into the wall outlet.
- Turn off the TV and/or component before connecting or disconnecting any cables.
- Make sure all antennas and cables are properly grounded. Refer to the Safety Tips sheet packed with your TV.

TV ONLY

This is a basic connection from an antenna or cable system to your TV. Connect the cable into the Cable/Antenna jack as shown.

Cables

You will use the following cable to make your connection:



Coaxial Cable: These cables carry audio and video signal to the TV from an antenna, cable, or cable box.

CABLE, CABLE BOX, OR ANTENNA

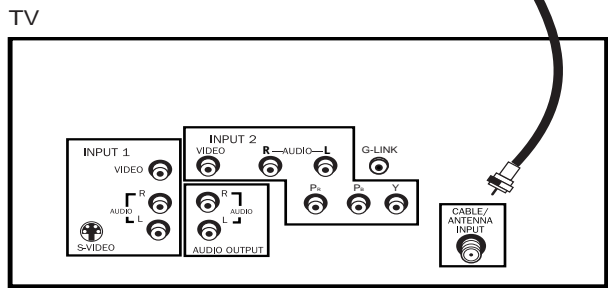

Once you have completed this connection go to "Step 3: Connect the G-LINK Cable" on page 9.

SETUP AND CONNECTIONS

THE BASIC CONNECTION

The basic connection below (TV and VCR) is the most common connection and is therefore used to illustrate a single component connection with your TV. For better sound and picture quality and multiple component connection information refer to the next section, *Advanced Connections*.

Cables



You will use the following cable to make your connection:

Coaxial Cables: These cables carry both the audio and video signal to the TV from an antenna, cable, or cable box. In this connection, a second Coaxial Cable carries the signal through the VCR to the TV.

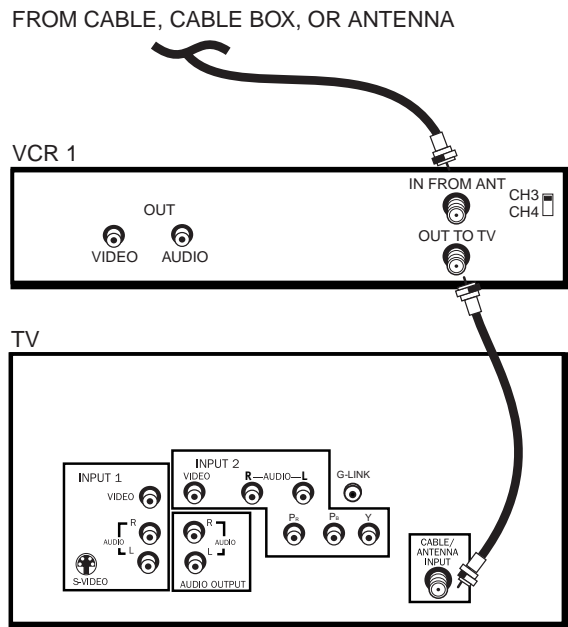

How to View the VCR

To watch the VCR in this connection tune TV to Channel 3 or 4.

Later, in the *Interactive Setup* section you will program the TV to automatically tune to Channel 3 or 4 when you turn on the VCR.

Once you have completed this connection go to "Step 3: Connect the G-LINK Cable" on page 9.

SETUP AND CONNECTIONS

ADVANCED CONNECTIONS

Advanced connections give you better sound and video by separating the audio and video signals and enable you to connect multiple components.

This section describes the types of inputs available on the back of your TV and suggests ways you can use them for optimum performance.

Once you have made your connections you will want to program the TV to tune to the correct Video INPUT channel in order to see and hear audio and video from the component. You will program this later in the *Interactive Setup*.

Back of the TV

The diagram below describes each of the back panel jacks. When connecting A/V cables, be sure to connect corresponding OUTPUTS and INPUTS (Video to Video, Right Audio to Right Audio, etc.).

Input 1

Connect any of the following components:

- VCR
- Laserdisc Player
- Satellite Receiver
- Internet Access Device
- DVD Player

To view the component connected to Input 1: Use the WHO•INPUT button on the remote.

Input 2 (VIDEO or Y P_B P_R)

Connect any of the following components to INPUT 2:

- VCR
- Laserdisc Player
- Satellite Receiver
- Internet Access Device
- DVD Player

The Y, P_B, P_R jacks are used in place of the VIDEO jack to connect an optional component video source, such as a DVD player. Unlike a single video input, the Y, P_B, P_R jacks maintain the video signal as three separate signals through these three jacks. To ensure maximum picture quality, use three video-grade cables for the Y, P_B, and P_R connections.

To View the component connected to Input 2: Use the WHO•INPUT button on the remote.

S-Video

This optional connection can be used for better video quality.

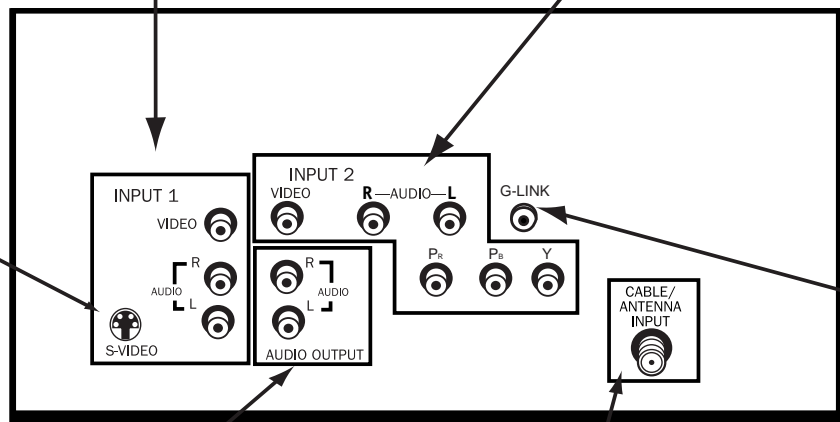

Audio Outputs

Connect to an audio receiver or amplifier for variable controlled or fixed level stereo output.

Cable/Antenna

Takes the signal input from a cable, cable box, or an off-air antenna. Can also be used for basic component connections.

G-LINK

Connect the G-LINK cable for one-button recording and channel tuning from the Guide.

SETUP AND CONNECTIONS

Sample Connections

The following are sample connection scenarios which you may encounter when connecting components to your TV.

Cables

You will use the following cable to make your connection:



Coaxial Cables: Carries the signal from the antenna or cable directly to the television or through a cable box, as needed by your cable system.



Audio/Video Cables: Carries sound and video from the component to the TV.



S-Video Cable: Carries video from an S-Video capable component which provides best picture quality.

TV and Stereo VCR

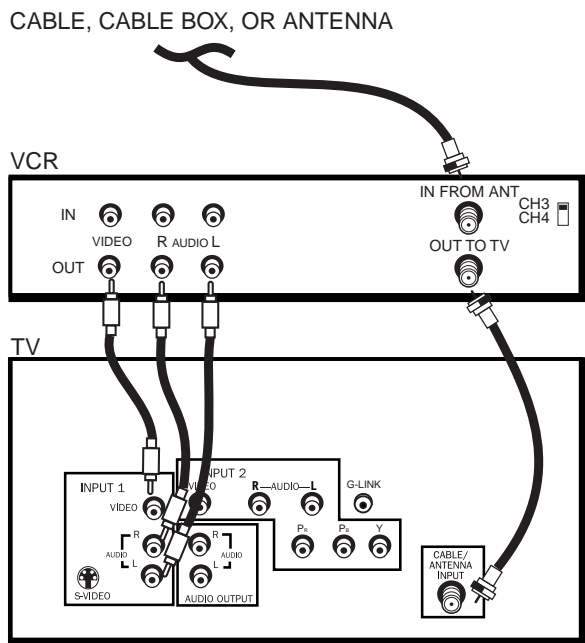

Once you have completed this connection go to "Step 3: Connect the G-LINK Cable" on page 9.

Cautions:

Position cables to Avoid Audio Hum or Interference

- Insert all cables firmly into jacks.
- Place the audio/video cables to the sides of the TV's back panel instead of straight down the middle.
- Try not to coil any twin-lead cables and keep them away from the audio/video cables.

Protect your components from Overheating

- Do not block ventilation holes in any of the components. Arrange the components so that air can circulate freely.
- Do not stack components.
- Allow adequate ventilation when placing your components in a stand.
- Place an amplifier on the top shelf of the stand so heated air rising from it will not flow around other components.

How to View Your VCR

To watch the VCR in this connection, press TV to put the remote control into TV mode, then press WHO•INPUT to scroll through the video input channels until you tune to VID1 input.

In the *Interactive Setup* section you can program the TV to automatically tune to the VID1 input channel when you press VCR1 on the remote.

Most Audio/Video cables are combined into one cable with three heads on each end.

We show individual cables in these sample connections. Either may be used, but you must be sure to connect Video to Video, Right to Right and Left to Left.

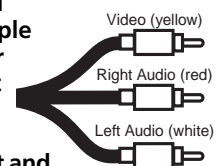

SETUP AND CONNECTIONS

TV, VCR and Satellite Receiver

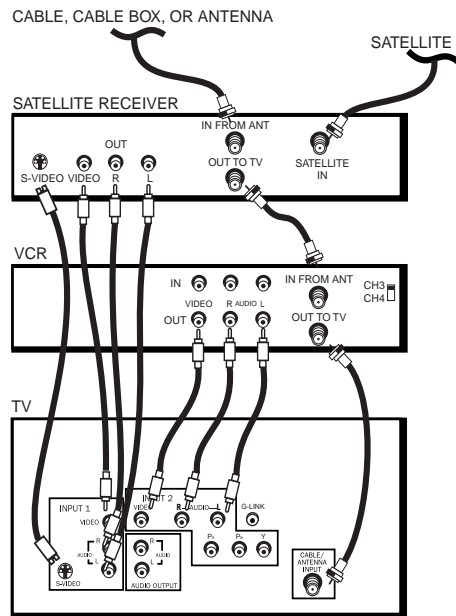

Once you have completed this connection go to "Step 3: Connect the G-LINK Cable" on page 9.

How to View Your Components

To watch the Satellite Receiver in this connection, press TV to put the remote control into TV mode, then press WHO•INPUT to scroll through the video input channels until you tune to VID1 (or SVID 1) input.

To watch the VCR in this connection, press TV to put the remote control into TV mode, then press WHO•INPUT to scroll through the video input channels until you tune to VID2 (or COMP2 if connected to Y, P_B, P_R) input.

In the *Interactive Setup* you can program the TV to automatically tune to the correct input channel when you press the component button on the remote.

TV, VCR, Satellite Receiver and DVD

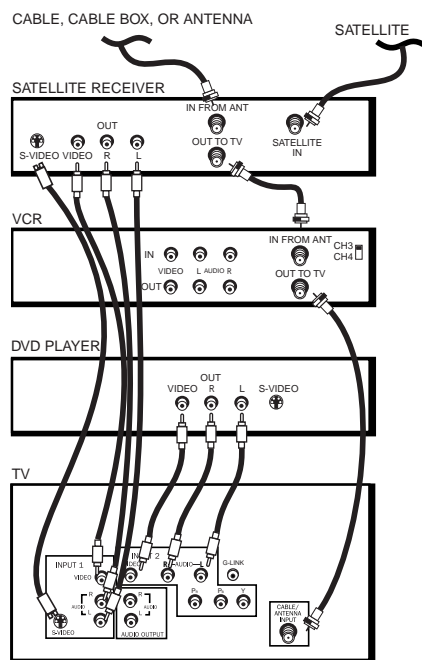

How to View Your Components

To watch the Satellite Receiver in this connection, press TV to put the remote control into TV mode, then press WHO•INPUT to scroll through the video input channels until you tune to VID1 (or SVID 1) input.

To watch the VCR in this connection tune to Channel 3 or 4.

To watch the DVD player in this connection, press TV to put the remote control into TV mode, then press WHO•INPUT to scroll through the video input channels until you tune to VID2 (or COMP2 if connected to Y, P_B, P_R) input.

In the *Interactive Setup* you can program the TV to automatically tune to the correct input channel when you press the component button on the remote.

Once you have completed this connection go to "Step 3: Connect the G-LINK Cable" on page 9.

SETUP AND CONNECTIONS

STEP 3: CONNECT THE G-LINK CABLE

The G-LINK cable enables the GUIDE Plus+ system (the on-screen guide that lists what shows are on TV) to work with your VCR and/or cable box.

Cable Box – If your TV is connected to a cable box and you don't connect the G-LINK cable, no channels will be listed in the on-screen program guide.

VCR – If your TV is connected to a VCR and you don't connect the G-LINK cable, one-touch recording won't work. The other features of the guide will work properly.

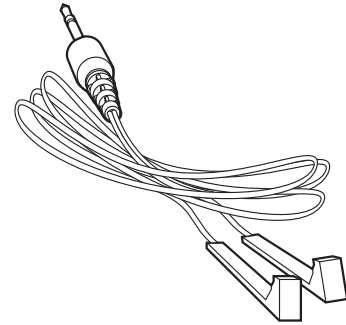

The G-LINK cable is used to send commands to your VCR and/or cable box.

If there is a demo pin in the G-LINK jack, you must remove it before you connect the G-LINK cable. If there is no demo pin, just insert the G-LINK cable into the G-LINK jack.

HOW TO FIND THE REMOTE CONTROL SENSOR

You have to place the G-LINK wands in front of the remote control sensor on the VCR and/or cable box. Some cable boxes and VCRs have the remote control sensor labeled on the unit. If the remote sensor isn't labeled on your VCR and/or cable box, you need to use the remote control that came with the VCR and/or cable box to locate the sensor.

1. Turn off the VCR and/or cable box.
2. Hold the remote control (**not** the one that came with your TV, but the one that came with the cable box and/or VCR to which you're connecting the G-LINK cable) so it is touching the front of the component.
3. Slowly move the remote control across the front of the component (VCR or cable box) while you press the power button on and off. You must press and release the power button each time you move the remote (holding down the button won't work).

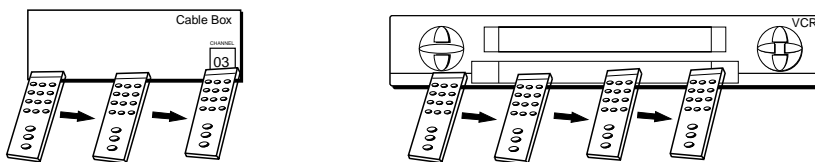

4. When the component turns on, you've located the remote control sensor.
5. Place the wands of the G-LINK cable underneath your VCR and/or cable box (see instructions on right).

Placing the Wands Under the VCR and/or Cable Box

Place the wands of the G-LINK cable underneath your VCR and/or cable box. Place them about one inch away from the remote control sensor.

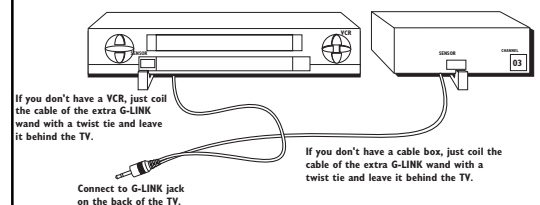

SETUP AND CONNECTIONS

STEP 4: PLUG IN THE TV

Plug the end into the wall outlet, matching the wide blade of the plug with the wide slot in the outlet. Be sure to insert the plug completely.

STEP 5: PLACE BATTERIES IN THE REMOTE

- Remove the battery compartment cover from the back of the remote.
- Insert fresh batteries. Make sure that the polarities (+ and -) are aligned correctly.
- Replace the cover.

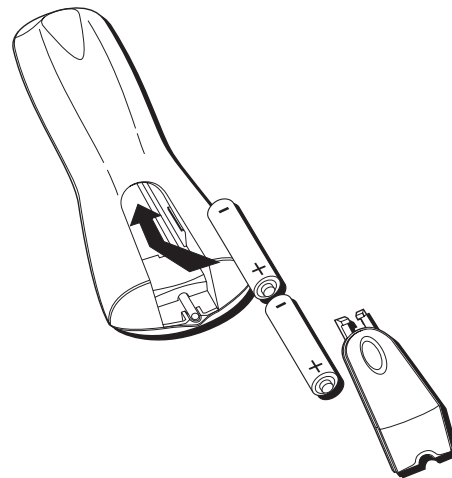

STEP 6: TURN ON THE TV

Press TV on the remote, or press POWER on the TV itself.

Pressing the TV button not only turns on the TV, but puts the remote into TV mode, so that the buttons on the remote will control TV functions.

ON-SCREEN PROGRAM GUIDE

The TV is designed to bring up the GUIDE Plus+ on-screen program guide when you use the TV button on the remote to turn on the TV (after you have set up the GUIDE Plus+ system). For more information, see "GUIDE Plus+ system" on page 43.

To get out of the Guide:

- Press OK to exit the Guide and tune to the highlighted channel.
- Press GUIDE to exit the Guide and tune to the channel displayed in the View window.
- Press CLEAR to exit the Guide and go to the last channel you were watching.

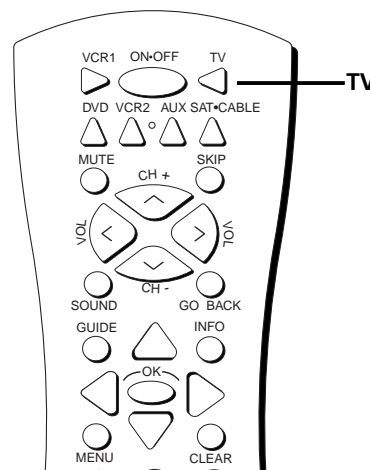

STEP 7: PROGRAM THE TV

Proceed to the next section, *Interactive Setup*. The interactive setup routine walks you through the steps needed to fully configure the TV. The first steps ask you to select your preferred language for the menu system and to begin the auto channel search, which puts available cable TV or antenna signals into the TV's memory.

Picture Quality

If the picture appears to have a double or triple image or if you notice rings or halos around objects, you may have to adjust the color convergence. Details can be found under the Screen menu heading in the *Features and Menus* section of this manual.

INTERACTIVE SETUP

THERE'S AN ON-SCREEN SETUP ROUTINE

The interactive setup routine takes you through the steps needed to configure the TV:

- Select a menu language
- Search for available channels
- Set up the GUIDE Plus+ system
- Set the time
- Set the VCR1 channel
- Set the VCR2 channel
- Set the DVD channel
- Set the SAT/CABLE channel
- Make the channel list and labels

1 SETUP AND CONNECTIONS



2 INTERACTIVE SETUP



3 USING THE REMOTE



4 FEATURES AND MENUS



5 REFERENCE

INTERACTIVE SETUP

USING POINT AND SELECT

You only need to know one rule when using the remote to access on-screen menus and control panels: point and select. The point and select method has two steps.

- 1. Point** to a menu item using the arrow buttons on the remote.
To point up or down, press the up or down arrows. To point left or right, press the left or right arrows.
- 2. Select** a menu item by pressing MENU or OK.
Selecting an item tells the TV's menu system to go ahead and make the change or go to a place you have indicated.

ENTERING SETUP

The first screen of the Interactive Setup appears automatically when you turn on your TV for the first time or after a power outage.

1. Press MENU to begin setup or CLEAR to exit.

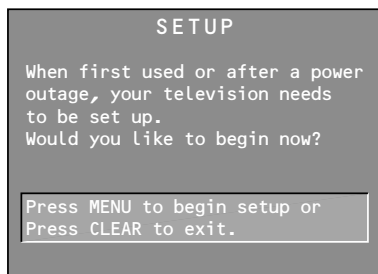

You can also access the Interactive Setup through the Main menu:

1. Press MENU to bring up the Main menu.

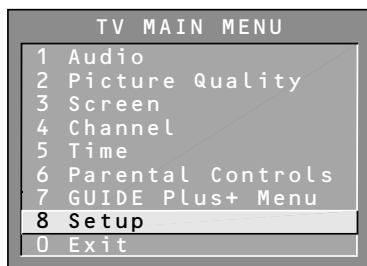

2. Point to *Setup* and press MENU or OK. The first Setup screen comes up, asking you to confirm that you want to begin.

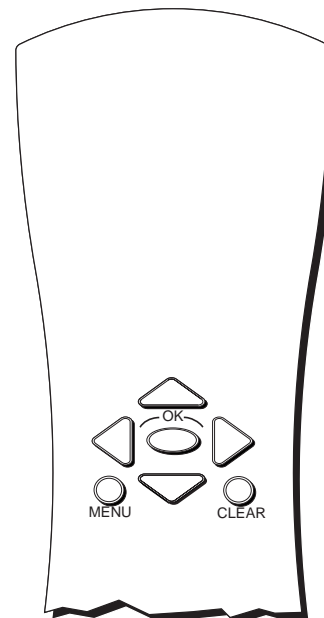

Point and Select buttons

You can also select a menu item by entering the item number with the number buttons on the remote. Press CLEAR at any time to remove all displays from the screen and return to TV viewing.

INTERACTIVE SETUP

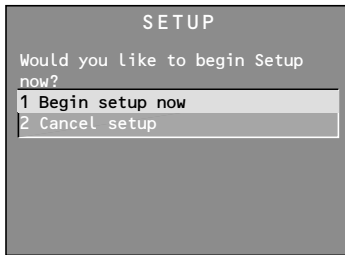

3. Point to *Begin setup now* and press MENU or OK.

SELECT A LANGUAGE

The first part of the setup routine asks you to select your preferred language for the menu system.



1. Point to your preferred language for the menu system.
2. Press MENU or OK to select that language.

AUTO CHANNEL SEARCH

The next part of the setup routine asks you if you want the TV to search automatically for all channels available through your antenna or cable TV system. This is sometimes called "autoprogramming."

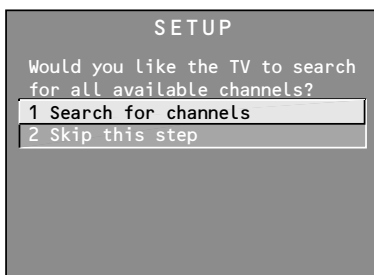

1. Press MENU or OK to tell the TV to begin searching for channels. The display gives you a progress report and tells you when it has finished.
2. Press MENU or OK to continue.

If you skip Auto Channel Search now, you can access it later through the Channel menu. You can also put channels in memory manually using List & Labels. See *Features and Menus* for more details.

INTERACTIVE SETUP

THE GUIDE Plus+ SYSTEM

The next step lets you set up the GUIDE Plus+ system to display your local program listings, and control your cable box and VCR.

You can either press MENU or OK to bring up the GUIDE Plus+ initial menu or point to *Skip this Step* to move to the next step in the Interactive Setup.

You can set up the GUIDE Plus+ system during Interactive Setup. You can also access the GUIDE Plus+ menus by pressing menu on the remote, and selecting GUIDE Plus+ Menu.

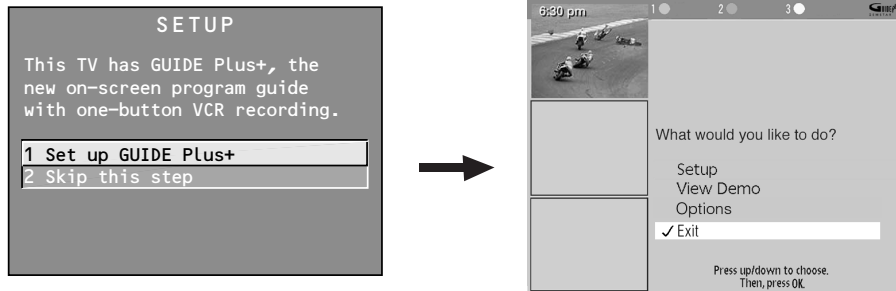

SETTING UP THE GUIDE Plus+ SYSTEM

To complete the GUIDE Plus+ setup, the G-LINK wands must be properly aligned with your cable box and VCR if you have them. Refer to the *Setup and Connections* section for additional information.

Select your Country and enter your ZIP or Postal code.

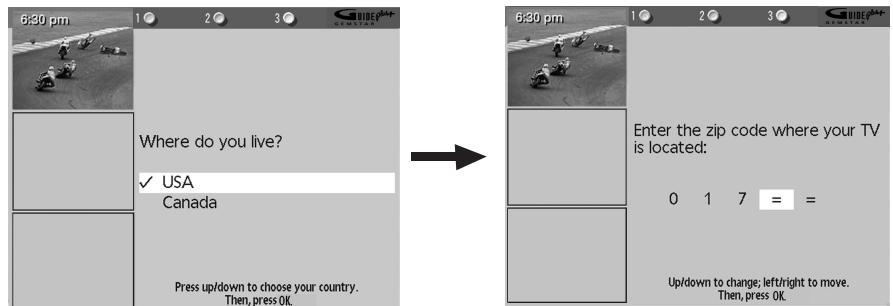

The next series of screens asks you about your cable TV setup. If you have a cable box, you need to set the GUIDE Plus+ system to control it. Otherwise, it may not be able to locate and download program information.

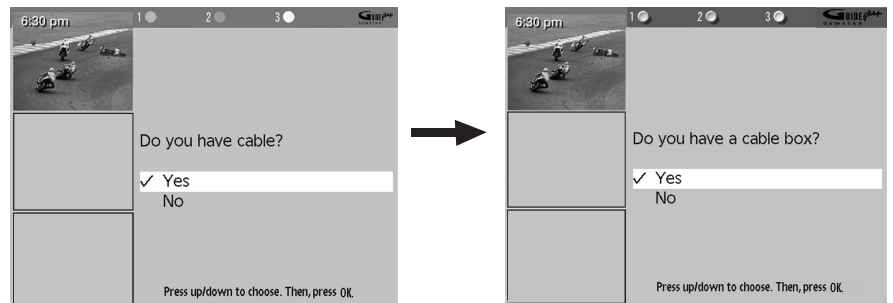

Tune your cable box to Channel 2 and then select the brand of your cable box from the choices available. The system then searches for the correct code to control your cable box. When your cable box switches to channel 9 it has located the correct code.

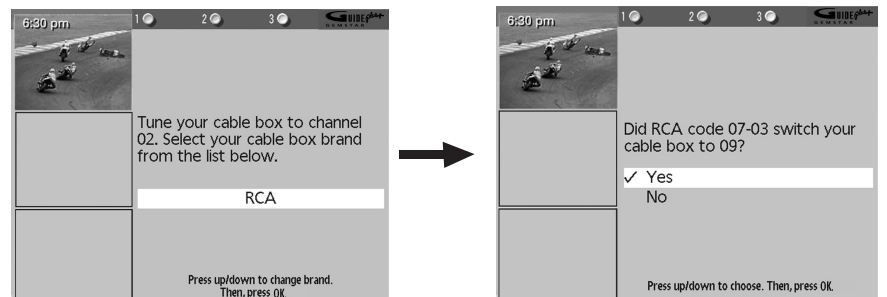

INTERACTIVE SETUP

Select *Yes* if the cable box changed to channel 9, or *No* if it did not. If you select *No*, the system will try another code.

If the GUIDE Plus+ system cannot recognize either your cable box or VCR after several tries, a screen stating "Cable Box (VCR) test failed...Please consult your manual and try again" appears. You have a choice to either *Try Again* or *Skip Cable Box Setup*. If you get this message, you should also:

- Double check the brand of your cable box or VCR, and try entering it again.
- Check to make sure the G-LINK wands are positioned correctly. See the *Setup and Connections* section of this manual for more details.

If you choose to skip the cable box (or VCR) setup some features of the guide may not be available until you successfully complete this procedure.

Once the correct model of cable box has been identified, you need to set the cable box's output channel. Enter the channel you use to view channels through your cable box—usually 3 or 4. Consult your cable box's instruction book or your cable company if you are not sure. Choose 0 to use VIDEO INPUT.

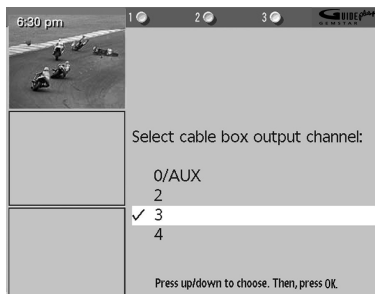

Select *YES* if you have a VCR, or *NO* if not. (Answering *NO* automatically skips forward to the end of GUIDE Plus+ setup.) Tune your VCR to channel 2 and turn it off. Enter the brand of your VCR.

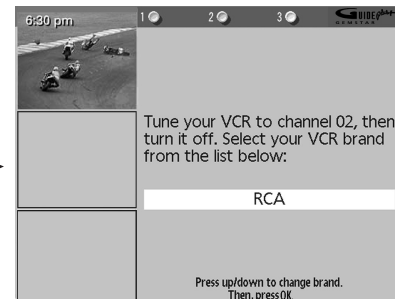
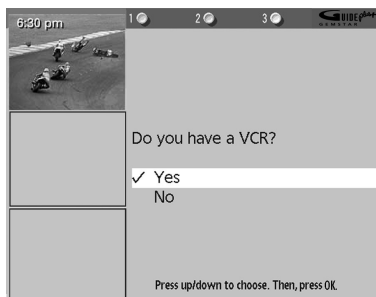

When the GUIDE Plus+ system correctly identifies the correct code for your VCR, the VCR's tuner changes to channel 9. Select *YES* if the VCR automatically changed to channel 9, or *NO* if it did not. If you select *NO*, the system will try another code.

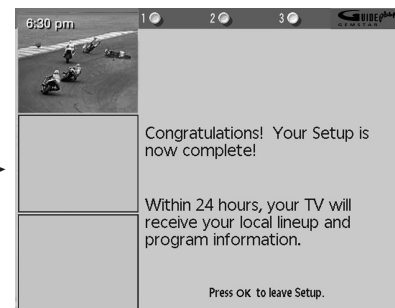
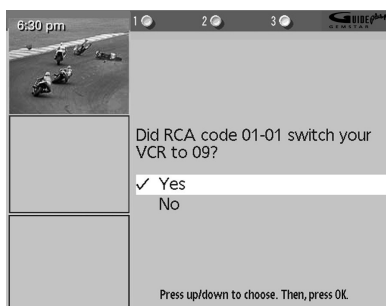

The last screen that comes up after you've successfully finished the GUIDE Plus+ setup gives you an opportunity to view a demo. If you don't want to view the demo, highlight EXIT and press OK.

Remember:

- Leave your cable box turned ON to download program information.
- Leave your VCR turned OFF to record programs and download program information.

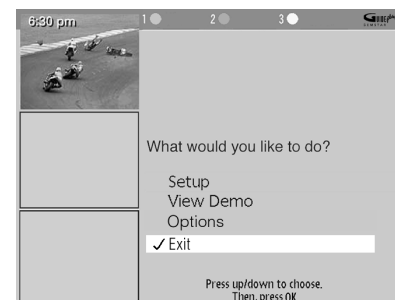

INTERACTIVE SETUP

SETTING THE TIME

The next step in the Interactive Setup lets you set the time of day. If your GUIDE Plus+ system has not completed its first download, you need to set the time.

Once the system has completed its first download, it sets the time for you automatically and you may not see this screen.

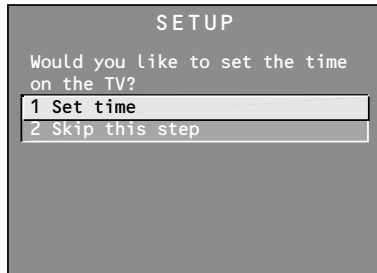

1. Press MENU or OK to bring up the *SET TIME* control panel.

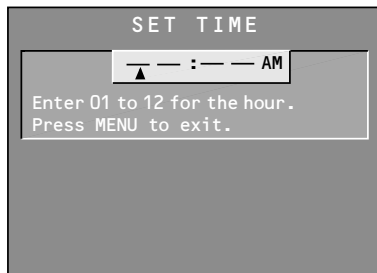

2. Use the left and right arrows to point to the hour and minutes spaces. Use the digits to enter the numbers and the up and down arrows to change from AM to PM.
3. Press MENU or OK to continue.

SETTING THE VCR1 CHANNEL (AUTO TUNING)

The next step lets you set the VCR1 channel. When you set the VCR1 channel, you're telling the TV what channel to tune to when you press the VCR1 button on the remote. This is called auto tuning.

Indicate which input you used to connect the VCR. If you don't have a VCR1 component connected to the TV, skip this step or select *Not Connected* from the VCR1 Channel choice list. (For more, see Auto Tuning in the *Features and Menus* section.)

INTERACTIVE SETUP

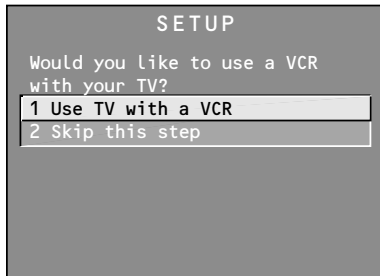

1. Press MENU or OK to bring up the VCR1 choice list.

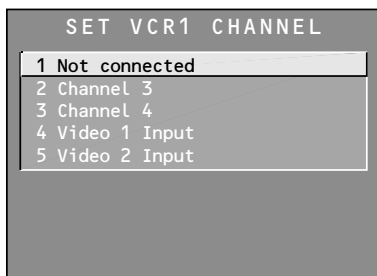

2. Point to the choice that matches the way you have your VCR connected to the TV. If you used audio/video cables, choose the video input you connected the cables to.
3. Press MENU or OK to continue.

SETTING THE VCR2 CHANNEL (AUTO TUNING)

The next step lets you set the VCR2 channel. When you set the VCR2 channel, you're telling the TV what channel to tune to when you press the VCR2 button on the remote.

Indicate which input you used to connect a second VCR. If you don't have a second VCR component connected to the TV, skip this step or select *Not Connected* from the VCR2 Channel choice list. (For more information see Auto Tuning in the *Features and Menus* section.)

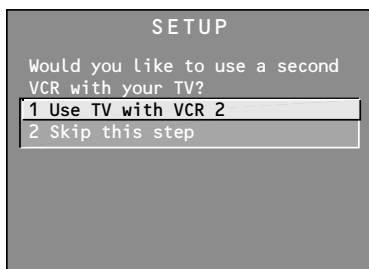

1. Press MENU or OK to bring up the VCR2 choice list.

INTERACTIVE SETUP

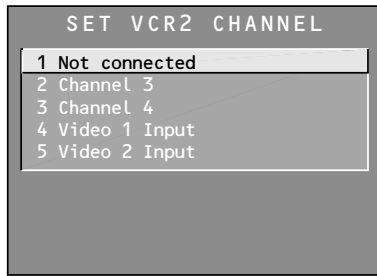

2. Point to the choice that matches the way you have your second VCR connected to the TV. If you used audio/video cables, choose the video input you connected the cables to.
3. Press MENU or OK to continue.

SETTING THE DVD CHANNEL (AUTO TUNING)

The next step lets you set the DVD channel. When you set the DVD channel, you're telling the TV what channel to tune to when you press the DVD button on the remote.

Indicate which input you used to connect a DVD player. If you don't have a DVD player connected to the TV, skip this step or select *Not Connected* from the DVD Channel choice list. (For more, see Auto Tuning in the *Features and Menus* section.)

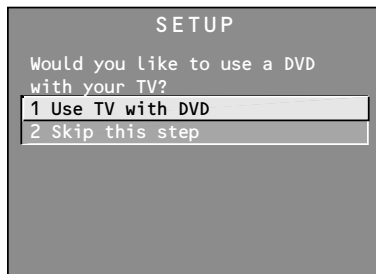

1. Press MENU or OK to bring up the DVD choice list.



2. Point to the choice that matches the way you have your DVD player connected to the TV. If you used audio/video cables, choose the video input you connected the cables to.
3. Press MENU or OK to continue.

INTERACTIVE SETUP

SETTING THE SAT/CABLE CHANNEL (AUTO TUNING)

The next step lets you set the SAT/CABLE channel. When you set the SAT/CABLE channel, you're telling the TV what channel to tune to when you press the SAT•CABLE button on the remote.

Indicate which input you used to connect a satellite receiver or a cable box. If you don't have a satellite receiver or cable box connected to the TV, skip this step or select *Not Connected* from the SAT/CABLE Channel choice list. (For more information see Auto Tuning in the *Features and Menus* section.)

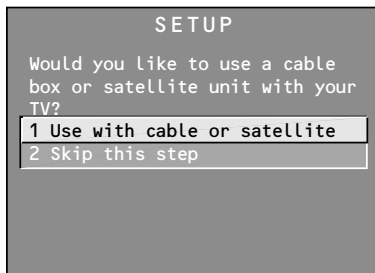

1. Press MENU or OK to bring up the SAT/CABLE choice list.

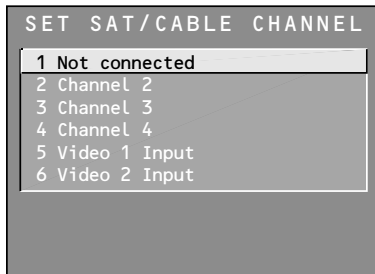

2. Point to the choice that matches the way you have your satellite receiver or cable box connected to the TV. If you used audio/video cables, choose the video input you connected the cables to.
3. Press MENU or OK to continue.

If You Have Both a Satellite Receiver and a Cable Box Connected to the TV

The remote cannot control both a cable box and the satellite receiver. If you choose to have the remote control the satellite receiver, you must then use your cable box remote to control the cable box. You may, however, prefer to use the satellite receiver remote for satellite programming, and set your SAT•CABLE button to control your cable box. It's your choice.

INTERACTIVE SETUP

LABELING THE CHANNELS

This last step in the Interactive Setup lets you edit your channel list and label your channels. (For more information see List and Labels in the *Features and Menus* section.)

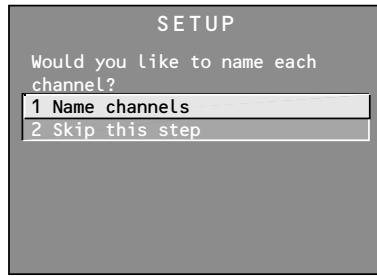

1. Press MENU or OK to bring up the *List and Labels* control panel.

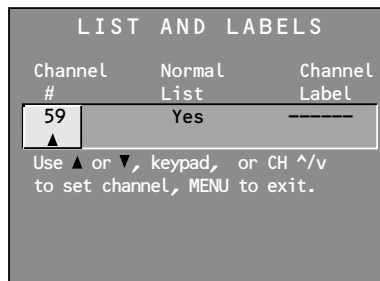

2. Use the left and right arrows to point to the three different areas of the control panel (called "fields").
3. Use the up and down arrows to scroll through the numbers in the *Channel #* field, and letters in the *Channel Label* field, and select *Yes* or *No* in the *Normal List* field. You may wish to refer to the call letters listed in your newspaper's TV section for ideas on labeling the channels.
4. Repeat this process for each of your channels. Then press MENU or OK to continue. The TV can store up to 27 labels in memory.

Use the CH ^ (channel up) or CH v (channel down) buttons to change channels in the Channel # field. This works even if you're not in the Channel # field. Or, enter the channel number directly using the number buttons on the universal remote. To enter a number greater than 99, press and hold "1" to enter the hundreds digit, then press the two remaining numbers.

The *List and Labels* feature can also be accessed from the Channel menu. Because this procedure can be time consuming, feel free to skip this step and come back to it later.

USING THE REMOTE

HOW TO USE YOUR UNIVERSAL REMOTE

This section defines the buttons of the remote and how to program it to control other components.

The universal remote can be programmed to control most brands of remote controllable VCRs, satellite receivers and cable boxes. If you have a RCA, GE or Proscan component, you probably don't need to program it at all.

1 SETUP AND CONNECTIONS



2 INTERACTIVE SETUP



3 USING THE REMOTE



4 FEATURES AND MENUS



5 REFERENCE

Modes of Operation

Because this universal remote can control several different components (DVD player, VCR, Cable Box, etc.) it uses operational modes triggered by the component buttons. For example if you want the remote to control the TV, you would press the TV button to put the remote into TV mode before you could control the TV.

USING THE REMOTE

REMOTE BUTTONS

(0-9) Number Buttons Enters channel numbers and time settings directly through the remote control. To enter a two-digit channel, press the two digits. To enter a three-digit channel, press and hold the first digit until #-- appears, then add the second two. Example: to tune to channel 123, press and hold 1 until 1-- appears then press 2 and 3.

Arrow buttons (up, down, left, right) Used to point to different items in the menu system. Also used to adjust the menu controls. Also moves the PIP window when no menus are on the screen.

ANTENNA Functions as TV/VCR button in VCR mode and TV/receiver button in SAT•CABLE mode.

AUX Puts the remote in AUX mode. Also turns on the TV, if auto tune is enabled.

CH (up and down) buttons Scans up or down through the current channel list. Press once to change the channel up or down; press and hold to continue changing channels.

CH CTRL Selects the picture window, (that is, the main or PIP window) to be changed by the CH ^ (channel up) or CH v (channel down) buttons.

CLEAR Removes any menu or display from the screen and returns you to TV viewing.

DVD Puts the remote in DVD mode to operate RCA, GE, and Proscan DVD players. It cannot be programmed. If autotuning is enabled, it will turn on the TV and tune to the correct channel.

FORWARD If you're operating a VCR or DVD Player with the remote control, press FORWARD to advance a disc or videotape.

GO BACK Returns you to the previous channel.

GUIDE Brings up GUIDE Plus+ system; press again to exit.

INFO Press to get more information about a program, channel, or advertisement.

L.E.D. The little light below the ON•OFF button that lights when you are programming the remote. It also lights when you press an invalid button on the remote.

MENU Brings up the Main menu and selects highlighted items. When in VCR mode, it functions as a PROGRAM button.

MUTE Reduces the TV's volume to its minimum level. Press again to restore the volume.

OK When in the menu system, selects highlighted items or returns you to the previous menu.

ON•OFF When in TV mode, turns TV on and off. If in another mode (VCR, DVD, Satellite, etc.) and programmed, will turn the component on and off. When pressed twice within two seconds all components that are on will be turned off (this feature only works with most RCA, GE and Proscan products).

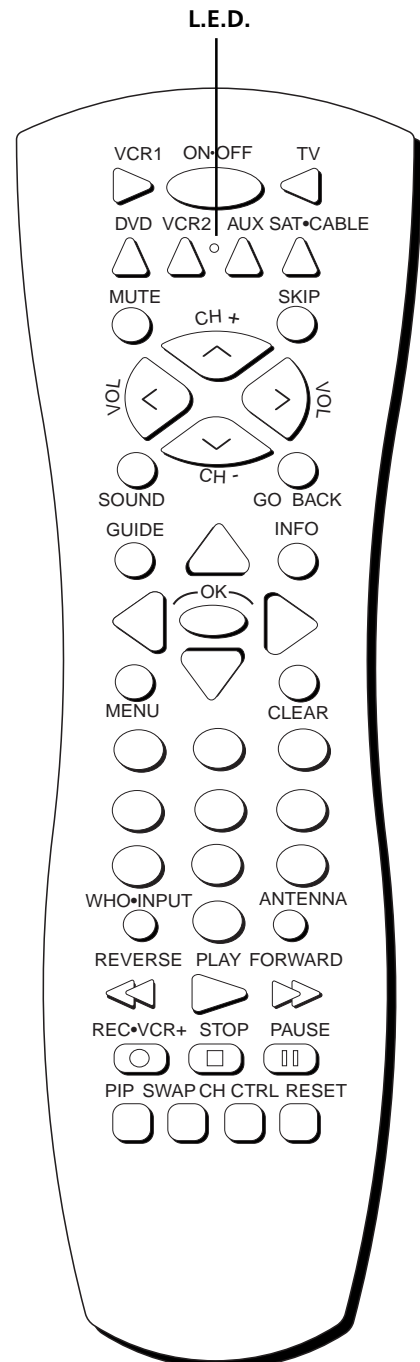

USING THE REMOTE

PAUSE If you're operating a VCR or DVD Player with the remote control, press PAUSE when the disc or videotape is playing to pause playback.

PIP (Picture-In-Picture) Brings up the small picture-in-picture window. Press again to remove the PIP window.

PLAY If you're operating a VCR or DVD Player, plays the disc or videotape.

REC•VCR+ In TV mode, when the GUIDE Plus+ program guide is on the screen, press REC•VCR+ to program your VCR to record a program.

RESET Resets picture quality controls to the *Bright Lighting* Picture Control Preset. Point and select to choose a different Picture Control Preset.

REVERSE If you're operating a VCR or DVD Player, press REVERSE to go backwards on a video tape or disc.

SAT•CABLE Puts the remote in SAT•CABLE mode and if auto tuning is enabled, it will turn on the TV and tune to the correct channel.

SKIP Press once before changing channels and the TV will wait 30 seconds before returning you to the original channel. Press repeatedly to add more time.

SOUND Press once to display the audio processor choice list. Point and select to choose a different processor or press CLEAR to exit.

STOP If you're operating a VCR or DVD Player, press to stop playing the videotape or disc.

SWAP Swaps the main picture with the PIP window.

TV Turns on the TV and puts the remote in TV mode. Also displays channel information.

VCR1 Puts the remote in VCR mode and if auto tuning is enabled, it will turn on the TV and tune to the correct channel.

VCR2 Puts the remote in VCR2 mode and if auto tuning is enabled, it will turn on the TV and tune to the correct channel.

VOL – or VOL + Decreases or increases the TV's volume.

WHO•INPUT In TV mode, press to toggle through the available input sources (VID1/SVID1, VID2/COMP2, and previous channel). In SAT mode, press to select available channel lists for RCA, GE and Proscan satellite receivers.

ACCESSING THE VIDEO INPUT

Use the WHO•INPUT button to scroll through the available input channels and view components you have connected to the TV.

1. Press TV to place the remote in TV mode. Make sure that the component you want to view is turned ON.
2. Press WHO•INPUT to tune to an available input channel.
3. Continue to press the WHO•INPUT button to scroll through the channels.

USING THE REMOTE

PROGRAMMING THE REMOTE

The universal remote can be programmed to control most brands of remote controllable VCRs, satellite receivers and cable boxes. The remote is already programmed to control most RCA, GE and Proscan TVs, VCRs, DVD players, laserdisc players and satellite receivers.

TESTING THE REMOTE

To determine whether the universal remote needs to be programmed, turn a component ON, such as a VCR, point the remote at the VCR, and press the VCR1 button. Then press POWER or CH ^ (channel up) or CH v (channel down) to see if the VCR responds to the remote commands. If not, the remote needs to be programmed.

USING AUTOMATIC CODE SEARCH

The following instructions can be used to program the remote to control each of the components connected to your TV. If you want to exit the automatic code search without programming any of your components, press CLEAR until the LED turns off.

1. Turn on the component you want to control (VCR, SAT, etc.)
2. Point the remote at the component to be controlled. Press and hold the button you want to program (VCR1, VCR2, etc.). While holding the component button, press and hold ON•OFF until the light on the remote turns on, then release both buttons. For the AUX button, using code search will not work, you must use direct entry.
3. Press and release PLAY, then wait 5 seconds or until the LED stops flashing.

At this point the remote is searching for the correct code to program. If, after 5 seconds, the component you want to control does not turn off, press PLAY again to tell the remote to search the next set of codes.

Continue pressing PLAY until the component turns off or you have searched through all of the codes. There are 20 total sets of codes. If the component does not turn off after pressing PLAY 20 times, then the remote cannot control that particular component.

If the component you want to control *does* turn off:

1. Press and release REVERSE, then wait 2 seconds. Repeat this step until the component turns back ON.
2. To finish, press and hold STOP until the light on the remote turns off.

Using Direct Entry

1. Turn on the component to be programmed.
2. Look up the brand and code number(s) for the component on the code list on the last page of this section, *Using the Remote*.
3. Press and hold the button on the remote you want to program.

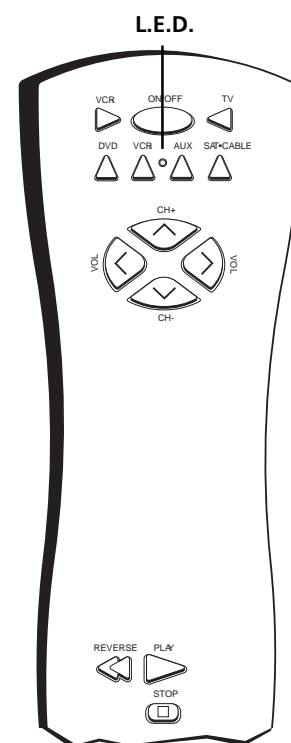

You'll use these buttons when you program the remote to control any device.

The remote may not operate all models of all brands.

USING THE REMOTE

4. Enter the code from the code list.
5. Release button, and then press ON•OFF to see if the component responds to the remote commands. If it doesn't, try pressing the component button and then ON•OFF again.
6. If you get no response, repeat these steps using the next code listed for your brand, until the component responds to the remote commands.

USING THE REMOTE TO CONTROL A COMPONENT

Once the remote has been programmed successfully, you are ready to use it to control your components.

To operate the component:

1. Press the component button (VCR1, VCR2, AUX, or SAT•CABLE) to set the remote to control the component.
2. Press ON•OFF to turn the component ON or OFF.
3. Use the remote buttons that apply to that component.

MODES OF OPERATION

Because this universal remote can control several different components (DVD player, VCR, Cable Box, etc.) it uses operational modes triggered by the component buttons. For example if you want the remote to control the TV, you would press the TV button to put the remote into TV mode before you could control the TV.

FRONT PANEL

If you cannot locate your remote you can use the front panel of your TV to operate many of the TV's features.

MENU Brings up the Main menu. When in the menu system, it selects highlighted items.

CH v Scans down through the current channel list. In the menu system, it points down to items and adjusts menu controls.

CH ^ Scans up through the channel list. In the menu system, it points up to items and adjusts menu controls.

VOL – Decreases the volume. When in the menu system, VOL – is used to point left to items and adjust menu controls.

VOL + Increases the volume. When in the menu system, VOL + is used to point right to items and adjust menu controls.

POWER Turns the TV on and off.

The Front Panel Block feature disables all front panel buttons. For more information, see "Parental Controls," in the *Features and Menus* section.

USING THE REMOTE

VCR

Admiral	2131
Adventura	2026
Aiko	2027
Aiwa	2002, 2026
Akai	2003, 2004, 2005, 2007, 2008, 2111, 2112, 2113
American High	2021
Asha	2013
Audio Dynamics	2009, 2010
Audiovox	2014
Bell & Howell	2011
Beaumarck	2013
Broksonic	2012, 2025
Calix	2014
Candle	2013, 2014, 2015, 2016, 2017, 2018, 2019
Canon	2021, 2022, 2114
Caphehart	2020, 2110
Carver	2062
CCE	2027, 2061
Citizen	2013, 2014, 2015, 2016, 2017, 2018, 2019, 2027
Colortyme	2009
Colt	2061
Craig	2013, 2014, 2023, 2061
Curtis-Mathes	2000, 2002, 2009, 2013, 2016, 2018
.....	2021, 2022, 2024, 2115
Cybernex	2013
Daewoo	2015, 2017, 2019, 2025, 2026, 2027, 2028,
.....	2110
Daytron	2110
Dbx	2009, 2010
Dimensia	2000
Dynatech	2002, 2026
Electrohome	2014, 2029
Electrohome	2014
Emerson	2002, 2012, 2014, 2015, 2021, 2024, 2025
.....	2026, 2029, 2030, 2032, 2033, 2034, 2035, 2036, 2037
.....	2038, 2039, 2040, 2041, 2042, 2044, 2045, 2047, 2065
.....	2105, 2113, 2116, 2117, 2130
Fisher	2011, 2023, 2048, 2049, 2050, 2051, 2052, 2118
Fuji	2021, 2119
Funai	2002, 2026
Garrard	2026
GE	2000, 2001, 2013, 2021, 2022, 2053, 2115, 2120
Goldstar	2009, 2014, 2018, 2054, 2121
Gradiente	2026
Harley Davidson	2026
Harman Kardon	2009
Harwood	2061
Headquarter	2011
Hitachi	2002, 2055, 2056, 2057, 2107, 2111, 2120, 2122
HI-Q	2023
Instant Replay	2021
JCL	2021
JC Penney	2009, 2010, 2011, 2013, 2014, 2021,
.....	2022, 2055, 2056, 2058, 2059, 2060, 2107, 2118
Jensen	2055, 2056, 2111
JVC	2009, 2010, 2011, 2018, 2058, 2111, 2123
Kenwood	2009, 2010, 2011, 2016, 2018, 2058,
.....	2111, 2123
KLH	2061
Kodak	2014, 2021
Lloyd	2002, 2026
Logik	2061
LXI	2014
Magnavox	2021, 2022, 2062, 2063, 2104, 2108, 2124
Magnin	2013
Marantz	2009, 2010, 2011, 2016, 2018, 2021, 2058
.....	2062, 2064
Marta	2014
Masushita	2021
MEI	2021
Memorex	2002, 2011, 2013, 2014, 2021, 2023, 2026
.....	2104, 2131
MGA	2029, 2065, 2113
MGN Technology	2013
Midland	2053
Minolta	2055, 2056, 2107
Mitsubishi	2029, 2055, 2056, 2065, 2066, 2067, 2069,
.....	2070, 2071, 2072, 2073, 2074, 2106, 2113, 2123
Montgomery Ward	2075, 2131
Motorola	2021, 2131

MTC	2002, 2013, 2026
Multitech	2002, 2013, 2016, 2026, 2053, 2061
NEC	2009, 2010, 2011, 2016, 2018, 2058, 2064, 2076
.....	2078, 2079, 2111, 2123
Nikko	2014
Noblex	2013
Olympus	2021
Optimus	2014, 2131
Optonica	2096
Orion	2035
Panasonic	2021, 2022, 2109, 2125, 2126, 2127
Pentax	2016, 2055, 2056, 2107, 2120
Pentax Research	2018
Philco	2021, 2022, 2062, 2063
Philips	2021, 2062, 2096, 2124
Pilot	2014
Pioneer	2010, 2055, 2080, 2081, 2123
Portland	2016, 2017, 2019, 2110
Proscan	2000, 2001
Protec	2061
Pulsar	2104
Quarter	2011
Quartz	2011
Quasar	2021, 2022, 2125
RCA	2000, 2001, 2003, 2013, 2021, 2055, 2056
.....	2082, 2083, 2084, 2085, 2086, 2087, 2088, 2089, 2090
.....	2091, 2107, 2115, 2120, 2125
Radioshack/Realistic	2002, 2011, 2013, 2014, 2021
.....	2022, 2023, 2026, 2029, 2049, 2050, 2096, 2131
Radix	2014
Randex	2014
Ricoh	2128
Runco	2104
Samsung	2005, 2013, 2015, 2033, 2053, 2112
Sanky	2132, 2104
Sansui	2010, 2092, 2111, 2123
Sanyo	2011, 2013, 2023
Scott	2012, 2015, 2025, 2032, 2035, 2038, 2065, 2093,
.....	2116
Sears	2011, 2014, 2021, 2023, 2048, 2049, 2050
.....	2051, 2055, 2056, 2107, 2118
Sharp	2002, 2017, 2029, 2094, 2095, 2096, 2131
Shintom	2004, 2056, 2061, 2098
Shogun	2013
Signature	2002, 2131
Singer	2021, 2061, 2128
Sony	2002, 2004, 2098, 2099, 2119, 2128
STS	2021, 2107
Sylvania	2002, 2021, 2022, 2026, 2062, 2063, 2065, 2124
Symphonic	2002, 2026
Tandy	2002, 2011
Tashiko	2014
Tatung	2058, 2111
TEAC	2002, 2026, 2058, 2085, 2111
Technics	2021, 2109
Teknika	2002, 2014, 2021, 2026, 2100, 2129
Tmk	2013, 2024, 2047
Toshiba	2015, 2049, 2051, 2055, 2065, 2093, 2116
ToteVision	2013, 2014
Unitech	2013
Vector Research	2009, 2010, 2015, 2016
Victor	2010
Video Concepts	2009, 2010, 2015, 2016, 2113
Videosonic	2013
Wards	2002, 2013, 2014, 2015, 2021, 2023, 2026,
.....	2029, 2055, 2056, 2061, 2096, 2101, 2102, 2103, 2107,
.....	2116, 2131
XR-1000	2021, 2026, 2061
Yamaha	2009, 2010, 2011, 2018, 2058, 2111
Zenith	2004, 2098, 2104, 2119, 2128

Audio

(For RCA and Dimensia brands only)

AM/FM	4003
Aux	4004
Phono	4005
CD	4007
Tape	4006

Cable Boxes

ABC	5002, 5003, 5004, 5005, 5006, 5007, 5053
Antronix	5008, 5009
Archer	5008, 5009, 5010, 5011
Cabletenna	5008
Cableview	5008
Century	5011
Citizen	5011
Colour Voice	5012, 5013
Comtronics	5014, 5015
Contec	5016
Eastern	5017
Garrard	5011
GC Electronics	5009
Gemini	5018, 5019, 5049
General Instrument	5003
Hamlin	5020, 5021, 5022, 5035, 5045
Hitachi	5003
Hytex	5002
Jasco	5011
Jerrold	5003, 5005, 5007, 5018, 5023, 5024, 5046, 5053
Magnavox	5025
Memorex	5026
Movie Time	5002, 5027, 5028
NSC	5002, 5027, 5028
Oak	5002, 5016, 5029
Panasonic	5048, 5052
Paragon	5026
Philips	5011, 5012, 5013, 5019, 5025, 5030, 5031, 5032
Pioneer	5033, 5034
Pulsar	5026
RCA	5047, 5049, 5052
Realistic	5009, 5049
Regal	5022, 5035
Regency	5017
Rembrandt	5003
Runco	5026
Samsung	5014, 5034
Scientific Atlanta	5006, 5036, 5037, 5038
Signal	5014, 5018
Signature	5003
SL Marx	5014
Sprucer	5052
Starcom	5007, 5018, 5053
Stargate	5014, 5018
Starquest	5018
Tandy	5040
Televue	5014
Tocom	5004, 5023, 5041
Toshiba	5026
Tusa	5018
TV86	5027
Unika	5008, 5009, 5011
United Artists	5002
United Cable	5053
Universal	5008, 5009, 5010, 5011
Videoway	5044
Viewstar	5015, 5025, 5027, 5040
Zenith	5026, 5050, 5051

Satellite Receivers

Chapparral	5056, 5057
Drake	5058, 5059
GE	5000
General Instruments	5060, 5061, 5062
Panasonic	5075
Primestar	5076
Proscan	5000
RCA	5000
Realistic	5063
Sony	5072
STS1	5064
STS2	5065
STS3	5066
STS4	5067
Toshiba	5068, 5073
Uniden	5069

FEATURES AND MENUS

USING THE TV

This section explores the features and menus of your TV beginning with some information on using menus and control panels.

Each menu is then outlined and special features are detailed in order to help you get the most from your TV.

This section also includes information on using your GUIDE Plus+ system.

1 SETUP AND CONNECTIONS



2 INTERACTIVE SETUP



3 USING THE REMOTE



4 FEATURES AND MENUS



5 REFERENCE

FEATURES AND MENUS

MENUS AND CONTROL PANELS

Using the buttons on both the remote and front panel enable you to access and make changes to the Menus and Control Panels.

Menus use the point and select rule to navigate, but control panels use a variety of methods to adjust features on your TV. The following pages detail how to use these controls in order to customize the functions of your TV.

MENUS

The first menu is called the Main menu. Press MENU on the remote or on the front panel to bring up the Main menu.

Menus take you to another menu or a control panel. There are two ways to select a choice in a menu:

- Point with the arrow buttons and then select with MENU or OK.
- Press a number button on the remote. For example, in the Main menu press 3 to go straight to the Screen menu.

Exiting a menu

There are three ways to exit a menu:

- Point to *Exit* and press MENU or OK.
- Press 0 on the remote.
- Press CLEAR. The on-screen displays are cleared from the screen and you are returned to TV viewing.

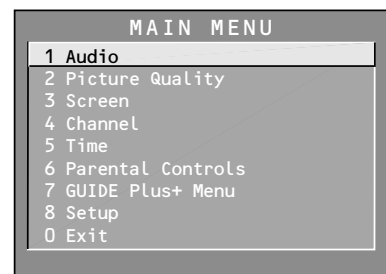

Feel free to explore the menu system. If you're ever unsure where you are in the menu system, or you're just plain tired of exploring, press CLEAR to remove the menus from the screen and start over again.

CONTROL PANELS

Control Panels allow you to adjust the default settings on many features of your TV. You can choose a setting, enter a number or adjust a level such as tint or brightness. There are three types of control panels: sliders, choice lists and numeric entry.

Sliders

Sliders are used to make adjustments to a particular control.

To use a Slider in a menu:

1. Press the up or down arrow to select the slider control for the feature you want to adjust.
2. Press the right or left arrow to adjust the indicator line on the slider.

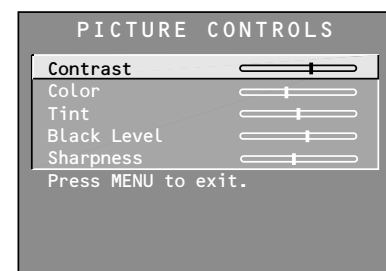

FEATURES AND MENUS

Numeric Entry

A numeric entry control panel is used to enter numbers or letters.

A pointer appears underneath the column you are changing.

1. Press the up arrow to enter a number in the column above the pointer.
2. Press the right arrow to move to the next column, then press the up or down arrow to enter a number.
3. When you have finished entering information, press MENU or OK.

CHOICE LISTS

Choice lists are used to choose a particular setting from a list of settings.

1. Point to a *choice on a menu* and press MENU or OK to select that choice.

Now that you know how to access the menus and adjust the control panels, the following pages provide a brief explanation of all the menu features. The features are organized in order of their location on the Main Menu.

AUDIO MENU

Mute Press OK to reduce the TV's volume to its minimum level. Press OK again to restore the volume.

Tone Controls Displays the slider controls for adjusting the TV's treble, bass and balance.

Audio Processor Displays a choice list of available audio modes, which control the way the sound comes through your speakers. You can also directly access this menu by pressing the SOUND button on your remote.

Mono Plays the sound in mono only. Use this setting when receiving broadcasts with weak stereo signals.

Stereo Most TV programs and recorded materials have stereo audio. The TV displays the word STEREO when you tune to a program that is broadcast in stereo.

Sound Logic™ Stereo Sound Logic technology monitors a program's audio track and limits volume excursions to a minimum and maximum volume range from the current volume setting. Acting like a dynamic range, it compresses to limit sudden volume increases, like when a commercial comes on.

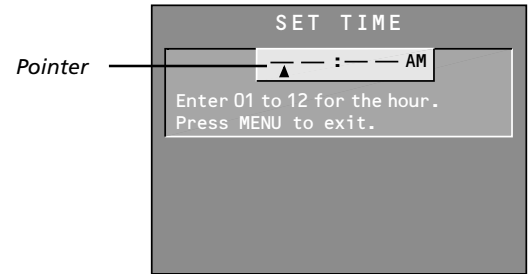

If the control panel is not set at the current time, use the left arrow to go back over the columns and the up arrow to make changes.

You can also enter numbers directly by using the number buttons.

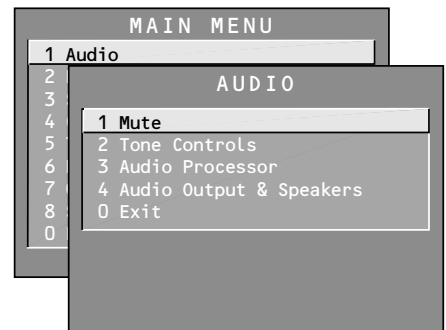

FEATURES AND MENUS

Second Audio Program (SAP) Plays the program's audio in a second language, if one is available. The TV displays the word SAP when you tune to a program that is broadcast with SAP information. SAP audio is broadcast in mono. SAP is also used to broadcast a program's audio with descriptions of the video for the visually impaired.

Audio Output & Speakers Displays a choice list that lets you turn the TV's internal speakers on or off and set the audio outputs to fixed-level or variable control level.

Variable Output, Speakers On This setting turns the TV's speakers on and allows variable output from the TV's audio output jacks.

Variable Output, Speakers Off This setting turns the TV's speakers off and allows variable output from the TV's audio output jacks.

Fixed Output, Speakers Off This setting turns the TV's speakers off and allows fixed output from the TV's audio output jacks to an external device such as a surround sound amplifier. With Fixed Output On, the TV's volume control, tone controls and mute are disabled.

USING THE REMOTE TO SELECT AN AUDIO PROCESSOR

You can change the audio processor from the Audio menu, as illustrated above, or by pressing the SOUND button on the remote. To make a selection using the remote:

1. Press SOUND to display the audio processor choice list.
2. Point to and select a different audio processor or press CLEAR to exit.

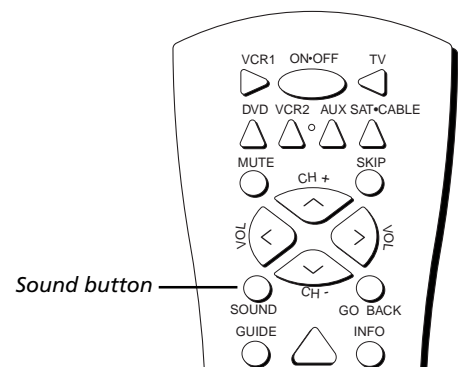

PICTURE QUALITY MENU

Basic Picture Controls Displays the five slider controls for adjusting the way the picture looks.

Contrast Adjusts the difference between the light and dark areas of the picture.

Color Adjusts the richness of the color.

Tint Adjusts the balance between the red and green levels.

Black Level Adjusts the brightness of the picture.

Sharpness Adjusts the crispness of edges in the picture.

When exiting this menu the *Save Personal Picture Preset Choice List* will appear. You can choose either Yes or No.

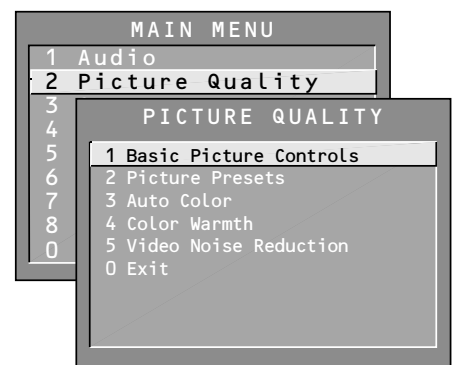

Picture Quality menu

Press the RESET button on the remote to bring up the Picture Control Presets choice list. Point to the desired setting; press MENU or OK to select it.

FEATURES AND MENUS

Picture Presets Displays a choice list that lets you select one of four preset picture settings: *Bright Lighting*, *Normal Lighting*, *Soft Lighting* or *Personal Picture Presets*. Choose the setting that is best for your viewing environment and edit your Personal Picture Preset.

Auto Color Displays a choice list that lets you turn on the feature that automatically corrects the color of the picture. (This is especially useful for tracking realistic flesh tone colors as you switch from channel to channel.) Choose *On* or *Off*, depending on your preference. It's your choice.

Color Warmth Displays a choice list that lets you set one of three automatic color adjustments: *Cool* for a more blue palette of picture colors; *Normal*; and *Warm* for a more red palette of picture colors. The warm setting corresponds to the NTSC standard of 6500°K.

Video Noise Reduction Displays a choice list that lets you turn on the feature that automatically reduces noise from the picture.

SCREEN MENU

Closed-Caption Display Displays a choice list that lets you choose the way closed captioning information is shown on the screen.

Off No captioning information displayed.

On Captioning information shown always, when available.

On When Sound is Muted Displays captioning information, when available, whenever the TV's sound is muted by pressing the MUTE button. The captioning information is not displayed when the sound is not muted.

Closed-Caption Mode Displays a choice list that lets you choose which captioning mode is used for displaying captioning information.

Menu Language Displays a choice list that lets you select your preferred language for the menus: *English*, *Spanish* or *French*.

Adjust Projection TV Lets you adjust the TV's three colors. Selecting *Green Centering* brings up a control panel that lets you center the green projection tube on the screen. Selecting *Red Convergence* or *Blue Convergence* lets you align the red and blue projection tubes.

USING CLOSED CAPTIONING

Many programs are encoded with closed captioning information, which lets you display the audio portion of a program as text on the TV screen.

Closed captioning is not available on all channels at all times. Only specific programs encoded with closed captioning information are applicable. When a program is closed captioned, the letters CC are displayed in the channel marker.

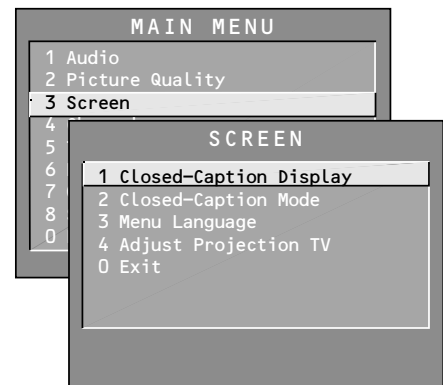

FEATURES AND MENUS

Closed Captioning Modes

The TV offers eight closed-captioned modes, including four text modes.

To Set the Closed-Captioning Mode:

1. Select *Screen* from the Main menu.
2. Point to *Closed-Caption Mode* and press OK. A choice list appears.
3. Point to your choice and press OK to select it and return to the Screen menu.

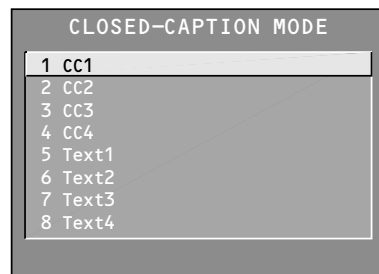

Turning off Closed Captioning

1. Select *Screen* from the Main menu.
2. Press OK to select *Closed-Caption Display*.
3. Point to *Off Always* and press OK. The closed captioning is turned off and you are returned to the Screen menu.

If you are unsure of the differences among the modes, you may prefer to leave the closed captioned mode set to CC1, which displays complete text of the program in the primary language in your area.

ADJUSTING THE COLOR PROJECTION TUBES

Your projection TV has three color projection tubes - one for red, one for green, and one for blue. When the tubes are precisely aligned they create the color images you see on the TV screen. Over time, the picture can drift out of alignment due to normal component aging, bumps and vibrations, or moving the TV. If you notice rings or halos around objects in the picture, you may want to readjust the alignment of the picture tubes.

To readjust the picture tubes, first do an overall adjustment with the *Adjust Projection TV* option in the *Screen* menu. The *Adjust Projection TV* option is used to center the green tube and align the blue and red tubes to the green tube. To make finer adjustments to specific areas of the screen, use the *Advanced Convergence* feature described on the next page.

To readjust the picture tubes:

1. Allow the set to warm up for at least 20 minutes.
2. Press the MENU button on the remote.
3. Press 3 to select the *Screen* option.
4. Press 4 to select the *Adjust Projection TV* option.
5. Press 1 to align *Green Centering*. Use the arrow buttons to center green square on screen. Press MENU when done.
6. Press 2 to align *Blue Convergence*. Use the arrow buttons to align blue crosshatch to green crosshatch. Press MENU when done.
7. Press 3 to align *Red Convergence*. Use arrow buttons to align red crosshatch to green crosshatch. Press MENU when done.
8. If you want to make finer color adjustments, press 4 to select *Advanced Convergence* (explained next) or press 0 to exit.

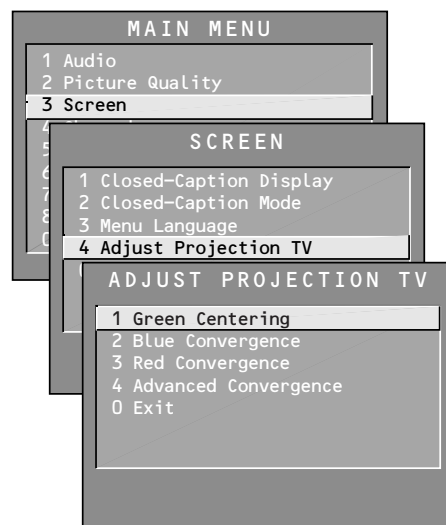

FEATURES AND MENUS

Advanced Convergence

After you have adjusted the color projection tubes as described previously, you can make finer adjustments to specific areas of the screen using the Advanced Convergence feature described below.

Note: Before you use the advanced convergence feature, you must complete the previous steps to align the tubes.

1. Press the MENU button on the remote.
2. Press 3 to select the *Screen* option.
3. Press 4 to select the *Adjust Projection TV* option.
4. Press 4 to select the *Advanced Convergence* option (the *Advanced Convergence* screen appears).

The green pattern is fixed. The red and blue patterns are adjusted to the green pattern. The *Red Convergence* appears first by default.

5. Colored cross-hairs show the current adjustment position on the grid. To move the cross-hairs to a different position, use the CH+/- buttons on the remote to move the cross-hair highlight up and down, and the VOL+/- buttons to move it right and left.
6. Use the arrow buttons to adjust the red pattern. Each press of the arrow button makes a slight adjustment from the center of the cross-hairs – you can press and hold the desired arrow button to make a faster adjustment, and then make fine adjustments with single presses of the arrow button.
7. Press the INFO button to switch to Blue Convergence and follow the steps above to adjust the blue pattern.
8. Press OK to exit. You will be asked if you want to save the adjustments.

Yes Saves adjustments

No Returns to the *Advanced Convergence* screen allowing further adjustments.

Clear Exits screen without making any changes.

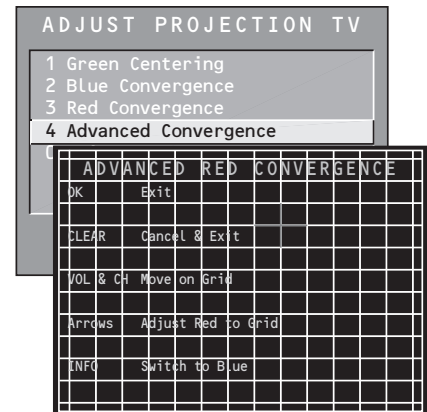

CHANNEL MENU

Signal Type Displays a choice list that lets you select the current antenna type. This option does not appear when the GUIDE Plus+ system is set up.

UHF/VHF Antenna Choose this if you are currently using an off-air antenna for TV signals.

Cable TV Choose this if you are currently using cable or a cable box for TV signals.

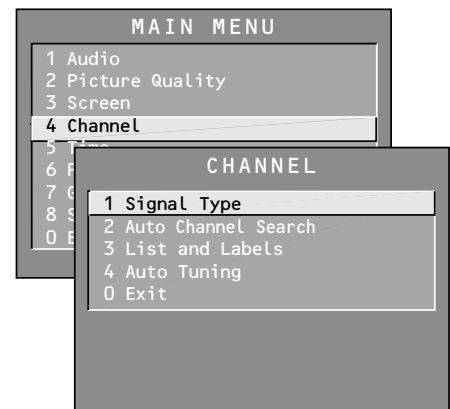

FEATURES AND MENUS

Auto Channel Search Tells the TV to search automatically for all the channels available through the antenna input. When the TV finds an active channel, it places it in the channel list; inactive channels (weak stations or channels with no signal at all) will be removed from the channel list. If you are using a cable box and have setup your GUIDE Plus+ system, this option will not appear.

List and Labels Displays a control panel that lets you custom-build your Normal channel list and choose a six-character label for each channel. Follow the on-screen directions to enter your channels and other information.

Channel # Use the up and down arrows to scroll up and down through the channel scan list. You can enter the channel number directly using the number buttons.

Normal List Only the channels included in the Normal list are available when you scan up and down using the CH +/- buttons. Use the up and down arrows to indicate whether the channel number indicated is included (Yes) or is not included (No) in the Normal channel list.

Channel Labels Use the up and down arrows to enter a six-character label for each channel. Hold the button down to scroll quickly through the characters. Press RESET to clear a label. **The TV can store up to 27 labels in memory.**

Auto Tuning Displays a choice list that lets you set up the TV to automatically tune to the correct input channel when you press a component button (VCR1, DVD, VCR2, AUX or SAT•CABLE) on the remote.

Set VCR 1 Channel Displays a choice list that lets you select the channel that the TV tunes to when you press the VCR1 button.

Set VCR2 Channel Displays a choice list that lets you select the channel that the TV tunes to when you press the VCR2 button.

Set DVD Channel Displays a choice list that lets you select the channel that the TV tunes to when you press the DVD button.

Set SAT/Cable Channel Displays a choice list that lets you select the channel that the TV tunes to when you press the SAT•CABLE button.

The choices for each screen are:

Not Connected Choose this if you do not have a component connected to an antenna or video input on the back of the TV, or if you don't want the TV to tune to a channel when the particular component button is pressed.

Channel 2 (SAT/Cable only) Choose this if your component is connected to the antenna jack on the back of the TV, and you want the TV to tune to channel 2 when you press the specified component button. Reminder: Make sure the component's Ch 2/3/4 switch is set to channel 2.

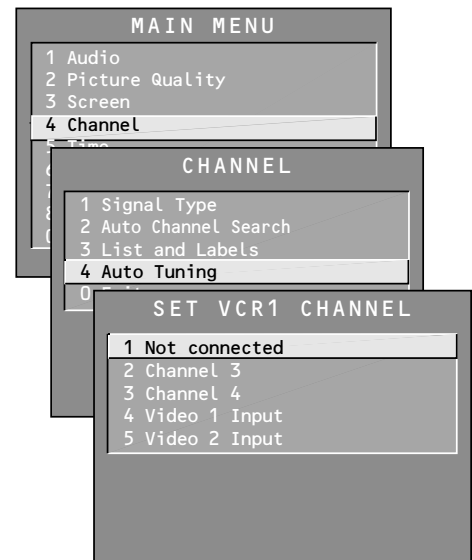

FEATURES AND MENUS

Channel 3 Choose this if your component is connected to the antenna jack on the back of the TV, and you want the TV to tune to channel 3 when you press the specified component button. Reminder: Make sure the component's Ch 3/4 switch is set to channel 3.

Channel 4 Choose this if your component is connected to the antenna jack on the back of the TV, and you want the TV to tune to channel 4 when you press the specified component button. Reminder: Make sure the component's Ch 3/4 switch is set to channel 4.

Video 1 Input Choose this if your component is connected to the INPUT1 jacks on the back of the TV and you want the TV to tune to VID1 (SVID1 if you used an S-Video cable) input channel when you press the specified component button.

Video 2 Input Choose this if your component is connected to the INPUT2 jacks on the back of the TV and you want the TV to tune to VID2 (COMP2 if you used the Y P_B P_R jacks) input channel when you press the specified component button.

TIME MENU

Sleep Timer Displays a control panel that lets you select the amount of time you want to give the TV before it shuts itself off.

Schedule Displays a control panel that lets you set up a schedule for turning the TV on and off automatically. **Make sure to turn the schedule on.** The on-screen directions guide you through the steps needed to set the schedule.

Set Time Displays a control panel that lets you enter the current time. The on-screen directions guide you through the steps needed to set the time. If your GUIDE Plus+ system is setup and running then it will automatically update your time and this option will not be available.

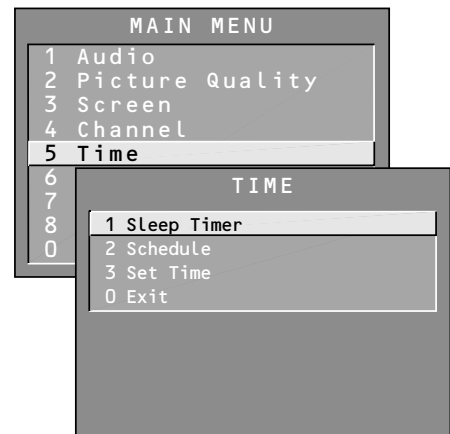

SETUP MENU

The setup routine is discussed earlier in the manual in the Interactive Setup section.

The first screen of the Interactive Setup appears automatically when you turn on your TV for the first time or after a power outage.

You can also access the Interactive Setup from the Main Menu.

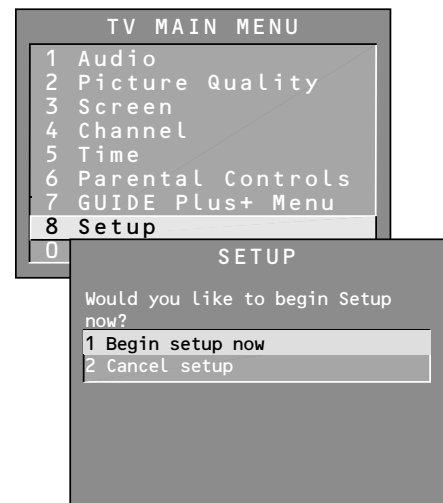

FEATURES AND MENUS

PARENTAL CONTROLS AND V-CHIP

The Parental Controls menu allows you to program your TV so that children cannot see certain programs, channels, or use the front panel controls. The first three choices in the Parental Controls menu involve software inside your TV (dubbed V-Chip) which allows you to “block” TV programs and movies based on violence, sex, or other content you may believe children should not view. In other words, it lets you program your TV so it will not display certain programs.

Once you block programs, you or other adults can “unblock” programs by entering a password.

The software inside your TV comes turned “off,” so if you choose not to implement it, you can just ignore it.

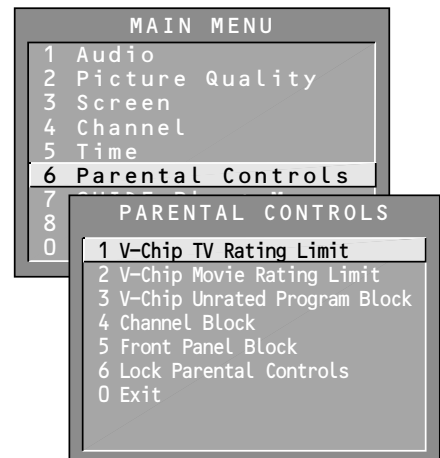

HOW V-CHIP WORKS

When turned “on,” the software reads a code that most broadcasters send with programs. That code tells the software the program’s age-based rating (TV-MA, TV-14, etc.) and content themes (Violence (V), Adult Language (L), etc.). If you have blocked the rating and/or content themes that the program contains, you will receive the message, “This channel is not approved for viewing,” when you turn to that particular channel.

Broadcasters are not required to provide content themes, so programs received with no content themes will only be blocked if you block their age-based rating. You can also block out programs that have been given a rating of “Not Rated,” and programs that are considered “unrated” because no code has been sent by the broadcaster. The TV age-based ratings and content themes you can block are listed in the following table.

FEATURES AND MENUS

Age-Based Rating	Description and Content Themes for Age-Based Ratings
TV-MA	Mature Audience Only. Specifically designed to be viewed by adults and may be unsuitable for children under 17. It contains one or more of the following content themes: crude indecent language (L), explicit sexual activity (S), or graphic violence (V).
TV-14	Parents Strongly Cautioned. Contains some material that many parents would find unsuitable for children under 14. Parents are strongly urged to exercise greater care in monitoring this program and are cautioned against letting children under the age of 14 watch unattended. This program contains one or more of the following content themes: intensely suggestive dialogue (D), strong coarse language (L), intense sexual situations (S), or intense violence (V).
TV-PG	Parental Guidance Suggested. Contains material that parents may find unsuitable for younger children. Many parents may want to watch it with their younger children. The program contains one or more of the following content themes: some suggestive dialogue (D), infrequent coarse language (L), some sexual situations (S), or moderate violence (V) .
TV-G	General Audience. Most parents would find this program suitable for all ages. It contains little or no sexual dialogue (D), no strong language (L) little or no sexual situations (S), or violence (V).
TV-Y7	Directed to Children 7 years and older. Designed for children ages 7 and above. It may be more appropriate for children who have acquired the developmental skills needed to distinguish between make-believe and reality. Themes and elements in this program may include mild fantasy violence (FV) or comedic violence, or may frighten children under the age of 7.
TV-Y	All Children. Themes and elements in this program are designed for a young audience, including children from ages 2-6. It is not expected to frighten younger children.

V-CHIP TV RATING LIMIT

The V-Chip TV Rating Limit lets you decide what TV programs can and cannot be viewed.

To set TV programming limits:

1. Choose *Parental Controls* from the Main menu. If Parental Controls have previously been locked, you must enter your password. If they are not locked, you will get a message reminding you that your limits will not be effective until you lock Parental Controls.
2. Press MENU to continue.
3. Highlight and select *V-Chip TV Rating Limit*.
4. Once you get to the V-Chip TV Rating Limit screen, use the arrows and OK on your remote to change the status of a TV program rating or content theme from *View* to *Block*.

The following sections give you more details about how to change the status of TV program limits.

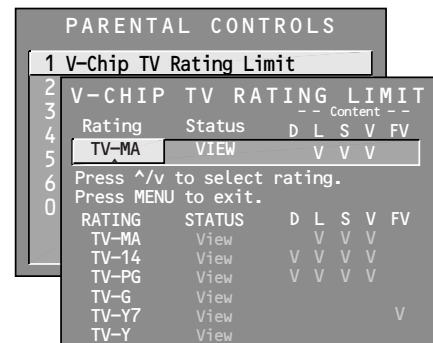

FEATURES AND MENUS

The Ratings Limits Screen

Below is an example of where items are located within the Rating Limits screen.

Rating Field

Lets you select from a list of age-based ratings you can block or view.

Rating Status Field

Lets you select whether the status of the age-based rating limit to the left is View or Block.

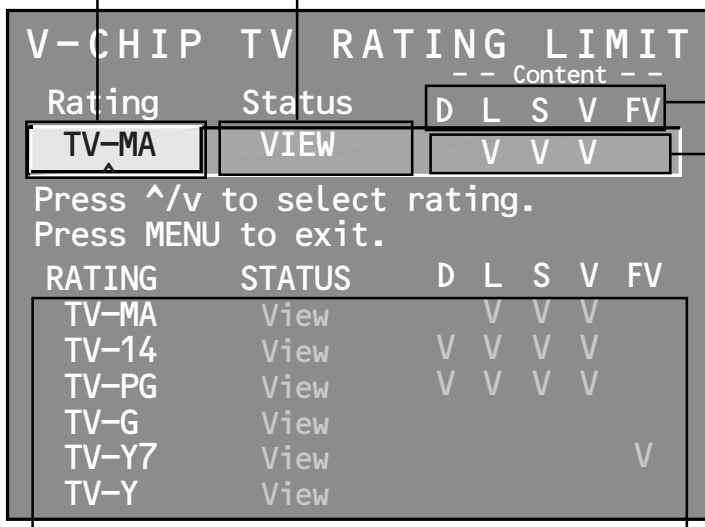

Content Themes

Lists the content themes you can block or view.

Content Status Fields

Lets you select which content themes to view for the selected rating, and whether the status of the content theme is currently View (V) or Block (B).

Rating Settings Area

Lets you see the current block/view state of age-based ratings and associated content. The View (V) settings are coded in green, and the Block (B) settings are coded in red.

Blocking Age-Based Ratings

You can automatically block all program ratings above a specified age-based rating level. For example, if you only want your child to watch programs that have a TV-G rating and lower (in other words, you want the child to watch TV-G, TV-Y7, and TV-Y), then you need to block out other programming with higher ratings.

To block programs with higher ratings:

1. First, determine the lowest level rating you do not want the child to watch.
2. Use the left and right arrows to highlight the Rating Field.
3. Use the up and down arrows on the remote to scroll through the age-based rating limits. Keep scrolling until the rating corresponding with the lowest rating you do not want the child to watch appears.

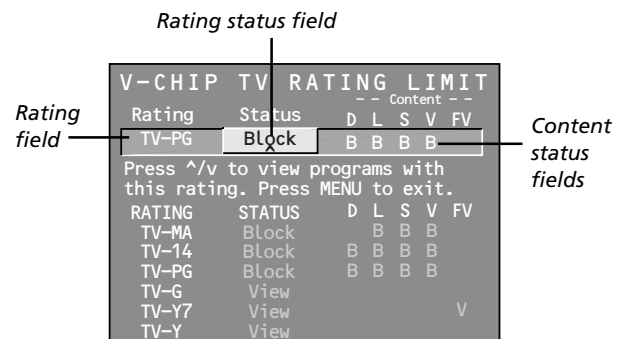

When you change the status of a rating to Block, the system will automatically block higher ratings and all corresponding content themes.

FEATURES AND MENUS

In the example discussed previously, you would scroll through the rating field until TV-PG appears, since the highest rating you want the child to watch is TV-G.

- Use the right arrow to move the yellow highlight to the rating status field.
- Press the up or down arrow to toggle from *View* to *Block*. The status for the rating listed to the left and all higher ratings automatically changes to *Block* (B).
- Press MENU or OK on the remote to return to the menu or exit the screen when you are finished.
- Select Lock Parental Controls from the Parental Controls menu. Enter a password, and if you have not already set your password, you will be prompted to enter it again to confirm.

Hierarchy of Age-Based Ratings

TV-MA	Mature Audience Only
TV-14	Parents Strongly Cautioned
TV-PG	Parental Guidance Suggested
TV-G	General Audience
TV-Y7	Directed to Children 7 years and older
TV-Y	All Children

Pressing RESET on the remote will reset all ratings to View and V.

Viewing Age-Based Ratings

After you block age-based ratings, you have the option of changing some of the ratings back to *View*.

- Determine which blocked rating you want to view.
- Use the left and right arrows to highlight the Rating Field.
- Use the up and down arrows to select the rating whose status is *Block*.
- Press the right arrow to move the yellow highlight to the rating status field.
- Press the up or down arrows to toggle between *View* and *Block*.

Note that the content status fields corresponding to the unblocked rating become *View* as well. They and the age-based rating status are the only fields that automatically change back to *View* when you complete this process.

Rating status field

V-CHIP TV		RATING LIMIT				
Rating	Status	-- Content --				
		D	L	S	V	FV
TV-14	View	V	V	V	V	
Press ^/v to block programs with this rating. Press MENU to exit.						
RATING	STATUS	D	L	S	V	FV
TV-MA	Block	B	B	B	B	
TV-14	View	V	V	V	V	
TV-PG	Block	B	B	B	B	
TV-G	View					
TV-Y7	View				V	
TV-Y	View					

Rating field

Content status fields

You must remember to Lock Parental Controls for rating limits to take effect.

Blocking Specific Content Themes

You can block programs based on their content. (Content is represented by the D, L, S, V, and FV on your screen. See the beginning of this section for details.) When you block a content theme for a particular rating, you automatically block that content theme for higher rated programs as well.

For example, if you do not want your child to watch programs that have adult language (L) rated TV-PG or higher, then you could block out all programming TV-PG and above containing adult language.

Content Themes

D	Sexually Explicit Dialogue
L	Adult Language
S	Sexual Situations
V	Violence
FV	Fantasy Violence

FEATURES AND MENUS

To block program content:

1. Determine the lowest level of content you do not want the child to watch.
2. Use the left and right arrows to highlight the Rating Field.
3. Use the up and down arrows on the remote to scroll through the age-based ratings until the rating that corresponds with the lowest content you do not want the child to watch appears. (In the example above, you would scroll through the ratings until the TV-PG rating appeared.)
4. Press the right arrow to move the highlight to the field corresponding with the content theme you wish to block.
5. Press the up or down arrow to change content status from V to B. All higher ratings' content theme will automatically change to B.

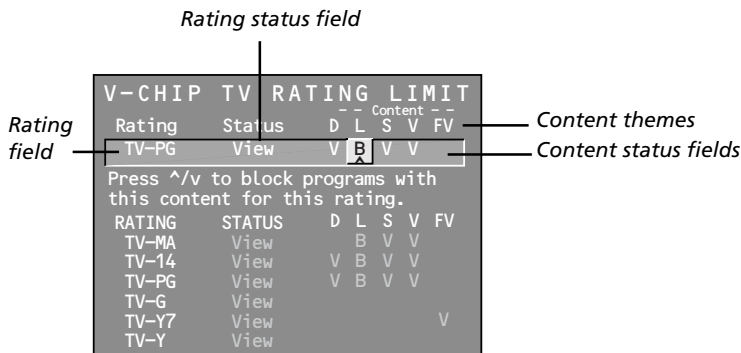

Broadcasters are not required to provide content themes or age-based ratings. Programs received with no content themes will only be blocked if you block their age-based rating.

You must remember to Lock Parental Controls for rating limits to take effect.

6. Press MENU or OK to return to the menu or exit the screen.

Viewing Specific Content Themes

If you block specific content themes, you have the option of going back and changing some of the content themes back to View (V):

1. Determine the content themes you want to change to View (V).
2. Use the left and right arrows to highlight the Rating Field.
3. Use the up and down arrows to scroll through the age-based ratings until the rating whose content theme you want to change to View appears.
4. Press the right arrow to move the yellow highlight to a particular content theme status, such as the B under language (L) corresponding with TV-14.
5. Press the up or down arrows to change its status back to V. Your child would then be able to watch programs with TV-14 adult language content, but not programs with TV-PG or TV-MA language content.

Note that only the content theme status corresponding to TV-14 language (L) changes to View (V). Higher rated content themes, such as that for TV-MA language, do not change.

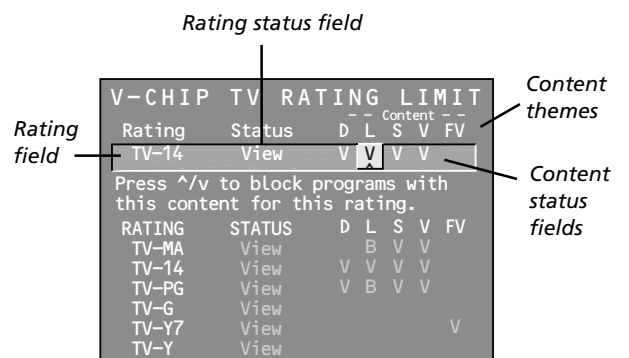

Pressing RESET on the remote will reset all ratings to View and V.

FEATURES AND MENUS

V-CHIP MOVIE RATING LIMIT

You set movie rating limits by blocking movies rated above a specified level.

Blocking Movie Ratings

If you only want your child to watch movies that have a PG rating and lower (in other words, movies rated PG and G), then you could automatically block out all other movies with higher ratings.

To block movies:

1. Highlight the rating field and press the up and down arrows to find the rating that is the lowest rating you do not want the child to watch. (In the example above, you would point to the rating status button corresponding to PG-13, since the highest rating you want the child to watch is PG.)
2. Use the right arrow to highlight the rating status field. Press the up and down arrows to change the button from *View* to *Block*. All higher ratings' *View* buttons will automatically change to *Block*.
3. Press OK to return to the menu or exit the screen.
4. If Parental Controls are not locked, you must lock them so the movie rating limits will take effect.

Viewing Movie Ratings

After you block movie ratings, you have the option of changing some of the rating status buttons back to *View*:

1. Highlight the rating field and press the up and down arrows to find the rating you want to view.
2. Use the right arrow to highlight the rating status field. Press the up and down arrows to change the button from *Block* to *View*.

For example, if movies with a rating of PG-13 and higher are blocked, you can change the rating status button corresponding with NC-17. Your child would then be able to watch all movies with a G, PG, and NC-17 rating.
3. Press MENU or OK to return to the menu or exit the screen, and be sure parental controls are locked.

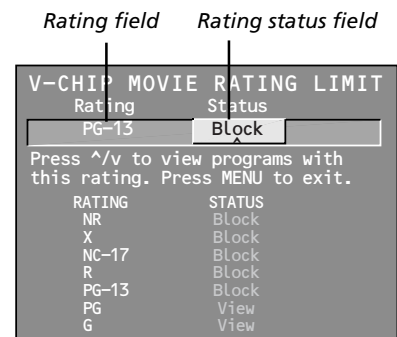
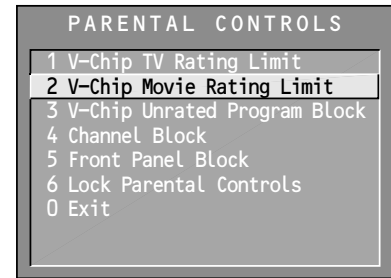

Some movies may be given a Not Rated (NR) rating. After blocking movie ratings, you must set NR to View separately to view NR movies.

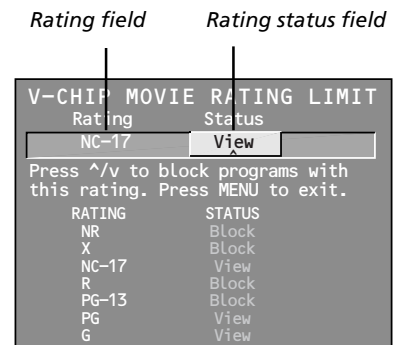

FEATURES AND MENUS

V-CHIP UNRATED PROGRAM BLOCK

Selecting this option lets you decide if programs that the V-Chip recognizes as "unrated" can be viewed. Note that "unrated" TV programs may include news, sports, political, religious, local and weather programs, emergency bulletins, public announcements, and programs without ratings.

View All unrated programs are available.

Block All unrated programs are not available.

Don't forget to lock parental controls after you change the status of unrated program viewing. If you do not, the limit will not take effect.

CHANNEL BLOCK

Selecting this option lets you decide what channels can be viewed.

View Makes the selected channel viewable.

Block The front panel and remote CH (channel) buttons will tune only to channels that you have marked as *View*. You may tune to a blocked channel manually by using the number buttons and entering the correct password.

Don't forget to lock parental controls after you change the status of Channel Block. If you do not, the channel block will not take effect.

FRONT PANEL BLOCK

Selecting this option lets you block (disable) or unblock (enable) the TV's front panel. The remote still tunes to any channel. Front Panel Block can:

- Keep children from watching TV when the parent is not present.
- Keep small children from playing with the buttons.

(When using this as a Parental Control method, you should remove access to any remote capable of controlling the front panel while you have the Front Panel blocked.)

Don't forget to lock parental controls after you change the status. If you do not, the front panel block will not take effect.

LOCK/UNLOCK PARENTAL CONTROLS

Selecting this option lets you lock and unlock parental controls settings using a password.

If you do not lock parental controls, none of the settings for V-Chip, Channel Block, or Front Panel Block will take effect.

If you forget your password, press and hold TV on the remote and the MENU button on the television simultaneously for 3 seconds. Parental controls will then unlock and you can re-enter a password via *Lock Parental Controls*.

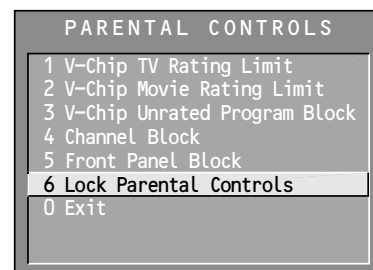
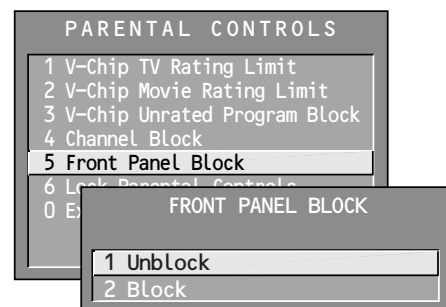
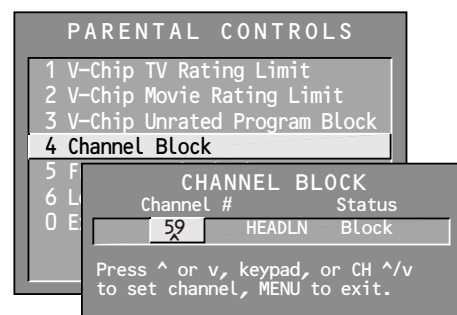
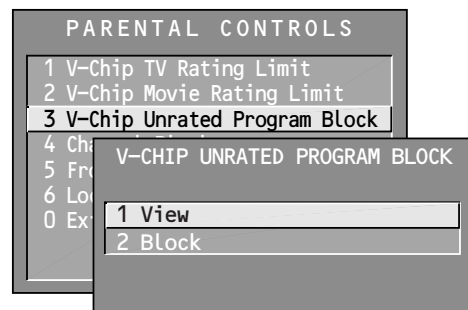

FEATURES AND MENUS

ABOUT THE GUIDE Plus+ SYSTEM

The GUIDE Plus+ system is an interactive on-screen program guide that lists TV schedules for your area and allows your TV direct control of a cable box and VCR. You must first set up the GUIDE Plus+ Menu system in order to view it (see the *Interactive Setup* section for more details). To bring up the GUIDE Plus+ system, press GUIDE.

There are six sections to a GUIDE Plus+ system:

- A row of Action buttons at the top of the screen numbered 1, 2 and 3
- Video window
- Program information
- A row of Menu options
- Channel listings
- Promotional information

Note: The GUIDE Plus+ system screens illustrated in this book are representations of what you are likely to see. Not all channels, programs, and GUIDE Plus+ information depicted will be available in your area. New features and options can be downloaded to the GUIDE Plus+ system, so these too are subject to change.

DOWNLOADING DATA

The GUIDE Plus+ system is not available until it completes its first download of program listings. When the power is turned off, the TV locates a "host channel" that carries GUIDE Plus+ system data containing program schedule and channel lineup information. A channel lineup is the list of stations and their respective channels.

To ensure that your first download of data is complete, you should leave your TV off overnight. Downloads occur several times a day. The TV must be turned off for GUIDE Plus+ system data to download.

If the TV loses power or is unplugged, GUIDE Plus+ system program listings may be lost. When power is restored, make sure the setup information is still correct. The GUIDE Plus+ system will receive updated program information during the next scheduled download.

Channel Lineup

If more than one cable company services your area, you may be prompted with *STEP 5: Choosing Your Channel Lineup* after the first GUIDE Plus+ system download. You will need to identify your cable company by selecting the correct channel numbers for the stations in question.

- Use the up and down arrow buttons to change the channel group and press OK when the correct channel group is highlighted.

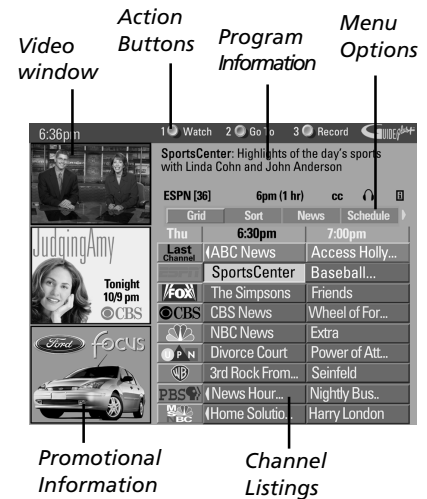

Since the program information provided by the GUIDE Plus+ system is based on your locale, you will need to run Setup again if you move.

FEATURES AND MENUS

Getting In & Out of the GUIDE Plus+ System

To enter the GUIDE Plus+ system:

- Press GUIDE on the remote.

There are three ways to exit the GUIDE Plus+ system:

- Highlight a program and press OK to exit the GUIDE Plus+ system and tune to the channel.
- Press GUIDE to exit the GUIDE Plus+ system and tune to the channel displayed in the video window.
- Press CLEAR to exit the GUIDE Plus+ system and return to the original channel.

The GUIDE Plus+ System Menus

The GUIDE Plus+ system offers seven different options on the Menu bar: *Grid, Sort, News, Schedule, Messages, Channels* and *Setup*. To access the Menu bar:

1. Press GUIDE to access the GUIDE Plus+ system.
2. Press MENU or use the up and down arrow buttons to select the Menu bar (the Grid Guide appears by default).
3. Use the left and right arrow buttons to access other menus.
4. Press OK, or MENU, or use the down arrow button to see the menu options.

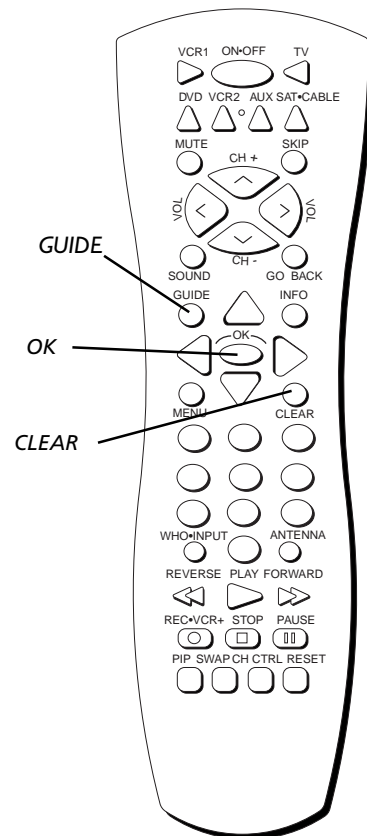

GRID GUIDE

The Grid Guide appears each time you enter the GUIDE Plus+ system. It displays the current programming for each channel. The current program is displayed in the video window.

- Press the up and down arrow buttons on the remote to browse channel listings and the channel up and down buttons to page through the listings. Use the right and left arrow buttons to browse future program listings.
- To tune to a channel, highlight the program you want to view in the channel listing and press OK. Press CLEAR to exit the GUIDE Plus+ system and return to the original channel. Press GUIDE to exit the GUIDE Plus+ system and tune to the channel in the video window.

Then use the Grid Guide Action Buttons as described next.



FEATURES AND MENUS

Grid Guide Action Buttons

Action buttons will change according to where you are in the GUIDE Plus+ system. Be sure to look at the action bar before pressing the command numbers.

When highlighting the program, the following Action buttons appear:



- **Watch** Press 1 on the remote to place a timer in the Schedule for the TV to turn on and tune to the program highlighted in the channel listing. When the TV turns on, the GUIDE Plus+ system will automatically appear with the scheduled program highlighted and tuned in the video window.
- **Go To** Press 2 on the remote to bring up the direct dial box and enter the number of the channel you want. Press OK to highlight the channel and current program in the channel listing of the Grid guide. Press OK again to tune to the highlighted channel. If the video window is unlocked, it will automatically tune to the channel.
- **Record** Press 3 on the remote to place a timer in the Schedule for the VCR to record the program highlighted in the channel listing.

If you have a cable box, changing channels on the TV will not cause the cable box channel to change while recording.

Record will only appear if you have set up the GUIDE Plus+ system and specified your VCR type.

The program information window will display a confirmation when you have successfully scheduled a program to watch or record.

Note: If you have selected two programs to watch or record which begin at the same time or overlap, you will receive a timer conflict message. You must choose between the two programs.

When highlighting the Channel names (the left column on the channel listing), the following Action buttons appear:



- **Lock/Unlock** Press 1 to lock or unlock the video window to either stay at one channel as you browse the GUIDE Plus+ system (lock) or change as you browse through different channels (unlock).
- **Go To** Press 2 on the remote to bring up the direct dial box and enter the number of the channel you want. Press OK to highlight the channel and current program in the channel listing of the Grid Guide. If the video window is locked, press OK to tune to the highlighted channel. If the video window is unlocked, it will automatically tune to that channel.

Grid Guide
Action Buttons

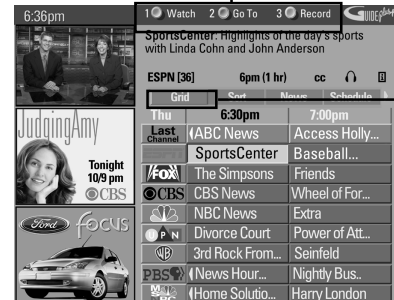

Grid Guide
Menu
Selection

The PIP button on the remote also toggles the video window between locked and unlocked states.

FEATURES AND MENUS

SORT

The *Sort* menu lets you browse programs by category. The channel to which you are currently tuned is displayed in the video window.

To Sort:

1. If the GUIDE Plus+ system isn't on your screen, press GUIDE on your remote control.
2. Press MENU on the remote to select the Menu bar.
3. Use the arrows to highlight *Sort*. When *Sort* is highlighted for the first time, the *Movies* category is displayed. Thereafter, the last category used becomes the default. A listing of subcategories is displayed below the category name. Use the left and right arrows to highlight other categories.
4. Use the up and down arrow buttons to highlight a subcategory. For example, highlight *All* and press OK (the GUIDE Plus+ system sorts the programs).
5. Press the up and down arrow buttons to review the list one program at a time. Press the channel up and down to review the list one page at a time.
6. Select MENU to return to the menu bar, or press GUIDE or CLEAR to exit the GUIDE Plus+ system.

Then use the Sort Menu Action Buttons as described next.

Sort Menu Action Buttons

When viewing the results of a Sort, the following Action buttons will appear on the bar:



- **Watch** Press 1 on the remote to place a timer in the Schedule, and then follow the on-line help for further options. Placing a timer in the Schedule will cause the TV to turn on and tune to the program highlighted in the channel listing at the predetermined time.
- **Record** Press 3 on the remote to set the VCR to record the program highlighted in the channel listing. If you have a cable box, changing TV channels will not cause the cable box channel to change while recording.

The program information window will display a confirmation when you have successfully scheduled a program to watch or record.

Notes: If you have selected two programs to watch or record which begin at the same time or overlap, you will receive a timer conflict message. You must choose between the two programs.

Be sure that during the GUIDE Plus+ system setup you specified that you have a VCR.

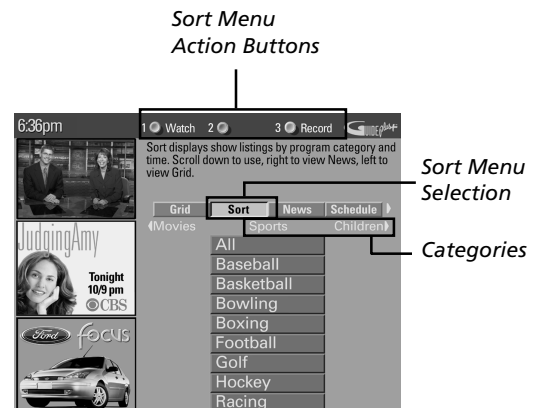

FEATURES AND MENUS

NEWS

The *News* menu lets you browse current news stories by headline.

1. If the GUIDE Plus+ system isn't on your screen, press **GUIDE** on your remote control.
2. Press **MENU** on the remote control to select the menu bar.
3. Use the arrows to highlight *News* (if MSNBC is available on your TV, it will appear in the video window).
4. Use the up and down arrows to highlight a story.
 - Use the up and down arrows to browse the list one story at a time.
 - Use the channel up and down to browse through the list one page at a time.
5. Press the right arrow button to see full text.
6. If there are multiple pages of text, press the right or left arrow button to page forward or back through the pages of text. Press the down arrow to view the next story.
7. Select **MENU** to return to the Menu bar, or press **GUIDE** or **CLEAR** on the remote to exit the GUIDE Plus+ system.



News Menu Selection

SCHEDULE

The *Schedule* menu lets you create timers for either viewing or recording programs. The GUIDE Plus+ system allows one-button recording if you have positioned the G-LINK cable wand in front of your VCR. See the *Setup and Connections* section of this manual for more details on positioning the G-LINK cable.

To schedule a program to watch or record:

1. If the GUIDE Plus+ system isn't on your screen, press **GUIDE** on your remote control.
2. Press **MENU** on the remote to select the Menu bar.
3. Highlight a program within the channel listing.
4. Select *Watch* or *Record* from the Action buttons bar. The timer is then automatically logged into the *Schedule* menu.
5. If you select *Record*, make sure to place a blank tape in the VCR and turn it off.

Note: If you have a cable box connected to your TV and VCR, tune your VCR to the cable box output channel prior to turning off the VCR.

The program information window will display a confirmation when you have successfully scheduled a program to watch or record.

Note: If you have selected two programs to watch or record which begin at the same time or overlap, you will receive a timer conflict message. You must choose between the two programs.

Schedule Menu Action Buttons

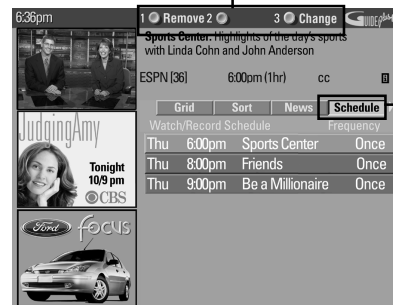

Schedule Menu Selection

FEATURES AND MENUS

To remove or change the frequency (daily, once, or weekly) of a scheduled event, access the *Schedule* menu from the Menu bar.

1. Press GUIDE to bring up the GUIDE Plus+ system.
2. Press MENU on the remote to select the Menu bar.
3. Use the arrows to highlight the *Schedule* menu selection.
4. Use the up and down arrows to highlight the program you want to edit.

Then use the Schedule Menu Action Buttons as described next.

Schedule Menu Action Buttons

When viewing the Schedule menu the following Action buttons will appear on the bar:



- **Remove** Highlight the Watch or Record timer you wish to remove from the schedule and press 1 on the remote.
- **Change** Highlight the Watch or Record timer you wish to change and press 3 on the remote to toggle the frequency between the following choices:

DAILY records the same program each day Monday through Friday.

ONCE records only on that day.

WEEKLY records the program each week at the same time.

MESSAGES

Occasionally you will receive messages regarding your GUIDE Plus+ system, as well as special programming information. You can access these messages from the Messages Menu on the Menu bar.

To read messages:

1. Press MENU on the remote to select the Menu bar.
2. Use the arrows to highlight the Messages menu selection.
3. Highlight the message you wish to read by using the up and down arrows.
4. Press INFO to display the full text of the message. If the text continues beyond the screen, press INFO to view the next page of text. Once you have reached the end of the message, pressing INFO closes the expanded information and returns you to the Messages screen.
5. Then use the Messages Menu Action Button as described in the next section.

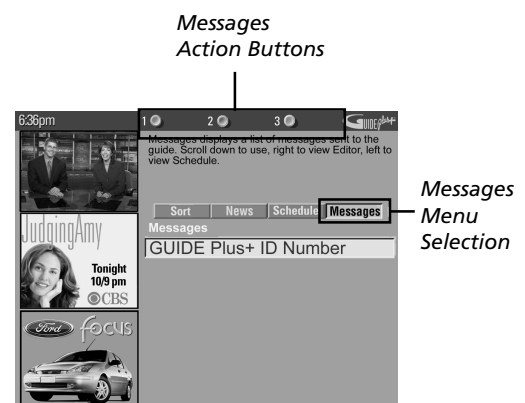

FEATURES AND MENUS

Messages Menu Action Button

When viewing the Messages menu the following Action button will appear on the bar:



- **Remove** Highlight the message you wish to delete and press 1 on the remote.

CHANNELS

You may customize the channel listing by enabling or disabling the display of certain channels. For instance, you may disable channels that you never watch. You can restore disabled channels at a later point in time.

1. Press GUIDE to bring up the GUIDE Plus+ system.
2. Press MENU to highlight the Menu bar.
3. Use the right and left arrows to highlight the *Channels* menu selection.
4. Use the up and down arrows to select a channel.

Then use the Channels Menu Action Buttons as described in the next section.

Channels Menu Action Buttons

While browsing the Channels menu, the following Action buttons are available on the bar:



- **Cancel** Press 1 on the remote to cancel any changes made since entering the Channels Menu.
- **Change** Press 2 on the remote to change the channel number for the highlighted channel line.
- **On/Off** Press 3 on the remote to toggle the state of the channel between On and Off.

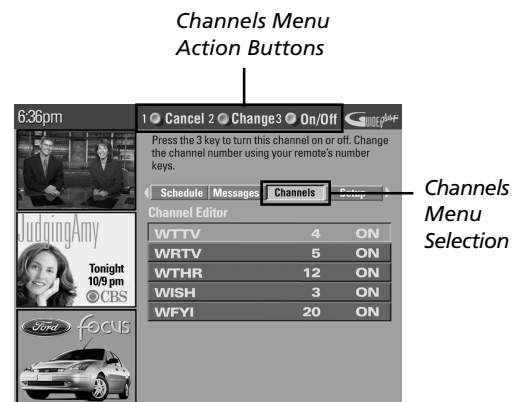

FEATURES AND MENUS

SETUP

The *Setup* menu allows you to access the GUIDE Plus+ system setup information. To access the Setup option:

1. If the Guide Plus+ system isn't on your screen, press GUIDE on your remote control.
2. Press MENU to select the Menu Bar.
3. Use the right arrow to highlight the *Setup* menu selection.
4. Use the up and down arrows to select *Change system settings*, *Review options*, or *View demo*.
 - **Change system settings** Confirms the settings you completed in the GUIDE Plus+ system setup are correct.
 - **Review options** Displays the GUIDE Plus+ auto display options.
 - On** Automatically displays the GUIDE Plus+ system when you press the ON•OFF button on the remote control.
 - Off** Disables the GUIDE Plus+ system from being displayed when you press the ON•OFF button on the remote control.
 - **View demo** Runs the GUIDE Plus+ system demonstration.

Note: If you have not completed your GUIDE Plus+ system setup, these options will not be available. A screen will prompt you to complete your setup.

HOW TO GET MORE INFORMATION ABOUT AN ADVERTISEMENT OR A PROGRAM

To find out more information about a program, advertisement or special, use the left arrow button to highlight the channel listing or promotional information box.

Requesting more information about a particular show displays the PlusCode programming number and the *Shows on Next* for that channel.

Press the INFO button to exit the expanded information screen.

PIP (PICTURE-IN-PICTURE) OPERATION

The PIP (picture-in-picture) feature lets you display a second, smaller picture on top of the main picture. **If the PIP window is displayed, and you change the PIP input (by pressing WHO•INPUT) to COMP2, PIP is not displayed. If you press the PIP button while viewing COMP2, the PIP window is not available. (N/A) appears in the channel marker.**



Promotional Information

FEATURES AND MENUS

PIP Buttons

There are seven remote buttons that control the way the PIP window works:

PIP Brings up the PIP window. Press PIP again to remove the window.

Arrow buttons let you move the PIP window to different areas of the screen.

SWAP Switches, or "swaps," the video from the PIP window with the main picture.

CH CTRL (Channel Control) Lets you switch channel control between the PIP window and the main picture.

For instance, press PIP to bring up the PIP window. You can change channels by entering channel numbers or pressing the CH[^] (channel up) or CH^v (channel down) buttons. When you press the CH CTRL button the channel control switches to the main picture. You can now change channels in the main picture by entering channel numbers or pressing the CH[^] or CH^v buttons.

Press CH CTRL again to return the channel control to the PIP window.

Two Tips for Using PIP Buttons

Skip to PIP: Channel Surfing in the Main Picture

You can surf through the channels during commercial breaks using the SKIP and CH (channel) buttons.

1. Press SKIP to set the commercial skip timer and bring up the PIP window.
2. Press the CH[^] or CH^v buttons to surf through the channels in the main picture. When the SKIP feature times out, the main picture will tune to the original channel automatically.

Channel Surfing in the PIP Window

You can use the PIP window to surf through channels as well.

1. Press PIP to bring up the PIP window.
2. Press the CH[^] or CH^v buttons. The TV begins displaying each channel in the PIP window. If you see a channel that interests you, press SWAP.

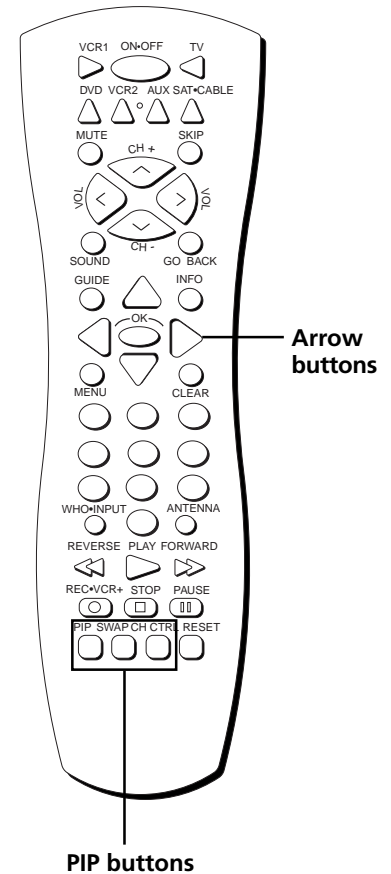

A typical use of SWAP is to scan through channels in the PIP window, and when you find a channel you like, press SWAP to display that channel in the main picture, sending the current channel to the PIP window.

FEATURES AND MENUS

CHANNEL MARKER

There are several indicators that come up when you press the TV, INFO, PIP or SWAP button. This display is called the Channel Marker.

12:01 Displays the current time.

CC Displayed when Closed Captioning is available on the current channel.

VCR1 Displays the label assigned to the current channel.

VID1 Displays the current channel or input channel (VID1 or SVID1, VID2 or COMP2).

Mute (or Stereo) Mute is displayed when you mute the audio. Stereo is displayed when the current channel is broadcasting in Stereo.

SAP Displayed when the current channel is broadcasting SAP (Second Audio Program) information.

PIP 59 (PIP Chan) Displays the current PIP channel.

Sleep Displayed when the Sleep Timer has been set.

00:00 Displayed to count down time left on the commercial skip (SKIP) timer.

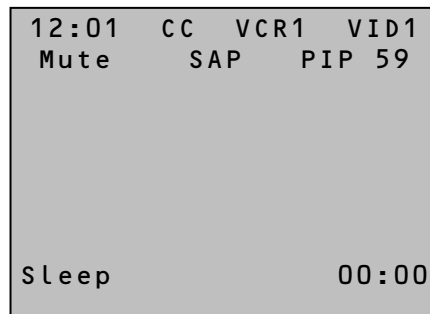

Sample displays on a Channel Marker

GUIDE Plus+ MENU ITEMS

The *GUIDE Plus+ Menu* gives you access to features in the GUIDE Plus+ system. To access the *GUIDE Plus+ Menu*:

1. Press MENU on the remote.
2. Highlight *GUIDE Plus+ Menu* and press OK.

Each menu and the sub-menus are listed below:

GUIDE Plus+ Setup Displays *STEP 4: Confirming Your Settings* screen of the GUIDE Plus+ system setup.

Yes, everything is correct Confirms the settings you completed in the GUIDE Plus+ system setup are correct.

Yes, but my channel lineup is incorrect Displays *STEP 5: Choosing Your Channel Lineup* screen, allowing you to change your lineup if it is incorrect.

No, repeat setup process Begins the GUIDE Plus+ system setup.

GUIDE Plus+ Label Displays the GUIDE Plus+ label menu.

On Displays the station name when you change channels.

Off The station name isn't displayed when you change channels.

Continuous Demo Runs the GUIDE Plus+ system demonstration until it is turned off. **To turn off the demonstration, you must turn off the TV.**

Note: If you have not completed your GUIDE Plus+ system setup, these options will not be available. A screen will prompt you to complete your setup.

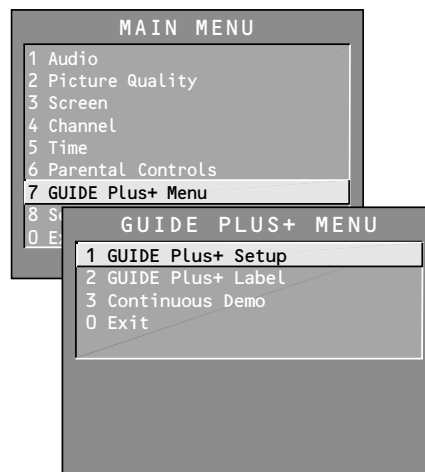

REFERENCE

TROUBLESHOOTING

Troubles sometimes are caused by simple “faults” that you can correct without the help of a service technician. If you experience any difficulty with your TV, check a few basic remedies before calling your service technician.

TV will not turn on

- Check to make sure it is plugged in.
- Check the wall receptacle (or extension cord) to make sure it is “live” by plugging in something else.
- Maybe batteries in remote control are “dead.”
- Maybe remote control is not aimed at remote sensor.
- The front panel controls may be locked (disabled). Use the remote control to unlock the front panel controls by selecting the *Front Panel Block* in the Parental Controls menu and choosing *Unblock*.

Controls don't work

- If using remote control, make sure remote is in TV mode by first pressing TV button.
- The front panel MENU button may be disabled. Use the remote control to turn off blocking. Select *Front Panel Block* in the Parental Controls menu and choose *Unblock*.
- Try unplugging set for two minutes and then plug it back in and turn it on again.

Problems with remote

- Maybe something is between the remote and the remote sensor.
- Maybe the remote is not aimed directly at the component (TV or VCR) you are trying to control.
- Maybe remote is not in TV Mode. Press the TV button so remote will control TV.
- Maybe batteries in remote are weak, dead or installed incorrectly. Try replacing batteries. (Note, if you remove the batteries, you may have to reprogram the remote to control other components.)
- Remove batteries and hold number 1 for at least 60 seconds to drain the microprocessor inside the remote. Release number 1, replace the batteries, and (if necessary) reprogram the remote.

Guide comes on when I turn on TV

- The Guide automatically comes up when you use the TV button on the remote to turn on the TV. You can turn off this feature by pressing GUIDE on your remote control and then press MENU to select the Menu bar. Press the right arrow to select *Setup*. Choose *Review Options* and then select *OFF*.

Turns off while playing

- Schedule off function may have been activated.
- Electronic protection circuit may have been activated because of a power surge. Wait 30 seconds and then turn on again. If this happens frequently, the voltage in your house may be abnormally high or low.
- Unplug. Wait five minutes. Plug in again.

TV turns on unexpectedly

- Scheduled On or Watch from the Guide may have been activated.

Blank screen

- Maybe the component connected to the input jacks is not turned on.
- Try another channel.
- Press RESET, in case the picture controls are set too low.

PIP not available

- If the PIP window is displayed, and you change the PIP input (by pressing WHO•INPUT) to COMP2, PIP is not displayed.
- If you press the PIP button while viewing COMP2, the PIP window is not available and cannot be seen.

REFERENCE

No sound, picture okay

- Maybe sound is muted. Try pressing volume up button to restore sound.
- Maybe speakers are turned off. Check the Audio Output and Speakers control panel in the Audio menu.
- If using an S-VHS component, remember to also connect the component's L and R AUDIO OUT jacks to the TV's L and R INPUT jacks.

Can't select certain channel

- Channel may be blocked or not approved in the Parental Controls menu.
- If using a VCR, check to make sure the TV/VCR switch on the VCR is in the correct position.

Noisy stereo reception

- May be a weak station. Use SOUND button to change to mono mode instead of stereo.

No picture, no sound but TV is on

- Maybe the cable/air function is set to the wrong position.
- Maybe a vacant channel is tuned.
- If watching VCR (connected only through antenna input), make sure TV is tuned to channel 3 or 4 – same as CH3/4 switch on VCR. Also check to make sure TV/VCR switch on VCR is in the correct position.

Sound okay, picture poor

- Check antenna connections.
- Try adjusting sharpness function to improve weak signals.

Black box appears on the screen

- Captioning may be turned on. Check the Closed-Caption Display control panel in the Channel menu.

G-LINK Cable not working

- Check to make sure the wands are positioned correctly.
- GUIDE Plus+ system control of cable box is slower than direct control of the box itself. Keep this in mind when changing channels.

Incorrect GUIDE Plus+ System channel map

- The guide may get out of sync with the cable provider. Use setup to change the zip code to 99999. Turn the TV off for ten minutes. Use setup again to change the zip code to the correct value. Be sure to select the correct lineup if asked.

REFERENCE

CARE AND CLEANING

CAUTION: Turn OFF your TV before cleaning.

You can clean the TV as required, using a soft lint-free cloth. Be sure to occasionally dust the ventilation slots in the cabinet to help assure adequate ventilation.

The TV's screen may be cleaned with a soft, lint-free cloth as well. Take care not to scratch or mar the screen. If necessary, you may use a cloth dampened with warm water. Never use strong cleaning agents, such as ammonia-based cleaners, or abrasive powder. These types of cleaners will damage the TV.

While cleaning do not spray liquid directly on the screen, or allow liquid to run down the screen and inside the TV. Also, avoid placing drinks or vases with water on top of the TV. This could increase the risk of fire or shock hazard or damage to the TV.

Caution: Using video games or any external accessory with fixed images for extended periods of time can cause them to be permanently imprinted on the picture tube (or projection TV picture tubes). ALSO, some network/program logos, phone numbers, etc. may cause similar damage. This damage is not covered by your warranty.

LIMITED WARRANTY

What your warranty covers:

Defects in materials or workmanship.

For how long after your purchase:

- One year from date of purchase for labor charges.
- One year from date of purchase for parts.
- Two years from date of purchase for picture tubes.

The warranty period for rental units begins with the first rental or 45 days from date of shipment to the rental firm, whichever comes first.

What we will do:

- Pay any Authorized RCA Television Service Center the labor charges to repair your television.
- Pay any Authorized RCA Television Service Center for the new or, at our option, refurbished replacement parts and picture tubes required to repair your television.

How you get service:

- Request home or pick-up, repair, and return service from any Authorized RCA Television Service Center, provided that your television is located within the geographic territory covered by an Authorized RCA Television Service Center. If not, you must take your television to the Service Center location at your own expense, or pay for the cost the Service Center may charge to transport your television to and from your home. To identify your nearest Authorized RCA Television Service Center, ask your dealer, look in the Yellow Pages, or call 1-800-336-1900.
- Proof of purchase in the form of a bill of sale or receipted invoice which is evidence that the product is within the warranty period must be presented to obtain warranty service. For rental firms, proof of first rental is also required.

What your warranty does not cover:

- Customer instruction. (Your Owner's Manual describes how to install, adjust, and operate your television. Any additional information should be obtained from your dealer.)
- Installation and related adjustments.
- Signal reception problems not caused by your television.
- Damage from misuse or neglect.
- Batteries.
- Images burnt onto the screen.
- A television that has been modified or incorporated into other products or is used for institutional or other commercial purposes.
- A television purchased or serviced outside the U.S.A.
- Acts of nature, such as but not limited to lightning damage.

Product Registration:

- Please complete and mail the Product Registration Card packed with your television. It will make it easier to contact you should it ever be necessary. The return of the card is not required for warranty coverage.

REFERENCE

Limitation of Warranty:

- **THE WARRANTY STATED ABOVE IS THE ONLY WARRANTY APPLICABLE TO THIS PRODUCT. ALL OTHER WARRANTIES, EXPRESS OR IMPLIED (INCLUDING ALL IMPLIED WARRANTIES OF MERCHANTABILITY OR FITNESS FOR A PARTICULAR PURPOSE) ARE HEREBY DISCLAIMED. NO VERBAL OR WRITTEN INFORMATION GIVEN BY THOMSON MULTIMEDIA INC., ITS AGENTS OR EMPLOYEES SHALL CREATE A WARRANTY OR IN ANY WAY INCREASE THE SCOPE OF THIS WARRANTY.**
- **REPAIR OR REPLACEMENT AS PROVIDED UNDER THIS WARRANTY IS THE EXCLUSIVE REMEDY OF THE CONSUMER. THOMSON MULTIMEDIA INC. SHALL NOT BE LIABLE FOR INCIDENTAL OR CONSEQUENTIAL DAMAGES RESULTING FROM THE USE OF THIS PRODUCT OR ARISING OUT OF ANY BREACH OF ANY EXPRESS OR IMPLIED WARRANTY ON THIS PRODUCT. THIS DISCLAIMER OF WARRANTIES AND LIMITED WARRANTY ARE GOVERNED BY THE LAWS OF THE STATE OF INDIANA. EXCEPT TO THE EXTENT PROHIBITED BY APPLICABLE LAW, ANY IMPLIED WARRANTY OF MERCHANTABILITY OR FITNESS FOR A PARTICULAR PURPOSE ON THIS PRODUCT IS LIMITED TO THE APPLICABLE WARRANTY PERIOD SET FORTH ABOVE.**

How State Law relates to warranty:

- Some states do not allow the exclusion nor limitation of incidental or consequential damages, or limitations on how long an implied warranty lasts, so the above limitations or exclusions may not apply to you.
- This warranty gives you specific legal rights, and you also may have other rights that vary from state to state.

If you purchased your television unit outside the United States:

- This warranty does not apply. Contact your dealer for warranty information.

Service calls which do not involve defective materials or workmanship are not covered by this warranty. Costs of such service calls are the sole responsibility of the purchaser.

REFERENCE

Accessory Information

Antenna (or cable-TV) connections are made with either coaxial antenna cable or twin-lead cable. Coaxial cables are shielded so they are less susceptible to hum or interference from adjacent cables.

Most audio/video connections between components can

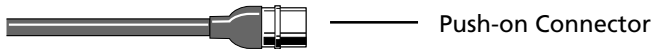

Push-on Connector

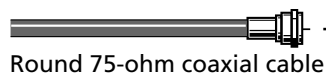

Round 75-ohm coaxial cable

Screw-on Coaxial Connector



Flat 300-ohm twin-lead cable

be made with shielded audio and video cables that have RCA-type phono connectors.



Standard Audio/Video cable with RCA-type phono plugs (such as No. VH83)

Color-Coded Jacks

The jacks on the TV's monitor panel are color-coded for ease of use. The video jacks are yellow, the right audio jacks are red, and the left audio jacks are white. When connecting components to each other, be sure that you always connect left outputs to left inputs and right outputs to right inputs. If a component has only one output (mono), connect it to the r/mono input jack.

To connect S-VHS (Super-VHS) components, an S-VHS video cable is required.



S-Video cable (such as No. VH913)

Gold-Plated Jacks and Gold-Tipped Cables

Gold plating helps prevent oxidation of contacts which provides much less loss than conventional contacts. A complete line of gold-tipped cables is available to help you obtain optimum performance from your equipment.

The following accessories are available from most dealers and electronics supply stores in case you want to position your components farther apart or need additional cables.

Antenna Cables

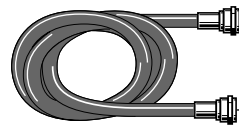

VH81 (3-ft)

VH82 (6-ft)

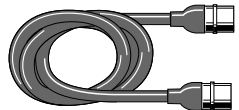

VH89 (6-ft)

Screw-on Cable attaches to the round antenna connectors (called 75-ohm F-type) on the back of your VCR or TV. The ends screw onto the connectors for a secure connection.

Push-on Cable attaches to the round antenna connectors (called 75-ohm F-type) on the back of your VCR or TV. Ends push on for a quick connection.

Audio/Video Cables

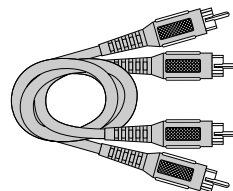

Gold-Tipped cable
VH83 (6-ft)

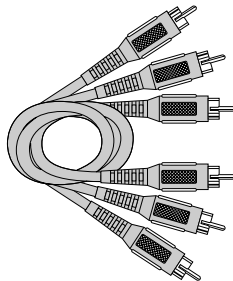

Gold-Tipped cable
AH84 (6-ft)

Monaural VCR Dubbing Cable
Double cable that lets you connect the video and audio jacks of two VHS VCRs to duplicate tapes. Can also be used to connect a VCR to your TV. Cable is color-coded and shielded. Has RCA-type phono plugs on each end.

Stereo VCR Dubbing Cable
Triple cable that lets you connect the VIDEO and AUDIO jacks of stereo components.

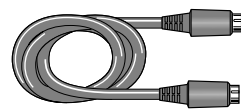

VH976 (6-ft)

VH913 (12-ft)

S-Video Cable has multi-pin connectors on each end for connecting S-Video components to your TV.

REFERENCE

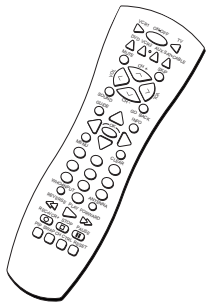

CRK76TA1

Remote Control This is the remote control that came packed with your TV. Replacements or spares can be ordered as needed.

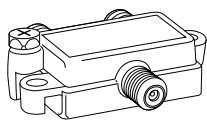

Splitter
VH47

2-way Signal Splitter helps you connect to a second TV or VCR.



ANT200

Amplified VHF/UHF/FM Antenna allows you to easily switch from the antenna signal to cable or satellite without disconnecting antenna.

Accessory Order Form

Description	Part No.	Price	Qty	Total
Screw-on antenna cable (3-ft)	VH81	\$3.95		
Screw-on antenna cable (6-ft)	VH82	\$4.95		
Push-on antenna cable (6-ft)	VH89	\$5.95		
Monaural VCR Dubbing Cable (6-ft)	VH83	\$5.95		
Stereo VCR Dubbing Cable (6-ft)	VH84	\$9.95		
S-Video Cable (6-ft)	VH976	\$7.95		
S-Video Cable (12-ft)	VH913	\$14.95		
2-way Signal Splitter	VH47	\$3.95		
Amplified Antenna	ANT200	\$49.95		
Antenna Mixer	193984	\$11.15		
Remote Control (CRK76TA1)	240895	\$29.20		
Audio•Video Adapter	228449	\$4.45		

Total Merchandise.....	\$
Sales Tax.....	\$
We are required by law to collect the appropriate sales tax for each individual state, country, and locality to which the merchandise is being sent.	
Shipping and Handling.....	\$ 5.00
Total Amount Enclosed.....	\$
Use VISA, MasterCard, or Discover Card preferably.	
Money order or check must be in U.S. currency only.	
No COD or CASH.	



Detach Here

Prices are subject to change without notice.

All accessories are subject to availability.

Please complete other side also

REFERENCE

Charge your order on your VISA, MasterCard, or Discover Card by filling in below

USE YOUR CREDIT CARD

IMPORTANT: Copy complete account number from your VISA card



My card expires:

IMPORTANT: Copy complete account number from your MasterCard



Copy Number above your name on MasterCard

My card expires:

IMPORTANT: Copy complete account number from your Discover Card



My card expires:

AUTHORIZED SIGNATURE
(Credit card order will not be processed without signature)

Print or type your name and address clearly.

A complete and correct order will save you days of waiting.



Name: _____
Street: _____
_____ Apt: _____
City: _____
State: _____ Zip: _____
Daytime Phone: _____

Please make sure that both sides of this form have been filled out completely.

- Allow 4 weeks for delivery.
- All accessories are subject to availability.
- Prices are subject to change.

Placing an Order

To place your order by phone, have your Visa, MasterCard or Discover Card ready and call the toll-free number listed below.

Use this number only to place on order for accessory items listed on this order form.

1-800-338-0376

To place your order by mail, detach and mail the completed order form with credit card information, money order or check in US currency (made payable to Thomson multimedia, Inc.) to the following address:

Video Accessories
PO Box 8419
Ronks, PA 17573

REFERENCE

A

Accessories 58

Advanced

Connections 6

Convergence 33

Age-Based Ratings 37

Audio Menu 29

Audio Output Volume & Speakers 30

Audio Processor 29

Audio remote codes 26

Audio/Video cables 7

Auto Channel Search 13, 34

Auto Color 31

Auto Tuning 16, 34

DVD Channel 18, 34

SAT/Cable Channel 19, 34

VCR1 Channel 16, 34

VCR2 Channel 17, 34

B

Back of the TV 6

Basic Connection 5

Basic Picture Controls 30

Batteries 10

Black Level 30

Buttons, remote 22

C

Cable Box remote codes 26

Channel

labeling 20

Lineup 43

menu 33

number 34

Channel 3 35

Channel 4 35

Channel Block 42

Channel Labels 34

Channel Marker 52

Closed Caption

Display 31

Mode 31

Coaxial cable 4, 5, 7

Color 30

Projection Tubes 32

Warmth 31

Connections

Advanced 6

Basic 5

TV and stereo VCR 7

TV Only 4

TV, VCR and Satellite receiver 8

TV, VCR, Satellite Receiver and DVD 8

Content Themes 37

Contrast 30

Control Panels 28

D

DVD Channel 18, 34

F

Finding the sensor 9

Fixed Output, Speakers Off 30

Front Panel

buttons 25

Front Panel Block 42

G

G-LINK 9

Grid Guide menu 44

GUIDE Plus+ System 14, 43

Channel Lineup 43

Setup 14

I

INPUT1 35

INPUT2 35

J

Jacks on the TV 6

L

Labels 20, 34

Language 13, 31

List & Labels Feature 20

M

Menu

Audio 29

Channel 33

Grid Guide 44

News 47

Picture 30

Screen 31

Setup 35

Sort 46

Time 35

Menu Language 13, 31

Menus 28

Mono 29

Mute 29

N

News menu 47

Normal List 34

P

Parental Controls

Channel Block 42

Front Panel Block 42

Lock/Unlock 42

Picture Presets 31

Picture Quality menu 31

PIP (Picture-in-Picture) 50

buttons 51

Point and Select 12

Programming the remote 23

Projection TV, convergence 31

R

Rating Limits

Movie 41

TV 37

Remote Control

buttons 22

Installing the batteries 10

Programming 23

sensor 9

Remote control sensor 9

S

S-Video cable 7

SAP (Second Audio Program) 30

SAT/Cable Channel 19, 34

Satellite Receiver remote codes 26

Schedule 35

Screen Menu 31

Set

DVD Channel 18, 34

SAT/Cable Channel 19, 34

VCR1 Channel 16, 34

VCR2 Channel 17, 34

Set Time 35

Setup Menu 35

Setup Screen 12

Sharpness 30

Signal Type

Cable TV 33

UHF/VHF Antenna 33

Sleep Timer 35

Sort menu 46

Sound Logic Stereo 29

Stereo 29

T

Time menu 35

Time of Day, setting 16

Tint 30

Tone Controls 29

Troubleshooting 53

TV Only connection 4

U

UHF/VHF Antenna 33

V

V-Chip

Age-Based Ratings 36

Blocking Movies 41

Content themes 36

Variable Output, Speakers 30

VCR Channels 16, 34

VCR remote codes 26

Video Noise Reduction 31

W

Warranty 56

Y

Y PB PR 6

Visit the RCA web site at www.rca.com

Please do not send any products to the Indianapolis address listed in this manual or on the carton. This will only add delays in service for your product.

Thomson multimedia Inc.

10330 North Meridian Street
Indianapolis, IN 46290

©2001 Thomson multimedia Inc.

Trademark(s)® Registered

Marca(s) Registrada(s)

Printed in USA

TOCOM 1572153A



Free Manuals Download Website

<http://myh66.com>

<http://usermanuals.us>

<http://www.somanuals.com>

<http://www.4manuals.cc>

<http://www.manual-lib.com>

<http://www.404manual.com>

<http://www.luxmanual.com>

<http://aubethermostatmanual.com>

Golf course search by state

<http://golfingnear.com>

Email search by domain

<http://emailbydomain.com>

Auto manuals search

<http://auto.somanuals.com>

TV manuals search

<http://tv.somanuals.com>