

RCA

ANT3038XR Outdoor Antenna User's Guide

Para obtener instrucciones en español,
consulte la página 9.

Assembling the ANT3038XR

BEFORE YOU START!!!

Please read the IMPORTANT SAFETY INFORMATION sheet included in this package.

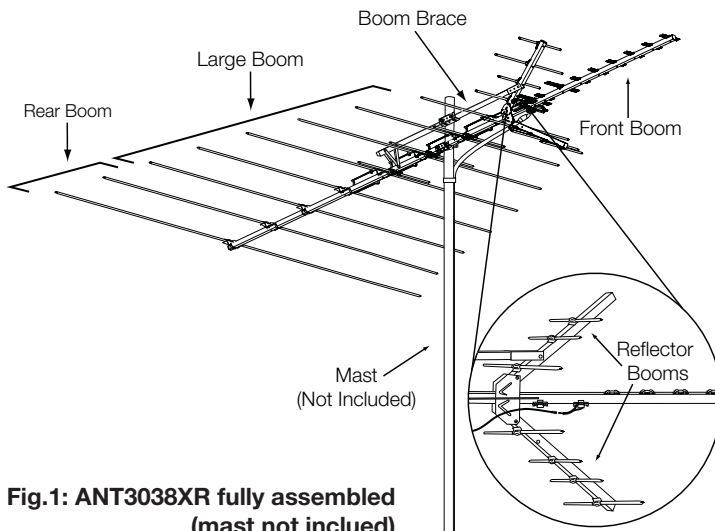
Step 1: Unpack

Remove all three sections of the antenna and the hardware bag from package. Make sure the following parts are in the package:

- (3) Antenna sections (rear, large/middle, and front booms)
- (1) Boom brace
- (2) Reflector booms
- (1) Hardware bag

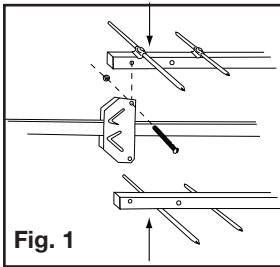
The hardware bag contains the following pieces:

- | | |
|------------------------|--------------------------|
| (2) U-Bolts | (4) 1/4" Flange nuts |
| (2) Mast clamp inserts | (5) End caps |
| (10) #10 Flange nuts | (4) #10 Screws |
| (8) #10 Washers | (1) Matching transformer |

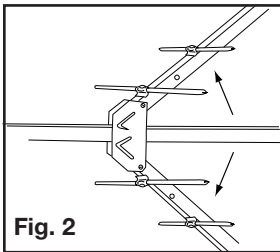


**Fig.1: ANT3038XR fully assembled
(mast not included)**

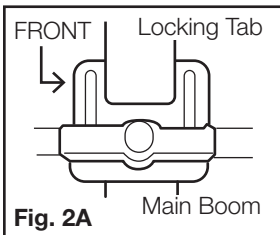
Step 2: Connect the reflector booms to the front (small) boom



Find the two reflector booms and the front (or small) boom. The two smaller elements on the reflector booms face away from the small main boom.



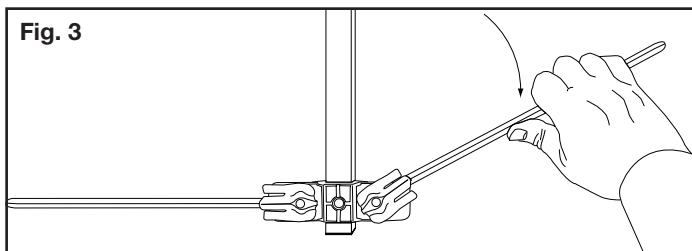
IMPORTANT: Unfold the elements on each end of the reflector boom so that the front of their locking tabs face towards each other. The remaining locking tabs can be unfolded in either direction. Make sure that all of the elements are perpendicular to the reflector boom.



Connect the two reflector booms to the front boom using two of the provided #10 nuts and screws. The reflector booms should be parallel to the smaller boom at this point. (See Fig. 1.)

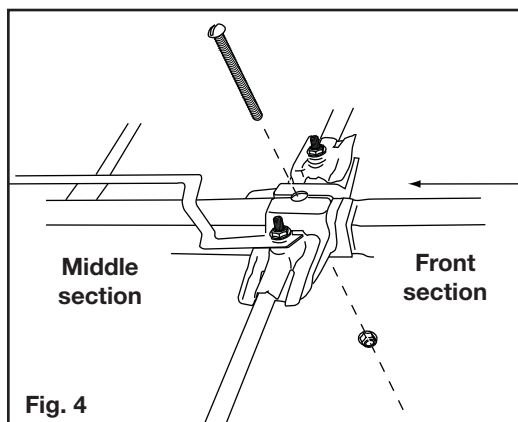
Step 3: Unfold the rest of the antenna

Unfold all the other elements on the antenna until they lock into place ensuring that they are flat and parallel to each other. (See Fig. 3.)



Step 4: Connect the middle (large) section to the front (small) section

Find the middle (large) section. Locate the end of the middle section that matches figure 4.



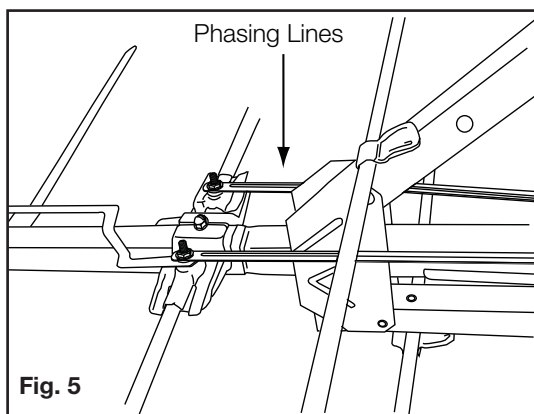
Remove the nut and screw in the center. Slide the narrow boom of the front (small) section into the middle (large) section. Make sure the phasing lines are on the top side of the small boom and the black plastic element holders are also on this same side. This is the top of the antenna. (See figure 5.)

Tap lightly with a rubber mallet on the end of the small boom aligning the holes for the screw. (See figure 4.)

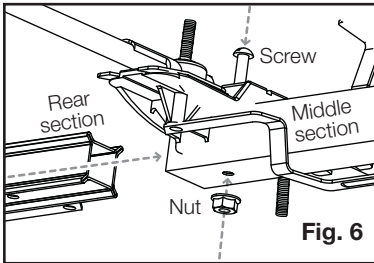
Re-install the screw and nut; be sure to tighten securely.

Step 5: Connect the phasing lines

Place the phasing lines from the front section over the studs. Secure them to the studs with #10 flange nuts and washers. Tighten securely.



Step 6: Connect the rear section to the middle (large) section

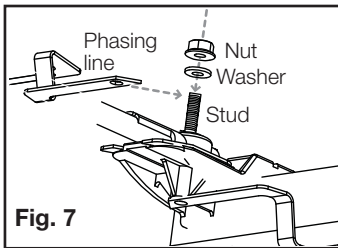


On the open end of the middle (large) section, remove the rear nut and screw.

Find the rear section. Slide the narrow boom of the rear antenna into the middle (large) section. Tap lightly with a rubber mallet on the end of the small boom, aligning the holes for the screw. (See figure 6.)

Re-install the screw and nut; be sure to tighten securely.

Step 7: Connect the phasing lines

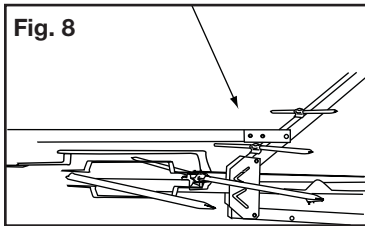


On the middle (large) section, near where the middle and rear sections come together, find the posts on the top and bottom of the last element holder studs. (See figure 7.)

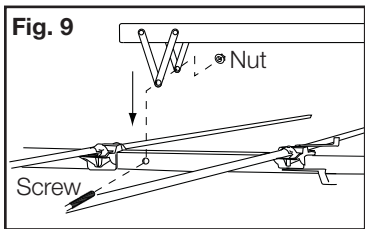
Place the phasing lines from the rear section over the studs, one on the top side and one on the bottom. Then fasten them to the posts with washers and #10 flange nuts. Tighten securely.

Step 8: Connect the boom brace

Lay the boom brace on top of the antenna. Make sure the mast clamps (the brass-colored sections) on the boom brace and antenna are facing the same direction.



Locate the screw hole in the reflector boom and attach the brace with one of the provided #10 screws and nuts. (See figure 8.)



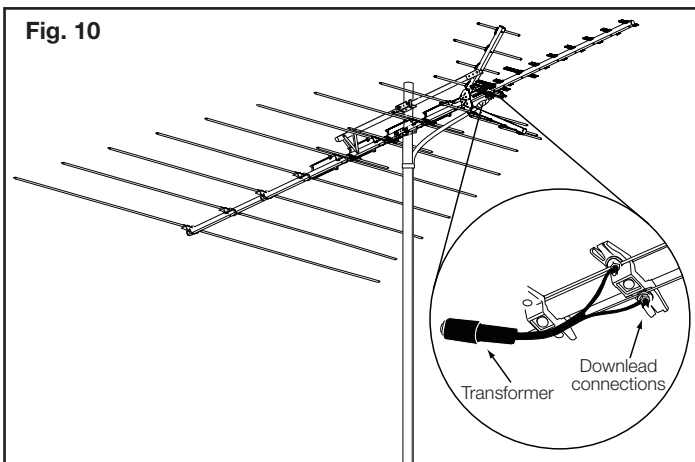
Swing the boom brace down towards the rear. Form a "V" with the metal straps. Use one of the provided #10 screws and nuts to attach the "V" to each side of boom. (See figure 9.)

Step 9: Install the transformer

Find the downlead connection on the bottom of the front section of the antenna, just beyond the reflector booms.

Place two washers on each of the studs. Place a #10 nut on top of each stud, but don't tighten them yet.

Place the transformer ends between the two washers and tighten the nuts securely. (See figure 10.) Attach the coax downlead to the transformer.



Step 10: Insert end caps

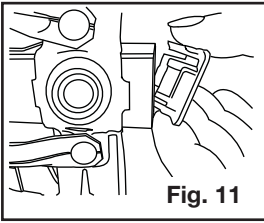


Fig. 11

Insert two of the plastic end caps in the ends of the antenna as shown in figure 11.

Insert a third plastic end cap in the exposed end of the boom brace.

Insert the last two end caps on the ends of the reflector booms.

Use a rubber mallet to gently tap them into the ends so that they are secure.

Step 11: Mount the antenna to a mast

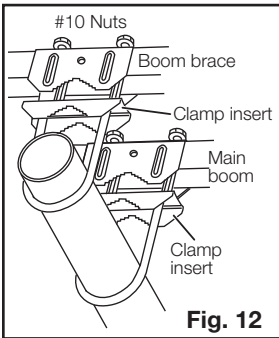


Fig. 12

Find the two U-bolts, four 1/4" flange nuts, and the two mast clamp inserts.

Place the mast clamp inserts on the inside of the mast clamps on the antennas as shown in figure 12. Then insert the U-bolts into the mast clamps and mast clamp inserts. Attach the nuts loosely.

Slide the antenna over the mast and lightly tighten the two mast clamps. (See figures 12 and 13.) The top side of the antenna is the side with the black plastic pieces on it.

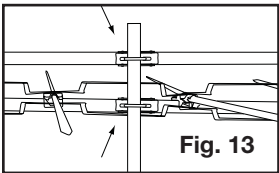
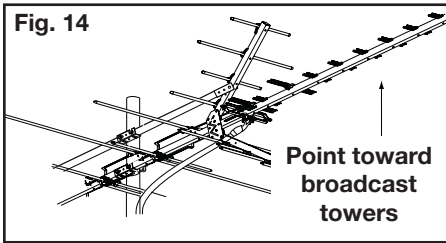


Fig. 13

Step 12: Connect the coax download to your TV or preamplifier



Connect the coax download to your TV.

Rotate the antenna until you receive the best picture. You will probably need a helper to view the TV set while you are rotating the antenna.

NOTE: Point the small end of the antenna towards the station(s).

Important: Point The Antenna Toward Your Local Broadcast Towers

Visit www.antennaweb.org to see the locations of your local broadcast towers. This information is crucial in pointing your antenna correctly.

Step 13: Secure mast clamps and download, ground the antenna

Tighten the two mast clamps securely.

Secure the coaxial download to the mast (using cable ties or electrical tape) to prevent it from whipping by the wind.

Ground the antenna and mast per the accompanying grounding instructions.

Antenna Removal

Removal of the antenna should be exactly the reverse of the installation instructions. Please, for your own safety, follow the instructions for installing the antenna starting with the last step first.

12 Month Limited Warranty

Audiovox Electronics Corporation (the "Company") warrants to the original retail purchaser of this product that should this product or any part thereof, under normal use and conditions, be proven defective in material or workmanship within 12 months from the date of original purchase, such defect(s) will be repaired or replaced (at the Company's option) without charge for parts and repair labor. To obtain repair or replacement within the terms of this Warranty, the product along with any accessories included in the original packaging is to be delivered with proof of warranty coverage (e.g. dated bill of sale), specification of defect(s), transportation prepaid, to the Company at the address shown below. Do not return this product to the Retailer.

This Warranty is not transferable and does not cover product purchased, serviced or used outside the United States or Canada. The warranty does not extend to the elimination of externally generated static or noise. This Warranty does not apply to costs incurred for installation, removal or reinstallation of the product, or, if in the Company's opinion, the product has been damaged through acts of nature, alteration, improper installation, mishandling, misuse, neglect, or accident. This warranty does not cover damage caused by an AC adapter not provided with the product. THE EXTENT OF THE COMPANY'S LIABILITY UNDER THIS WARRANTY IS LIMITED TO THE REPAIR OR REPLACEMENT PROVIDED ABOVE AND, IN NO EVENT, SHALL THE COMPANY'S LIABILITY EXCEED THE PURCHASE PRICE PAID BY PURCHASER FOR THE PRODUCT. This Warranty is in lieu of all other express warranties or liabilities. ANY IMPLIED WARRANTIES, INCLUDING ANY IMPLIED WARRANTY OF MERCHANTABILITY OR FITNESS FOR A PARTICULAR PURPOSE, SHALL BE LIMITED TO DURATION OF THIS WARRANTY. ANY ACTION FOR BREACH OF ANY WARRANTY HEREUNDER, INCLUDING ANY IMPLIED WARRANTY, MUST BE BROUGHT WITHIN A PERIOD OF 24 MONTHS FROM THE DATE OF ORIGINAL PURCHASE. IN NO CASE SHALL THE COMPANY BE LIABLE FOR ANY CONSEQUENTIAL OR INCIDENTAL DAMAGES WHATSOEVER. No person or representative is authorized to assume for the Company any liability other than expressed herein in connection with the sale of this product.

Some states/provinces do not allow limitations on how long an implied warranty lasts or the exclusion or limitation of incidental or consequential damage so the above limitations or exclusions may not apply to you. This Warranty gives you specific legal rights and you may also have other rights which vary from state/province to state/province.

U.S.A.: Audiovox Electronics Corporation, 150 Marcus Blvd.,
Hauppauge, NY 11788

CANADA: Audiovox Return Center, c/o Genco, 6685 Kennedy Road,
Unit #3 Door 16, Mississauga Ontario L5T 3A5

Free Manuals Download Website

<http://myh66.com>

<http://usermanuals.us>

<http://www.somanuals.com>

<http://www.4manuals.cc>

<http://www.manual-lib.com>

<http://www.404manual.com>

<http://www.luxmanual.com>

<http://aubethermostatmanual.com>

Golf course search by state

<http://golfingnear.com>

Email search by domain

<http://emailbydomain.com>

Auto manuals search

<http://auto.somanuals.com>

TV manuals search

<http://tv.somanuals.com>