

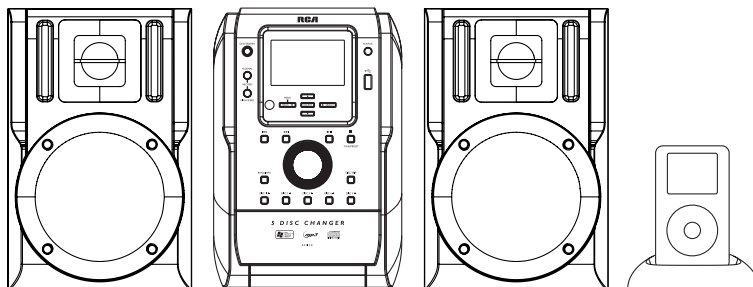

user **manual**
manual de usuario

RS2130i



iPod not included.
iPod no incluido.

It is important to read this instruction book prior to using your new product for the first time.
Es importante leer este manual antes de usar por vez primera su equipo.

FCC Information

EN

FCC Information

This device complies with Part 15 of the FCC Rules. Operation is subject to the following two conditions: (1) This device may not cause harmful interference, and (2) this device must accept any interference received, including interference that may cause undesired operation.

In accordance with FCC requirements, changes or modifications not expressly approved by Thomson Inc. could void the user's authority to operate this product.

This device generates and uses radio frequency (RF) energy, and if not installed and used properly, this equipment may cause interference to radio and television reception.

If this equipment does cause interference to radio or television reception (which you can determine by unplugging the unit), try to correct the interference by one or more of the following measures:

- Re-orient the receiving antenna (that is, the antenna for the radio or television that is "receiving" the interference).
- Move the unit away from the equipment that is receiving interference.
- Plug the unit into a different wall outlet so that the unit and the equipment receiving interference are on different branch circuits.

If these measures do not eliminate the interference, please consult your dealer or an experienced radio/television technician for additional suggestions. Also, the Federal Communications Commission has prepared a helpful booklet, "How To Identify and Resolve Radio TV Interference Problems." This booklet is available from the U.S. Government Printing Office, Washington, DC 20402. Please specify stock number 004-000-00345-4 when ordering copies.

This product complies with DHHS Rules 21 CFR Subchapter J. Applicable at the date of manufacture.



This audio system has earned the ENERGY STAR.

For Your Safety

The AC power plug is polarized (one blade is wider than the other) and only fits into AC power outlets one way. If the plug won't go into the outlet completely, turn

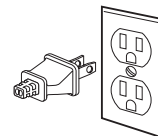

the plug over and try to insert it the other way. If it still won't fit, contact a qualified electrician to change the outlet, or use a different one. Do not attempt to bypass this safety feature.

CAUTION: To prevent electric shock, match wide blade of plug to wide slot, fully insert.

Main plug is used as the disconnect device, it shall remain readily operable and should not be obstructed during intended used.

To be completely disconnected the apparatus from supply mains, the main plug of the apparatus shall be disconnected from the mains socket outlet completely.

For Your Records

In the event that service should be required, you may need both the model number and the serial number. In the space below, record the date and place of purchase, and the serial number:

Model No.
Remote Control No.
Date of Purchase
Place of Purchase
Serial No.

	<p>CAUTION RISK OF ELECTRIC SHOCK DO NOT OPEN</p>	
<p>THE LIGHTNING FLASH AND ARROW-HEAD WITHIN THE TRIANGLE IS A WARNING SIGN ALERTING YOU OF "DANGEROUS VOLTAGE" INSIDE THE PRODUCT.</p>	<p>CAUTION: TO REDUCE THE RISK OF ELECTRIC SHOCK, DO NOT REMOVE COVER (OR BACK). NO USER-SERVICEABLE PARTS INSIDE. REFER SERVICING TO QUALIFIED SERVICE PERSONNEL.</p>	<p>THE EXCLAMATION POINT WITHIN THE TRIANGLE IS A WARNING SIGN ALERTING YOU OF IMPORTANT INSTRUCTIONS ACCOMPANYING THE PRODUCT.</p>
<p>SEE MARKING ON BOTTOM / BACK OF PRODUCT</p>		

WARNING: TO PREVENT FIRE OR ELECTRICAL SHOCK HAZARD, DO NOT EXPOSE THIS PRODUCT TO RAIN OR MOISTURE.

Important Safety Instructions

Please read and save for future reference

Some of the following information may not apply to your particular product; however, as with any electronic product, precautions should be observed during handling and use.

- Read these instructions.
- Keep these instructions.
- Heed all warnings.
- Follow all instructions.
- Do not use this apparatus near water.
- Clean only with dry cloth.
- Do not block any ventilation openings. Install in accordance with the manufacturer's instructions.
- Do not install near any heat sources such as radiators, heat registers, stoves, or other apparatus (including amplifiers) that produce heat.
- Do not defeat the safety purpose of the polarized or grounding-type plug. A polarized plug has two blades with one wider than the other. A grounding type plug has two blades and a third grounding prong. The wide blade or the third prong is provided for your safety. If the provided plug does not fit into your outlet, consult an electrician for replacement of the obsolete outlet.
- Protect the power cord from being walked on or pinched particularly at plugs, convenience receptacles, and the point where they exit from the apparatus.
- Only use attachments/accessories specified by the manufacturer.
- Use only with the cart, stand, tripod, bracket, or table specified by the manufacturer, or sold with the apparatus. When a cart is used, use caution when moving the cart/apparatus combination to avoid injury from tip-over.



Portable Cart Warning

- Unplug this apparatus during lightning storms or when unused for long periods of time.
- Refer all servicing to qualified service personnel. Servicing is required when the apparatus has been damaged in any way, such as power-supply cord or plug is damaged, liquid has been spilled or objects have fallen into the apparatus, the apparatus has been exposed to rain or moisture, does not operate normally, or has been dropped.

EN

Additional safety information

- Apparatus shall not be exposed to dripping or splashing and no objects filled with liquids, such as vases, shall be placed on the apparatus.
- Always leave sufficient space around the product for ventilation. Do not place product in or on a bed, rug, in a bookcase or cabinet that may prevent air flow through vent openings.
- Do not place lighted candles, cigarettes, cigars, etc. on the product.
- Connect power cord only to AC power source as marked on the product.
- Care should be taken so that objects do not fall into the product.
- Do not attempt to disassemble the cabinet. This product does not contain customer serviceable components.

If your product operates on batteries,

adhere to the following precautions:

- Any battery may leak electrolyte if mixed with a different battery type, if inserted incorrectly, or if all batteries are not replaced at the same time.
- Any battery may leak electrolyte or explode if disposed of in fire or an attempt is made to charge a battery not intended to be recharged.
- Discard leaky batteries immediately. Leaking batteries can cause skin burns or other personal injury. When discarding batteries, be sure to dispose of them in the proper manner, according to your state/provincial and local regulations.

Important Information

EN

Technical Specification

Product: 5CD Audio System
Brand: RCA
Model: RS2130i

Electrical Consumption:

Power Supply: 120V~60Hz
Power consumption: 150 Watts

Importer
Comercializadora Thomson de México,
S.A. de C.V.
Álvaro Obregón No. 151. Piso 13.
Col. Roma. Delegación Cuauhtémoc
C.P. 06700. México, D.F.
Telefono: 52-55-11-020360
RFC: CTM-980723-KS5

Service Information

This product should be serviced only by those specially trained in appropriate servicing techniques. For instructions on how to obtain service, refer to the warranty included in this Guide.

Safety Precautions

- Never open the cabinet under any circumstances. Any repairs or internal adjustments should be made only by a trained technician.
- Never operate this product with the cabinet removed.
- Do not use your Unit immediately after transporting it from a cold place to a warm place, as condensation may cause the unit to malfunction.
- Keep your unit away from humid areas and abnormally hot places.
- Do not touch the player with wet hands. If any liquid enters the player cabinet, take the player to a trained technician for inspection.
- This compact disc player uses a laser to read the music on the disc. The laser mechanism corresponds to the cartridge and stylus of a record player. Although this product incorporates a laser pick-up lens, it is completely safe when operated according to directions.

- Discs rotate at high speed inside the player. Do not use damaged, warped, or cracked discs.
- Do not touch the pick-up lens which is located inside the disc tray. To keep dust from collecting on the pick-up lens, do not leave the tray door open for an extended period of time. If the lens becomes dirty, clean it with a soft brush, or use an air blower brush designed for camera lenses.
- The apparatus shall not be exposed to dripping or splashing and that no objects filled with liquids, such as vases, shall be placed on the apparatus.
- Minimum distances around the apparatus for sufficient ventilation .
- The ventilation should not be impeded by covering the ventilation opening with items, such as newspaper, table-cloths, curtains, etc.
- No naked flame sources, such as lighted candles, should be placed on the apparatus.
- Attention should be drawn to the environmental aspects of battery disposal.

Important Battery Information

- Remove the batteries to avoid leakage if you do not use your remote control for more than one month.
- Discard leaky batteries immediately as leaking batteries may cause skin burns or other personal injuries. Dispose of batteries in the proper manner, according to provincial and local regulations.
- Any battery may leak electrolyte under the following circumstances:
 - if mixed with a different battery type,
 - if inserted incorrectly,
 - if all batteries are not replaced at the same time,
 - if disposed of in fire, or
 - if an attempt is made to charge a battery not intended to be recharged.

Please Respect the Environment!

Before throwing any batteries away, consult your distributor who may be able to take them back for specific recycling.

Don't Infringe

This product should only be used for the purposes for which it is sold, that is, entertainment, violating no copyright law. Any attempts to use this product for which it is not intended is unlawful and therefore not condoned by Thomson.

Headphone Safety

Make sure you turn down the volume on the unit before you put on headphones. Increase the volume to the desired level only after headphones are in place.

**EN**

Portions based upon Microsoft Windows Media Technologies.

Copyright © 1999 Microsoft Corporation. All Rights Reserved. Microsoft, Windows Media, and the Windows Logo are trademarks or registered trademarks of Microsoft Corporation in the United States and/or other countries.

iPod is a trademark of Apple Computer, Inc., registered in the U.S. and other countries.

The descriptions and characteristics given in this document are given as a general indication and not as a guarantee. In order to provide the highest quality product possible, we reserve the right to make any improvement or modification without prior notice. The English version serves as the final reference on all products and operational details should any discrepancies arise in other languages.

Contents

EN

Getting Started	2	Recording to the USB drive	11
Content of Box		An Overview	
Connections		Recording CD/Tuner/AUX to USB drive 12
General Controls	4	Deleting Files from USB drive	
Main Unit		Deleting All Files	
Remote Control	5	iPod Mode	13
Display and Settings	7	Connecting iPod Dock	
Setting the Clock/Timer		Playback Features	
Sleep Mode		Charging your iPod	
Sound Features	8	Advanced Playback Controls	14
Volume Control		Intro/ Repeat/Random	
Bass Boost and Equalizer		Setting Up a Program List	
CD and mp3 Disc Playback	8	Rename Tracks	15
USB Playback	10	Advanced Navigation Controls ..	15
Connecting USB device to the Main Unit		File Navigation	
Selecting USB Mode		Main Unit	
USB Playback Features		Remote Control	16
Memory Usage		Display	
Radio	10	Tips on Playback Sequence of Disc	17
Selecting Tuner Mode		Troubleshooting Tips	18
Selecting Tuner Band		Maintenance	19
Tune Mode and Preset Mode		Cleaning	
Tune Mode		Handling CDs	
Preset Mode		CD Lens Care	
Suppressing Stereo Signal	11	Technical Specification	
		Limited Warranty	21

Getting Started

Content of Box

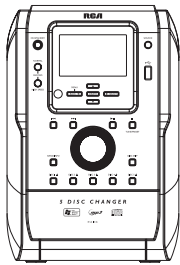

one main unit

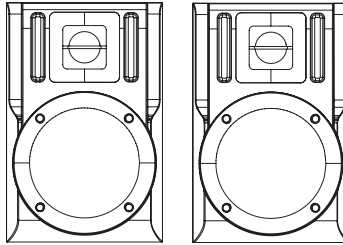

two main speakers

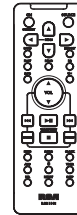

one remote control
with batteries



one AM loop antenna

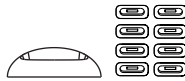

one iPod dock and
eight adapters

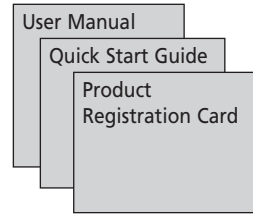

Connections of Antennas and Speakers

1. iPod dock socket.
2. AM Loop antenna Jack.
3. FM Pigtail Antenna.
4. AUX IN.
5. Main Speaker Jacks.

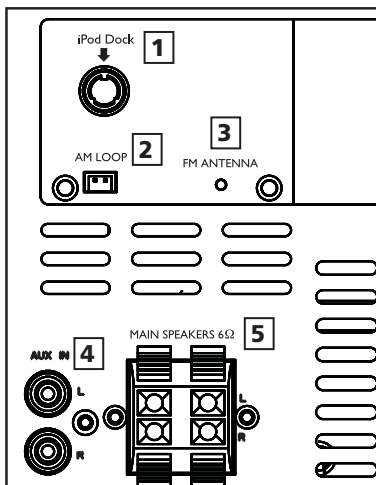

Using the FM and AM Antennas

Before you use your unit, ensure both the FM and AM antennas are positioned properly.

Uncoil the FM antenna at the back of the unit, ensuring it is fully extended (you may even want to tape it to the wall behind the unit if possible. The higher the better.) You'll also need to connect the AM antenna loop to the back of the unit if you listen to AM stations. Rotate the AM loop antenna for better reception.

Connecting the Speakers

Each speaker has a black and a red wire. When connecting the speakers, match the red wires to the red jacks and the black wires to the black jacks.

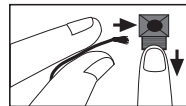

Push Speaker terminal tab
down to insert wire.



Release tab to lock wire in
the terminal.

NOTE: Ensure the insulation is completely removed from the ends of the speaker wires at all connection points.

EN

Getting Started

Installation

To ensure sufficient ventilation, keep the space shown below free from other surfaces:

EN

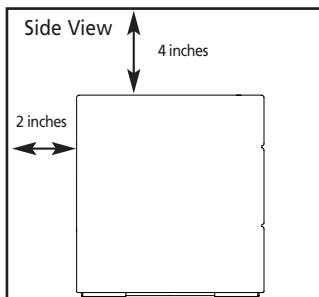
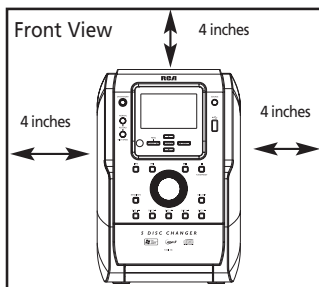









iPod Compatibility

Made for:

- iPod with video (30GB, 60GB, 80GB) **5th/5.5th generations**
- iPod photo (20GB U2 Special Edition, 30GB U2 Special Edition, 40GB, 60GB) **4th generation**
- iPod (10GB, 15GB, 20GB, 20GB U2 Special Edition, 30GB, 40GB) **3rd & 4th generations**
- iPod nano (1GB, 2GB, 4GB, 8GB) **1st & 2nd generations**
- iPod mini (4GB, 6GB) **1st & 2nd generations**

Connecting iPod Dock

1. Check the table and use the appropriate adaptor for your iPod.

iPods	Adaptors
 iPod mini 4GB / 6GB	3
 iPod 20GB & U2 Special Edition (4th Generation)	4
 iPod 40GB (4th Generation)	5
 iPod photo & color U2 iPod iPod with color display 20GB / 30GB	6
 iPod photo iPod photo with color display 40GB / 60GB	7
 iPod nano 2GB / 4GB	8
 iPod with video 30GB	9
 iPod with video 60GB	10

2. Install the correct adaptor to the dock.
3. Connect the cable from the iPod dock to the iPod dock socket at the back of the unit.

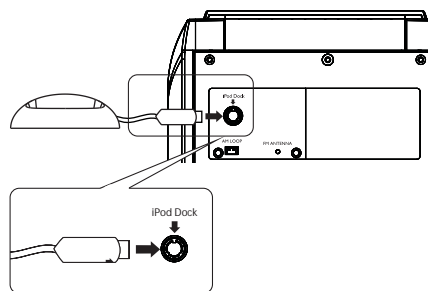

Note: This model includes adaptors for most of the common iPod models. If you have an iPod that requires a different adaptor, use the adaptor shipped with your iPod.

General Controls

Main Unit - Front View

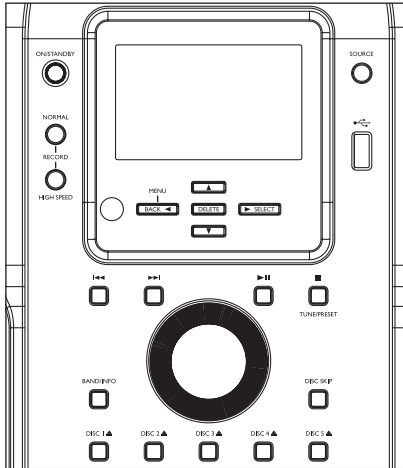

ON/STANDBY

- Turns power on or off (STANDBY mode).

SOURCE

- Allows selection of the following modes: CD player, Tuner, iPod, USB and AUX.

USB Jack

- Connects the USB drive.

DISC 1 ▲ /DISC 2 ▲ /DISC 3 ▲ /DISC 4 ▲ /DISC 5 ▲

- Opens or closes the corresponding disc tray.

PLAY/PAUSE ►►

- *In the CD, USB or iPod mode*, it starts and pauses playback.

TUNE/PRESET ■

- *In the CD or USB mode*, it stops playback.
- *In Recording mode*, it stops recording to USB drive.
- *In Tuner mode*, it selects tune or preset mode.

FAST REVERSE/FORWARD ◀◀ / ▶▶

- *In CD, USB or iPod mode*, press to go to the previous/next track; hold to fast forward or reverse through track.
- *In Tuner mode*, it tunes the radio.

BAND/INFO

- *In CD or USB mode*, it displays various information. e.g. Track time, remaining time, ID3 tag, memory usage etc.
- *In Recording mode*, it selects display options and show record time and remaining time.
- *In Tuner mode*, it selects radio band.

RECORD – NORMAL

- Starts and stops recording to the USB drive in normal speed.

RECORD – HIGH SPEED

- Starts and stops recording to the USB drive in high speed.

DELETE

- Deletes the selected item.

DEMO (on top of the unit)

- Turns the demonstration on/off.

File Navigation Buttons

Use the following file Navigation buttons to navigate through the menu.

SELECT ►

- *From the stop mode*, it selects Navigation mode.
- *In the Navigation mode*, it moves forward and selects highlighted item.

BACK ◀ /MENU

- *In the Navigation mode*, it navigates backwards.

DELETE

- When reviewing program, it removes track from Program List.
- *In the USB mode*, it removes file from the connected USB drive.

VOLUME CONTROL

- *In the Navigation mode*, it moves up/down a list.
- *In Normal Mode*, it adjusts the volume.

▲ / ▼

- *In Navigation mode*, it moves up/down a list.

EN

General Controls

Remote Control

EN

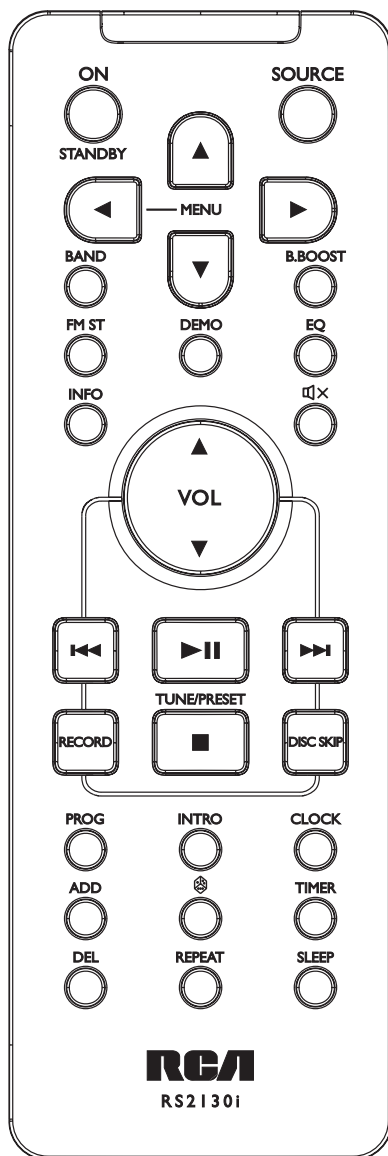

ON/STANDBY

- Turns the power on or off (STANDBY mode).

SOURCE

- Selects the CD player, Tuner, iPod, USB and AUX.

BAND

- In Tuner mode, it selects radio band.

FM ST

- Selects between stereo and mono sound in the FM tuner mode.

INFO

- In the CD or MP3/WMA mode, it displays various information (e.g. Track time, remaining time, ID3 tag, etc.)
- In the USB mode, it shows memory usage.

DEMO

- Turns the demonstration on/off.

B. BOOST

- Turns on or off the Bass Boost.

EQ

- Selects the equalizer presets.

MUTE

- Mutes the sound.

VOLUME CONTROL or

- Adjusts the volume of the sound.

PLAY/PAUSE

- In CD, iPod or USB mode, it starts and pauses playback.

FAST REVERSE/FORWARD /

- In the CD, USB or iPod mode, press to go to the previous/next track; hold to fast forward or reverse through track.
- In Tuner mode, it tunes down/up frequency.

RECORD

- Starts and stops recording to the USB drive in normal speed.

TUNE/PRESET ■

- *In CD or USB mode*, it stops playback.
- *In Recording mode*, it stops recording.
- *In Tuner mode*, it selects the Tune or Preset mode.

DISC SKIP

- Skips to the next disc in CD mode.

PROG

- *In CD, USB or Tuner mode*, it enters program mode.

INTRO

- *In CD or USB mode*, it turns intro mode on or off to play the first 10 seconds of each track/file.

CLOCK

- Displays clock time. Press and hold to enter clock setting mode.

RANDOM 🎲

- *In CD, USB, iPod or MP3/WMA mode*, it turns on/off random playback.

TIMER

- Hold to enter timer setting mode.
- Press to activate and deactivates timer.

REPEAT

- *In the CD mode*, it repeats a track, CD or all CDs.
- *In USB or iPod mode*, it selects repeat one file, repeat all files mode.

SLEEP

- Selects the time interval in minutes before the unit turns off.

ADD

- *In the CD or USB mode*, it adds track/file to the Program List.

DEL

- When reviewing program, it removes track from Program List.
- *In the USB mode*, it removes file from the connected USB drive.
- *In rename mode*, you can delete current alphabet.

File Navigation Buttons

Use the navigation buttons to navigate through menu.

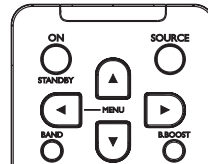

- From stop mode, enters Navigation mode.
- *In Navigation mode*, navigates forward and selects highlighted item.
- *In rename mode*, confirms the current alphabet and move to the next alphabet.



- *In Navigation mode*, can navigate backwards.
- *In rename mode*, edits the previous alphabet.



- *In Navigation mode*, it moves up/down a list.
- *In USB or simple MP3/WMA mode*, enters Navigation mode.
- *In rename mode*, selects alphabets.

Installing Batteries

Insert 2 "AAA" ("UM-4"/"R03") batteries to the remote control prior to use.

EN

Display and Settings

EN

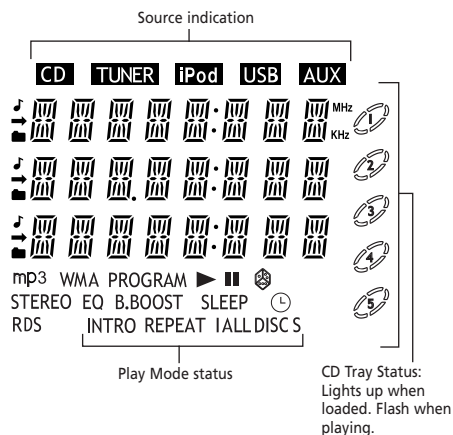

5. Press **TIMER** to select source. Press **◀** or **▶** to select TUNER/TUNER REC/DISC/USB/iPod. If TUNER REC is selected, press **◀** or **▶** to select the preset station.
6. Press **TIMER** to set volume. Adjust **VOLUME CONTROL** to select desired volume level.
7. Press **TIMER** to save settings. Press **TUNE/PRESET** **■** to cancel setting. The timer is automatically activated once timer setting is saved.

Activating the Timer

Press **TIMER** to turn on/off the alarm. The timer icon  is displayed when timer is activated.

Setting the Clock

1. Press and hold **CLOCK** on the remote control until the hour flashes on the display.
2. Press **◀** or **▶** to set the hour and then press **CLOCK** to shift to minute digits.
3. Press **◀** or **▶** to set the minute.
4. Press **CLOCK** to save settings. Or press **TUNE/PRESET** **■** to cancel the setting.

Sleep Mode

You can select the time interval in minutes before the unit turns off automatically.

Press **SLEEP** to select among OFF, 120, 90, 60, 45, 30, 15 and 5 minutes.

The SLEEP icon lights on the display when sleep mode is activated.

Timer and Program Recording

You can turn on/off the unit or record TUNER at preset times by setting the timer.

You can use Program Recording to preset the unit to record your favorite radio program. When setting the timer, choose TUNER REC as the source to record radio at the preset time. Ensure there is adequate memory in the USB device connected.

View and Adjust Remaining Sleep Time

When sleep is activated, press **SLEEP** once to view remaining sleep time. Press again to change the time.



Note: Sleep is automatically de-activated when the unit is turned off.

Setting the Timer

1. Press and hold **TIMER** on the remote control until Timer On and the clock hour flashes on the display.
2. Set the Timer ON setting. Press **◀** or **▶** to set the hour and then press **TIMER** to shift to minute digits.
3. Press **◀** or **▶** to set the minute.
4. Press **TIMER** to change to Timer Off setting with clock time flashing. Repeat steps 2 & 3 for timer off time setting.

Showing Demonstration

Press **DEMO** to turn on/off demonstration mode.



Sound Features

Volume Control

Turn the volume control on the main unit or press **VOL** ▼ or ▲ on the remote control to adjust volume level. The volume level shows briefly on the display.

Bass Boost

Press **B.BOOST** to turn on/off boosting the bass frequency. The **BASS BOOST** icon displays when it is activated.

Muting Sound

Press **MUTE** on the remote to mute the sound. When **MUTE** is on, the symbol flashes.

Using Preset Equalizer Curves

Press **EQ** to toggle among **FLAT**, **ROCK**, **POP**, **JAZZ**, **CLASSIC** and **CUSTOM**. The display shows your selection briefly and the relative icon lights on the display.

EN

Creating a Custom Curve

1. Press **EQ** to select **CUSTOM** mode.
2. While **CUSTOM** is displayed, press **◀** or **▶** to cycle among displayed bass and treble range levels.
3. While **BAS** and **TRE** is displayed, adjust volume control to set the associated gain between -10 - +10.
4. Press **EQ** to save setting and exit.

CD and mp3 Disc Playback

Loading Discs

1. Press **DISC 1** ▲ / **2** ▲ / **3** ▲ / **4** ▲ / **5** ▲ on the main unit to open the desired disc tray.
2. Insert a disc with label face up.
3. Press the same **DISC** ▲ key to close the disc tray, or press a different **DISC** ▲ key to open a different disc tray directly.
4. Repeat steps 2-4 to load discs in all the disc trays.

The occupied disc tray icons displays and the current disc icon flashes on the display. If the disc is a mp3/WMA CD, the respective **MP3** and **WMA** icon will be displayed.

Play Discs

To play all discs in the disc tray

Press **▶▶** in stop mode to begin playback.

To play a specific disc in the disc tray

Press **DISC SKIP** to skip to the desired disc.

To play a specific track in the disc

Press **◀** or **▶** to select the track and press **▶▶** to start playback.

Pause Discs

Press **▶▶** during playback to pause disc. Press again to resume.

Play and load simultaneously

While playing one disc, you can press **OPEN/CLOSE** ▲ to open or close other disc trays to load or change disc without interrupting the playback.

Stop Playback

During playback, press **TUNE/PRESET** ■ to stop playback.

The unit returns to Navigation mode briefly (around 10 seconds) before entering stop mode.



Tip:

- In Tuner iPod, USB or AUX mode, the corresponding disc will start playback when **DISC 1** ▲ / **2** ▲ / **3** ▲ / **4** ▲ / **5** ▲ is pressed. If there is no disc in the corresponding disc tray, the current disc will be set to the next occupied tray.



CD and mp3 Disc Playback

Selecting a Disc

Press **DISC SKIP** to skip discs.

EN

Fast Forwarding/Reversing/ Skipping Tracks

- Press and hold **◀◀** or **▶▶** to fast forward or reverse through a CD while it is playing.
- Press **◀◀** or **▶▶** to skip to the previous or next track.

Program Playback

Refer to page 14 for details.



Notes:

- See pages 15 – 16 for details on Navigation Mode.
- In CD stop mode, press **SELECT/▶** to enter Navigation mode and show disc menu. In CD Navigation mode, press **◀/BACK** to return to stop mode.
- Be sure to remove all discs from the disc tray before moving or transporting the unit.
- Do not force the tray to close during CD playback or tray opening.
- File formats/bitrates supported by the player:
mp3: 32 to 320kbps
wma: 48 to 160kbps

into the unit. This may take a longer time to read the disc.

- Playback capability for CD-RW discs may vary due to variations in the quality of the CD-RW disc and the recorder used to create the disc.

Notes on mp3/WMA Disc:

- Use .mp3 as the extension when converting audio files into mp3 for saving onto CD-R(W) or CD-ROM, e.g. Abc08.mp3. Do not use any other extension e.g. .doc, .pdf.
- Do not use the .mp3 extension for other text or non-audio data files as this may result in serious malfunction and harmful noise interference.
- For better quality mp3/WMA disc playback, the CD quality should be recorded at 128kbps or 64kbps.
- Disc data size > 650MB is not recommended.
- Total files and folders in the disc should not exceed 250, it also depends on the length of the file/folder names.
- For mixed mode discs, only one mode will be selected for playback depending on the recording format.
- To ensure good performance, wait until the disc changer completely reads the disc before proceeding.
- mp3 files in CD ROM EXTRA format disc are not recognized.

Important CD and mp3/WMA Information

Notes on CD-R/RW Disc:

- Some CD-R and CD-RW discs may not be playable due to the state of the disc or the device that was used for recording.
- Do not affix any type of labels to either side (recordable or labeled side) of a CD-R/RW disc as this may result in the unit malfunctioning.
- To avoid damages to the CD-R/RW disc, do not open the disc tray door while the disc is being read.
- Do not load an unrecorded CD-R/RW disc

USB Playback

Connecting USB drive to the Main Unit

Insert the USB drive's connector into the main unit's USB Jack on the front panel. To disconnect, unplug the drive.

Selecting USB Mode

Press **SOURCE** repeatedly to select USB mode.

USB Playback Features

Start and Pause Playback

Press **▶||** to start and pause playback.

Stop Playback

Press **TUNE/PRESET** **■** to stop playback. The unit enters the Navigation mode for 10 seconds before entering the stop mode.

Skipping Files/Fast Forwarding/Reversing

- Press **◀◀** or **▶▶** to skip to the previous or next file.
- Press and hold **◀◀** or **▶▶** to fast forward or reverse through a file while it is playing.

EN

Memory Usage

Press **BAND/INFO** on the main unit or **INFO** on the remote control to view memory usage on the USB drive.



Note: Mass Storage Class (MSC) USB devices of up to 20 GB are compatible with this unit. Do not connect other USB devices to this unit.

Radio

Selecting Tuner Mode

Press **SOURCE** to enter Tuner mode.

Selecting Tuner Band

In Tuner mode, press **BAND** to select between FM or AM Radio band.

Tune Mode and Preset Mode

The tuner can be in either **TUNE** or **PRESET** mode.

- To select between TUNE and PRESET mode, press **TUNE/PRESET** **■**.
- In PRESET mode, "P XX" will be displayed where "XX" represents the preset number (1-32).

Tune Mode

In **TUNE** mode, you can press **◀◀** or **▶▶** to select desired frequencies.

- Press **◀◀** or **▶▶** to select frequencies.
- Press and hold **◀◀** or **▶▶** to scan frequencies.

Preset Mode

In **PRESET** mode, the unit can store up to 32 radio stations in its memory. You can program the presets in two ways:

- Manually setting the by entering every single radio station yourself.
- Perform Auto Preset Programming and the unit can store all available radio stations automatically in ascending order.

Manually Setting Presets

1. Press **TUNE/PRESET** **■** to enter TUNE mode.
2. Press **◀◀** or **▶▶** to adjust the desired frequency.
3. Press **PROG** once and the most recently accessed program location flashes on the display.
4. If a different program location is preferred, press **◀◀** or **▶▶** to move to the desired preset number (1-32).
5. Press **PROG** to store the selected frequency at that preset.

Auto Preset Programming (FM only)

Press and hold the **BAND** button for 2 seconds to scan stations in the FM band. The stations will then be stored as preset channels. A maximum of 32 stations can be stored. Be careful of your preset channels being erased accidentally because the scanning and storing process is automatic upon pressing the button. You can stop the automatic scan by pressing any button, but the erased stations cannot be recovered.

Radio

Using Presets

- When in **PRESET** mode, press **◀◀** or **▶▶** to access the previous or next preset station.

EN



Tip: Under **PRESET** mode, press **◀◀** or **▶▶** can only access the preset stations. Manual tuning is not available in this mode.

Suppressing Stereo Signal

Press **FM ST** on the remote control to select between FM mono and stereo mode. **STEREO** is displayed in stereo mode.

Recording to the USB drive

An Overview

- You can record CD, Tuner or AUX files to the MSC device which connected to the USB Jack.
- Recording function **always** records what is being played. Press **SOURCE** to select the source you want to record from.
- In general, recording starts instantly when **RECORD** is pressed. It stops when **TUNE/PRESET** ■ or **RECORD** is pressed.
- During recording, **REC** icon lights.
- There is one exception where recording will not start immediately when **RECORD** is pressed — while in CD mode and the CD is NOT playing. In this case, the unit goes into Recording Standby Mode, which is indicated by the flashing recording icon. This is to avoid recording "silence" to the USB device.
- The unit will go from Recording Standby Mode to Recording Mode as soon as the CD starts playing.

Normal/High Speed

- High speed recording is only available for CD to USB drive recording.
- When **RECORD – NORMAL** on the main unit or **RECORD** on the remote control is pressed, it records the CD in real time as it plays.
- When **RECORD – HIGH SPEED** on the main unit is pressed, it records the CD at roughly double the normal speed. No sound could be heard during this process.
- Through out the following recording operations, simply press **RECORD – HIGH SPEED** instead of **RECORD – NORMAL** on the main unit or **RECORD** on the remote control if you want to record at high speed.

Recording CD to USB drive

Recording Standby/Selecting Recording Speed

1. Connect the USB drive to the unit's USB jack.
2. In CD stop mode, press **RECORD – NORMAL** on the main unit or **RECORD** on the remote control.
3. The unit is now in Recording Standby Mode with **REC** icon flashing. Turn **VOLUME CONTROL** knob or press **▲**, **▼**, **◀** or **▶** to select the track to be recorded.
4. Press **▶▶** or **RECORD** to start recording. The **REC** icon displays.
5. Press **TUNE/PRESET** ■ or **RECORD – NORMAL** on the main unit or **RECORD** on the remote control to stop recording.

Recording any passage from a CD

1. Play the CD.
2. Press **RECORD – NORMAL** on the main unit or **RECORD** on the remote control when you want to start recording.
3. Press **TUNE/PRESET** ■ or **RECORD – NORMAL** on the main unit or **RECORD** on the remote control when you want to stop recording. You can start whenever you want.

Record all 5 CDs

Repeat steps 1 to 4 under "Recording Standby/Selecting Recording Speed" on this page. Press **REPEAT** until "ALL DISCS" is displayed. (See page 14 for more details on playback control.)



Record only selected tracks from a CD

1. Create a CD program by following the instructions under "Setting Up a CD Program" on page 14.
2. In CD stop mode, press **PROG** to enter Program mode.
3. Press **RECORD – NORMAL** on the main unit or **RECORD** on the remote control. Playback and recording should begin automatically. The **PROGRAM** and **REC** icons will light on the display.
4. Recording stops automatically when the program is finished.

Recording Tuner/AUX to USB drive

1. In Tuner mode, select the station to record (refer to page 10 – 11 for details).
2. Press **RECORD – NORMAL** on the main unit or **RECORD** on the remote control to start recording.
3. Press **TUNE/PRESET** \blacksquare or **RECORD – NORMAL** on the main unit or **RECORD** on the remote control to stop recording.

Program Recording

Refer to "Setting the Timer" on page 7.

Deleting Files from USB drive

1. In USB Navigation mode, select the file for deletion using the navigation buttons (Refer to "Advanced Navigation Controls" on page 15 for details.)
2. Press **DELETE** on the main unit or **DEL** on the remote control.
3. Turn **VOLUME CONTROL** knob on the main unit or press \blacktriangle or \blacktriangledown on the remote control to select Yes to delete or No to cancel.
4. Press **SELECT** on the main unit or press \blacktriangleright on the remote control to confirm selection. If Yes is selected, the display shows memory usage information after deleting selected file. For a few seconds, the unit will return to the Navigation mode.

Deleting All Files

In Navigation and mp3 stop modes, press and hold **DELETE** on the main unit, or press **DEL** on the remote control to delete all the files on the USB drive.



Tips:

- If CD playback has already started, recording will begin instantly when **RECORD – NORMAL** or **RECORD – HIGH SPEED** on the main unit or **RECORD** on the remote control is pressed. If CD playback is stopped, press **RECORD – NORMAL** or **RECORD – HIGH SPEED** on the main unit or **RECORD** on the remote control and then \blacktriangleright to start recording. Recording will not start until CD starts playback.
- Recording stops automatically when CD stops.
- To view recording time and remaining time, press **BAND/INFO** on the main unit or **INFO** on the remote during recording.

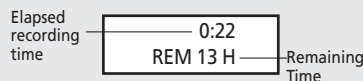

- The encoding bitrate for tuner, CD and AUX signal are:
CD/Aux: 128 kbps
Tuner: 96 kbps

EN

iPod Mode

EN

In iPod mode, you can navigate and playback music on your iPod.

Connecting your iPod to the Unit

- Ensure the iPod dock is connected to the unit as described on page 3.
- Turn off your iPod or put it in Pause Mode.
- Place the iPod on the iPod dock and press **SOURCE** to select iPod mode.
- "iPod Connecting" displays on the main unit. "iPod not found" will be displayed if no iPod is connected to the unit. Playlists, Artists, Albums and Genre will be displayed if the connection is successful.
- Once connected, the iPod will resume playback from where it last stopped.

Navigate and Playback Audio Files on your iPod

Once docked, the iPod's own display and buttons will be disabled. Navigate and playback your iPod using the unit's buttons and remote control.

The iPod's user interface (UI) is copied to the unit allowing you to experience the same control as the iPod's own control.

iPod Control	Main Unit	Remote
Click Wheel	VOLUME CONTROL knob	VOL ▼ or ▲
Menu button	BACK/MENU button	◀ /MENU button
Center button	SELECT button	▶
▶	▶	▶
◀◀ / ▶▶	◀◀ / ▶▶	◀◀ / ▶▶

Shuffle and Repeat Modes

You control the shuffle and repeat modes by pressing  and **REPEAT** on the remote control.

Auxiliary Functions of the iPod

Non-music functions of the iPod, such as photo, video, stopwatch, game will be disabled when the iPod is docked to the unit.

Charging your iPod

Your iPod is charged whenever it is docked to the main unit.

Disconnecting your iPod

Stop the iPod playback before disconnecting it from the dock.



Notes:

- This model includes adapters for most of the common iPod models. If you have an iPod that requires a different adapter, use the adapter shipped with your iPod.
- Do not connect your iPod to the main unit's USB jack. It is recommended to connect your iPod to the iPod dock provided.

Advanced Playback Controls

In CD and USB mode, advanced playback controls allow you to sample, repeat and random playback files and set up a Program List. In USB mode, it allows you to rename tracks.



Sampling Tracks

Press **INTRO** on the remote control to play the first 10 seconds of each track on the current disc, all discs in the tray, or turn intro mode off. **INTRO** is displayed when sampling is activated.

Repeat

Press **REPEAT** on the remote control to toggle repeat options:
 Repeat the current track (REPEAT 1),
 Repeat all tracks in USB mode (REPEAT ALL),
 Repeat current disc (REPEAT 1 DISC),
 Repeat all discs (REPEAT ALL DISC), or
 Normal playback (ALL DISCS).

Random Playback

Press  on the remote control to turn on/off random playback.  is displayed when it is activated.

All the tracks on one disc will be shuffled and played once before shuffling and playing tracks from the next disc.



Tip: Random playback can be activated simultaneously with repeat 1 disc (randomly play tracks from one disc repeatedly) or repeat all discs (randomly play tracks from all discs repeatedly).

Setting Up a Program List

1. In the Navigation mode, press **DISC SKIP** to select disc.
2. Use the navigation buttons to select the track to add to Program List.
3. Press **ADD** on the remote control to add selected track into the next available program location.
4. Repeat steps 1 to 3 to store more tracks into program memory.
5. Wait for a few seconds timeout to return to Navigation mode.



Notes:

- You can create a program of up to 32 tracks.
- In CD stop mode, press **PROG** to toggle between the program mode and normal modes.

Playing a Program List

Press **PROG** to enter program mode and then press **▶**. Program playback will begin. **PROGRAM** is displayed.

Display Program List

1. While the CD playback is stopped, press **PROG** to enter PROGRAM mode. To display program list, press **TUNE/PRESET**.
2. Press **▲** or **▼** repeatedly to view each track assignment in the program list.

Deleting from Program List

1. While in PROGRAM mode, press **▲** or **▼** to select the program to delete.
2. Press **DELETE** on the unit or **DEL** on the remote control.
3. Press **▲** or **▼** to select between "No" to cancel and "Yes" to confirm.
4. Press **▶** to confirm selection.

Deleting the Entire Program List

Follow the above steps by pressing and holding **DELETE** on the unit or **DEL** on the remote control instead of pressing and releasing.

EN

Advanced Playback Controls

Renaming Tracks

EN

You can rename files in the USB drive.

1. In the USB stop mode, press ◀ or ▶ to select folder.
2. Press ◀ or ▶ to select the file in the current folder.
3. Press **PROG** to enter rename mode.
4. Press ▲ or ▼ or **VOLUME CONTROL** to select the first letter of the new file name.
5. Press ▶ to confirm the current letter and move to the next letter.
6. Press ◀ to modify the previous letter.
7. Press **PROG** again to confirm and store the new file name after entering the last letter of the file name (maximum seven letters).



Notes:

- You can only rename the files but not the folders.
- You need to enter a folder and select a file you want to rename before pressing **PROG**. If you press **PROG** while you are navigating the folders, "NO PROG" will be displayed.

Advanced Navigation Controls

File Navigation

Main Unit

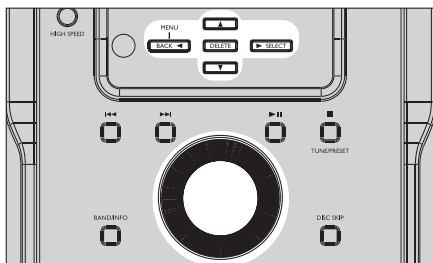

SELECT

- *From stop mode*, enters Navigation mode.
- *In Navigation mode*, plays selected track or enters selected folder.

BACK

- *In Navigation mode*, exits current folder and return to a higher level.

DELETE

- Deletes the selected item.

VOLUME CONTROL

- Adjusts volume.
- *In Navigation mode*, selects items on a list.

▲/▼

- *In Navigation mode*, it moves up/down a list.

Remote Control

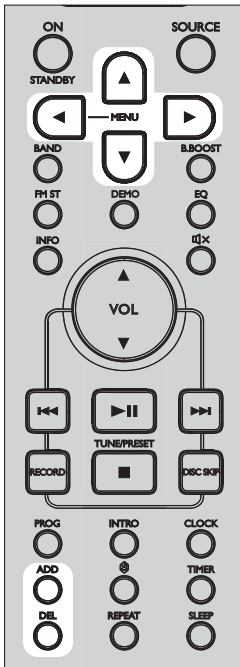

EN

- ▶
- *From stop mode*, enters Navigation mode.
- *In Navigation mode*, plays selected track or enter selected folder.
- ◀
- *In Navigation mode*, exits current folder and return to a higher level.
- ▲ / ▼
- *In Navigation mode*, moves up/down a list.
- *In tuner mode*, selects the previous or the next preset number.

ADD

- *In CD, USB or MP3/WMA mode*, adds track/file to the Program List.

DEL

- When reviewing program, it removes track from Program List.
- *In USB mode*, it removes file from the connected USB drive.

Display

In the Navigation mode, the display looks like the following with the highlighted item.

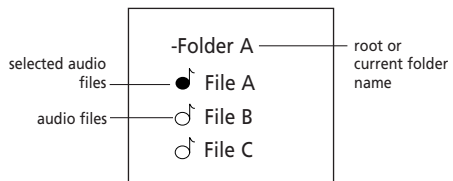
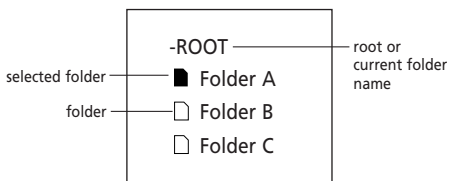

Advanced Navigation Controls



Tips on Playback Sequence of Disc

EN

- Check that the mp3/WMA disc is created with a single folder structure. Refer to the diagram below for playback sequence details on multi-level folder structure.
- For example, the folders and songs from level 2 are played before moving to play folders and songs from level 3.
- Folder playback sequence is indicated by the letters A to G.
- Song playback sequence is indicated by the numbers (1 to 15) in front of the song name.

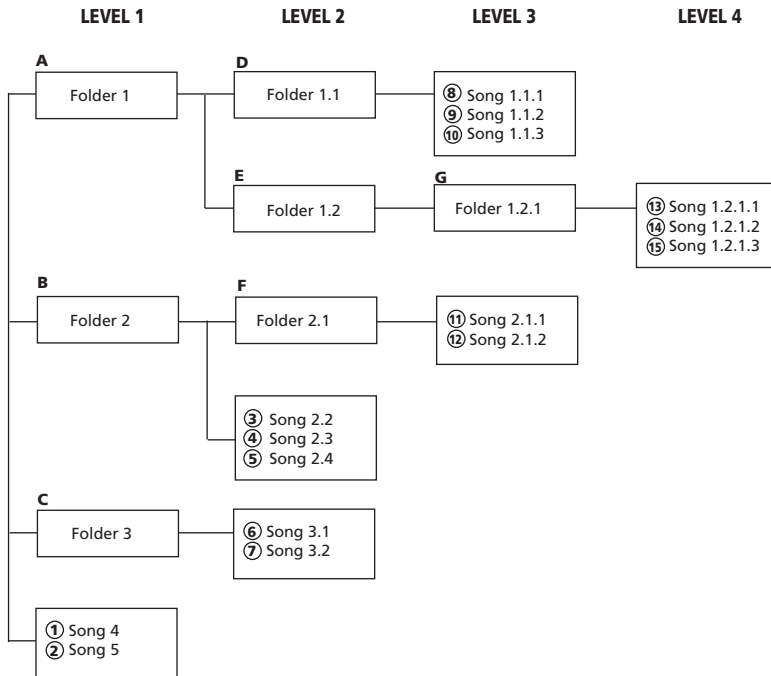

Troubleshooting Tips

Unit will not turn on

- Check the power cord for a secure connection.
- Unplug the unit for a moment, and then plug into power source again.
- Check the outlet by plugging in another device.

No sound

- Increase the volume setting.
- Check the connection to speakers.
- Check that you have selected the appropriate function: CD, Tuner.
- Make sure the mute is off.
- Make sure the headphones are not plugged in.

Poor radio reception

- Check the antenna connection.
- Move antenna.
- Turn off nearby electrical appliances, such as hair dryer, vacuum cleaner, microwave and fluorescent lights.

CD does not play

- Check that the CD is in the tray.
- Check that the CD label is facing up.
- Check that PAUSE mode is not on.
- Check that the CD function is selected.
- Use the CD lens cleaner.
- Clean the disc.
- Try another CD.

CD sound skips

- Clean the disc.
- Check the disc for warping, scratches, or other damage.
- Check if something is causing the unit to vibrate. If so, move the unit.
- Make sure the speakers are at least 3 feet away or on a different surface from the main unit.

CD button will not respond, or does not change discs when you press DISC SKIP

- Switch to another function (Tuner) and then back to CD.

Remote control does not work

- Check that the batteries are properly installed.
- Replace any weak batteries.
- Check the unit is plugged into power source.
- Point the remote directly at the unit's front panel.
- Move closer to the unit.
- Remove any obstacles between the remote and the unit.

EN

Maintenance

EN

Disconnect the unit from the power source before performing any maintenance.

Cleaning

Clean the exterior of the unit using a soft dust cloth.

CD Player

CAUTION! This unit operates with a laser. It must be opened by only a qualified technician.

Handling CDs

- Do not touch the signal surfaces. Hold the CD by the edges, or by one edge and the hole.
- Do not affix labels or adhesive tapes to the label surfaces.
- Do not scratch or damage the label.
- Do not use damaged (cracked or warped) CDs

Cleaning CDs

- Dirty CDs can cause poor sound quality. Always keep CDs clean by wiping them gently with a soft cloth from the inner edge toward the outer perimeter.
- If a CD becomes dirty, wipe the dirt away gently with a soft damp cloth and then remove any water droplets with a dry cloth.
- Do not use record cleaning sprays or antistatic agents on CDs. Also, never clean CDs with benzene, thinner, or other volatile solvents which may cause damage to the disc surface.

CD Lens Care

When your CD lens gets dirty it can cause the unit to output poor sound quality. To clean the lens you will need to purchase a CD lens cleaner to maintain the output sound quality of your unit. For instructions on cleaning the CD lens, refer to the ones accompanying the lens cleaner.

Technical Specification

Power supply: 120V~60Hz
 Dimensions (H x W x D mm):
 Unit size: 270 x 204 x 307
 Speaker: 270 x 198 x 236
 CD player: Response curve (+/- 2dB): 60Hz to 5kHz
 Rating Plate: Look for it at the back of the set.

Maximum size of Mass Storage Class device supported: 20 GB

Limited Warranty (U.S.)

What your warranty covers:

- Defects in materials or workmanship.

For how long after your purchase:

EN

- One year from date of purchase.
- The warranty period for rental units begins with the first rental or 45 days from date of shipment to the rental firm, whichever comes first.

What we will do:

- Provide you with a new, or at our option, a refurbished unit. The exchange unit is under warranty for the remainder of the original product's warranty period.
- Proof of purchase in the form of a bill of sale or receipted invoice which is evidence that the product is within the warranty period must be presented to obtain warranty service. For rental firms, proof of first rental is also required.

How to make a warranty claim:

- Properly pack your unit. Include any cables, etc., which were originally provided with the product. We recommend using the original carton and packing materials.
- Include evidence of purchase date such as the bill of sale. Also print your name and address and a description of the defect. Send via standard UPS or its equivalent to:

**Thomson Inc.
Product Exchange Center
11721 B Alameda Avenue
Socorro, Texas 79927**

- Insure your shipment for loss or damage. Thomson accepts no liability in case of damage or loss en route to Thomson.
- Pay any charges billed to you by the Exchange Center for service not covered by the warranty.
- A new or refurbished unit will be shipped to you freight prepaid.

What your warranty does not cover:

- Customer instruction. (Your Owner's Manual provides information regarding operating Instructions and user controls. For additional information, ask your dealer.)
- Installation and set-up service adjustments.
- Batteries.
- Damage from misuse or neglect.
- Products which have been modified or incorporated into other products.
- Products purchased or serviced outside the USA.
- Acts of nature, such as but not limited to lightning damage.

Product Registration:

- Please complete and mail the Product registration Card packed with your unit. It will make it easier to contact you should it ever be necessary. The return of the card is not required for warranty coverage.

Limited Warranty (U.S.)

Limitation of Warranty:

EN

- **The warranty stated above is the only warranty applicable to this product. All other warranties, express or implied (including all implied warranties of merchantability or fitness for a particular purpose) are hereby disclaimed. No verbal or written information given by inc., its agents or employees shall create a guaranty or in any way increase the scope of this warranty.**
- **Repair or replacement as provided under this warranty is the exclusive remedy of the consumer. Thomson Inc. Shall not be liable for incidental or consequential damages resulting from the use of this product or arising out of any breach of any express or implied warranty on this product. This disclaimer of warranties and limited warranty are governed by the laws of the state of indiana. Except to the extent prohibited by applicable law, any implied warranty of merchantability or fitness for a particular purpose on this product is limited to the applicable warranty period set forth above.**

How state law relates to this warranty:

- Some states do not allow the exclusion nor limitation of incidental or consequential damages, or limitations on how long an implied warranty lasts, so the above limitations or exclusions may not apply to you.
- This warranty gives you specific legal rights, and you also may have other rights that vary from state to state.

If you purchased your product outside the USA:

- This warranty does not apply. Contact your dealer for warranty information.

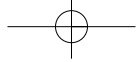

IMPORTADOR

Comercializadora Thomson de México, S.A. de C.V.
Álvaro Obregón No. 151. Piso 13.
Col. Roma. Delegación Cuauhtémoc
C.P. 06700. México, D.F.
Teléfono: 52-55-11-020360
RFC: CTM-980723-KS5



EXPORTER

Thomson Inc.
P.O. Box 1976
Indianapolis, IN 46206-1976
© 2007 Thomson Inc.
Trademark(s) ® Registered
Marca(s) ® Registrada(s)
Marque(s) ® Déposée(s)
www.rcaudiovideo.com
Printed In China / Impreso en China

5642192A (EN/E)



Free Manuals Download Website

<http://myh66.com>

<http://usermanuals.us>

<http://www.somanuals.com>

<http://www.4manuals.cc>

<http://www.manual-lib.com>

<http://www.404manual.com>

<http://www.luxmanual.com>

<http://aubethermostatmanual.com>

Golf course search by state

<http://golfingnear.com>

Email search by domain

<http://emailbydomain.com>

Auto manuals search

<http://auto.somanuals.com>

TV manuals search

<http://tv.somanuals.com>