



It's important to read this instruction prior to using your new product for the first time.

Safety Precautions

The following markings and symbols are located on the back of the unit.



This product contains a low laser device.

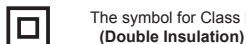

⚡ The lightning flash with an arrowhead symbol, within the equilateral triangle, is intended to alert the user to the presence of uninsulated "dangerous voltage" within the product's enclosure that may be of sufficient magnitude to cause an electric shock.

⚠ The exclamation point within the equilateral triangle is intended to alert the user to the presence of important operating and maintenance (servicing) instructions in this owner's manual.

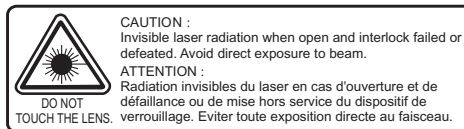

WARNING: CONNECTING SPEAKERS OTHER THAN THE SPEAKERS SUPPLIED WITH THE UNIT, MAY DAMAGE THE UNIT.

CAUTION: TO REDUCE THE RISK OF FIRE OR ELECTRIC SHOCK, DO NOT REMOVE COVER (OR BACK). NO USER-SERVICEABLE PARTS INSIDE. REFER TO QUALIFIED SERVICE PERSONNEL.

WARNING: TO PREVENT FIRE OR SHOCK HAZARD, DO NOT EXPOSE THIS APPLIANCE TO RAIN OR MOISTURE.

Safety Precautions

WARNING: THE APPARATUS SHALL NOT BE EXPOSED TO DRIPPING OR SPLASHING AND THAT NO OBJECTS FILLED WITH LIQUIDS, SUCH AS VASES, SHALL BE PLACED ON THE APPARATUS.

CAUTION: USE OF CONTROLS OR ADJUSTMENTS OR PERFORMANCE OF PROCEDURES OTHER THAN THOSE SPECIFIED MAY RESULT IN HAZARDOUS RADIATION EXPOSURE.

ON SAFETY

- Before operating, make sure the voltage requirement of the mains plug matches your local voltage.
- Disconnect the mains plug immediately if liquid spills into or onto the unit, or if an object falls into the unit. The unit should not be used until service by a qualified service personnel is completed.
- Do not open the cabinet. Lasers used in rays employed by the unit may damage your eyes. Any servicing should be done by qualified service personnel.
- When you are not going to use the unit for a long period of time, disconnect the mains plug.

ON PLACEMENT

- Do not leave, mount or use the unit in places which are extremely hot, cold, dusty, or humid.
- Allow adequate air circulation to prevent internal heat build-up. Do not place the unit on a surface or near materials (a curtain ex. rugs, blankets, curtains, etc.) which might block the ventilation holes.

ON CONDENSATION

- When left in a heated room where it is warm and damp, water droplets or condensation may form inside the CD player. When there is condensation inside the unit, the unit may not function normally. Let it stand for 1 to 2 hours before turning the power on, or gradually heat the room and allow the unit to dry before use.

FCC information

This device complies with part 15 of the FCC Rules. Operation is subject to the following two conditions: (1) This device may not cause harmful interference, and (2) this device must accept any interference received, including interference that may cause undesired operation. This equipment has been tested and found to comply with the limits for a Class B digital device, pursuant to part 15 of the FCC Rules. These limits are designed to provide reasonable protection against harmful interference in a residential installation. This equipment generates, uses and can radiate radio frequency energy and, if not installed and used in accordance with the instructions, may cause harmful interference to radio communications.

However, there is no guarantee that interference will not occur in a particular installation. If this equipment does cause harmful interference to radio or television reception, which can be determined by turning the equipment off and on, the user is encouraged to try to correct the interference by one or more of the following measures:

- Reorient or relocate the receiving antenna.
- Increase the separation between the equipment and receiver.
- Connect the equipment into an outlet on a circuit different from that to which the receiver is connected.
- Consult the dealer or an experienced radio / TV technician for help.

This Class B digital apparatus complies with Canadian ICES-003.

WARNING: Changes or modifications to this unit not expressly approved by the party responsible for compliance could void the user's authority to operate the equipment.

For your safety

The AC power plug is polarized (one blade is wider than the other) and only fits into AC power outlets one way. If the plug won't go into the outlet completely, turn the plug over and try to insert it the other way. If it still won't fit, contact a qualified electrician to change the outlet, or use a different one. Do not attempt to bypass this safety feature.



Important Safety Instructions

Some of the following information may not apply to your particular product; however, as with any electronic product, precautions should be observed during handling and use.

- Read these instructions.
- Keep these instructions.
- Heed all warnings.
- Follow all instructions.
- Do not use this apparatus near water.
- Clean only with a dry cloth.
- Do not block any ventilation openings. Install in accordance with the manufacturer's instructions.
- Do not install near any heat sources such as radiators, heat registers, stoves, or other apparatus (including amplifiers) that produce heat.
- Do not defeat the safety purpose of the polarized or grounding-type plug. A polarized plug has two blades with one wider than the other. A grounding type plug has two blades and a third grounding prong. The wide blade or the third prong is provided for your safety.
- If the provided plug does not fit into your wall outlet, consult an electrician for replacement of the obsolete outlet.
- Protect the power cord from being walked on or pinched particularly at plugs, convenience receptacles, and the point where they exit from the apparatus.
- Only use attachments / accessories specified by the manufacturer.
- Use only with a cart, stand, tripod, bracket, or table specified by the manufacturer, or sold with the apparatus. When a cart is used, use caution when moving the cart / apparatus combination to avoid injury from tip-over.



Portable Cart Warning

- Unplug this apparatus during lightning storms or when unused for long periods of time.
- Refer all servicing to qualified service personnel. Servicing is required when the apparatus has been damaged in any way, such as the power cord or plug is damaged, liquid has been spilled or objects have fallen into the apparatus, the apparatus has been exposed to rain or moisture, does not operate normally, or has been dropped.

General Controls

Front Panel

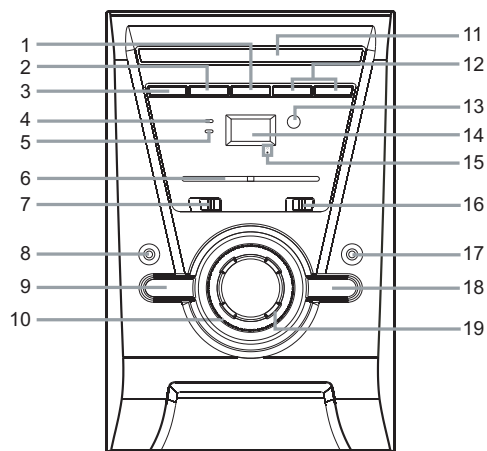

- 1. REPEAT Button**
Press to repeat one track / all tracks.
- 2. PROG (Program) Button**
Press to combine your favorite tracks and play them in the order you define.

- 3. Stop Button**
Press to stop playing a disc while in CD mode.
- 4. POWER ON Indicator**
Indicates when the unit is ON.
- 5. PROG (Program) Indicator**
When lit, it indicates that the unit is in programmable playback mode.
- 6. Radio Frequency Indicator**
Displays the current frequency selected.
- 7. Function Selector (STANDBY-TUNER-AUX-CD)**
- 8. Headphone Jack**
- 9. Play / Pause Button**
Press to start / pause playing a disc while in CD mode.
- 10. Tuning Knob**
Rotate this knob to tune in the desired station.
- 11. CD Drawer**
- 12. Skip / Search Buttons**
- 13. Remote Sensor**
- 14. CD Display**
- 15. Repeat Indicators (REPEAT ONE / REPEAT ALL)**
- 16. Radio Band Switch (AM-FM)**
- 17. LINE-IN Jack**
Connect the cable from external audio equipment to this jack.
- 18. Open / Close Button**
Press to open / close the disc door.
- 19. Volume Control Knob**
Rotate this knob to adjust the volume.

Remote Control

Remote Control (Only for CD Function)

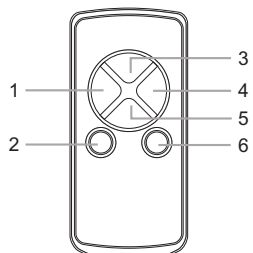

- 1. Skip / Search Buttons**
- 2. PROG (Program) Button**
- 3. Play / Pause Button**
- 4. Skip / Search Buttons**
- 5. Stop Button**
- 6. REPEAT Button**

USING THE REMOTE CONTROL CORRECTLY

- Point the remote control at the REMOTE SENSOR located on the unit.
- When there is a strong ambient light source, the performance of the remote's infrared may be degraded, causing unreliable operation.
- The operating range for remote operation is approximately 13 feet (4 m).

ATTENTION

- Remove the protective plastic tab before operating the remote control.

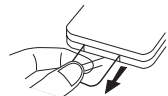

- **To change battery**

1. Open the battery door.
2. Insert one CR2025 (3V) size battery.

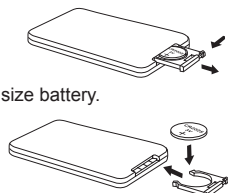

BATTERY REPLACEMENT

When the battery becomes weak, the operating distance of the remote control is greatly reduced and you will need to replace it.

CAUTION: Danger of explosion if battery is incorrectly replaced. Replace only with the same or equivalent type.

WARNING: Battery should not be exposed to heat such as sunshine, fire or the like.

Rear Panel

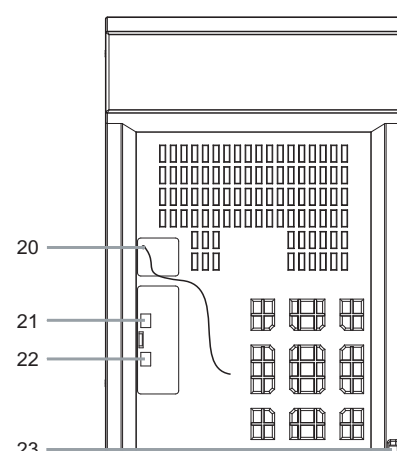

- 20. FM Antenna**
- 21. Right Speaker Connector**
- 22. Left Speaker Connector**
- 23. AC Power Cord**
Connect the AC power cord to the wall outlet.

System Connections

1. CONNECTING THE SPEAKERS

Connect the wires from the left & right speaker to the corresponding speaker terminals.

Note: Connecting speakers other than the speakers supplied with the unit, may damage the unit.

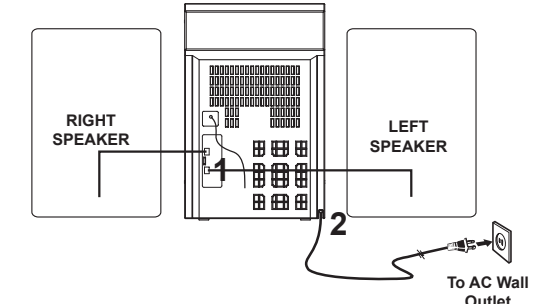

2. CONNECTING THE AC POWER CORD

Connect the AC power cord into a wall outlet.

Note:

- To prevent electric shock, match wide blade of AC power cord to wide slot of AC power outlet, then fully insert.
- When you are not going to use the unit for a long period of time, disconnect the AC power cord.

Radio Operations

1. Slide the FUNCTION selector to TUNER. The POWER ON indicator lights up.

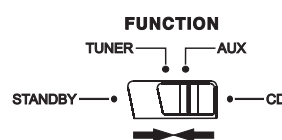

3. Tune into a station.

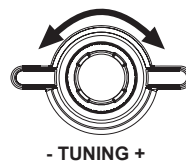

2. Slide the BAND selector to desired band (AM/FM).

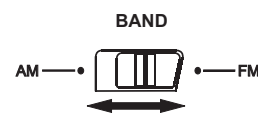

4. Adjust the volume level.

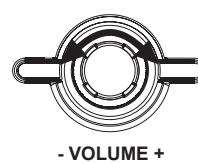

FOR BETTER RECEPTION

FM

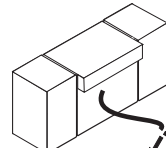

Fully unwind the wire antenna. Then extend the wire antenna and place it in the position that sounds best. (When the FM broadcast signal is strong, it can receive FM Stereo Broadcast.)

AM

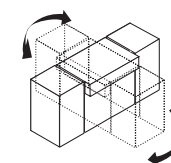

Rotate the unit to get the best receiving position.

NOTE: DO NOT CONNECT TO AN OUTSIDE ANTENNA.

AFTER LISTENING, slide the FUNCTION selector to STANDBY.

Compact Disc Playback

1. Slide the FUNCTION selector to CD. The POWER ON indicator lights up.

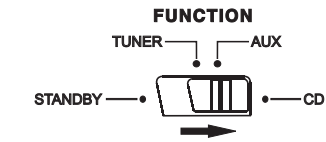

2. Press the **▲** to open the disc compartment.
 3. Place a disc onto the disc holder, with the label side up.
 4. Press the **▲** button again to close the CD door. The total number of tracks will show in the CD display for a few seconds.



5. Press the **PLAY/PAUSE** **▶||** button to start playback. The **•** symbol indicating playing will appear on the screen.

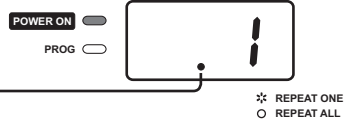

When this lights up, it indicates that the unit is playing a disc.
 If the disc playback is paused, it will flash.
 If the **STOP** **■** button is pressed, it will disappear.

TO STOP PLAYING:

- (a) Press the **PLAY/PAUSE** **▶||** button and the **•** indicator will flash. Press this button again to resume playing.
 (b) Press the **STOP** **■** button.

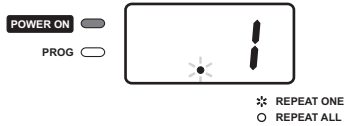

TO SKIP TO A DIFFERENT TRACK

- To skip to the beginning of the current track or previous track, press the **◀◀** button.
- To skip to the beginning of the next track, press the **▶▶** button.
- A short period of time will be needed for the disc to read the information of the desired track before playback can begin.

TO FAST FORWARD OR FAST REVERSE TO A PARTICULAR POINT

- To scan forward at high speed, press and hold the **▶▶▶** button and release it at the desired point.
- To scan backward at high speed, press and hold the **◀◀◀** button and release it at the desired point.
- Fast forward or fast reverse will continue searching the CD until it reaches the end.

REPEAT PLAYBACK DURING PLAYBACK MODE

To Repeat the Current Track

- Press the **REPEAT** **↻** button, the **•** indicator located in the right bottom corner of the screen will flash. The current track will be played repeatedly until the **STOP** **■** button is pressed.

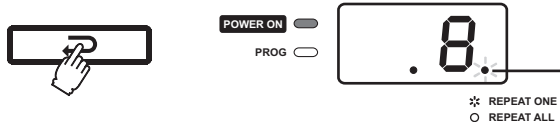

Note: When it flashes, it indicates that the unit is playing a track repeatedly. If it lights up, the unit will play the whole disc repeatedly.

To Repeat the Whole Disc

- Press the **REPEAT** **↻** button twice, the **•** indicator located in the right bottom corner of the screen will light up. The current disc will be played repeatedly starting from the current playing point.

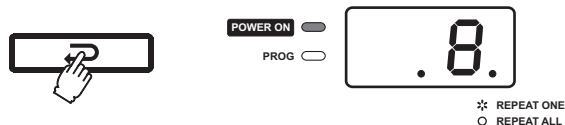

Compact Disc Playback

To Cancel Repeat Play

- Press the **REPEAT** **↻** button until the REPEAT indicator turns off.

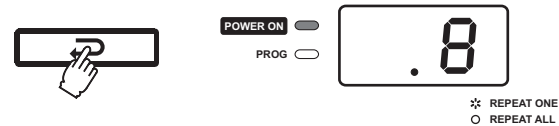

Note:

- CD, CD-R and CD-RW are supported on this unit.
- .mp3 and .WMA files are not compatible with this unit.

PROGRAMMABLE PLAYBACK

20 tracks can be programmed to play in a preset order.

1. When the unit is ON and in CD MODE, make sure the CD is STOPPED. Press the **PROG** button, the screen appears as below:

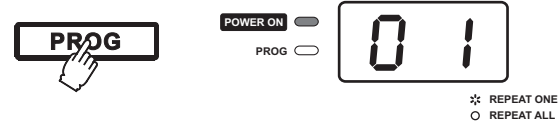

2. Press the **◀◀** / **▶▶** buttons to select the desired track. For example, to play track 3 first, the display will look like this:

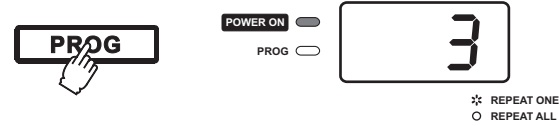

3. Press the **PROG** button to store the track in memory.
 4. To add additional tracks, repeat steps 2 - 3 (up to 20 tracks).
 5. To start playback, press the **PLAY/PAUSE** **▶||** button.

While creating a program track list, the PROG indicator flashes. After setting, it will light up.

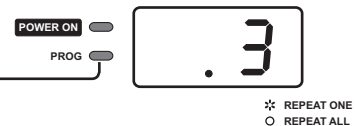

To check the program:

- After setting, the PROG indicator lights up. Press the **PLAY/PAUSE** **▶||** button to start playing, then press the **◀◀** / **▶▶** buttons to check the programmed tracks.

To add additional tracks during program playback:

- Press the **STOP** **■** button, then press the **PROG** button repeatedly until the number of the last programmed track appears and repeat steps 2-4 above.

To change the programmed tracks during program playback:

- Press the **STOP** **■** button, and press the **PROG** button repeatedly to select the number of the program, then press the **◀◀** / **▶▶** buttons to alter the track. Press the **PROG** button to register the newly programmed track into memory.

To erase the whole program, do one of the following:

- Press the **STOP** **■** button twice.
- Switch the FUNCTION selector to radio mode.
- Open the CD drawer by pressing the **▲** button.

Once the whole program list has been erased, the PROG indicator will be OFF.

Note: You can use the REPEAT function during program play.

Connecting with Other External Equipment

Listening to the Audio Signals from the External Equipment

- Connect the AC power cord to the wall outlet.
- Connect the plug of the LINE-IN cable from LINE-IN jack to the AUDIO OUT or Earphone jack of the external equipment.
- Slide the FUNCTION selector to the AUX position.
- Turn on your audio equipment and play the external source.

FOR PERSONAL LISTENING

Connect headphone/earphone (Ø3.5mm stereo mini plug) to the PHONES jack.

When headphones are connected, the speakers are automatically disconnected.

Note: Excessive sound pressure from earphones and headphones can cause hearing loss.

Maintenance

CLEANING THE UNIT

- Do not use volatile chemicals on this unit. Clean by lightly wiping with a dry soft cloth.
- Keep the CD Drawer closed to keep dust out of the unit.

CLEANING THE CD

- If the CD skips or will not play, the disc may need to be cleaned. Before playing, wipe the disc from the center outwards with a clean cloth. After playing, store the disc in its case.

IMPORTANT NOTE

- If an abnormal display indication or an operating problem occurs, disconnect the AC adapter. Wait at least 5 seconds, then reconnect it.
- Before transporting the unit, remove the disc from the disc compartment.

Troubleshooting Guide

SYMPTOM	CAUSE (AND REMEDY)
No sound.	<ul style="list-style-type: none"> Turn VOLUME clockwise. The headphones are connected. Disconnect them.
No sound from one channel or unbalanced left and right volume.	<ul style="list-style-type: none"> Check the speaker connections of the inoperative channel.
Reversed left and right sound.	<ul style="list-style-type: none"> Check the speaker cord connection and speaker location.
Lack of bass sound or imprecise physical location of musical instruments.	<ul style="list-style-type: none"> Check the speaker connection for proper phasing - ensure that the positive terminal from the amplifier is connected to the positive terminal of the speaker.
Severe hum or noise.	<ul style="list-style-type: none"> A TV or VCR is too close to the stereo system. Separate the stereo system from the TV or VCR.
CD	
Disc in place but unit won't play.	<ul style="list-style-type: none"> Make sure the AC power cord is connected to the wall outlet. Make sure FUNCTION selector is set to CD. Make sure disc label is facing up. Make sure disc is clean. Pause mode is activated. Disc may be damaged or dirty; check disc.
Disc skips.	<ul style="list-style-type: none"> Make sure the unit is on a secure spot. Vibration or jarring can cause the disc to skip.
RADIO	
Poor FM reception.	<ul style="list-style-type: none"> Make sure FM antenna wire is unwound. Electrical interference in your home can cause poor reception. Move the unit away from sources of interference (especially those with motors and transformers).
Poor AM reception.	<ul style="list-style-type: none"> Reposition or turn the main unit for better reception.

Limited Warranty

AVC MULTIMEDIA ("AVC") makes the following limited warranties. These limited warranties extend to the original consumer purchaser and is limited to non-commercial user of the product.

One Year Parts & Labor Warranty

AVC products purchased in the United States are warranted to be free from defects in materials or workmanship for a period of one year from the date of their original retail purchase. If the unit fails to conform to this warranty, we will service the product using new or refurbished parts and products, at AVC's sole discretion.

During a period of one year from the effective warranty date, AVC will provide, when needed, service labor to repair a manufacturing defect at its designated Service Center. To obtain warranty service in the United States, you must first call our Customer Support Center at 1-877-252-6873, during the hours listed in the box below. The determination of service will be made by AVC customer support.

PLEASE DO NOT RETURN YOUR UNIT TO AVC WITHOUT PRIOR AUTHORIZATION. New or remanufactured replacements for defective parts or products will be used for repairs by AVC at its designated Service Center for one year from the defective warranty date. Such replacement parts or products are warranted for an additional one year from the date of repair or replacement. The Customer will be required to ship the unit to the Service Center indicated at the time Customer Support is contacted to make the necessary repairs. The customer is responsible for all transportation charges to the service facility.

Packaging and Shipping Instruction

When you send the product to the AVC service facility you must use the original carton box and packing material or an equivalent as designated by AVC.

LIMITED WARRANTY

Your Responsibility

- You must retain your bill of sale to provide proof of purchase.
- These warranties are effective only if the product is purchased and operated in the U.S.A. or Canada.
- Warranties extend only to defects in material or workmanship, and do not extend to any product or parts which have been lost or discarded, or damage to product or parts caused by misuse, accident, improper operation or maintenance, or use in violation of instructions provided with the product, or to product which has been altered or modified without authorization of AVC, or to products or parts thereof which have had the serial number removed or changed.

Out of Warranty

In the event your product requires repair after the limited warranty period has expired, please contact our Customer Support Center at 1-877-252-6873 or www.rcaav.com.

Hours: Monday-Thursday: 9am-7pm, Friday: 9am-5pm, Saturday: 9am-NOON Eastern time.

Important:

You are responsible for any transportation, shipping or insurance relative to the return of the product to our Product Returns Center.

All warranties implied by state law, including the implied warranties of merchantability and fitness for a particular purpose, are expressly limited to the duration of the limited warranties set forth above. With the exception of any warranties implied by state law as hereby limited, the foregoing warranty is exclusive and in lieu of all other warranties, guarantees, agreements and similar obligations of manufacturer or seller with respect to the repair or replacement of any parts. In no event shall AVC be liable for consequential or incidental damages.

No person, agent, distributor, dealer or company is authorized to change, modify or extend the terms of these warranties in any manner whatsoever. The time within action must be commenced to enforce any obligation of AVC arising under the warranty or under any statute, or law of the United States or

any state thereof, is hereby limited to one year from the date of purchase. This limitation does not apply to implied warranties arising under state law.

This warranty gives you specific legal rights and you may also have other rights, which may vary from state to state. Some states do not allow limitation on how long an implied warranty lasts, when an action may be brought, or the exclusion or limitation of incidental or consequential damages, so the above provisions may not apply to you.

For more information on other products and services, please contact our web site at www.rcaav.com.

Important:

Also keep your "Bill of Sale" as proof of purchase.

Model no. Product name
 Type of set Serial no.
 Invoice no. Date purchased
 Dealer name

FOR SERVICE AND REPAIR, PLEASE VISIT www.rcaav.com.

Specifications and external appearance are subject to change without notice.

Free Manuals Download Website

<http://myh66.com>

<http://usermanuals.us>

<http://www.somanuals.com>

<http://www.4manuals.cc>

<http://www.manual-lib.com>

<http://www.404manual.com>

<http://www.luxmanual.com>

<http://aubethermostatmanual.com>

Golf course search by state

<http://golfingnear.com>

Email search by domain

<http://emailbydomain.com>

Auto manuals search

<http://auto.somanuals.com>

TV manuals search

<http://tv.somanuals.com>