

VR730HF

USER'S GUIDE

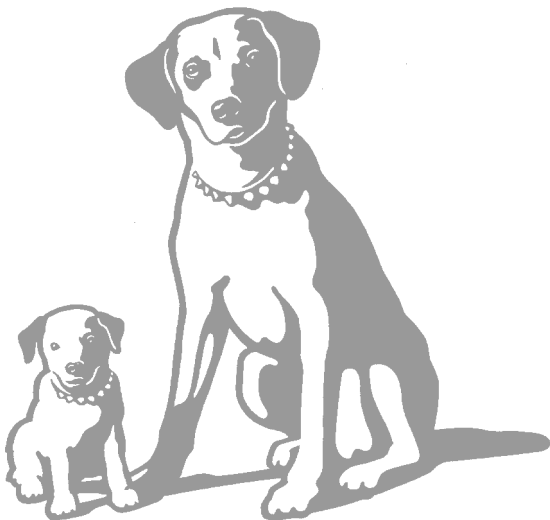

VIDEO CASSETTE **RECORDER**

RECORDER

Important Information

WARNING

To reduce the risk of fire or shock hazard, do not expose this product to rain or moisture.

WARNING

RISK OF ELECTRIC SHOCK
DO NOT OPEN

TO REDUCE THE RISK OF ELECTRIC SHOCK, DO NOT REMOVE COVER (OR BACK). NO USER SERVICEABLE PARTS INSIDE. REFER SERVICING TO QUALIFIED SERVICE PERSONNEL.



This symbol indicates dangerous voltage inside the product that presents a risk of electric shock or personal injury.



This symbol indicates important instructions accompanying the product.

Cautions

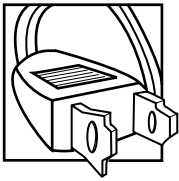

Caution: To prevent electric shock, match wide blade of plug to wide slot, fully insert.

Attention: Pour éviter les chocs électriques, introduire la lame la plus large de la fiche dans la borne correspondante de la prise et pousser jusqu'au fond.

Refer to the identification/rating label on the back of the product for the proper operating voltage .

FCC Regulations state that unauthorized changes or modifications to this equipment may void the user's authority to operate it.

Note To Cable TV Installer

This reminder is provided to call your attention to Article 820-40 of the National Electrical Code (Section 54 of the Canadian Electrical Code, Part 1) which provides guidelines for proper grounding and, in particular, specifies that the cable ground shall be connected to the grounding system of the building as close to the point of cable entry as practical.

Product Registration

Please fill out the product registration card and return it immediately. Returning this card allows us to contact you if needed.

Keep your sales receipt to obtain warranty parts and service and for proof of purchase. Attach it here and record the serial and model numbers in case you need them. The numbers are located on the back of the product.

Model No. **VR730HF** _____

Serial No. _____

Purchase Date: _____

Dealer/Address/Phone: _____

Table of Contents

Important Information

Warnings	i
Cautions	i
Note to Cable TV Installer	i
Product Registration	i

Hooking Up the VCR

Choosing a Hookup	2
Antenna or Cable System Without a Cable Box	3
Cable System With Cable Box to Unscramble All Channels	4
Cable System With Cable Box to Unscramble Only Pay Channels	5
RCA Digital Satellite Receiver	6-7
Connecting Two VCRs for Copying Tapes	8

Setting Up the VCR

Startup	
Check Accessories With VCR	9
Insert Batteries in Remote	9
Turn on the TV	9
Turn on the VCR	10
Set Up Your VCR	10-13
Cable Box Setup	10-11
Digital Satellite System Setup	11
Auto Clock Set	12
Auto Channel Search	13
Add or Remove Channels from VCR's Memory	14
Set the AUTO TV/VCR Feature	14
Use TV•VCR Button	14
Set Display Panel Brightness	15

Using the Remote Control

Remote Control	16-17
Controlling a VCR	18
Controlling a Laserdisc Player or DVD Component	18
Controlling a TV	19
Controlling a Cable Box or Satellite Receiver	20
Controlling an Auxiliary Component	21

Playing a Tape

Playback	22
Using the Playback Features	
Auto Play Feature	23
Picture Search	23
Slow Motion	23
DISPLAY Button	24
Time Counter	24
Pause for Stop-Action	25
Automatic Tracking	25

Manual Tracking	25
Auto Repeat Feature	25
Index Search	26
Zero Search	26
Blank Search	27
TAPE PLAYBACK: HI-FI/MIX/ LINEAR Feature	27
Variable Speed Picture Search Using SHUTTLE DIAL on the VCR	28
Variable Speed Picture Search and Frame Advance Using JOG SHUTTLE on the Remote Control	28

Recording and Playback Feature

COMMERCIAL

Choosing a Hookup

The hookups on pages 3 through 8 are divided into two hookup types: Basic (A) and Advanced (B).

The basic hookup shows the backs of TVs that have only an antenna/cable connection. It is the easier of the two and additional accessories may not be needed.

The advanced hookup shows the VCR hooked up to a TV with audio and video jacks. This connection may improve the picture quality as well as convenience of operation.

Answer the questions to choose the hookup for your VCR.

1. How does your TV receive signals?

Choose one answer from below.

- A. Outside antenna ⌘ Turn to page 3.
- B. Rabbit ears (set-top) and/or bow tie antenna ⌘ Turn to page 3.
- C. Cable System ⌘ Go to question 2.
- D. Digital satellite receiver and another source (A, B, C) ⌘ Go to question 3.

2. What type of Cable-TV system* do you have?

Choose one answer from below.

- A. Cable without a box ⌘ Turn to page 3.
- B. Cable box to unscramble all the channels ⌘ Turn to page 4.
- C. Cable box to unscramble only pay channels, such as HBO, Showtime, Cinemax, etc. ⌘ Turn to page 5.

3. What type of digital satellite receiver do you have?

Choose one answer from below.

- A. Satellite receiver connected to TV without audio/video inputs ⌘ Turn to page 6.
- B. Basic satellite receiver connected to TV with audio/video inputs ⌘ Turn to page 7.
- C. Deluxe satellite receiver connected to TV with audio/video inputs ⌘ Turn to page 7.

Optional Hookups

How to hook up two VCRs for copying tapes?

- A. Select a hookup by answering the questions above.
- B. Then, modify the connections as shown on page 8.

*You may need to contact your local cable company for assistance.

Antenna or Cable System Without a Cable Box

A. Basic hookup.

Use this hookup for a basic connection which requires fewer accessories.

1. Set the **3CH.4** switch on back of VCR to either channel 3 or 4.
Tune the TV to this channel and use the TV•VCR button to watch the VCR.
2. Connect as shown.
This connection may require additional accessories not provided.
3. Plug in power cords of VCR and TV.
4. **Go to 0Startup0 section.**

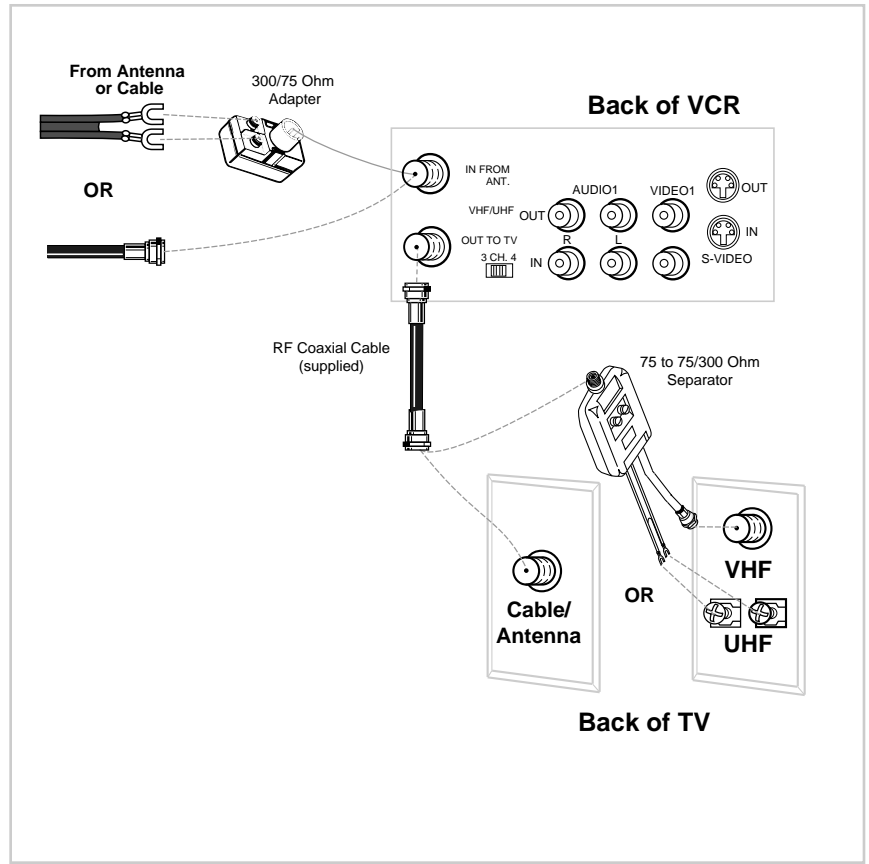

B. Advanced hookup.

Use this hookup for slightly improved picture quality, hi-fi stereo playback, and more convenient operation. Use of the TV•VCR button is not required.

1. Connect as shown.
This connection requires additional accessories not provided. If your TV/monitor has an S-VIDEO connector, also connect the supplied S-VHS cable to take advantage of S-VHS. If your TV is not stereo, you may need a Y-adaptor to hear sound from both channels.
 2. Plug in power cords of VCR and TV.
 3. **Go to 0Startup0 section.**
- Tune the TV to its video input to watch the VCR. Set the AUTO TV/VCR feature to OFF. See the AUTO TV/VCR step in the "Startup" section.

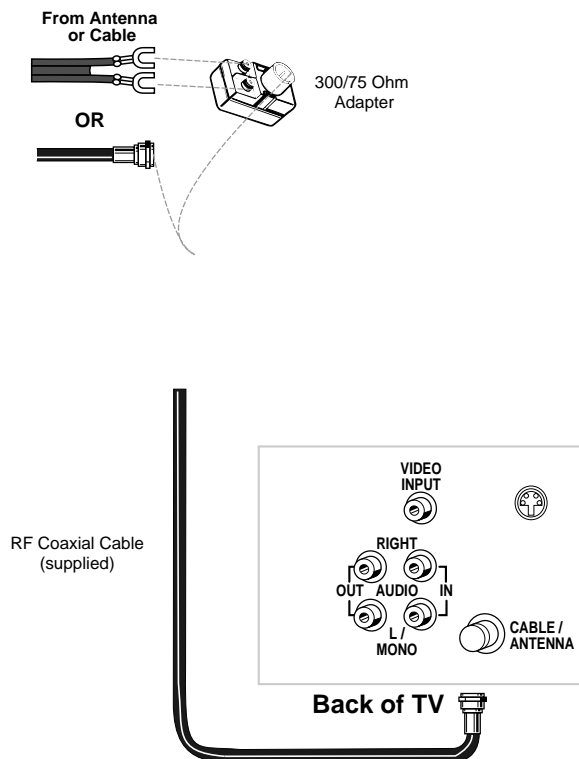

Cable System With Cable Box to Unscramble All Channels

Position Cable Box

Position the remote-controllable cable box on top of the VCR. You may need to position it at different angles before the VCR can control it. Make sure the cable box does not cover the transmitting window on top of the VCR.

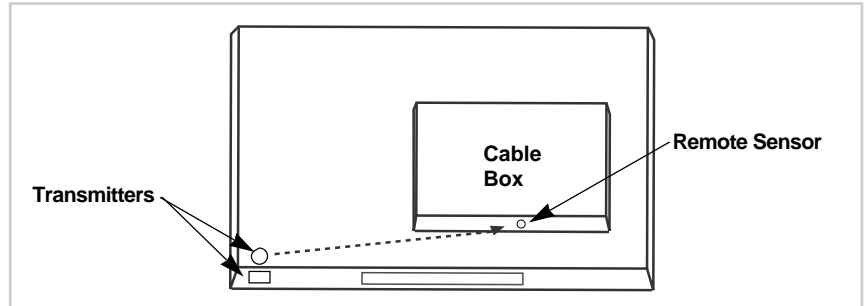

A. Basic hookup.

Use this hookup for a basic connection which requires fewer accessories.

1. Set the **3CH.4** switch on back of VCR to either channel 3 or 4.
Tune the TV to this channel and use the TV•VCR button to watch the VCR.
2. Connect as shown.
This connection may require additional accessories not provided.
3. Plug in power cords of VCR, TV, and cable box .
4. **Go to 0Startup0 section.**

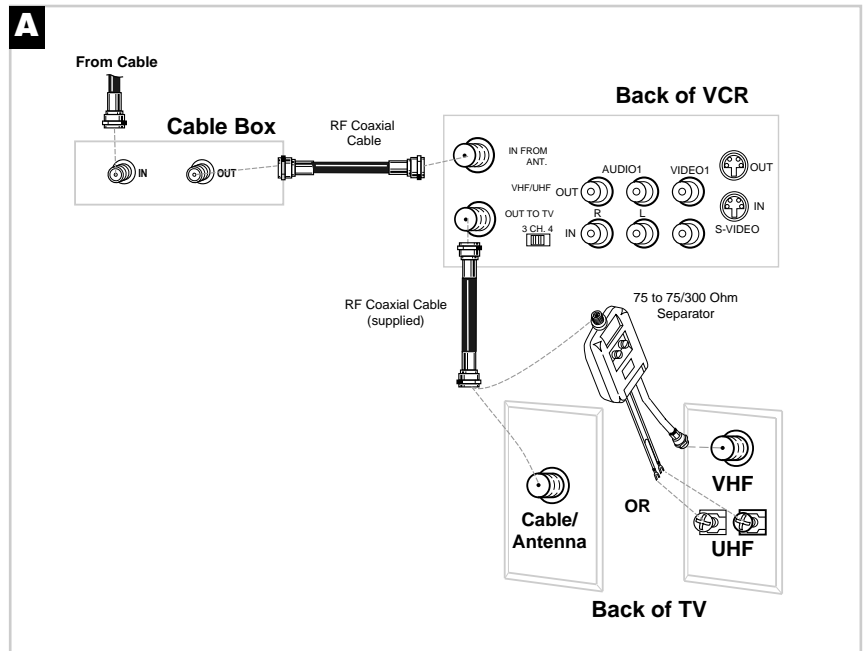

B. Advanced hookup.

Use this hookup for slightly improved picture quality, hi-fi stereo playback, and more convenient operation. Use of the TV•VCR button is not required.

1. Connect as shown.
This connection requires additional accessories not provided.
2. Plug in power cords of VCR, TV, and cable box.
If your TV/monitor has an S-VIDEO connector, also connect the supplied S-VHS cable to take advantage of S-VHS. If your TV is not stereo, you may need a Y-adaptor to hear sound from both channels.
3. **Go to 0Startup0 section.**

Tune the TV to its video input to watch the VCR. Set the AUTO TV/VCR feature to OFF. See the AUTO TV/VCR step in the "Startup" section.

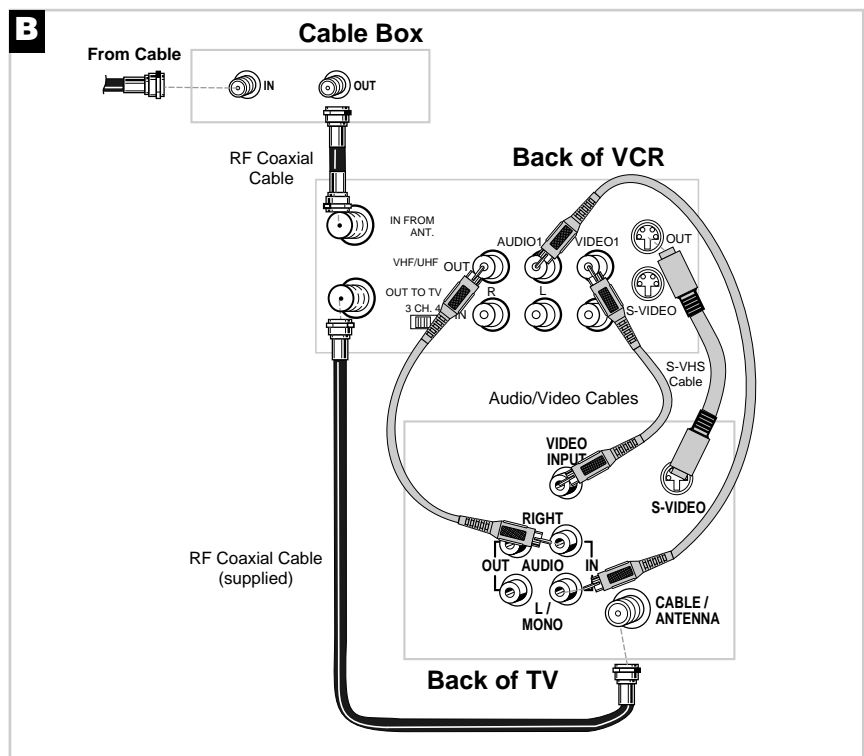

Cable System With Cable Box to Unscramble Only Pay Channels

(such as HBO, Showtime, Pay-Per-View, etc.)

Position Cable Box

Position the remote-controllable cable box on top of the VCR. You may need to position it at different angles before the VCR can control it. Make sure the cable box does not cover the transmitting window on top of the VCR.

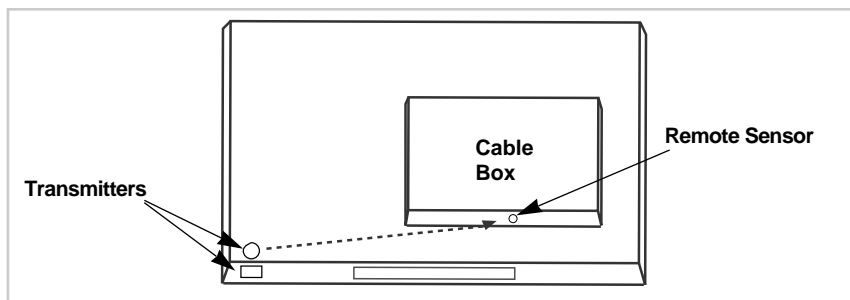

A. Basic hookup.

Use this hookup for a basic connection which requires fewer accessories.

1. Set the 3CH.4 switch on back of VCR to either channel 3 or 4.

Tune the TV to this channel and use the TV•VCR button to watch the VCR.

2. Connect as shown.

This connection may require additional accessories not provided.

3. Plug in power cords of VCR, TV, and cable box.

4. Go to 0Startup0 section.

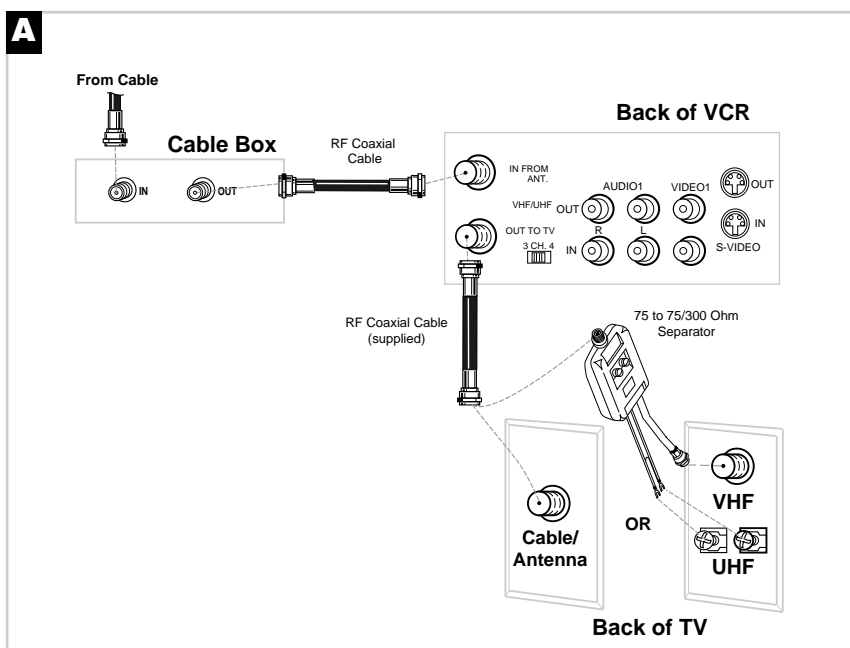

B. Advanced hookup.

Use this hookup for slightly improved picture quality, hi-fi stereo playback, and more convenient operation. Use of the TV•VCR button is not required.

1. Connect as shown.

This connection requires additional accessories not provided. If your TV/monitor has an S-VIDEO connector, also connect the supplied S-VHS cable to take advantage of S-VHS. If your TV is not stereo, you may need a Y-adapter to hear sound from both channels.

2. Plug in power cords of VCR, TV, and cable box.

3. Go to 0Startup0 section.

Tune the TV to its video input to watch the VCR. View all pay channels through the VCR.

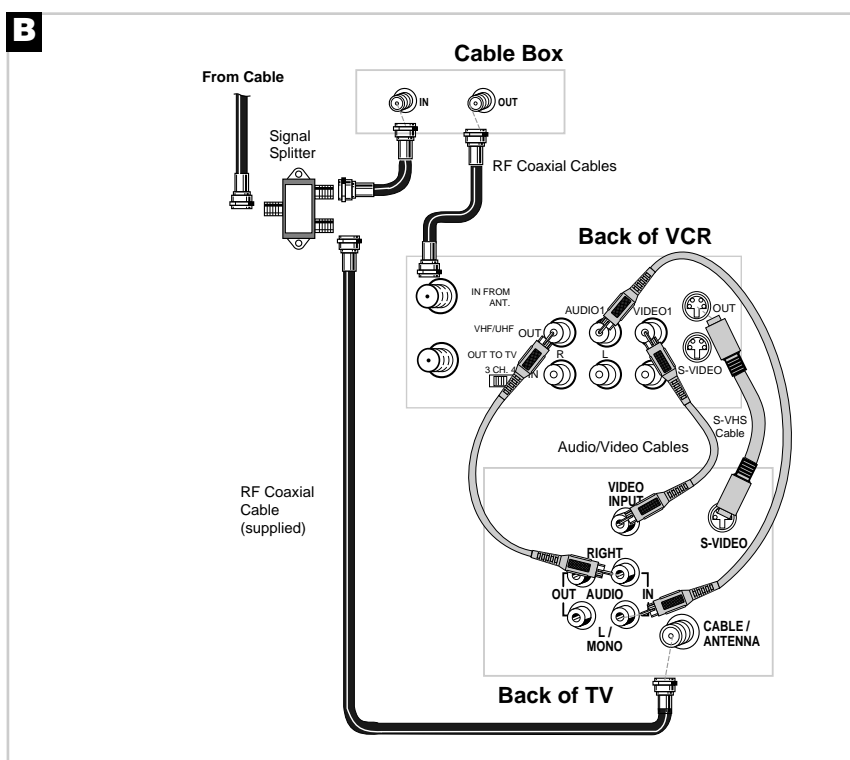

RCA Digital Satellite Receiver

Position the satellite receiver.

Position the receiver on top of the VCR. You may need to position it at different angles before the VCR can control it. Make sure the receiver does not cover the transmitting window on top of the VCR.

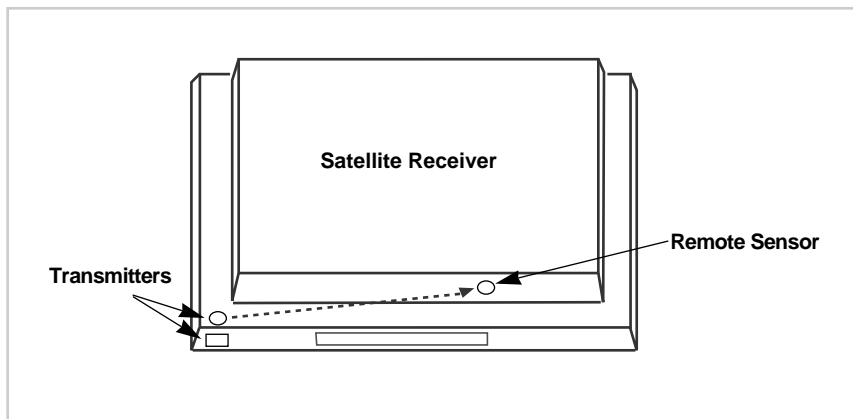

A. Basic hookup.

Use this hookup if your TV does not have audio/video jacks.

1. Set the **CH3 CH4** switch on back of satellite receiver to either channel 3 or 4. You will tune the VCR to this channel or its line input (L1) to record from the satellite receiver. To watch the satellite receiver, turn off the VCR. If you want to watch or record the signal from your antenna, cable, or cable box, make sure the satellite receiver is turned off.
2. Set the **CH3 CH4** switch on back of VCR to either channel 3 or 4. You will tune the TV to this channel and use the **TV•VCR** button to watch the VCR.
3. Connect as shown. This connection may require additional accessories not provided.
4. Plug in power cords of VCR, TV, and receiver.
5. **Go to 0Startup0 section.**

Caution: The unauthorized recording of satellite broadcasts, television programs, or other materials may infringe the rights of others.

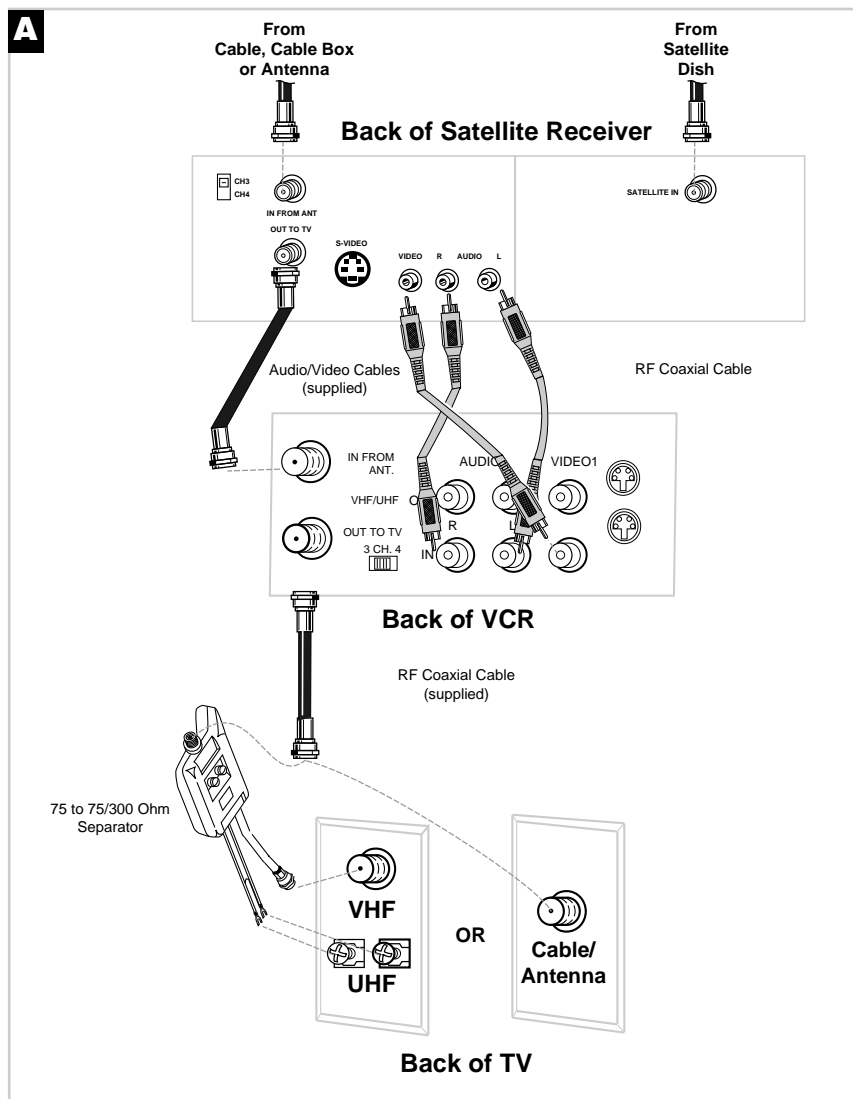

RCA Digital Satellite Receiver

B. Advanced hookup with basic receiver.

Use this hookup if your TV has audio/video jacks and your receiver has one set of AUDIO/VIDEO jacks.

1. Set the **CH3 CH4** switch on back of receiver to either channel 3 or 4.

You will tune the VCR to this channel to record from the satellite receiver. To watch the satellite receiver, tune your TV to its video input channel. If you want to watch or record the signal from your antenna, cable, or cable box, make sure the satellite receiver is turned off.

2. Set the **CH3 CH4** switch on back of VCR to either channel 3 or 4.

You will tune the TV to this channel and use the **TV•VCR** button to watch the VCR.

3. Connect as shown.

This connection may require additional accessories not provided.

4. Plug in power cords of VCR, TV, and receiver.

5. **Go to 0Startup0 section.**



C. Advanced hookup with deluxe receiver.

Use this hookup if your TV has audio/video jacks and your receiver has two sets of AUDIO/VIDEO jacks.

1. Set the **CH3 CH4** switch on back of VCR to either channel 3 or 4.

You will tune the TV to this channel and use the **TV•VCR** button to watch the VCR. To record from the satellite receiver, you will tune the VCR to its line input (L1). To watch the satellite receiver, tune your TV to its video input channel.

2. Connect as shown.

This connection may require additional accessories not provided.

3. Plug in power cords of VCR, TV, and receiver.

4. **Go to 0Startup0 section.**

Connecting Two VCRs for Copying Tapes

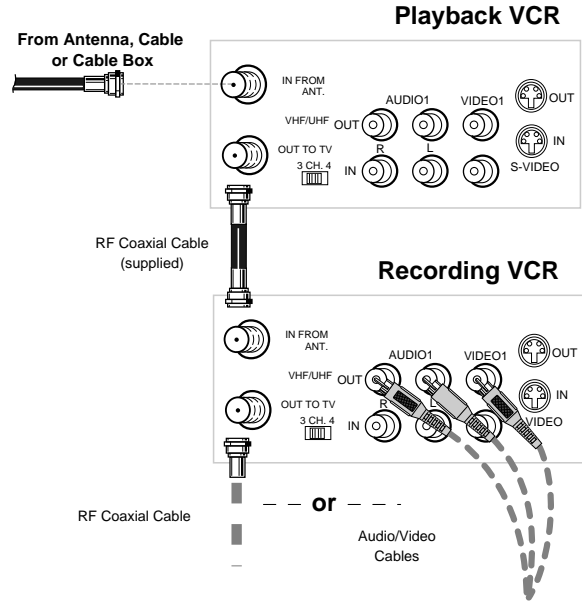

Use the hookup to the TV as previously selected on pages 3, 4, or 5.

Startup

1. Check accessories with VCR.

Contact your dealer if any items are missing.

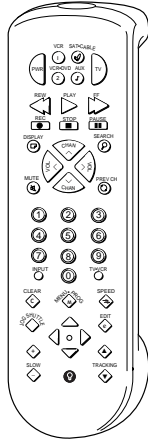

Remote (Stock No. 231546)

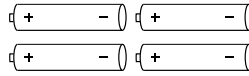

4 "AAA" Batteries

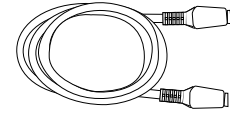

S-VHS Connecting Cable
(Stock No. 219748)

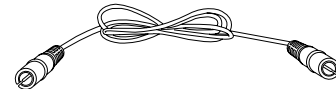

RF Coaxial Cable
(Stock No. 234607)

2. Insert batteries in remote.

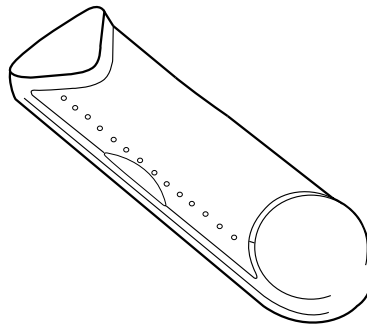

3. Turn on the TV.

- A. Turn on the TV.
- B. If you used one of the basic hookups, tune the TV to the channel selected with the 3 CH. 4 switch on back of VCR.

If you used one of the advanced hookups, tune the TV to the TV's video input.
(See TV owner's manual for details.)

Startup

4. Turn on the VCR.

A. Press VCR1 on the remote.

The **CABLE BOX SETUP** screen appears the *first time* the VCR is turned on after connecting it. A step-by-step procedure is used to set up the VCR for *Cable Box Setup* with cable box control, *DSS Setup*, *Auto Clock Set* using Coordinated Universal Time information transmitted by some broadcast stations, and *Auto Channel Search*. If you choose to set up the VCR options individually, go to the 0Set up your VCR0 step.

If the **CABLE BOX SETUP** screen does not appear:

- ¥ Make sure TV is tuned to same channel as channel 3/4 switch. or TV's video line input.
- ¥ Make sure VCR indicator is on in the VCR display panel if you use a basic hookup.
- ¥ Check the connections.

B. Follow the step-by-step procedures until setup is complete. If setup is successful, skip the next step.

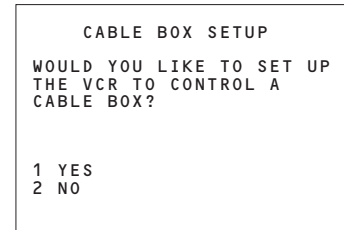

5. Set up your VCR.

The initial **SETUP** is a one-time procedure only; and should you wish to change or reset an individual feature, follow the instructions in this step. Some of the feature options may not apply to your VCR configuration.

Cable Box Setup

This setup applies only when all channels are received through the the cable box. There are two options to this setup. The first option allows you to set up the VCR for the output channel of the cable box signal. The second option, if the cable box has a remote control, lets the VCR know the cable box brand so it can control the cable box by changing channels for timer recordings.

- A. Press **MENU** on the remote to display the **VCR MAIN MENU**.
- B. Press **4** to display the **CHANNELS** menu.
- C. Press **5** to select **CABLE BOX SETUP**.
- D. Select one of the three choices:

1 ALL CHANNELS

1. Press **1** to select **ALL CHANNELS**.
2. Enter two numbers for the output channel of your cable box or press **INPUT** or **00**.
3. Press **MENU** to continue.

2 ONLY SOME CHANNELS

Skip this setup if your cable box is not required for all channels.

3 CANCEL SETUP

Select this item to return to previous screen.

E. Follow the on-screen displays.

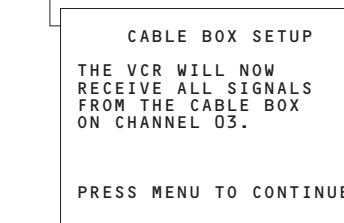
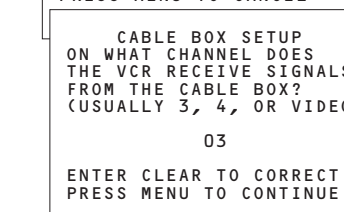
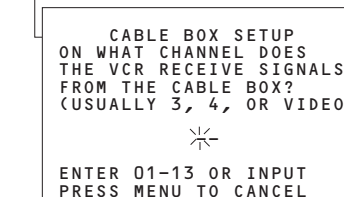
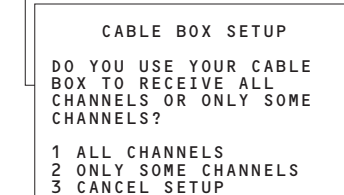
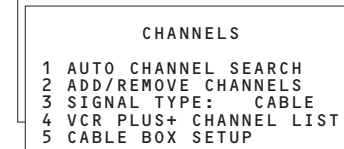
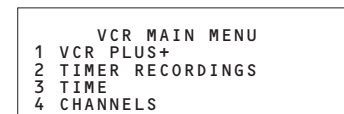

Startup

After the output channel of the cable box signal is set up, the VCR prompts you to set up the cable box brand for cable box control. Just follow the on screen displays.

- A. Turn on your cable box and tune it to channel 2.
- B. Enter the code for your cable box.

Cable Box Code List			
Brand *	Code Number(s)	Brand *	Code Number(s)
ABC	53,54	Pioneer	18,20,44
Anvision	07,08	Randtek	07,08
Cablestar	07,08	RCA	00,27
Eagle	07,08	Regal	12,13
Eastern Int.	02	Regency	02,33
General Instr.	04,05,15,23,24,25,30,36	Samsung	44
Hamlin	12,13,34,48	Scientific Atlanta	03,22,35
Hitachi	37,43	Sylvania	11
Jerrold	04,05,15,23,24,25,30,36,45,46,47	Teknika	06
Macom	37,43	Texscan	10,11
Magnavox	07,08,19,26,28,29,32,33,40,41	Tocom	17,21,49,50
NSC	09	Unika	31,32,41
Oak	01,16,38	Universal	51,52
Oak Sigma	16	Viewstar	07,08,19,26,28,29,32,33,40,41
Panasonic	03,27,39	Warner Amex	44
Philips	07,08,19,26,28,29,32,33,40,41	Zenith	14,42

* The remote may not be able to control every cable box model of the brands listed.

- C. Follow the on-screen displays.

CABLE BOX SETUP

PLEASE TURN ON YOUR CABLE BOX AND TUNE IT TO CHANNEL 2.

CABLE BOX SETUP

ENTER THE CODE FOR YOUR CABLE BOX FROM THE LIST IN YOUR USER'S MANUAL.

✱

CABLE BOX SETUP

ENTER THE CODE FOR YOUR CABLE BOX FROM THE LIST IN YOUR USER'S MANUAL.

06

CABLE BOX SETUP

DID THE CABLE BOX TUNE TO CHANNEL 9?

1 YES, SETUP IS COMPLETE

CABLE BOX SETUP

THE CABLE BOX SETUP IS COMPLETE.

THE VCR WILL CONTROL THE CABLE BOX CHANNEL DURING TIMER RECORDING.

PRESS MENU TO CONTINUE

Digital Satellite System Setup

This section applies only if you have an RCA, ProScan, or GE digital satellite receiver. With this setup, the VCR turns on the satellite receiver and tunes the satellite receiver to the desired channel at the start time of a timer recording.

- A. Press MENU on the remote to display the VCR MAIN MENU.
- B. Press 4 to display the CHANNELS menu.
- C. Press 6 to select DSS SETUP.
- D. Enter the output channel of your satellite receiver. Press 0 before a single-digit number.

If you connected your receiver to the AUDIO/VIDEO OUT jacks, press INPUT on the remote to select the VIDEO option.

- E. Follow the on-screen displays.

VCR MAIN MENU

1 VCR PLUS+
2 TIMER RECORDINGS
3 TIME
4 CHANNELS

CHANNELS

1 AUTO CHANNEL SEARCH
2 ADD/REMOVE CHANNELS
3 SIGNAL TYPE: CABLE
4 VCR PLUS+ CHANNEL LIST
5 CABLE BOX SETUP
6 DSS SETUP

DSS SETUP

ON WHAT CHANNEL DOES THE VCR RECEIVE SIGNALS FROM THE DSS RECEIVER?

✱

DSS SETUP

ON WHAT CHANNEL DOES THE VCR RECEIVE SIGNALS FROM THE DSS RECEIVER?

04

DSS SETUP

THE VCR WILL NOW RECEIVE ALL SIGNALS FROM THE DSS RECEIVER ON CHANNEL 04.

DSS SETUP

DID THE DSS RECEIVER TURN ON AND TUNE TO CHANNEL 200?

1 YES, SETUP IS COMPLETE
2 NO, TRY AGAIN
3 NO, CANCEL SETUP

Startup

AUTO CLOCK SET

The AUTO CLOCK SET feature is set to ON at the factory. With this feature on, the VCR automatically updates the clock using the Coordinated Universal Time information transmitted by some broadcast stations. The TIME ZONE and DAYLIGHT SAVINGS TIME menu items must be set for your area. With this feature off, the clock will not be set or updated automatically.

- A. Press MENU on the remote to display the VCR MAIN MENU.
- B. Press 3 to display the TIME menu.
- C. Press 2 to switch AUTO CLOCK SET between ON and OFF.

Set the Time Zone

1. Press MENU on the remote to display the VCR MAIN MENU.
2. Press 3 to display the TIME menu.
3. Press 3 to display the SET THE TIME ZONE menu.
4. Select your time zone.

¥ If you select AUTOMATIC for your time zone, the VCR sets the clock using the first Coordinated Universal Time information it finds. If the time is not correct, select another time zone or use the SET TIME AND DATE option.

Set Daylight Savings Time

1. Press MENU on the remote to display the VCR MAIN MENU.
2. Press 3 to display the TIME menu.
3. Press 4 to display the SET DAYLIGHT SAVINGS menu.
4. Select one of the options.

¥ If you select YES, DST IS OBSERVED:

In the Spring, daylight-saving time begins on the first Sunday in April. Because the clock automatically changes from 2:00 AM to 3:00 AM (forward one hour), remember that any part of a scheduled Timer Recording that falls between these two times will not be recorded.

In the autumn, daylight-saving time ends on the last Sunday in October. The VCR clock automatically changes from 2:00 AM to 1:00 AM (back one hour). Therefore, it can affect your recording length.

¥ If you select AUTOMATIC, the VCR sets the clock using the first Coordinated Universal Time information it finds.

Notes: With a cable box, the VCR will not reset the clock after a power outage unless the cable box is set to the channel carrying the broadcast signal.

If AUTO CLOCK SET is unsuccessful, try tuning the VCR (or cable box) to a channel carrying the XDS information (usually PBS), then turn the VCR off. If the time does not set within 10 minutes, set the time and date manually through the menu items.

Check local cable system or TV stations for availability of channels with Extended Data Service (XDS).

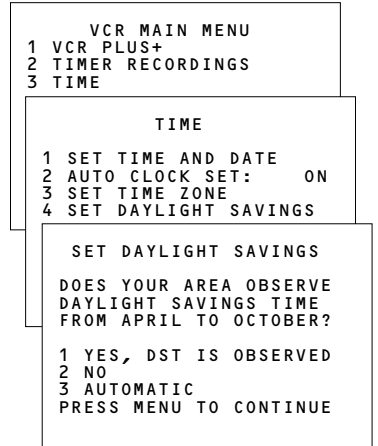
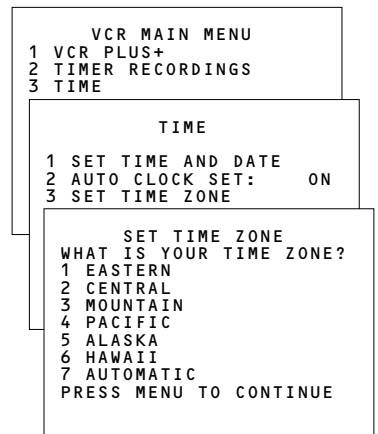
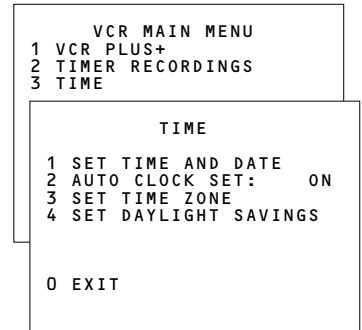

Startup

Set the Clock

If the AUTO CLOCK SET was unsuccessful, set the clock through the menu option. Also, if you choose to set the clock manually, the AUTO CLOCK SET feature is automatically turned off.

- A. Press MENU on the remote to display the VCR MAIN MENU.
- B. Press 3 to display the TIME menu.
- C. Press 1 to display the SET TIME AND DATE.
- D. Use the number buttons on the remote to enter the time including AM or PM, month, day, and year. The day of the week will automatically appear after you enter the year.
 - ¥ Press 0 before single-digit numbers. Press 1 for AM or 2 for PM. Example: press 0, then 5, then 0, then 7, then 2 for a time of 5:07 PM.
 - ¥ Press CLEAR on the remote at any time to change incorrect entries.
- E. Press MENU to set the clock.
- F. Press 0 to exit the menus.

The time appears in the VCR's display panel. To display the time and date on the screen, press DISPLAY on the remote.

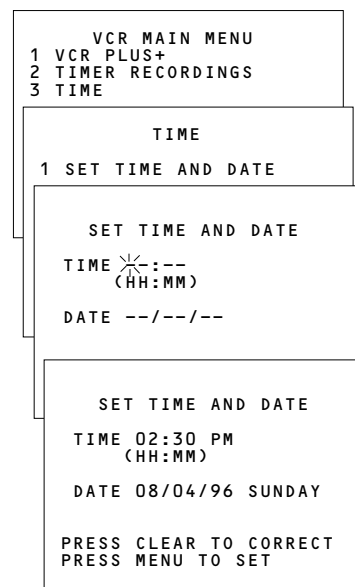

Auto Channel Search

The AUTO CHANNEL SEARCH feature memorizes the channel list available through your signal system (cable or antenna). The signal system is automatically selected when you auto channel search. Should you change your signal system, you must perform Auto Channel Search again.

Wait until the channel numbers stop changing. This takes about one to two minutes. The TV tunes to the lowest channel found. Pressing CHANNEL up or down selects only the active channels.

- A. Press MENU on the remote to display the VCR MAIN MENU.
- B. Press 4 to display the CHANNELS menu.
- C. Press 1 to begin AUTO CHANNEL SEARCH.

The VCR automatically selects the CABLE (cable TV) or ANTENNA signal. For cable connection, 125 channels are searched; for an antenna connection, 69 channels are searched.

To change the SIGNAL TYPE:

- A. Follow steps A-B above.
- B. Press 3 to switch the SIGNAL TYPE between CABLE and ANTENNA.

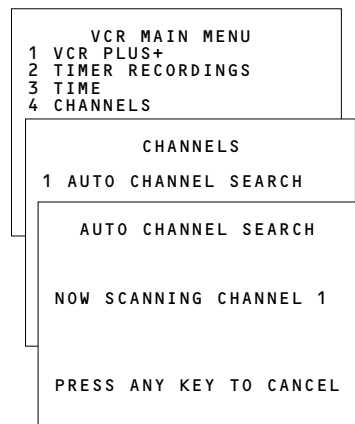

Startup

6. Add or remove channels from the VCR's memory.

You may want to add or remove channels if some of the channels are not active, have weak signals, or you do not want to watch them.

We recommend channels be placed in memory using the AUTO CHANNEL SEARCH feature before adding or removing channels.

- A. Press MENU on the remote to display the VCR MAIN MENU.
- B. Press 4 to display CHANNELS menu.
- C. Press 2 to display ADD/REMOVE CHANNEL screen.
- D. Use CHANNEL up and down or the number buttons to go to channels you want to add or delete.
- E. Follow the on-screen directions.

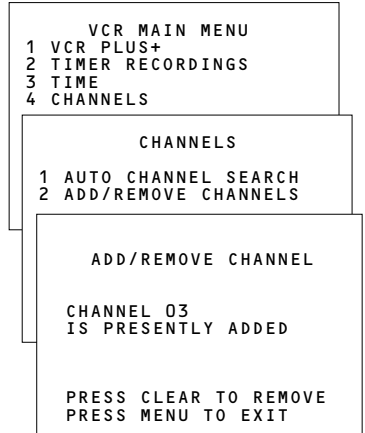

7. Set AUTO TV/VCR feature.

Skip this step if you used one of the basic hookups.

If you connected your VCR using the video input of your TV, you can prevent the VCR indicator from turning on automatically.

- A. Press MENU on the remote to see VCR MAIN MENU.
- B. Press 5 to display the PREFERENCES menu.
- C. Press 3 to select AUTO TV/VCR: ON or OFF.
 - ¥ Select ON if you are using one of the basic hookups and watch your VCR on channel 3 or 4 of your TV. Then, you can press the TV•VCR button to switch between the picture coming from the VCR (the VCR indicator is on) or television channels (the VCR indicator is off).
 - ¥ Select OFF if you are using one of the advance hookups and watch your VCR on the video input channel of your TV. The VCR indicator will not turn on automatically.

Pressing TV•VCR still turns the VCR indicator on or off.

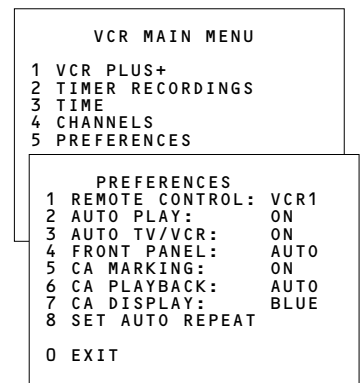

8. Use TV•VCR button.

Skip this step if you used one of the advanced hookups.

When using one of the basic hookups, the TV•VCR button lets you switch between the picture coming from the VCR or television channels. This button lets you record a program on the VCR while watching another channel on the TV. *Details are in the 0Recording0 section.*

- A. Press VCR1 to set the remote to control the VCR.
- B. Press TV•VCR to see the picture from the VCR. The VCR indicator lights in the display panel.
- C. Press CHANNEL up or down to change channels on the VCR. The channel number followed by the station name (if broadcast) appears for a few seconds on the TV screen.
- D. Press TV•VCR to see the TV channels. The VCR indicator does not light in the display panel. Change channels using the TV's remote.
- E. Return the TV to the VCR viewing channel Ñ CH3 or CH4.
- F. Press VCR, then TV•VCR to switch back to the picture from the VCR.

Startup

9. Set the display panel brightness.

This VCR lets you change the brightness level of the fluorescent display panel.

- A. Press MENU on remote to see the VCR MAIN MENU.
- B. Press 5 to display the PREFERENCES menu.
- C. Press 4 to select a FRONT PANEL mode.
 - ¥ Select AUTO to keep the display panel bright when VCR is on and dim when it is off.
 - ¥ Select BRIGHT to keep the display panel bright.
 - ¥ Select DIM to keep the display panel dim.

```
VCR MAIN MENU
1 VCR PLUS+
2 TIMER RECORDINGS
3 TIME
4 CHANNELS
5 PREFERENCES

PREFERENCES
1 REMOTE CONTROL: VCR1
2 AUTO PLAY: ON
3 AUTO TV/VCR: ON
4 FRONT PANEL: AUTO
5 CA MARKING: ON
6 CA PLAYBACK: AUTO
7 CA DISPLAY: BLUE
8 SET AUTO REPEAT
0 EXIT
```

Remote Control

Your back-lit remote has a light button  that glows in the dark. Pressing this button lights the buttons on the remote. The remote buttons remain lit when they are pressed within a few seconds of each other. If a button is not pressed within approximately eight seconds, the light turns off to conserve battery power.

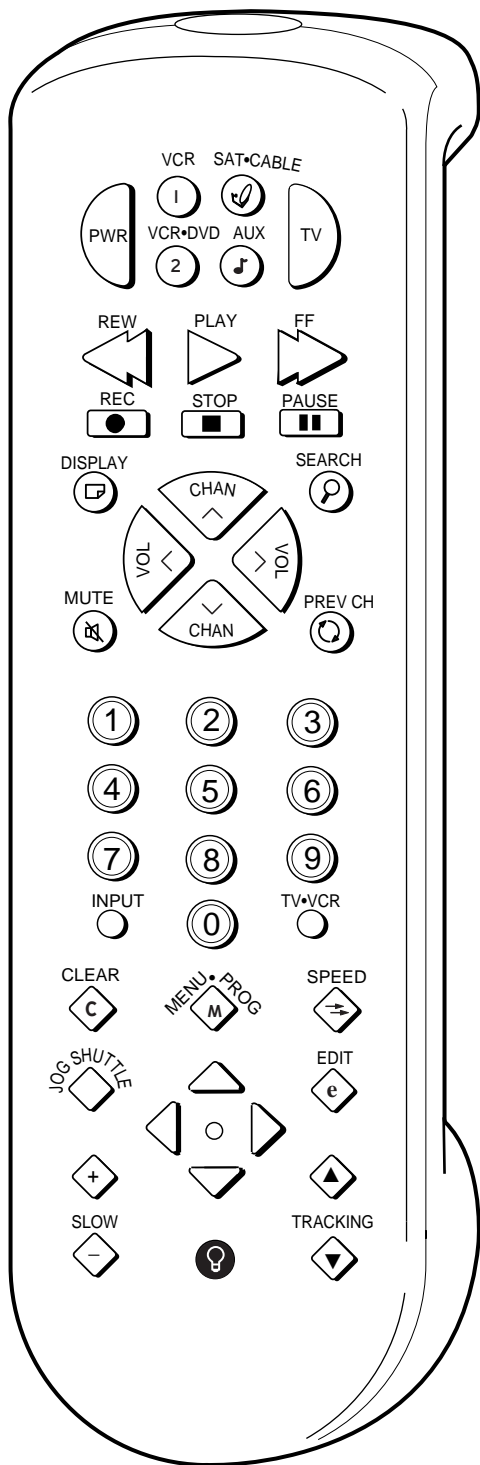

Component Buttons

Press one of the buttons to set the remote to operate that component.

AUX (Auxiliary)

Can be programmed to control a compatible RCA audio or RCA, ProScan, or GE video component. See the *Controlling an Auxiliary Component* section.

SAT+CABLE

Turns on a compatible cable box or satellite receiver.

Used with PWR button to turn on another brand of cable box or receiver when the remote is programmed to control that cable box or receiver. See the *Controlling a Cable Box or Satellite Receiver* section.

TV

Turns on a compatible RCA, ProScan, or GE TV and sets the remote to control the TV.

Used with PWR button to turn on another brand of TV when the

remote is programmed to control that TV. See the *Controlling a TV* section.

VCR1

Turns on a compatible RCA, ProScan, or GE VCR and sets remote to control VCR.

VCR2+DVD

Turns on a compatible RCA, ProScan, or GE VCR and sets remote to control VCR when it has been setup. See the *Controlling a Laserdisc Player or DVD Component* section.

Used with PWR button to turn on compatible RCA or ProScan Laserdisc player.

Can also be programmed to control a compatible RCA DVD component.

 Used to light the remote buttons.

VCR Function Buttons

Press VCR1 (VCR2+DVD) to set the remote to control the VCR and use the function buttons.

CHAN (Channel) Up or Down

Selects next higher or lower channel in the VCR's channel memory.

CLEAR

Resets time counter to 0:00:00.

Lets you change entries when setting the clock or VCR for a VCR Plus+ or timer recording.

DISPLAY

Displays VCR operating displays on the TV screen.

Displays the time counter.

EDIT

Signals two properly connected compatible VCRs to begin copying a tape. See the *Using Dual Remote with AutoEdit* section.

FF (Fast Forward)

Fast forwards the tape when the VCR is stopped.

Searches the picture in forward motion during playback.

INPUT

Turns the line input (L1 or L2) on or off.

Line input refers to the signal coming from the component connected to the audio/video jacks on the back (L1) or the front (L2) of the VCR.

JOG SHUTTLE and

Used for frame advance.

Used for variable speed search.

The indicator in the center of the arrow buttons lights when the jog shuttle is turned on.

MENU+PROG

Displays the VCR MAIN MENU on the TV screen.

Used for VCR Plus+ and Timer Recordings.

VCR Function Buttons (continued)

Numbers (0 through 9)

Select a channel up to 99↵press two numbers.

Select a cable channel over 99↵press and hold 1 until 1-- appears on the screen. Then, press the other two numbers.

PAUSE

Pauses action for viewing during playback.

Pauses recording to prevent recording of unwanted scenes.

PLAY

Plays a tape.

PWR (Power)

Turns off VCR when remote is set to control the VCR.

Press twice to turn off all compatible RCA components.

CHAN (Channel) Up or Down

Selects next higher or lower channel in the TV's channel memory when remote is set to control a TV.

CLEAR

Removes menus or status displays from the screen.

DISPLAY

Shows the status displays on the screen.

Removes menus or displays from the screen.

MENU•PROG

Selects the TV's main menu.

MUTE

Turns the TV sound on or off.

PREV CH (Previous Channel)

Switches between two channels.

Select one channel and then select another. Press PREV CH to switch between the two channels.

REC (Record)

Starts the VCR recording.

Used for express recording.

REW (Rewind)

Rewinds the tape when the VCR is stopped.

Searches a tape in reverse motion during playback.

SEARCH

Displays the INDEX, ZERO, and BLANK search menus on the TV.

Used during playback with the COMMERCIAL▶ADVANCE^a feature.

MOVE Arrow Buttons

Allow you to move through the menus, enter data, and change settings of selected features.

Numbers (0 through 9)

Selects a channel up to 99↵press two numbers.

Selects a cable channel over 99↵press and hold 1 until 1-- appears on the screen. Then, press the other two numbers.

PWR (Power)

Turns off a compatible TV when remote is set to control that TV.

SLOW +/-

Used for slow-motion playback.

SPEED (Tape Speed)

Selects a recording speed (SP or SLP).

STOP

Stops the VCR's normal functions such as record, playback, rewind, fast forward, and pause.

TRACKING Up or Down

Reduces the streaks that may appear on the picture during play, slow, or pause.

Reduces picture "jitter" during stop-action playback.

TV•VCR

Switches the picture signal so that it either comes from the VCR or the TV channel. See "Startup" section.

Used with the TV button to turn on a compatible TV that the remote has been programmed to control.

Controlling a VCR

The VCR's remote control is programmed for compatible RCA, ProScan, or GE VCRs with the VCR1 and VCR2•DVD buttons. Most compatible VCRs automatically respond to VCR1 without being programmed. If you own two compatible VCRs, test them to see if VCR1 turns on both VCRs. If it does, then you may want to program this VCR to respond to the VCR2•DVD button on the remote.

Program the VCR for Remote Control

Set the REMOTE CONTROL feature of the VCR to the VCR1 or VCR2•DVD position. Then, the remote controls the VCR with either the VCR1 or VCR2•DVD button $\bar{\text{N}}$ the position you select in the menu.

1. Press MENU to display the VCR MAIN MENU.
2. Press 5 to display the PREFERENCES menu.
3. Press 1 to activate the REMOTE CONTROL feature.
4. Press VCR1 or VCR2•DVD to change the setting and program this VCR to respond to the VCR1 or VCR2•DVD button $\bar{\text{N}}$ the position you select.

Important Reminder: Remember you must press VCR1 or VCR2•DVD on the remote $\bar{\text{N}}$ the position you selected in the menu $\bar{\text{N}}$ before the remote will operate this VCR.

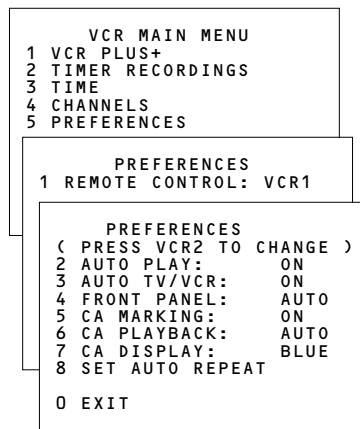

Controlling a Laserdisc Player or DVD Component

The VCR2•DVD button on the VCR's remote is programmed to control most RCA and ProScan laserdisc players or RCA, ProScan, and GE VCRs. It can also be programmed to control an RCA DVD component using the code below. If the remote is changed for the DVD component, remember to reprogram with the codes below to operate a VCR or laserdisc player.

Program the Remote Control

1. Turn on the component.
2. Point the VCR remote at the component.
3. Hold the VCR2•DVD button and press three number buttons to enter the code for the component.
4. Release the buttons.
5. Press PWR or CHANNEL up or down. If the component turns off or changes channels, setup is complete.

RCA, ProScan or GE Codes		
VCR	Laserdisc Player	DVD
037	037	078

Operate the Component

After you set up your remote to control your component, test the remote buttons to see which ones operate the component.

1. Point the VCR remote at the component and press VCR2•DVD.
2. If the component does not turn on in step 1, press VCR2•DVD and then PWR.

Controlling a TV

The VCR's remote is programmed to control the basic functions of compatible RCA, ProScan, and GE TVs. Also, you can set up the remote to control other manufacturer's brands. To program the remote, enter the remote code numbers that correspond to your brand.

Program the Remote for a TV

1. Turn on the TV.
2. Point the VCR remote at the TV.
3. Hold the TV button and press three number buttons to enter the code for your brand.
4. Release the buttons.
5. Press PWR or CHANNEL up or down. If the TV turns off or changes channels, setup is complete.
6. Repeat steps 2 – 5 with a different code if the first one does not work.

TV Codes

Brand*	Code	Brand*	Code	Brand*	Code	Brand*	Code
A-Mark	.102	GE	.000,008,009,011,012,027,	Multivision	.081	Sharp	.011,020,025,027,037
Admiral	.005		.038,068,086,089,091	NAD	.018,023		.052,053,059,060,108
Amtron	.064	Goldstar	.003,004,006,011,019,	NEC	.011,014,019,027,038,084	Signature	.005,094
Akai	.002,103		.027,037,050	Panasonic	.012,013,038,086,111	Sony	.002
Anam	.104,105	Hallmark	.011,027	Penney	.000,008,011,019,027,040,	Soundesign	.011,027,033
Anam National	.038,106	Hitachi	.009,011,027,036,037,040,		.068,077,086,088	Sylvania	.006,007,010,011,013,016,
AOC	.011,019,027,088,107		.047,048,063,080,094,097,098	Philco	.006,007,010,011,013,016,019,		.027,033,035,043,049,066,087,089
Bell&Howell	.005	Infinity	.013		.027,033,035,037,038,043,087,089	Symphonic	.064,076
Candle	.011,027,033	JBL	.013	Philips	.002,006,007,010,011,013,016,	Tatung	.038
Citizen	.011,027,033,064	Jensen	.011,027		.033,035,037,038,043,066,073	Technics	.012
Colortyme	.011,027,084	JVC	.012,024,036,037,040,048,051,074	Pioneer	.011,027,045,062,093	Techwood	.011,027
Concerto	.011,027	Kawasho	.002,011,027	Portland	.011,019,027,037	Teknika	.011,019,027,033,036
Contec/Cony	.036,037,040,042,064	Kenwood	.006,011,014,027	ProScan	.000		.037,040,066
Craig	.064	Kloss Novabeam	.035,043	Proton	.011,027,037,072	Telecaption	.090
Curtis Mathes	.000,011,015,027,037	KTV	.078	Quasar	.012,038,092	TMK	.011,027
CXC	.064	Loewe	.013	Radio Shack	.000,021,025,036,037,	Toshiba	.018,021,023,040,071,
Daewoo	.011,019,027,012	Luxman	.011,027		.059,064,078		.077,085,090
Daytron	.011,027	LXI	.000,013,018,021,023,054	RCA	.000,006,011,019,027,034,	Universal	.008,009
Dimensia	.000	Magnavox	.006,007,010,011,013,016,		.038,044,046,088,100,101,109	Victor	.051
Electrohome	.006,011,014,027,038,		.027,033,035,043,049,066,087,089	Realistic	.021	Vidtech	.019,027
	.061,068	Marantz	.011,013,027,069	Sampo	.011,027	Wards	.000,005,006,007,008
Emerson	.011,026,027,028,029,030,	Memorex	.005	Samsung	.006,011,014,015,019		.009,010,011,013,019,025,027,028,
	.031,032,037,042,053,064,065,067,	MGA	.006,011,014,019,022,		.027,036,037,077,110		.035,043,059,066,076,082,089
	.075,076,078,079,094,095,096		.027,041,056,061,068	Sanyo	.017,021,039,056,057,058	Yamaha	.006,014,019,027
Envision	.011,027	Mitsubishi	.006,011,014,019,022,	Scott	.028,037,064	Zenith	.001,099
Fisher	.017,021,039,041		.027,041,055,056,061,068	Sears	.000,006,011,014,017,018,021,		
Funai	.064	MTC	.011,019,027		.023,027,039,040,041,051,071,083,095		

*The remote may not be able to control every model TV of the brands listed.

Operate the TV

After you set up your remote to control your TV, test the TV buttons to see which ones operate your TV.

1. Point the remote at the TV and press TV.
2. If the TV does not turn on in step 1, press TV, then PWR.
3. Use the TV Function Buttons described in Remote Control section.

Helpful Hint: Notice the difference between the TV and VCR on-screen displays. This is one way to tell if the remote is set to control the VCR or the TV.

Controlling a Cable Box or Satellite Receiver

The SAT•CABLE button on the VCR's remote is programmed to control a compatible RCA cable box or compatible RCA, ProScan, or GE satellite receivers. If your cable box or satellite receiver is another manufacturer's brand and has its own remote, you may be able to program the VCR's remote to control the it. To program the VCR's remote, enter the code that corresponds to your brand.

Program the Remote for a Cable Box or Satellite Receiver

1. Turn on the cable box or satellite receiver.
2. Point the VCR remote at the cable box or satellite receiver.
3. Hold the SAT•CABLE button and press three number buttons to enter the code for your brand.
4. Release the buttons.
5. Press PWR on the remote. If the cable box or satellite receiver turns off, setup is complete.
6. Repeat steps 2 – 5 with a different code if the first one does not work.

Cable Box Codes					
Brand*	Code	Brand*	Code	Brand*	Code
ABC	.022,046,053,054	Magnavox	.007,008,019,021,026, .028,029,032,033,040,041	Signature	.046
Anvision	.007,008	NSC	.009	Sprucer	.027
Cablestar	.007,008	Oak	.001,016,038	Starcom	.046
Diamond	.056	Oak Sigma	.016	Stargate 2000	.058
Eagle	.007,008	Panasonic	.003,027,039,061	Sylvania	.011,059
Eastern Int.	.002	Philips	.007,008,019,021,026,028, .029,032,033,040,041	Teknika	.006
General Instruments	.046	Pioneer	.018,020,044	Texscan	.010,011,059
GI 400	.004,005,015,023,024, .025,030,036	RCA	.000,027	Tocom	.017,021,049,050,055
Hamlin	.003,012,013,034,048	Randtek	.007,008	Unika	.031,032,041
Hitachi	.037,043,046	Regal	.003,012,013	Universal	.051,052,060
Jerrold	.004,005,015,023,024, .025,030,036, 045,046,047,062,065	Regency	.002,033	Viewstar	.007,008,019,021,026,028 .029,032,033,040,041
Macom	.037,043	Samsung	.044	Warner Amex	.044
		Sci. Atlanta	.003,022,035,063,064	Zenith	.014,042,057,061

Satellite Receiver Codes					
Brand*	Code	Brand*	Code	Brand*	Code
Chaparral	.080,081	RCA	.000	STS3	.087
Cheyenne	.081	Realistic	.084	STS4	.088
Drake	.082,083	Sierra I,0II,0III	.081	Toshiba	.089
GE	.000	STS1	.085	Uniden	.090
General Instruments	.092,093,094	STS2	.086	Video Cipher II	.091
ProScan	.000				

* The remote may not be able to control every cable box or satellite receiver of the brands listed.

Operate the Cable Box or Satellite Receiver

After you set up your remote to control the cable box or satellite receiver, test the buttons to see which ones operate it.

1. Point the remote at the component and press SAT•CABLE.
2. If the component does not turn on in step 1, press SAT•CABLE, then PWR.
3. Use the Cable Box or Satellite Receiver Function Buttons described in the Remote Control section.

Controlling an Auxiliary Component

The remote that came packed with your VCR is also capable of controlling one compatible RCA auxiliary component, such as an AM/FM radio, CD player, tape players, phonograph, satellite receiver, or DVD. The remote must be programmed for the specific component it is to control. To program the remote, use the code that corresponds to your component.

Program the Remote for an Auxiliary Component

1. Turn on the component.
2. Point the VCR remote at the component.
3. Hold the AUX button and press three number buttons to enter the code for your component.
4. Release the buttons.
5. Press PWR on the remote. If the component turns off, setup is complete.

Type of Auxiliary Equipment and Code								
RCA*	AM/FM	AUX	Phono	Cassette Tape 1	CD	DSS	Cassette Tape 2	DVD
	003	004	005	006	007	008	009	010

*The remote may not be able to control every RCA model of auxiliary type listed.

Operate the Auxiliary Component

After you have set up your remote to control your component, test the buttons to see which ones operate the component.

1. Point the remote at the component and press AUX.
2. If the component does not turn on in step 1, press AUX and then PWR.
3. Refer to the *Remote Control* section.

Playback

To play a tape

1. Turn on the TV and tune it to channel 3, 4, or the TV's video input to see the picture from the VCR.
2. Insert a tape in the VCR.
VCR automatically turns on. The cassette-in indicator () lights, and the VCR indicator lights if the AUTO TV/VCR feature is set to ON. The tape automatically begins playback if the safety tab on the cassette has been removed and the AUTO PLAY feature is turned on.

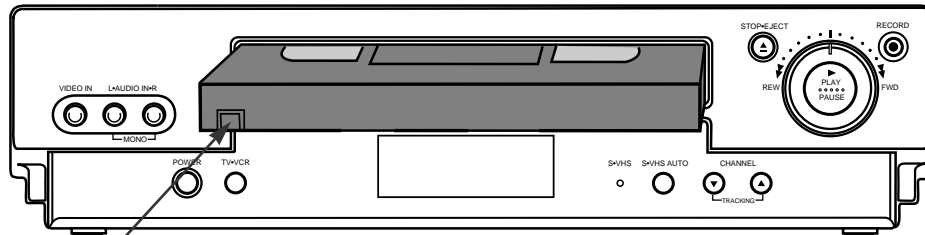

Safety Tab

3. Press PLAY•PAUSE on the VCR or PLAY on the remote or VCR, if necessary.
4. Press TRACKING up or down on the remote or the VCR to remove any streaks from the picture if necessary. See "Manual Tracking" section.
5. Press STOP•EJECT on the VCR or STOP on the remote to stop the tape.
6. Press REW on the VCR or the remote to rewind the tape.

End of Tape

The VCR automatically rewinds the tape if it reaches the end of the tape during playback.

Power Off

If you press POWER while a tape is rewinding, the VCR turns off automatically when it is completely rewound.

6. Press STOP•EJECT on the VCR to eject the tape once it is completely rewound.

Using the Playback Features

AUTO PLAY Feature

This feature allows the VCR to automatically start playing when you insert a tape with the safety tab removed.

1. Press MENU on the remote to display the VCR MAIN MENU.
2. Press 5 to display the PREFERENCES menu.
3. Press 2 to select AUTO PLAY: ON or OFF.
 - ¥ Select ON if you want to have a tape with its safety tab removed to start playing automatically.
 - ¥ Select OFF if you *do not* want a tape with its safety tab removed to start playing automatically.

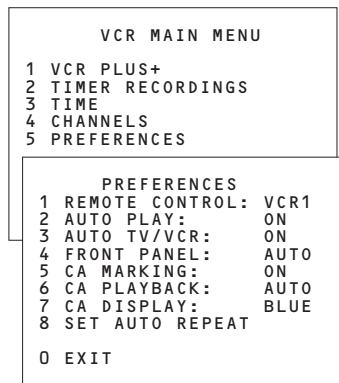

Picture Search

You can search for a specific tape location during playback by fast forwarding or rewinding the tape. Sound is turned off during picture search. Picture search works best for tapes recorded in the SP or SLP speed.

Fast Forward Search

1. Press FF on the remote or use the SHUTTLE DIAL on the VCR to search forward at a faster-than-normal speed.
2. Press FF or PLAY on the remote or use the SHUTTLE DIAL or PLAY•PAUSE on the VCR to return to playback.

Rewind Search

1. Press REW on VCR or remote to search backward at a faster-than-normal speed.
2. Press REW or PLAY on the remote or use the SHUTTLE DIAL or PLAY•PAUSE on the VCR to return to playback.

Slow Motion

You can view a tape in slow motion during play or play pause. The SLOW + and – buttons let you vary the speed. Sound is turned off during slow-motion playback. Slow motion works best for tapes recorded in the SP or SLP speed.

1. Press SLOW + or – during playback to begin slow motion.
2. Press SLOW + to increase the speed or SLOW – to decrease the speed.
3. Use TRACKING up or down to remove any streaks from the picture.
4. Press PLAY on the remote or PLAY•PAUSE on the VCR to return to playback.

The VCR automatically switches from slow-motion playback to stop after a few minutes.

Using the Playback Features

DISPLAY Button

The DISPLAY button shows the status of the VCR channel number, station ID (if broadcast), time counter, date, time and tape speed on the TV screen. The time and date must be set before they can be displayed.

1. Press DISPLAY.
If you do not press DISPLAY again, this display times out.
2. Press DISPLAY again to display only the time counter on the TV screen.
Time counter also appears in the VCR panel.
3. Press DISPLAY again to remove displays from the screen.
Time counter remains displayed in the VCR panel.
4. Press DISPLAY again to return to original display.
Time counter is removed from VCR front panel and display times out.
Turning off the VCR automatically returns the displays to normal.

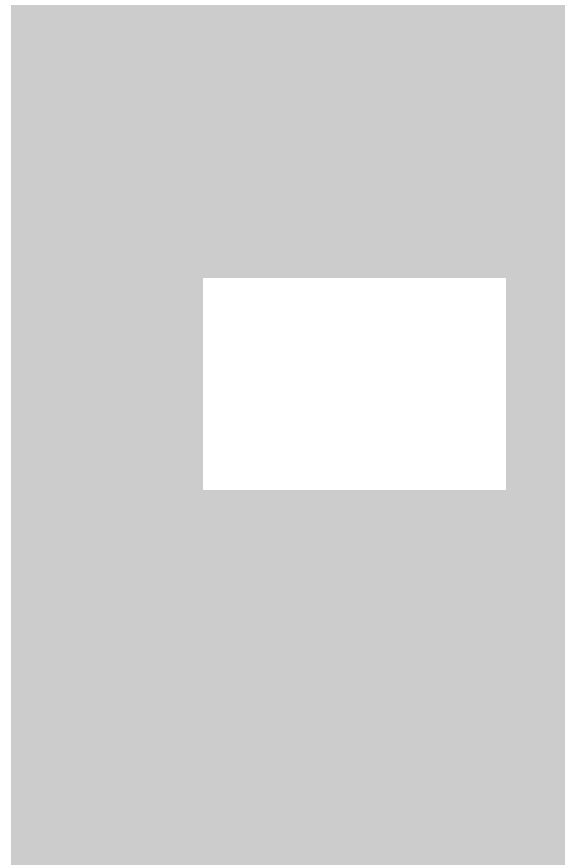

Time Counter

The time counter shows the actual time it takes to record a program or play back a segment of a prerecorded tape. It helps locate the beginning or ending of programs you taped. The time counter resets to 0:00:00 when the tape is ejected from the VCR.

For example, if you record a 30-minute program at the beginning of the tape and you want to go to the end of that program to begin another recording, you would:

1. Insert the prerecorded tape and make sure it is rewound to the beginning.
2. Press DISPLAY twice to display only the time counter on the TV screen.
3. Press CLEAR to reset the time counter to 0:00:00.
4. Press FF on the remote or use the SHUTTLE DIAL to fast forward the tape until 0:30:00 appears in the time counter and press STOP.
The time counter does not advance when it detects no signal (blank tape).
5. Press DISPLAY to remove the time counter from the screen.

Using the Playback Features

Pause for Stop Action

This feature stops the tape in action and lets you examine the details of the scene. Stop action works best for tapes recorded in the SP or SLP speed.

1. Press PAUSE on the remote or PLAY•PAUSE on the VCR during playback to stop the action.
 2. Press TRACKING up or down to move the lines out of the picture or reduce any jittering of the picture.
 3. Press PAUSE or PLAY on the remote or PLAY•PAUSE on the VCR to return to playback.
- The VCR automatically switches from stop-action playback to stop after a few minutes.

Automatic Tracking

The VCR has automatic tracking which adjusts the picture when you are playing back a tape recorded on another VCR. Automatic tracking is turned on when a tape is inserted or the VCR's power is turned on.

Manual Tracking

Occasionally, you may need to manually adjust tracking on a tape recorded on a different VCR or camcorder. Tracking is used when playing a tape, and it has no effect during recording.

- ¥ When streaks or snow appear in the picture, press TRACKING up or down on the remote or the VCR for the best possible picture.
- ¥ During pause, press TRACKING up or down on the remote to reduce any jittering of the picture.
- ¥ To turn Automatic Tracking back on, press both TRACKING buttons on the front of the VCR at the same time, or eject the tape and re-insert it.

AUTO REPEAT Feature

When you set this feature, the VCR plays a tape for the amount of time you specify, over and over. For example, if you enter a length of two hours, the VCR will play the tape for two hours, automatically rewind the tape, and play the tape again.

1. Press MENU on the remote to display the VCR MAIN MENU
2. Press 5 to display the PREFERENCES menu.
3. Press 8 to display the SET AUTO REPEAT menu.
4. Set the length of time you want the tape to play in a repeating loop with the number buttons.
 - ¥ Use the number buttons to enter the length of time.
 - ¥ Select a length of 0:00 with the CLEAR button if you do not want the tape to repeat.
 - ¥ Eject the tape to cancel the repeat feature.
 - ¥ If the time you enter exceeds the actual length of the tape, the VCR plays to the end of the tape.

```

VCR MAIN MENU
1 VCR PLUS+
2 TIMER RECORDINGS
3 TIME
4 CHANNELS
5 PREFERENCES
    
```

```

PREFERENCES
1 REMOTE CONTROL: VCR1
2 AUTO PLAY: ON
3 AUTO TV/VCR: ON
4 FRONT PANEL: AUTO
5 CA MARKING: ON
6 CA PLAYBACK: AUTO
7 CA DISPLAY: BLUE
8 SET AUTO REPEAT
0 EXIT
    
```

```

AUTO REPEAT MENU
SET THE LENGTH OF TIME
YOU WANT THE TAPE TO
PLAY IN A REPEATING LOOP
LOOP FROM 0:00 TO 1:--
(H>MM)
PRESS MENU TO EXIT
    
```

Using the Playback Features

Index Search

The VCR has a 0VHS Index Search System⁰ that automatically records an index mark on the tape every time you begin recording a program. Your VCR has two index playback features. To locate the program you want to play, select a specific index number or search by scanning.

Some index marks may be missed by the VCR.

- ¥ A mark too close to the current location on the tape.
- ¥ The mark at the beginning of a recorded segment of five minutes or less.
- ¥ The first index mark on the tape when you start searching from the beginning of the tape.

To Index Search

1. Insert the prerecorded tape and press **STOP**.
2. Press **SEARCH** on the remote to display the **INDEX SEARCH** menu on the TV screen.
3. Press **REW** or **FF** on the remote or use the **SHUTTLE DIAL** on the VCR to scan. Or, enter the number of index marks you want the VCR to search.
Press **CLEAR** on the remote to correct an entry.
Once the index mark or marks are found, the tape begins playback.
4. Follow the directions on the screen.

```

INDEX SEARCH
PRESS REW OR FF
TO BEGIN SCANNING
OR
ENTER A SPECIFIC
INDEX NUMBER
↑
↓
PRESS SEARCH TO EXIT
    
```

```

INDEX SEARCH
SEARCHING FOR
INDEX MARKS...

PRESS STOP TO CANCEL
    
```

Zero Search

The zero search feature allows the VCR to quickly return to a counter reading of 0:00:00 anywhere on the tape. This is especially convenient when you want to watch a segment of the tape several times.

1. Insert the prerecorded tape.
2. Press **DISPLAY** *twice* to display only the time counter on the TV screen.
3. Use **PLAY**, **FF**, or **REW** to advance to the place on the tape where you want to return quickly.
4. Press **CLEAR** to reset the time counter to 0:00:00.
5. Continue playing the tape.
6. Press **STOP**.
7. Press **SEARCH** *twice* to display the **ZERO SEARCH** menu on the TV screen.
8. Follow the directions on the screen.

```

ZERO SEARCH

CURRENT TAPE COUNTER IS
2:17:25

PRESS REW TO GO TO
0:00:00

PRESS SEARCH TO EXIT
    
```

OR

```

ZERO SEARCH

CURRENT TAPE COUNTER IS
-2:17:25

PRESS FF TO GO TO
0:00:00

PRESS SEARCH TO EXIT
    
```

Using the Playback Features

Blank Search

The VCR searches for blank portions of the tape that are more than six seconds long.

1. Insert the prerecorded tape and press STOP.
2. Press SEARCH *three times* to display the BLANK SEARCH menu.
3. Press FF on the remote or use the SHUTTLE Dial on the VCR to begin searching for six seconds of blank tape. A message appears on the screen if a blank area is not found.
4. Press STOP to stop BLANK SEARCH.

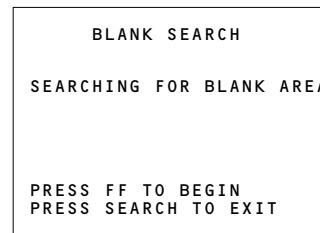

TAPE PLAYBACK: HI-FI/MIX/LINEAR Feature

The VCR records the same audio on both the Hi-Fi and linear tracks on the tape. The Hi-Fi sound is recorded on separate left and right stereo channels. Monaural sound is recorded on the linear track.

To enjoy Hi-Fi sound, connect your VCR to a stereo television or amplifier/receiver using the audio/video jacks. The TAPE PLAYBACK: HI-FI/MIX/LINEAR feature lets you select which audio you play back.

To Select Playback Sound

1. Press MENU to display the VCR MAIN MENU.
2. Press 6 to display the AUDIO menu.
3. Press 2 to switch between HI-FI, MIX, or LINEAR sound.
 - ¥ Select HI-FI to play back sound recorded on the Hi-Fi track and for normal use.
The Hi-Fi indicator lights in the VCR's display panel.
 - ¥ Select MIX to play back the sound recorded on both the linear track and the Hi-Fi track, sound-on-sound.
The Hi-Fi indicator lights in the VCR's display panel.
 - ¥ Select LINEAR to play back the sound recorded on the linear monaural track, such as a second audio program (SAP).
The Hi-Fi indicator turns off in the VCR's display panel.

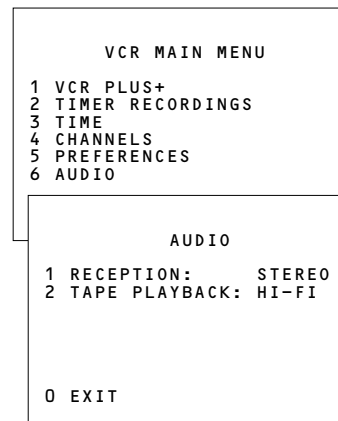

Using the Playback Features

Variable Speed Picture Search Using the SHUTTLE DIAL on the VCR

The SHUTTLE DIAL on the VCR lets you search a picture during playback at variable speeds in both forward and reverse. Sound is turned off during picture search. The picture is best for tapes recorded in the SP or SLP speed.

1. Turn the SHUTTLE DIAL on the VCR while in Play or Still mode to start a forward or reverse search.
 - The more you turn the dial, the faster the search speed.
 - When the SHUTTLE DIAL on the VCR is turned more than half way in stop mode, normal Fast Forward or Rewind begins.
 - Some noise bars are normal during shuttle operation.
 - After 3 minutes in Still or Slow, the VCR will go into Stop mode.
 - When the SHUTTLE DIAL is released, the VCR goes into Still mode.
2. Press PLAY•PAUSE on the VCR, or PLAY or PAUSE on the remote to return to normal playback and turn off the shuttle feature.

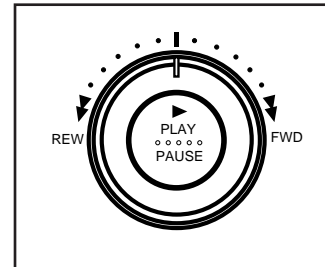

Variable Speed Picture Search and Frame Advance Using JOG SHUTTLE on the Remote Control

During playback, the JOG SHUTTLE button and the left (◀) or right (▶) arrow let you search a tape at variable speeds in both forward and reverse. The JOG SHUTTLE button and the up (▲) or down (▼) arrow let you view one stop-action frame after another.

Sound is turned off during picture search and frame advance. The picture is best for tapes recorded in the SP or SLP speed.

1. Press JOG SHUTTLE on the remote during playback. The indicator in the center of the arrows lights, and the VCR enters pause.
 - Press and quickly release ▶ on the remote to search forward slowly. Press and hold ▶ to search faster.
 - Press and quickly release ◀ on the remote to search in reverse slowly. Press and hold ◀ to search faster.
 - Press ▲ or ▼ on the remote while VCR is searching to place the VCR in pause. Press ▲ to advance or ▼ to reverse the picture one frame at a time.
2. Press PLAY•PAUSE on the VCR, or PLAY or PAUSE on the remote to return to normal playback and turn off the jog shuttle feature.

Pressing a button other than a JOG SHUTTLE button, except TRACKING UP or TRACKING DOWN, turns off the jog shuttle and indicator.

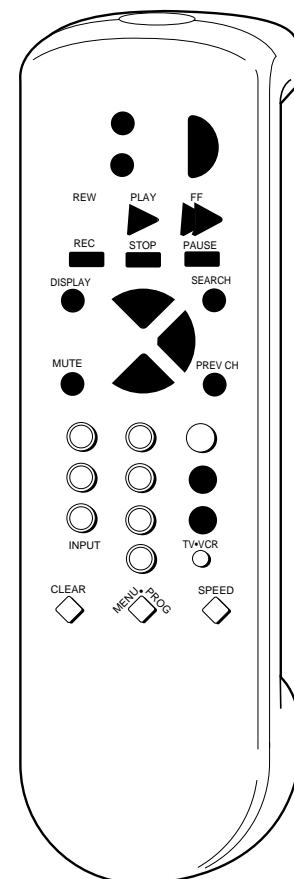

COMMERCIAL▶▶ADVANCE™

COMMERCIAL▶▶ADVANCE^a is a patented technology that detects and marks most commercials on your tape for any recording that is more than 15 minutes long. During playback, the VCR automatically skips the detected commercial segments or you can choose to manually skip them. This feature reduces three minutes of commercials into approximately 8-12 seconds of fast forwarding in the SLP speed. You can select a background of blue or see the video as the commercials are skipped.

After recording, the VCR rewinds the tape to the beginning of the recording and determines where the commercials are located. It then marks the beginning and end of the detected commercial segments and returns the tape to the end of the recording. *It does not erase the commercials from the tape.*

Because television signals do not indicate where commercials are located, this feature finds and marks them through a set of formulas based on how television is broadcast today. Since television stations broadcast differently and insert their own commercials, you may experience some variations in this feature's effectiveness. Station promotions, identifications, and announcements are not considered commercials but might be skipped.

See *òTrouble Checksó* section for answers to common questions about COMMERCIAL▶▶ADVANCE^a.

COMMERCIAL▶▶ADVANCE™ Marking

1. Press MENU to display the VCR MAIN MENU.
2. Press 5 to display the PREFERENCES menu.
3. Make sure CA MARKING is set to ON. If not, press 5.

The VCR will mark most commercials for the following types of recording:

¥ **VCR Plus+, Timer, or One Touch Recording:** The VCR will automatically mark the commercials after the power is turned off.

¥ **Manual Recording:** When you press STOP to stop recording, the VCR will ask you if you want to mark the commercials. Just follow the on-screen display.

MARK and COMM alternate in the display panel while the VCR is marking commercials.

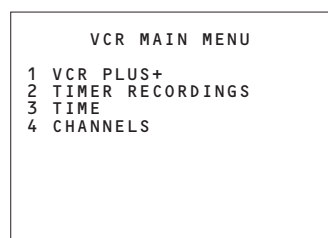

To Stop COMMERCIAL▶▶ADVANCE™ Marking

Press STOP to cancel commercial marking.

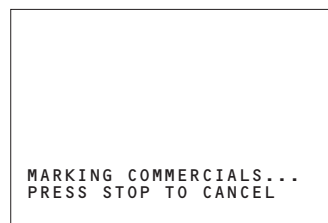

To Turn Off Marking

For special VCR use (such as editing or copying) or if you decide not to use this feature, turn COMMERCIAL▶▶ADVANCE^a marking (CA MARKING) off.

1. Press MENU to display the VCR MAIN MENU.
2. Press 5 to display the PREFERENCES menu.
3. Press 5 to select CA MARKING: OFF.

The VCR will not mark the commercials.

COMMERCIAL▶▶ADVANCE^a is a trademark of Arthur D. Little Enterprises, Inc.
A Jerry Iggulden invention licensed by Arthur D. Little Enterprises, Inc.

COMMERCIAL▶▶ADVANCE™

To Select a Background for Playback

1. Press MENU to display the VCR MAIN MENU.
2. Press 5 to display the PREFERENCES menu.
3. Press 7 to select CA DISPLAY: BLUE or VIDEO.
 - ¥ Select BLUE to have the VCR display a blue screen while it advances through the block of marked commercials.
 - ¥ Select VIDEO to have the VCR display the video as it advances through the block of marked commercials.

```

VCR MAIN MENU
1 VCR PLUS+
2 TIMER RECORDINGS
3 TIME
4 CHANNELS
5 PREFERENCES

PREFERENCES
1 REMOTE CONTROL: VCR1
2 AUTO PLAY: ON
3 AUTO TV/VCR: ON
4 FRONT PANEL: AUTO
5 CA MARKING: ON
6 CA PLAYBACK: AUTO
7 CA DISPLAY: BLUE
8 SET AUTO REPEAT

0 EXIT
    
```

To Play Back a Recording Made Using COMMERCIAL▶▶ADVANCE™

1. Press MENU to display the VCR MAIN MENU.
2. Press 5 to display the PREFERENCES menu.
3. Press 6 to select CA PLAYBACK: AUTO or MANUAL.
 - ¥ Select AUTO to have the VCR automatically advance through the blocks of marked commercials.

It works with most 30, 45, and 60-second commercials.

A commercial group starting within the first two minutes or last two minutes of a recording will not be automatically skipped.

A commercial will not be skipped if the recording starts in the middle of a commercial segment, one isolated commercial is shown without others, or a commercial is longer than one minute. Press FF to scan through the commercial.

It is possible that part of a recorded program might be skipped if the program segment is between commercials and less than one minute or there are frequent dark and quiet scenes. If part of the program is skipped, rewind the tape to the beginning of the skipped program segment and press PLAY.

- ¥ Select MANUAL and the VCR will not advance through the blocks of marked commercials until you press SEARCH.

The VCR will resume playback when it reaches the end of the marked commercials.

If you press SEARCH during playback of material other than commercials, the VCR will still advance to the end of the next 0marked0 commercial block and resume playback.

```

VCR MAIN MENU
1 VCR PLUS+
2 TIMER RECORDINGS
3 TIME
4 CHANNELS
5 PREFERENCES

PREFERENCES
1 REMOTE CONTROL: VCR1
2 AUTO PLAY: ON
3 AUTO TV/VCR: ON
4 FRONT PANEL: AUTO
5 CA MARKING: ON
6 CA PLAYBACK: AUTO
7 CA DISPLAY: BLUE
8 SET AUTO REPEAT

0 EXIT
    
```

COMMERCIAL▶▶ADVANCE™

COMMERCIAL▶▶ADVANCE^a is a patented technology that detects and marks most commercials on your tape for any recording that is more than 15 minutes long. During playback, the VCR automatically skips the detected commercial segments or you can choose to manually skip them. This feature reduces three minutes of commercials into approximately 8-12 seconds of fast forwarding in the SLP speed. You can select a background of blue or see the video as the commercials are skipped.

After recording, the VCR rewinds the tape to the beginning of the recording and determines where the commercials are located. It then marks the beginning and end of the detected commercial segments and returns the tape to the end of the recording. *It does not erase the commercials from the tape.*

Because television signals do not indicate where commercials are located, this feature finds and marks them through a set of formulas based on how television is broadcast today. Since television stations broadcast differently and insert their own commercials, you may experience some variations in this feature's effectiveness. Station promotions, identifications, and announcements are not considered commercials but might be skipped.

See *òTrouble Checksó* section for answers to common questions about COMMERCIAL▶▶ADVANCE^a.

COMMERCIAL▶▶ADVANCE™ Marking

1. Press MENU to display the VCR MAIN MENU.
2. Press 5 to display the PREFERENCES menu.
3. Make sure CA MARKING is set to ON. If not, press 5.

The VCR will mark most commercials for the following types of recording:

¥ **VCR Plus+, Timer, or One Touch Recording:** The VCR will automatically mark the commercials after the power is turned off.

¥ **Manual Recording:** When you press STOP to stop recording, the VCR will ask you if you want to mark the commercials. Just follow the on-screen display.

MARK and COMM alternate in the display panel while the VCR is marking commercials.

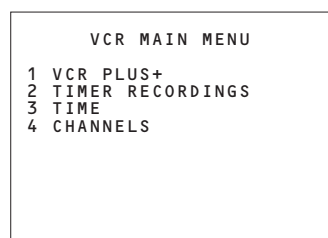

To Stop COMMERCIAL▶▶ADVANCE™ Marking

Press STOP to cancel commercial marking.

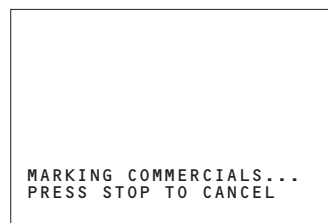

To Turn Off Marking

For special VCR use (such as editing or copying) or if you decide not to use this feature, turn COMMERCIAL▶▶ADVANCE^a marking (CA MARKING) off.

1. Press MENU to display the VCR MAIN MENU.
2. Press 5 to display the PREFERENCES menu.
3. Press 5 to select CA MARKING: OFF.

The VCR will not mark the commercials.

COMMERCIAL▶▶ADVANCE^a is a trademark of Arthur D. Little Enterprises, Inc.
A Jerry Iggulden invention licensed by Arthur D. Little Enterprises, Inc.

COMMERCIAL▶▶ADVANCE™

To Select a Background for Playback

1. Press MENU to display the VCR MAIN MENU.
2. Press 5 to display the PREFERENCES menu.
3. Press 7 to select CA DISPLAY: BLUE or VIDEO.
 - ¥ Select BLUE to have the VCR display a blue screen while it advances through the block of marked commercials.
 - ¥ Select VIDEO to have the VCR display the video as it advances through the block of marked commercials.

```

VCR MAIN MENU
1 VCR PLUS+
2 TIMER RECORDINGS
3 TIME
4 CHANNELS
5 PREFERENCES

PREFERENCES
1 REMOTE CONTROL: VCR1
2 AUTO PLAY: ON
3 AUTO TV/VCR: ON
4 FRONT PANEL: AUTO
5 CA MARKING: ON
6 CA PLAYBACK: AUTO
7 CA DISPLAY: BLUE
8 SET AUTO REPEAT

0 EXIT
    
```

To Play Back a Recording Made Using COMMERCIAL▶▶ADVANCE™

1. Press MENU to display the VCR MAIN MENU.
2. Press 5 to display the PREFERENCES menu.
3. Press 6 to select CA PLAYBACK: AUTO or MANUAL.
 - ¥ Select AUTO to have the VCR automatically advance through the blocks of marked commercials.

It works with most 30, 45, and 60-second commercials.

A commercial group starting within the first two minutes or last two minutes of a recording will not be automatically skipped.

A commercial will not be skipped if the recording starts in the middle of a commercial segment, one isolated commercial is shown without others, or a commercial is longer than one minute. Press FF to scan through the commercial.

It is possible that part of a recorded program might be skipped if the program segment is between commercials and less than one minute or there are frequent dark and quiet scenes. If part of the program is skipped, rewind the tape to the beginning of the skipped program segment and press PLAY.

- ¥ Select MANUAL and the VCR will not advance through the blocks of marked commercials until you press SEARCH.

The VCR will resume playback when it reaches the end of the marked commercials.

If you press SEARCH during playback of material other than commercials, the VCR will still advance to the end of the next 0marked0 commercial block and resume playback.

```

VCR MAIN MENU
1 VCR PLUS+
2 TIMER RECORDINGS
3 TIME
4 CHANNELS
5 PREFERENCES

PREFERENCES
1 REMOTE CONTROL: VCR1
2 AUTO PLAY: ON
3 AUTO TV/VCR: ON
4 FRONT PANEL: AUTO
5 CA MARKING: ON
6 CA PLAYBACK: AUTO
7 CA DISPLAY: BLUE
8 SET AUTO REPEAT

0 EXIT
    
```

Recordings

Your VCR provides different recording options. These options are explained in this section of the manual.

Recording Speeds

Press **SPEED** on the remote to select a recording speed (SP or SLP). The speed you select appears on the TV screen. Tapes recorded in LP can be played in this VCR.

SP (Standard Play) gives the best quality recording. That is why most prerecorded, rental tapes are recorded in SP. Fewer programs can be recorded on the tape. Special effects such as pause, frame advance, slow motion, and picture search work well in this speed.

SLP (Super Long Play) gives three times the recording time of tapes recorded in SP. Special effects such as pause, frame advance, slow motion, and picture search work well in this speed.

Cassette	Recording Time	
	SP	SLP
T-120	2Hrs	6Hrs
T-160	2Hrs 40Min	8Hrs

Normal Recording

To Make a Recording

Turn on the TV and tune it to the VCR viewing channel, either 3, 4, or the TV's video input channel.

1. Insert a tape with its safety tab in place.
2. Press **VCR1 (VCR2•DVD)** to set the remote to control VCR.
3. If you are using one of the basic hookups, make sure the **VCR** indicator appears in the VCR's display panel. If not, press **TV•VCR** to turn it on.
4. Select a recording speed using **SPEED** on the remote.
The tape speed indicator appears in the VCR's display panel and on the TV screen.
5. Select the channel or line input (0L10 or 0L20) to be recorded.
The channel number, 0L1,0 or 0L20 appears in the VCR's display panel and **VIDEO1** or **VIDEO2** appears on the TV screen.
¥ L1: For rear audio/video connection.
¥ L2: For front audio/video connection.
6. Press **REC** on the remote or **RECORD** on the VCR to begin recording. The **REC** indicator (**REC**) and the playback indicator (**▶**) appear in the VCR's display panel while the VCR is recording.
7. Press **STOP•EJECT** on VCR or **VCR** and **TOP** on remote to stop the recording.

Watch a TV Channel While VCR is Recording a Different Channel

1. Follow steps 1 through 6 above.
2. If you are using one of the basic hookups, press **TV•VCR** to switch to the TV channel. The **VCR** indicator turns off in the display panel.
3. Press **TV** to set the remote to control TV functions for a compatible TV.
4. Select the channel you want to watch with the TV's channel buttons.
5. Press **STOP•EJECT** on VCR or **VCR** and **STOP** on remote when recording is finished.

Express Recording

Express recording lets you record up to four hours without using the timer program feature. The VCR turns off automatically at the end of the recording.

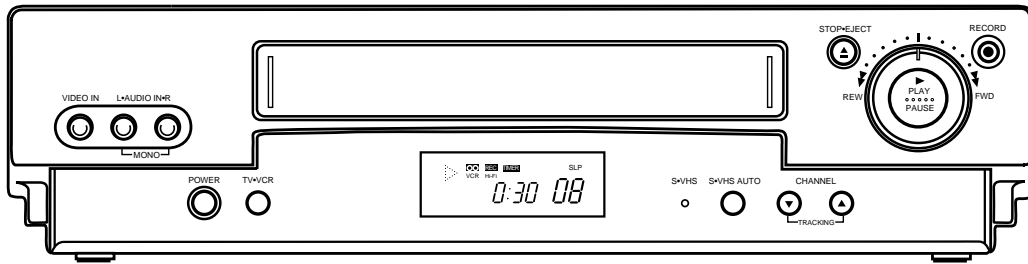

Recording While You're Away (VCR Plus+* Recording)

VCR Plus+ Setup for Antenna, Unscrambled Cable System (Not Requiring a Cable Box), or Cable Box VCR Can Control

A VCR Plus+ channel number is assigned for each broadcast or cable channel. These numbers are listed in most publications that list PlusCode numbers.

1. Prepare a worksheet for the VCR Plus+ channels that are different from the channels you receive them on. Refer to the chart below for standardized VCR Plus+ channel numbers.

2. Press **MENU** on the remote to display the **VCR MAIN MENU** on the TV screen.
3. Press **4** to display **CHANNELS** menu.
4. Press **4** to display **VCR PLUS+ CHANNEL LIST** menu.
5. Using your worksheet, press two numbers to enter each channel number you receive on a **different**

*VCR Plus+ and PlusCode are trademarks of Gemstar Development Corporation.

Recording While You're Away (VCR Plus+ Recording)

The VCR Plus+ and timer program features let you program the VCR to record up to eight different programs within a one year period. Before using VCR Plus+ to record a program, make sure that:

- ¥ The clock is set correctly.
- ¥ A tape with safety tab has been inserted with enough tape to record the programs.
- ¥ The remote is set to control the VCR $\bar{\text{N}}$ using VCR1 (VCR2•DVD).
- ¥ The VCR is set up for VCR Plus+ programming if you:
 - ¥ receive all channels through a cable box or RCA satellite receiver, set up the cable box or receiver as described on pages 10-11.
 - ¥ use an antenna, use a cable box the VCR can control, or do not use a cable box for all channels, complete VCR Plus+ Setup on page 33.

Setting a VCR Plus+ Recording

1. Press MENU on the remote to display the VCR MAIN MENU.
2. Press 1 to display the VCR PLUS+ menu.
3. Press numbers on the remote to enter PlusCode number for the program you want to record. VCR PlusCode numbers are found in most local TV listings.
Press CLEAR on the remote to correct an entry.

4. Press MENU to enter the program.
If the VCR does not recognize the PlusCode number, UNRECOGNIZED NUMBER... PLEASE RE-ENTER appears on the TV screen. Check the number and enter it again.

5. Press 1, 2, 3, or 4 to select type of program.
 - 1 ONE TIME $\bar{\text{D}}$ single program recorded once.
 - 2 DAILY $\bar{\text{D}}$ program recorded at same time every day.
 - 3 WEEKDAYS $\bar{\text{D}}$ program recorded at same time Monday through Friday.
 - 4 WEEKLY $\bar{\text{D}}$ program recorded at same time once a week.

6. Select a recording speed using SPEED, or 1(SP), or 2(SLP) on the remote.
7. Press CLEAR if you want to change the program end time. This feature lets you extend the recording time on VCR Plus+ programs. Also, this option may be useful when you are recording programs such as sporting events that could exceed scheduled broadcast times.
8. Press MENU to enter your program. A reminder appears which will time out or you can press MENU to return to the VCR MAIN MENU.

If you have entered two programs whose times overlap, PROGRAMS OVERLAP appears on the screen.

9. Repeat steps 2 – 6 for additional programs or press MENU to remove the menu from the TV screen.

10. **Turn off the VCR** before recording time.

The (TIMER) indicator appears in the VCR's display panel when the timer has been programmed.

11. **Manually Controlled Cable box or Satellite Receiver:** Turn on the cable box or satellite receiver and tune it to the channel you want to record before the time the recording is to begin.

Remote Controlled Cable box: Turn on the cable box before the time the recording is to begin.

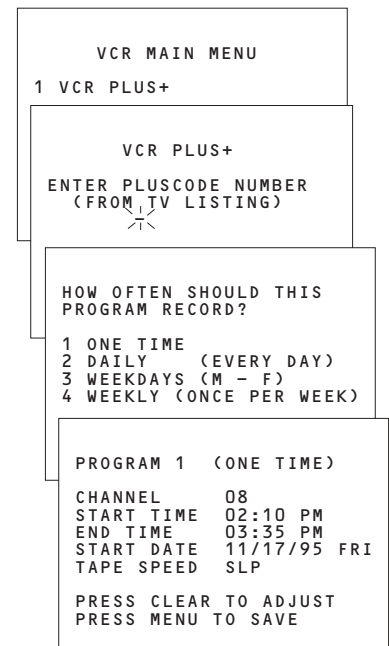

Stopping a Timer Recording

You can stop a recording by pressing and holding the STOP button on the remote or STOP•EJECT on the VCR for approximately three seconds.

Recording While You're Away (Timer Recording)

The timer program and VCR Plus+ features let you program the VCR to record up to eight different programs within a one year period. Before setting the timer, make sure that:

- ¥ The clock is set correctly.
- ¥ A tape with its safety tab in place has been inserted and has enough tape to record the programs.
- ¥ The remote is set to control the VCR \bar{N} using VCR1 (VCR2•DVD).
- ¥ If you receive all channels through a cable box or RCA satellite receiver, set up the cable box or receiver as described on pages 10-11.

Setting a Timer Recording

1. Press **MENU** on the remote to display the VCR MAIN MENU.
2. Press **2** to display the **TIMER RECORDINGS** menu.
3. Press **1** to display the **CREATE A NEW PROGRAM** menu.
4. Press **1, 2, 3, or 4** to select type of program.
 - 1 **ONE TIME** \bar{N} single program recorded once.
 - 2 **DAILY** \bar{N} program recorded at same time every day.
 - 3 **WEEKDAYS** \bar{N} program recorded at same time Monday through Friday.
 - 4 **WEEKLY** \bar{N} program recorded at same time once a week.

5. Press number buttons on the remote to enter the channel number (or **INPUT** to select 0L10 or 0L20), start time including AM or PM, end time, start date, and recording speed of the recording. Just follow the on-screen prompts.

Press **CLEAR** on the remote to correct an entry.

If you receive all channels from a cable box or satellite receiver and have completed **CABLE BOX SETUP** and the cable box is not controllable, the output channel of your cable box or receiver and **CABLE** automatically appear on the menu.

6. Press **MENU** to enter your program. A reminder appears which will time out or you can press **MENU** to return to the **TIMER RECORDINGS** menu.

If you have entered two programs whose times overlap, **PROGRAMS OVERLAP** appears on the screen.

7. Repeat steps 3–6 for additional programs or press **MENU** twice to remove the menu from the TV screen.
8. **Turn off the VCR** before recording begins.

The (**TIMER**) indicator appears in the VCR's display panel when the timer has been programmed.

9. **Manually Controlled Cable box or Satellite Receiver:** Turn on the cable box or receiver and tune it to the channel you want to record before the time the recording is to begin.

Remote Controlled Cable box: Turn on the cable box before the time the recording is to begin.

Note: When entering information in the on-screen display, the VCR will produce an audible tone if the data entered is incorrect.

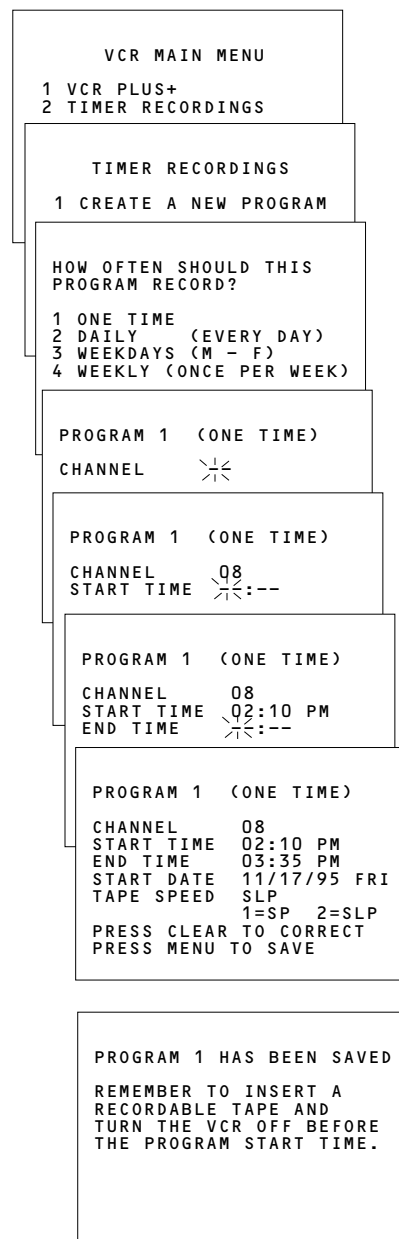

Stopping a Recording in Progress

You can stop a recording by pressing and holding the **STOP** button on the remote or **STOP•EJECT** on the VCR for approximately three seconds.

Recording While You're Away

Checking or Clearing VCR Plus+ or Timer Recordings

1. Press **MENU** on remote to display **VCR MAIN MENU** on TV screen.
2. Press **2** to display the **TIMER RECORDINGS** menu.
3. Press **2** to display the **REVIEW EXISTING PROGS.**
4. Press **MENU** for the next program information or press **CLEAR** to erase the program.

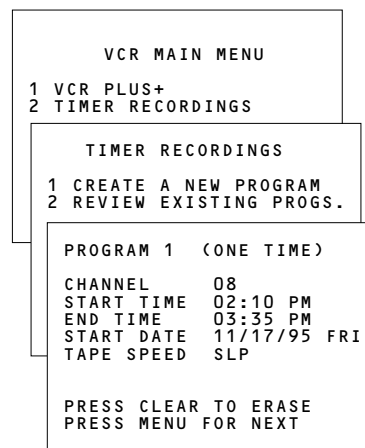

Timer Recording From the VCR's Line Input

The line input refers to the signal coming from the **AUDIO1**, **AUDIO2**, **S-VIDEO**, **VIDEO1** or **VIDEO2 IN** jacks of the VCR. Recording from the line input is convenient if you have a satellite receiver or similar component attached to these jacks. To timer record from the component connected to the VCR's line input: press **INPUT** to enter **VIDEO 1** or **VIDEO 2** instead of the channel number on the TV screen during timer programming.

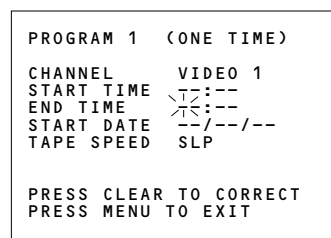

Using the Recording Features

Recording Pause

To prevent recording short passages of unwanted material, use **PAUSE** during recording to stop and start recording. The VCR automatically switches from pause to stop after a few minutes.

Pro-Tect Plus™ (Child Lock) Feature

This feature is useful to tamper proof your timer recordings from unwanted changes and/or protect the VCR from misoperation by other users in the household

To Lock the VCR

Press and hold **PWR** (Power) on the remote for approximately six seconds to turn on the Pro-Tect Plus[®] feature.

The word "SAFE" appears in the front display panel.

To Unlock the VCR

Press and hold **PWR** on the remote for approximately six seconds to unlock the VCR.

Broadcast Stereo TV or SAP (Second Audio Program)

Some TV programs are broadcast with stereo audio or a second audio language (SAP). The RECEPTION: STEREO/MONO/SAP feature lets you select the type of audio you want to record.

To Record Stereo Broadcast TV or SAP

Turn on the TV and tune it to the VCR viewing channel, either 3, 4, or the TV's video input.

1. Insert a tape with its safety tab in place.
2. If using one of the basic hookups, make sure the VCR indicator appears in the VCR's display panel. If not, press TV•VCR to turn it on.
3. Use SPEED on the remote to select a recording speed.
The tape speed indicator appears in the VCR's display panel and on the TV screen.
4. Select the channel, 0L10 (Rear connection), or 0L20 (Front connection) to be recorded.
Channel number, 0L1,0 or 0L20 appears in the VCR's display panel.
5. Set the RECEPTION:STEREO/MONO/SAP feature for the type of audio you want to record.
 - A. Press MENU to display the VCR MAIN MENU on the TV screen.
 - B. Press 6 to display the AUDIO menu.
 - C. Press 1 to select the type of audio RECEPTION: STEREO, MONO, or SAP.
 - ¥ Set to STEREO for normal or stereo broadcast TV recording.
STEREO indicator lights in the VCR's display panel when the station you are tuned to is broadcasting stereo.
 - ¥ Set to MONO if the stereo signal is weak and the sound is too noisy.
 - ¥ Set to SAP to record SAP (second audio program) instead of the normal audio on both the hi-fi and linear tracks.
SAP indicator lights in the VCR's display panel when the station you are tuned to is broadcasting SAP.
 - D. Repeatedly press 0 to remove the menus from the TV screen.
6. Press REC on remote or RECORD on the VCR to start recording.
The record indicator (REC) and the playback indicator (▶) appear in the VCR's display panel.
7. Press STOP•EJECT on the VCR or STOP on the remote when you are finished.

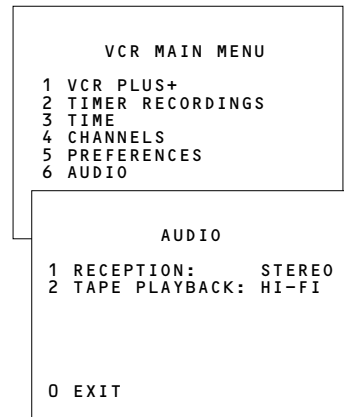

Recording Audio Only

You can record audio only from another audio source connected to the AUDIO1 or AUDIO2 IN (L and R) jacks on the back of the VCR. Any video on the tape will be erased when you record audio only.

To Record Audio Only

1. Press the INPUT button on remote until the line indicator 0L1 (Rear connection) or 0L2 (Front connection) appears in the VCR's display panel.
The VCR records audio from the audio equipment connected to the AUDIO1 or AUDIO2 IN jacks.
2. Use SPEED on the remote to select the recording speed.
The tape speed indicator appears in the VCR's display panel and on the TV screen.
3. Start playing the audio source. Then, press REC on remote or RECORD on the VCR to begin recording.
The record indicator (REC) and the playback indicator (▶) appear in the VCR's display panel.
4. Press STOP/EJECT on the VCR or STOP on the remote when you are finished.

To Play Back Audio Only

Connect the AUDIO OUT of the VCR to the appropriate input on your amplifier or receiver. Do not use the phono input. Refer to your amplifier or receiver user's guide for information.

S-VHS Recording ()

The VCR is capable of recording in VHS or Super-VHS format. To record in S-VHS, use cassettes labeled with the S-VHS symbol. It is not possible to record in S-VHS using a standard VHS tape. S-VHS tapes must be played back in a VCR with S-VHS. S-VHS recordings cannot be played back in VCRs that do not have the S-VHS symbol. Refer to the chart below for the results.

- ¥ To record in S-VHS, push the S-VHS AUTO button. The S-VHS indicator light turns on when no tape or an S-VHS tape is inserted. The indicator does not turn on when a VHS tape is inserted.
- ¥ To turn off S-VHS and record in VHS, push S-VHS AUTO button. The S-VHS AUTO indicator light turns off.

Using Two VCRs for Copying and Editing Tapes

Operating Instructions (Refer to hookup on page 8.)

Use one VCR as the playback VCR and the other as the recording VCR.

Caution: The unauthorized recording of television programs and other materials may infringe the rights of others.

1. Turn on the TV and VCRs.
2. Tune TV to the VCR viewing channel, either 3, 4, or the TV's video input.
3. If you have connected your VCR using Option A (page 8), tune recording VCR to channel 3 or 4 \bar{N} the one selected on the back of the playback VCR.
If you have connected your VCR using Option B (page 8), press INPUT on recording VCR to select the line input. 0L10 or 0L20 appears in VCR's display panel.
4. Insert the tape you want to copy into playback VCR. Insert a blank tape with safety tab in place into recording VCR.
5. Press PLAY, then PAUSE on playback VCR when you reach the point on the tape or program where you want to begin copying. If the tape was not recorded on the playback VCR, streaks may appear and you may need to adjust tracking. To prevent recording on-screen displays from the playback VCR, press DISPLAY button three times.
6. Press RECORD on the VCR or REC on the remote, then PAUSE, on recording VCR.
7. Press PAUSE buttons on both VCRs at the same time to begin copying the tape.*
8. Edit out segments that you do not want to copy by pressing PAUSE on recording VCR to stop copying the tape. Then, locate the next segment you want to copy on playback VCR by using SHUTTLE DIAL, and PAUSE. Press PAUSE on the playback VCR. Press PAUSE at the same time on both VCRs to resume copying.
9. Press STOP•EJECT on both VCRs when you are finished.

* You can turn off the TV after the recording has started as it does not have to be on to copy a tape.

Using Dual Remote with AutoEdit™

Use this VCR as the recording VCR and set it to respond to VCR2•DVD on the remote as described in the section, 0Controlling a VCR.0 Use your other compatible VCR as the playback VCR, which should respond to VCR1.

1. Follow steps 1 – 4 in the 0Operating Instructions0 above.
2. Press VCR2•DVD on remote to control recording VCR. Press REC, then PAUSE, to put recording VCR in pause mode.
3. Press VCR1 on remote to control playback VCR.
4. Use FWD, REW, and PLAY to locate the point where you want to begin copying. Press PAUSE while VCR is playing to put playback VCR in pause mode.
5. Press EDIT on remote to start the VCRs copying.
6. Press EDIT again when you want to stop the tape from copying.
7. Repeat steps 4 – 6 as needed.

Location of Controls

Front Panel

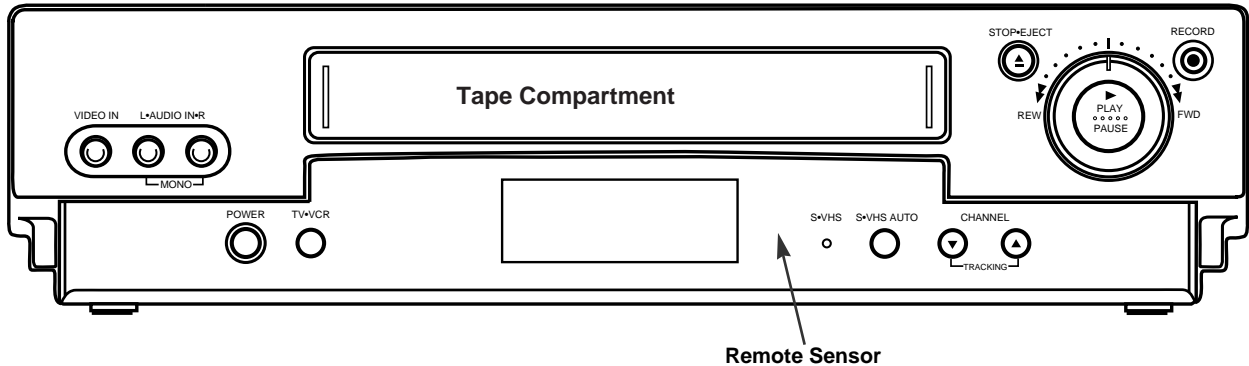

CHANNEL or TRACKING Up or Down

Selects next higher or lower channel in the VCR's channel memory.

Adjusts tracking during playback.

PLAY•PAUSE

Plays a tape.

Pauses the tape for stop-action viewing during playback.

Pauses the tape during recording to prevent recording unwanted material.

POWER

Turns the VCR on or off.

RECORD

Starts the VCR recording.

Used for express recording.

Remote Sensor

Receives signals from the remote control. Aim the remote at this sensor with no objects between them.

S-VHS AUTO

Selects VHS or S-VHS recording. See the *S-VHS Recording* section.

S-VHS (Indicator)

Lights during S-VHS recording or playback.

SHUTTLE DIAL

Places the VCR in Shuttle mode and starts a forward or reverse search when you turn the dial while in Play or Still mode.

STOP•EJECT

Stops the normal functions such as record, playback, rewind, fast forward, or pause.

Ejects a tape when the VCR is stopped.

TV•VCR (Applies only to basic hookup)

Switches the picture signal so that it either comes from the VCR or the TV channel. See *Use the TV/VCR Button in the Startup* section.

VIDEO and AUDIO (R and L) IN Jacks

Receives signals from another component, such as a VCR or camcorder, when it is connected to these jacks.

Display L2 in the VCR display panel using INPUT on the remote to select these jacks.

Location of Controls

Back Panel

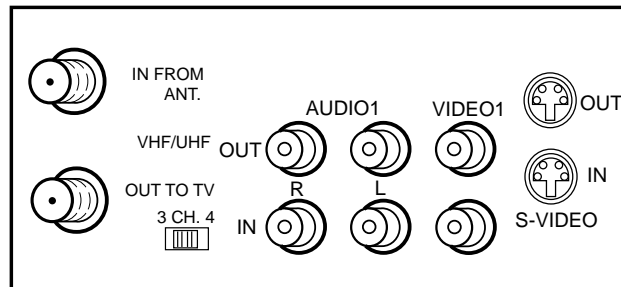

3 CH. 4 Switch

Selects the channel to which you will tune the TV to see the VCR picture if you connect the VCR using one of the basic hookups.

IN FROM ANT. (Antenna) Connector

Receives a signal from an antenna or cable system when attached.

OUT TO TV Connector

Passes signal to TV using the cable supplied.

S-VIDEO OUT and IN Connectors

Lets you attach another S-VHS component to the S-VIDEO IN connector using the included S-VHS cable. Use INPUT on the remote to display L1 in the VCR's display panel to select.

Lets you attach the S-VIDEO OUT connector to a TV monitor having an S-VIDEO IN connector to take full advantage of the S-VHS format.

Also, remember to attach the audio jacks. The S-VHS cable carries only video.

VIDEO1 and AUDIO1 (R and L) IN Jacks

Receives signals from another component, such as a VCR or camcorder, when it is connected to these jacks.

Display L1 in the VCR display panel using INPUT on the remote to select these jacks.

VIDEO1 and AUDIO1 (R and L) OUT Jacks

Sends signals from VCR to another component, such as a monitor TV or another VCR, when it is connected to these jacks.

If the other component is not stereo, you may need a Y-adaptor to hear both channels.

Location of Controls

Display Panel

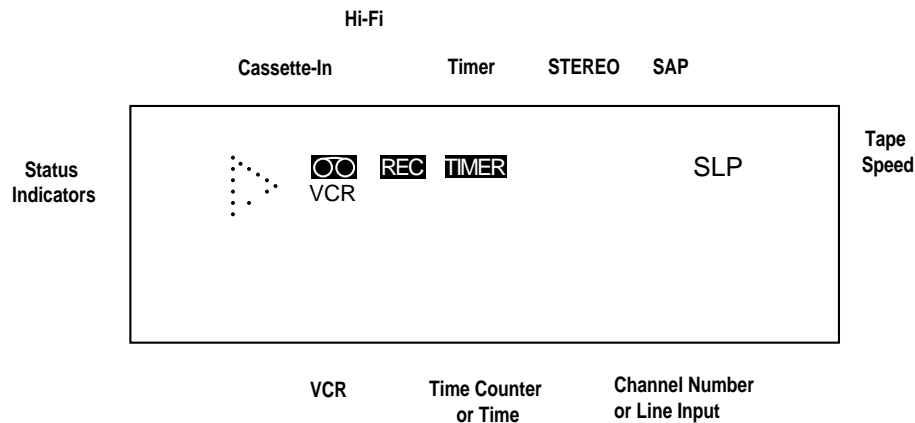

Cassette-in Indicator (📀)

Lights when a tape is in the VCR.

Channel Number or Line Input (0L10 or 0L20)

The channel number or line input is displayed. Press INPUT on the remote to light 0L10 or 0L20 to record from the VIDEO1 or VIDEO2 and AUDIO1 or AUDIO2 IN jacks on the back or front of the VCR.

Hi-Fi Indicator

Lights when AUDIO PLAY is set to HI-FI or MIX.

Repeat Indicator (🔄)

Lights when the repeat play is performed.

SAP Indicator

Lights when the station you are tuned to is broadcasting SAP.

Status Indicators

Show what the VCR is doing in the display panel.

REC and ▶	Record
REC and	Record-pause
▶	Playback
◀	Reverse playback
	Play-pause
	Frame advance
I ▶	Slow motion
I ◀	Reverse slow motion
◀ flashing	Rewind
◀ flashing	Reverse search
▶ flashing	Fast forward
▶ flashing	Forward search
flashing	Cassette ejecting
SAFE	VCR locked or unlocked

STEREO Indicator

Lights when the station you are tuned to is broadcasting stereo.

Tape Speed Indicators (SP, LP, or SLP)

Tape speed. Press SPEED on remote to change.

Time or Time Counter

Press DISPLAY on remote to switch between the current time and elapsed-time counter.

TIMER Indicator

Lights when VCR is set for timer recording and VCR is turned off or XPR recording is performed. Flashes if tape is not inserted.

VCR Indicator (Applies Only to Basic Hookups)

Press TV•VCR to turn on or off.

VCR indicator on: Picture from VCR.

VCR indicator off: Picture from TV channel.

Trouble Checks

Sometimes problems can be easily solved by checking a few basic things. Check below before you call for help or take your VCR to an Authorized RCA VCR Servicer.

Trouble	Here's what to try:
No power	<ul style="list-style-type: none"> ¥ Plug VCR into an operating outlet. ¥ Check connections.
VCR does not respond to remote	<ul style="list-style-type: none"> ¥ Remove batteries and hold down one or more buttons for several seconds to drain the microprocessor inside the remote and reset it. Re-install the batteries and try remote again. ¥ Press VCR1 (VCR2•DVD)) to set remote to control the VCR. <i>See page 18.</i> ¥ Aim remote at VCR with no objects between them. ¥ Change batteries. ¥ Check the Pro-Tect^a feature.
Remote no longer controls a compatible TV, cable box, or auxiliary component	<ul style="list-style-type: none"> ¥ Press TV, AUX, or CABLE to set remote to control the corresponding component. <i>See pages 19-21.</i> ¥ Aim remote at TV with no objects between them. ¥ Reprogram remote after batteries have been changed. <i>See pages 19-21.</i> ¥ Change batteries. ¥ Check the Pro-Tect^a feature. ¥ Reprogram remote for specific component. <i>See pages 19-21.</i>
VCR only responds to VCR2•DVD button on remote	<ul style="list-style-type: none"> ¥ Check setting of REMOTE CONTROL: VCR1/VCR2 feature. <i>See page 18.</i>
Poor or no picture for normal TV viewing	<ul style="list-style-type: none"> ¥ Press TV•VCR to turn VCR indicator off. ¥ Switch TV to an active channel. ¥ Check antenna connections.
Snowy or no picture during playback	<ul style="list-style-type: none"> ¥ Press TV•VCR to turn VCR indicator on. ¥ Check TV channel selected (3 or 4) to make sure it matches the channel selected with 3 CH. 4 switch on back of VCR. ¥ Check TV's fine tuning. ¥ Check video cable connections between VCR and TV monitor. ¥ Set TV monitor to video input channel. ¥ Try another tape. ¥ Some snow/streaks are normal during search, stop action, frame advance, and slow-motion playback.
Streaks in picture during normal playback	<ul style="list-style-type: none"> ¥ Press the TRACKING buttons to move streaks up or down for the best picture. ¥ Check tape \bar{N} it may be worn out or of poor quality.
Time counter not working or not advancing during search mode.	<ul style="list-style-type: none"> ¥ The time counter does not advance during unrecorded portions of tape. When an unrecorded segment of tape is encountered, the time counter will hold its count until recorded material is detected again. ¥ A minus (D) will appear in front of the time if you rewind the tape farther back than a counter reading of 0:00:00.
Will not record	<ul style="list-style-type: none"> ¥ Safety tab removed from cassette. ¥ Make sure the line indicator (0L10 or 0L20) is turned off in VCR's display panel for normal recording from the VCR's tuner. Press INPUT on remote to turn off the line indicator. ¥ Check the Pro-Tect^a feature.

Trouble Checks

Trouble	Here's what to try:
Will not record or play	<ul style="list-style-type: none"> ¥ No cassette in VCR. ¥ Eject and reinsert cassette. ¥ Broken tape Ñ try another cassette. ¥ VCR is in pause mode. Press PLAY•PAUSE on the VCR or PAUSE on the remote. ¥ Pressing JOG SHUTTLE during playback places VCR in pause mode. Press PLAY•PAUSE on the VCR or PLAY on the remote, or PAUSE to return to normal playback. ¥ Check the Pro-Tect^a feature.
Rewind does not operate	¥ Tape already rewound.
VCR plus+ or timer recording not made or wrong program recorded	<ul style="list-style-type: none"> ¥ Wrong VCR plus+ code entered. ¥ Cable box setup not done or not done correctly. <i>See pages 10-11.</i> ¥ Cable box was not turned on at time recording was to begin. ¥ Program entered incorrectly (wrong channel or times). ¥ Power interruption. Clock area in display panel will show --:--. ¥ Check to see if time and date are correct Ñ including AM/PM. ¥ Program exceeded tape's length or tape was not rewound beforehand. ¥ VCR was not turned off at the time recording was to start. ¥ No tape in VCR or cassette's safety tab broken off. ¥ VCR ejects cassette when the end of the tape is reached during a timer recording.
Clock shows incorrect time or date	<ul style="list-style-type: none"> ¥ Power interruption and AUTO CLOCK SET is turned OFF. Clock on the front panel will show --:--. ¥ Clock was not set accurately (check AM/PM and date). ¥ Time counter display appears in VCR's display panel. Press DISPLAY on remote.
VCR makes noise when stopped	<ul style="list-style-type: none"> ¥ VCR is removing tape from heads. This is normal. The head cylinder inside the VCR will continue to rotate for a few minutes after you put the VCR in the stop mode.
Will not AUTO-SEARCH active channels correctly	<ul style="list-style-type: none"> ¥ Check antenna connections. ¥ Check SIGNAL TYPE: CABLE/ANTENNA feature.
Tape plays back in slow motion	<ul style="list-style-type: none"> ¥ Press PLAY•PAUSE on the VCR or PLAY on the remote to return to normal playback.
Cannot select channels over 69	<ul style="list-style-type: none"> ¥ Cable channels over 69 can only be selected if SIGNAL TYPE: CABLE/ANTENNA feature is set to CABLE. <i>Details are on page 13.</i>
Cassette with safety tab removed does not start to play automatically	<ul style="list-style-type: none"> ¥ Set AUTO PLAY ON/OFF feature to ON. <i>Details are on page 22.</i>
Stereo or SAP sound not recorded	<ul style="list-style-type: none"> ¥ RECEPTION: STEREO/SAP/MONO feature must be set to STEREO to record broadcast stereo. <i>See page 38.</i> ¥ RECEPTION: STEREO/SAP/MONO feature must be set to SAP to record SAP. <i>See page 38.</i> ¥ STEREO or SAP indicator not on. Station not broadcasting stereo or SAP.
No stereo sound during playback	<ul style="list-style-type: none"> ¥ TAPE PLAYBACK: HI-FI/MIX/LINEAR feature must be set to HI-FI to hear stereo sound during playback. <i>See page 27.</i>

Trouble Checks

Trouble	Here's what to try:
Stereo audio too noisy	<ul style="list-style-type: none"> ¥ Stereo signal is weak. Set RECEPTION: STEREO/SAP/MONO feature to MONO. ¥ Press one of the TRACKING up or down buttons to minimize the noise.
S-VHS recording not made or no sound during playback	<ul style="list-style-type: none"> ¥ Check position of S-VHS AUTO switch on VCR. <i>See page 39.</i> ¥ A tape with S-VHS must be used to make S-VHS recordings. ¥ Make sure the component's S-VIDEO connectors are connected using an S-VHS cable. ¥ Be sure to also connect the audio cables. The S-VHS cable carries only video.
Tape plays over and over	<ul style="list-style-type: none"> ¥ Check setting of AUTO REPEAT ON/OFF menu. <i>See page 25.</i>
Jog shuttle arrow buttons will not function	<ul style="list-style-type: none"> ¥ Press JOG SHUTTLE button to turn on jog shuttle buttons. Indicator will light. ¥ Indicator light off. Pressing any other button during jog shuttle operation will turn off jog shuttle. Press JOG SHUTTLE to turn jog shuttle back on.
Tape continues forward or reverse search during jog shuttle operation	<ul style="list-style-type: none"> ¥ Press PLAY•PAUSE on the VCR or PLAY on the remote to return to normal playback. ¥ Press ▼ or ▲ to place VCR in pause mode.
VCR forwards through commercials or momentarily displays a blue screen during playback	<ul style="list-style-type: none"> ¥ COMMERCIAL▶▶ADVANCE^a CA PLAYBACK feature set to AUTO. <i>See pages 29-30.</i>
VCR forwards through a rental or pre-recorded tape displaying a blue screen	<ul style="list-style-type: none"> ¥ Some tapes use special control track marking. Set the COMMERCIAL▶▶ADVANCE^a CA PLAYBACK feature, in the PREFERENCES menu to MANUAL.
COMMERCIAL▶▶ADVANCE ^a feature does not mark commercials	<p>The commercial advance feature does not mark commercials under the following situations:</p> <ul style="list-style-type: none"> ¥ CA Marking: ON/OFF feature set to OFF. <i>See page 29.</i> ¥ Recording is less than 15 minutes. ¥ A single isolated commercial cannot be marked. ¥ Recording started in the middle of a commercial segment. ¥ The commercial is longer than one minute. ¥ A commercial group within the first or last two minutes of a recording. ¥ It does not mark commercials between 30-and-45 seconds and 45-and-60 seconds. ¥ Accuracy and effectiveness can vary depending upon program content and the characteristics of the commercials. ¥ Effectiveness may vary when local television stations insert their own commercials.
Commercials recorded even though COMMERCIAL▶▶ADVANCE ^a feature was turned on.	<ul style="list-style-type: none"> ¥ COMMERCIAL▶▶ADVANCE^a is designed to record the commercials, mark them, and then skip over the marked commercials during playback.

Questions and Answers About **COMMERCIAL▶▶ADVANCE™**

Question	Answer
Will commercials be scanned through only on playback of recordings?	Yes. The VCR does not rewind and mark commercial segments until after recording is finished.
How fast does the COMMERCIAL▶▶ADVANCE ^a VCR scan through the commercial breaks?	In SLP tape speed, a 3-minute commercial break is scanned through in approximately 8-12 seconds. In SP, it takes about 25-35 seconds.
Are commercials still recorded if I want to watch them?	Yes. The recorded program, including commercials, can be viewed by setting the CA PLAYBACK feature to MANUAL.
What if the VCR scans forward through part of my program?	Simply rewind the tape to just before the skipped segment, and press PLAY to view the program.
Once a recording has been marked, does COMMERCIAL▶▶ADVANCE ^a work each time the tape is played?	Yes. If the CA PLAYBACK feature is set to AUTO, the marked commercials should be skipped each time the tape is played in a COMMERCIAL▶▶ADVANCE ^a VCR.
After marking commercials, is the tape left at the beginning or end of the recording?	The tape is left at the end of the recording so it is in position to begin additional programmed recordings.
Does the marking process interfere with other programmed recordings?	No. If two or more recordings are programmed together without sufficient time to mark the first recording, marking will take place after all recordings have completed.
What happens if the marking process is interrupted?	Marking can be interrupted to allow use of the VCR. Marking will resume again when the VCR's power is turned off as long as the tape has not been ejected from the VCR.
Does COMMERCIAL▶▶ADVANCE ^a work in all recording speeds?	Yes, COMMERCIAL▶▶ADVANCE ^a works in SP and SLP.
Will COMMERCIAL▶▶ADVANCE ^a marked recordings work in non-COMMERCIAL▶▶ADVANCE ^a VCRs?	A COMMERCIAL▶▶ADVANCE ^a marked recording will play in a non-COMMERCIAL▶▶ADVANCE ^a VCR, but commercials will not automatically be skipped.

Specifications

Format:	S-VHS
Record/Playback System:	Video: 4-Head Audio: 2 Hi-Fi record/playback system Flying Erase Head
Video Signal System:	EIA standard: NTSC color
Antenna:	75-ohm external VHF/UHF combined antenna terminal
Tuner:	USA: 181 channels capability* (125 cable channels) Canada: 178 channels capability* (122 cable channels)
Type:	AutoProgramming frequency synthesis
Power Requirement:	120V AC, 60 Hz
Power Consumption:	28 watts
Dimensions:	3.5 inches high (89 mm) 15 inches wide (380 mm) 11.5 inches deep (292 mm)
Weight:	9.5 pounds (4.3 kg)
Storage Temperature Range:Range:	- 22°F to +149°F (-30°C to +65°C)
Operating Temperature Range:	+41°F to +104°F (+5°C to +40°C)

*Check your cable company's compatibility requirements.

Cleaning the VCR

Use a soft cloth or dusting attachment of your vacuum cleaner to dust your VCR. Remove dust from the ventilation holes on the top, back, sides, and bottom of the cabinet.

Plastic surfaces are easily scratched and can be marred by alcohol and various solvents. Avoid excessive use of oil-based furniture polishes since the materials used in the cabinet will accumulate more dust. We recommend using a non-abrasive, anti-static cleaner and polisher.

Limited Warranty

What your warranty covers:

- ¥ Any defect in material or workmanship.

For how long after your purchase:

- ¥ Ninety days for labor charges.
- ¥ One year for parts.

The warranty period for rental units begins with the first rental or 45 days from date of shipment to the rental firm, whichever comes first.

What we will do:

- ¥ Pay any Authorized RCA VCR Servicenter the labor charges to repair your VCR.
- ¥ Pay any Authorized RCA VCR Servicenter for the new or, at our option, refurbished replacement parts required to repair your VCR.

How you get service:

- ¥ Take your VCR to any Authorized RCA VCR Servicenter. To identify your nearest Authorized RCA VCR Servicenter, ask your dealer, look in the Yellow Pages, or call 1-800-336-1900.
- ¥ Show the service technician your evidence of purchase date.
- ¥ Pick up your VCR when repairs are completed.

What your warranty does not cover:

- ¥ Customer instruction. (Your Owner's Manual clearly describes how to install, adjust, and operate your VCR. Any additional information should be obtained from your Dealer.)
- ¥ Installation and related adjustments.
- ¥ Signal reception problems not caused by your VCR.
- ¥ Damage from misuse or neglect.
- ¥ Cleaning of video/audio heads.
- ¥ Remote control batteries.
- ¥ A VCR that has been modified or incorporated into other products or is used for institutional or other commercial purposes.
- ¥ A VCR purchased or serviced outside the USA.
- ¥ Acts of God, such as but not limited to lightning charge.

Product Registration:

- ¥ Please complete and mail the Product Registration Card packed with your VCR. It will make it easier to contact you should it ever be necessary. The return of the card is not required for warranty coverage.

How state law relates to this warranty:

- ¥ This warranty gives you specific legal rights, and you also may have other rights that vary from state to state.

If you purchased your VCR outside the United States:

- ¥ This warranty does not apply. See your dealer for details.

Index

3 CH. 4 Switch	3-8,42
Accessories, Included	9
Add or Remove Channels Memory	14
ADD/REMOVE CHANNEL Menu	14
Antenna Connections	2,3
Antenna Signal Type	13
Arrow Buttons	16,28
AUDIO and VIDEO IN Jacks	6,7,8,37,39,42
AUDIO and VIDEO OUT Jacks	3-8,39,42
Audio Components, RCA	21
AUDIO Menu	27,38,39
AUTO, Display Panel	15
AUTO PLAY Feature	23
AUTO REPEAT Feature	25
AUTO TV/VCR Feature	14,22
AUTO CHANNEL SEARCH Feature	13
Auto Clock Set	12
Automatic Tracking	25
AUX (Auxiliary) Button	16,21
Auxiliary Component, Controlling an	21
Back Panel	42
Batteries, Inserting in Remote	9
Blank Search Feature	27
BLANK SEARCH Menu	27
BRIGHT, Display Panel	15
Broadcast Stereo, Recording	38
CA DISPLAY Feature	30
CA MARKING Feature	29
CA PLAYBACK Feature	30
CABLE BOX SETUP Menu	10,11
CABLE Button	16,17,20
Cable Box Codes	11,20
Cable Box Function Buttons	17
Cable Box, Programming Remote	20
Cable Signal Type	13
Cable System With Cable Box Connections	2,4,5
Cable System Without Cable	
Box Connections	2,3
Card, Registration	i
CHAN (Channel) Up or Down Buttons	14,16,17
CHANNEL Buttons	14,41
CHANNELS Menu	14,33,34

Index

- Two VCRs 8
- ID, Station 24
- IN FROM ANT (Antenna) Connector 3-8,42
- INDEX SEARCH 26
- INPUT Button 16,36,37,39,40-43
- JOG SHUTTLE Button and
 - Indicator 16,28
- L1 and L2, VCR Display Panel 8,31,37,38,42,43
- Laserdisc Player Codes 19
- Laserdisc Player, Controlling 18
- Limited Warranty 49
- Line Indicator (L1 or L2) 8,31,42,43
- Line Input, Timer Recording From 37
- LINEAR, Playback 27
- Location of Controls
 - Remote Control 16,17
 - VCR Back Panel 42
 - VCR Display Panel 43
 - VCR Front Panel 41
- Lock the VCR 37
- LP Speed 31
- Manual Tracking 25
- MENU•PROG Button 16,17
- MIX, Playback 27
- MUTE Button 16,17
- Number Buttons 16,17
- On-Screen Displays 24
- Operating Instructions
 - Copying Tapes 40
 - Express Recording 32
 - Playing a Tape 22
 - Recording a Program 31
 - S-VHS Recording 39
 - Timer Recording 36
 - VCR Plus+ Recording 33-35
- OUT TO TV Connector 3-8,42
- PANEL DISPLAY Feature 15
- PAUSE Button 16,17,22,25,40
- Pause for Stop Action 25
- Pause, Recording 37
- Picture Search 23,28
- PLAY Button 16,17,22,23,40
- PLAY•PAUSE Button 22,25,40,41
- TAPE PLAYBACK:
 - HI-FI/LINEAR/MIX Feature 27
 - Playing a Tape 22-28
- POWER Button 37,41
- PWR Button 16,17,37
- PREFERENCES Menu 14,15,23,25,29
- PREV CH (Previous Channel) Button 16,17
- Pro-Tect Plus^a Feature 37
- Product Registration i
- Programming Remote for Cable Box 20
- Programming Remote to Control DVD 18
- Programming Remote to Control
 - Laserdisc Player 18
- Programming Remote to Control VCR 18
- Programming Remote to Control TV 19
- REC Button 16,17,31,32,40
- REC Indicator 31,32,40,43
- RECORD Button 31,32,40,41
- RECEPTION: STEREO/MONO/
 - SAP Feature 38
- Recording
 - Audio Only 39
 - Broadcast Stereo TV 38
 - Express 32
 - From Another VCR 40
 - Normal 31
 - One Program While Watching Another 31
 - Pause 37
 - S-VHS 39
 - SAP (Second Audio Program) 38
 - Speeds 31
 - Timer 36
 - VCR Plus+ 33-35
- Recording Audio Only 39
- Recording, Normal 31
- Registration Card i
- Remote Control 16,17
- Remote Sensor 41
- Remove or Add Channels from Memory 14
- REMOVE/ADD CHANNEL Menu 14
- Repeat Indicator 25,43
- REW (Rewind) Button 16,17,23,26,41
- S-VHS
 - AUTO Button 39,41
 - Connectors 3-8,42
 - Indicator 39,41
 - Recording 39
 - Recording Chart 39
- SAFE Indicator 37,43
- Safety Precautions i
- Safety Tab 22
- SAP Indicator 38,43
- SAP, Recording 38
- SAT•CABLE Button 16,17,20
- Satellite Receiver
 - Codes 20
 - Connections 6,7
 - Controlling 20
 - Function Buttons 17
 - Setup 11
- SEARCH Button 16,17,26,27

Index

- Search, Picture23,28
- Select a Playback Sound27
- Sensor, Remote41
- Set the clock13
- Set the clock automatically12
- Set the channel search automatically13
- Setting a VCR Plus+ Recording35
- Setting Up the VCR9-15
- Set Up Cable Box10,11
- SHUTTLE DIAL23,24,26,28,41
- SIGNAL TYPE13
- SLOW + and – Buttons16,17,23
- Slow Motion23
- SLP Speed31
- SP Speed31
- Specifications48
- SPEED Button16,17,32,35,36,38,39
- Speeds, Recording31
- Station ID24
- Status Displays24
- Status Indicators43
- STEREO Indicator38,43
- Stereo TV, Recording38
- STOP Button16,17,22
- STOP•EJECT Button22,41
- Stop Action Pause25
- Stopping an Express Recording32
- S-VIDEO
 - AUTO Button39,41
 - Connectors3-8,42
 - Indicator39,41
 - OUT and IN Connectors42
 - Recording39
 - Recording Chart39
- Tape Speed Indicators31,43
- Tape, Playing22-28
- Time Counter24,43
- Time Display43
-  Indicator32,35,36,43
- TIME Menu12
- Time Zone12
- Timer Recording36
- Timer Recording
 - Checking37
 - Clearing37
- Setting36
- Stopping36
- TRACKING Up and Down
 - Buttons16,17,22,23,25,41
- Tracking, Automatic25
- Tracking, Manual25
- Trouble Checks44-46
- Turn On VCR10
- TV Button16,17,19
- TV Codes19
- TV Function Buttons17
- TV•VCR Button3-8,16,17,31,41
- Unlock the VCR37
- Using the Remote16-21
- VCR Controls41-43
- VCR Function Buttons16,17
- VCR Indicator10,14,43
- VCR PLUS+ CHANNEL LIST Menu34
- VCR PLUS+ Menu33
- VCR Plus+ Recording
 - Checking37
 - Clearing37
 - Setting35
 - Setup33,34
 - Stopping35
- VCR, Cleaning48
- VCR, Turn On10
- VCR1 Button10,14,16,18,31,40
- VCR2•DVD Button16,18,31,40
- VCR1/VCR2 Feature18
- VCR's Memory, Placing Channels In13
- VCRs, Connecting for Tape Copying8
- VIDEO and AUDIO IN Jacks (Front)41
- VIDEO and AUDIO IN Jacks (Back)42
- VIDEO1 and VIDEO2
 - TV On-Screen Displays31,37,43
- VOL (Volume) Up or Down Button16,17
- Warranty, Limited49
- XDS (Extended Data Services)12
- ZERO SEARCH Menu26
- Zero Search Feature26
- Zone, Time12

For your nearest Home
Entertainment Dealer or
Authorized Servicenter
call toll-free in the U.S.A.

1-800-336-1900

Canadian Consumers ☺
Your toll free numbers are:

English: 1-800-522-0338

French: 1-800-522-0445

If you would like a copy of this manual in French, please follow the
instructions below:

Si un livret d'instructions en fran•ais n'est pas inclus avec votre
appareil, vous pouvez en obtenir un (indiquer le numŽro de mod•le,
votre nom, et votre adresse) en vous adressant ˆ:

Thomson Consumer Electronics
Attention: Canadian Operations
P.O. Box 0944
Indianapolis, IN 46206-0944

If your VCR needs service, please contact your dealer or the nearest
Servicenter from the yellow pages. Please do not send any products to
the Indianapolis address listed in this manual or on the carton. This
will only add delays in service for your product.

 **THOMSON CONSUMER ELECTRONICS**
10330 North Meridian Street
Indianapolis, IN 46290-1024

©1996 Thomson Consumer Electronics, Inc.

Trademark(s) Registered

Marca(s) Registrada(s)

Printed in Japan

Part Number 96-VR730HF-1

VQTS3235 (A)

Free Manuals Download Website

<http://myh66.com>

<http://usermanuals.us>

<http://www.somanuals.com>

<http://www.4manuals.cc>

<http://www.manual-lib.com>

<http://www.404manual.com>

<http://www.luxmanual.com>

<http://aubethermostatmanual.com>

Golf course search by state

<http://golfingnear.com>

Email search by domain

<http://emailbydomain.com>

Auto manuals search

<http://auto.somanuals.com>

TV manuals search

<http://tv.somanuals.com>