

RCA

TV/DVD/Radio User's Manual

Changing Entertainment. Again.



Important Information

CAUTION

RISK OF ELECTRIC SHOCK
DO NOT OPEN

Caution: To reduce the risk of electric shock, do not remove cover (or back). No user serviceable parts inside. Refer servicing to qualified service personnel.



This symbol indicates "dangerous voltage" inside the product that presents a risk of electric shock or personal injury.



This symbol indicates important instructions accompanying the product.

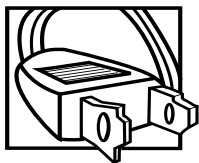

Caution: To prevent electric shock, match wide blade of plug to wide slot, fully insert.

Attention: Pour éviter les chocs électriques, introduire la lame la plus large de la fiche dans la borne correspondante de la prise et pousser jusqu'au fond.

Refer to the identification/rating label located on the back panel of your product for its proper operating voltage.

FCC Regulations state that unauthorized changes or modifications to this equipment may void the user's authority to operate it.

Cable TV Installer: This reminder is provided to call your attention to Article 820-40 of the National Electrical Code (Section 54 of the Canadian Electrical Code, Part 1) which provides guidelines for proper grounding and, in particular, specifies that the cable ground shall be connected to the grounding system of the building as close to the point of cable entry as practical.

Product Registration

Please fill out the product registration card (packed separately) and return it immediately. Returning this card allows us to contact you if needed.

Product Information

Keep your sales receipt to obtain warranty parts and service and for proof of purchase. Attach it here and record the serial and model numbers in case you need them. The numbers are located on the product.

Model No. _____ Serial No. _____ Purchase Date: _____

Dealer/Address/Phone: _____

CAUTION

THIS PRODUCT UTILIZES A LASER. USE OF CONTROLS OR ADJUSTMENTS OR PERFORMANCE OF PROCEDURES OTHER THAN THOSE SPECIFIED HEREIN MAY RESULT IN HAZARDOUS RADIATION EXPOSURE. DO NOT OPEN COVERS AND DO NOT REPAIR YOURSELF. REFER SERVICING TO QUALIFIED PERSONNEL.

WARNING

To reduce the risk of fire or electric shock, do not expose this product to rain or moisture.

**CLASS 1
LASER
PRODUCT**

Chapter 1: Connections and Setup

Under Cabinet Mounting Instructions	4
Before Mounting	4
Tools Required	4
Parts Packed with Your Unit	4
Mounting Procedure	4
Jacks on the Back of the TV/DVD/Radio (listed from left to right)	5
Buttons on the Bottom of the TV/DVD/Radio (listed from left to right)	6
Buttons and Controls on the Front of the TV/DVD/Radio	7
Install the Battery in the Remote	9
The Remote Control (buttons listed in alphabetical order)	9
TV Setup	10
Set the Time	10
Choose Your Signal	11
Complete Auto Channel Search	11
Adding or Removing Channels	11
Picture Quality	12
DVD Basics	12
Regional Coding	12
Using Different Menus	13
Types of Discs Your DVD Will Play	13
Loading and Playing Discs	14
Using a Disc Menu	15

Chapter 2: Playing Discs and Using the Radio

Using the On-Screen Info Display	18
Playing DVDs	18
Selecting a Title	19
Selecting a Chapter	19
Time Display	20
Changing the Audio Language	20
Turning QSurround™ On/Off	21
Selecting the Subtitle Language	21
Turning the Subtitles ON/OFF	22

Table of Contents

Changing the Camera Angle (DVDs)	22
Using the Repeat Feature	23
Using Bookmarks	24
Playing Audio CDs	25
Selecting a Track	25
Time Display	26
Selecting a Play Mode	26
Using the Repeat Feature	28
Using the A-B Repeat Feature	29
Using Bookmarks	30
Playing MP3 Discs	31
Selecting a Folder	31
Selecting a Song	31
Using the Repeat Feature	32
Playback Features	33
Fast Motion Playback (Picture Scan)	33
Skipping Tracks or Songs	33
Using the Radio	34
Tuning a Station	34
Storing a Station	34
 Chapter 3: Using the DVD's Menu System	
The DVD's Menu System	36
Moving through the Menus	36
Language Menu	37
VIDEO Menu	38
Rating Menu	39
 Chapter 4: Other	
Troubleshooting	42
Limited Warranty	45
Accessory Order Form	49
Index	51

Connections & Setup

Chapter Overview:

- Under Cabinet Mounting Instructions
- Jacks on the Back of the TV/DVD/Radio
- Buttons on the Bottom of the TV/DVD/Radio
- Buttons and Controls on the Front of the TV/DVD/Radio
- Install the Battery in the Remote
- The Remote Control
- TV Setup
- DVD Basics

Changing Entertainment. Again.



Connections & Setup

Under Cabinet Mounting Instructions

Before Mounting

- Empty contents from the selected cabinet where the unit will be mounted.
- Clean the underside of the cabinet.

Note: We recommend the unit be mounted towards the front edge of the cabinet.

Tools Required

- Drill and Drill Bit
- Ruler or Tape Measure
- Masking Tape
- Nail or Awl
- Scissors
- Safety Glasses
- Phillips Screwdriver
- Countersink (Optional)

Parts Packed with Your Unit

Screws: 4 - 2 1/2 inches Phillips head screws
4 - 1 3/4 inches Phillips head screws
4 - 1 inch Phillips head screws



Spacers: 4 - 3/4 inches
4 - 1/2 inches
4 - 1/4 inches



Washers: 4 

Template: 

Cord Hooks: 2 

Mounting Procedure

1. Position the template (a separate foldup sheet) in the desired location.
2. Use the tape to hold the template in position.
3. Drill four 4.5 mm (3/16") holes at the locations shown.
4. Remove the paper template.
5. Attach the unit using four screws and spacers as required to adjust to the desired height.

Once you have attached your unit to the cabinet, you can use the supplied cord hooks to store excess cord.

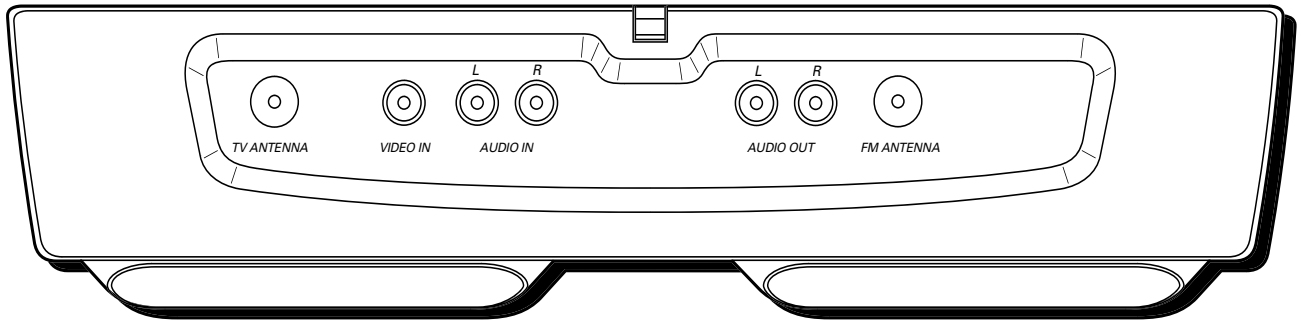

Jacks on the Back of the TV/DVD/Radio (listed from left to right)

TV ANTENNA Connect the coaxial cable from your cable or antenna to this jack.

VIDEO IN Receives video input signals from another component such as a VCR or camcorder, including some security cameras.

L/R AUDIO IN Receives audio input signals from another component such as a VCR, camcorder, or Internet access device.

L/R AUDIO OUT Sends audio input signals from the unit to another component such as a receiver or amplifier, or outputs the sound to powered (amplified) speakers.

FM ANTENNA Connect an FM radio antenna to improve radio reception.

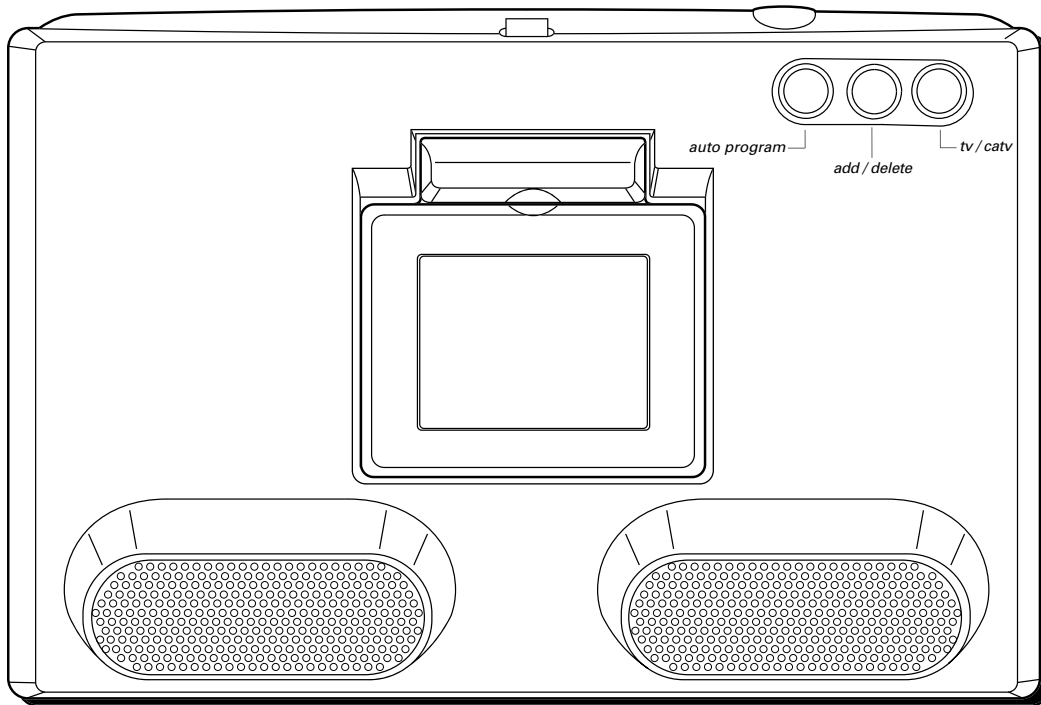

Buttons on the Bottom of the TV/DVD/Radio

(listed from left to right)

AUTO PROGRAM Press this button to begin auto channel search.

ADD/DELETE Press this button to either add or delete a station from your TV after you have completed the auto channel search.

TV/CATV Press this button once if you have an antenna connected to your unit; press again if you have cable or a cable box connected to your unit.

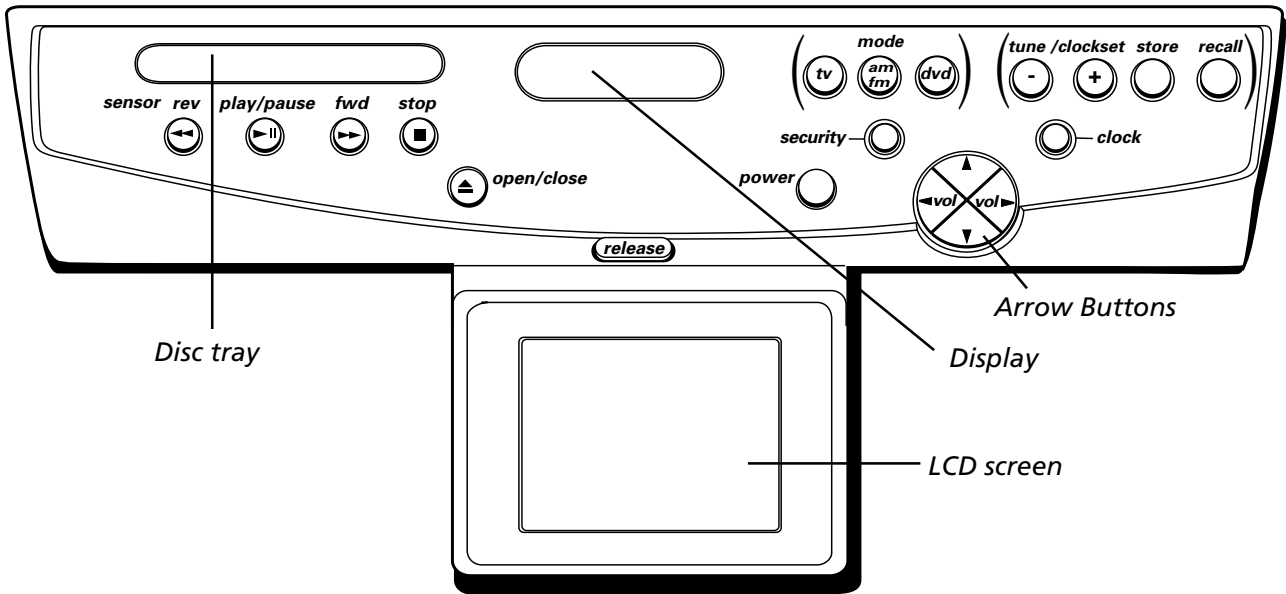

Buttons and Controls on the Front of the TV/DVD/Radio

Disc Tray Insert DVDs or CDs in this tray.

Display The time and/or radio stations appear in this display.

LCD Screen Video appears here (when watching TV or a DVD). The TV turns off automatically when you close the LCD screen.

Important: In order to conserve the LCD screen life, make sure the TV is turned off. Don't use the LCD screen as a light because continual operation will reduce the life of the unit significantly.

Buttons (listed alphabetically)

Arrow (up and down) buttons When in TV mode, scans up or down through the current channel list. Press once to change the channel up or down; press and hold to continue changing channels.

Continued on next page

Connections & Setup

AM/FM MODE Switches between FM and AM radio.

CLOCK Press this button and TUNE/CLOCK SET +/- simultaneously to set or change the time. Press and hold to scan quickly.

DVD MODE Puts the TV/DVD/Radio in the DVD mode in order to play a DVD, an audio CD, or MP3 disc.

FWD (▶▶) Scans forward on a disc (DVD, CD, or MP3).

OPEN/CLOSE (▲) Opens and closes the disc tray. TV/DVD/Radio must be in DVD mode before tray will open.

PLAY/PAUSE (▶||) Switches between play and pause when you're playing a disc (DVD, CD, or MP3).

POWER Turns the TV/DVD/Radio on or off.

RECALL In radio mode, cycles through the preset radio stations.

RELEASE Releases the LCD screen. You can then adjust the screen by moving it up/down and rotating it left or right carefully.

REV (◀◀) Scans backward on a disc (DVD, CD, or MP3).

SECURITY In any mode, press this button to select the video channel for the source connected to the video input jacks on the back of the TV/DVD/Radio.

SENSOR Receives a signal from the remote control.

STOP (■) Stops disc play.

STORE Press this button to display the preset numbers for storing radio stations into memory. You can store up to 10 radio stations in AM and FM memory.

TUNE +/- (up and down) buttons In radio mode, scans up and/or down through the radio channels. Also, used with the CLOCK button to set the time. Use these buttons when you want to skip a track or song when playing a CD or MP3 disc.

TV MODE Press this button to display the TV signal.

VOL +/- (up and down) buttons Increase or decrease the sound from the built-in speakers.

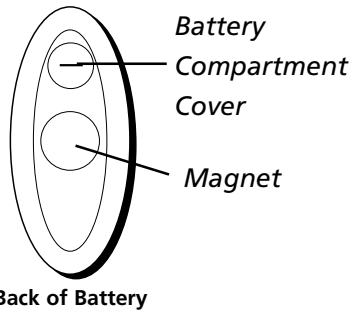

Install the Battery in the Remote

1. Use a coin to remove the battery compartment cover on the back of the remote.
2. Insert the lithium battery (type CR2025).
3. Put the battery compartment cover back on the remote.

Note: When the remote control isn't in use, the magnet on the back of the remote attaches to the side of the unit opposite the DVD player for easy storage.

The Remote Control (buttons listed in alphabetical order)

0-9 and 100 (Number buttons) In TV mode, enter channel numbers directly through the remote control. To enter a number above 99, for example 113, press 100, then 1, and then 3.

Arrow (up, down, left, right) buttons Move through the options on the on-screen Info Display and DVD menu system.

AM/FM Switches between FM and AM radio.

DISC MENU In DVD mode, displays the disc's menu if available.

DVD Puts the remote in DVD mode, allowing you to play a disc (DVD, CD, or MP3).

DVD MENU In DVD mode, displays the DVD's menu system when a disc is not playing (stop mode).

ENTER When you're using the arrow buttons to choose an option on the LCD Info Display, press ENTER to select the item.

MUTE Lowers the volume to its minimum level. Press again to restore volume.

PIX (Picture) Displays the picture screen, allowing you to adjust Contrast, Brightness, Color, and Tint Level.

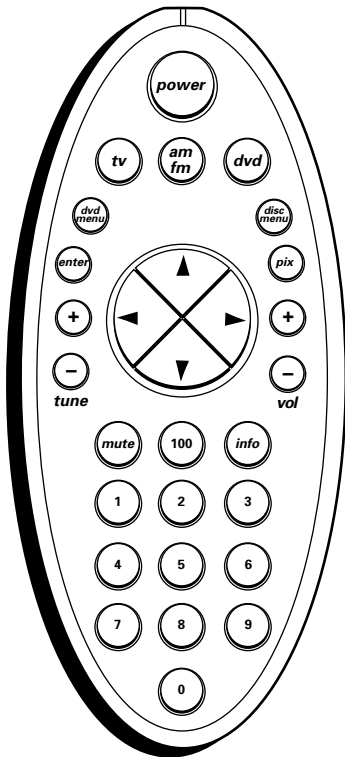

Continued on next page

Connections & Setup

POWER Turns on and off the unit.

INFO Press this button to access the DVD, CD, or MP3 Info Displays.

TUNE +/- (up and down) buttons In TV mode, scans through the channel list. In radio mode, tunes to a frequency (radio station). In DVD mode, skips forward/backward in disc chapters or tracks. Each press changes the channel, station, or track; press and hold to scan.

TV Puts the remote control in the TV mode.

VOL +/- (up and down) buttons Decrease or increase the volume.

TV Setup

You can connect the TV/DVD/Radio to a cable TV system, dipole antenna, or outside antenna using the TV ANTENNA jack. Once you've connected the TV signal, plug the end of the power cord into the wall outlet. Match the wide blade of the plug with the wide slot in the outlet. Insert the plug completely into the outlet. Now you're ready to set the time, choose your signal, and program the channel list.

Set the Time

When you first plug in the TV/DVD/Radio, the clock flashes until you set it. The TV/DVD/Radio doesn't have to be turned ON to set the clock. To set the clock:

1. Turn on the TV/DVD/Radio using the POWER button.
2. Press and hold the CLOCK button and TUNE/CLOCK SET - / + button at the same time (both buttons are on the front of the TV/DVD/Radio).
3. Press the - button to decrease and the + button to increase the time. Press and hold the buttons to scan quickly.

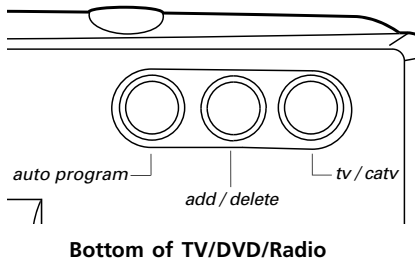

Choose Your Signal

1. Press the TV button to place the TV/DVD/Radio in the TV mode.
2. Locate the TV/CATV button on the underside of your unit.
3. If you have a dipole antenna connected to your TV, press the TV/CATV button (*TV* appears to the left of the channel number on the LCD screen). If you're using cable or a cable box, press the TV/CATV button until the correct signal type appears: *STD* for standard cable or *HRC* or *IRC* for certain cable systems.

Note: STD is the most common cable type in the U.S. If you don't know what type of cable system you have, contact your cable company.



Complete Auto Channel Search

1. Locate the TV AUTO PROGRAM button on the underside of your unit.
2. Press TV AUTO PROGRAM (the TV automatically starts searching the channels). When the TV finds an active channel, it places it in the channel list.

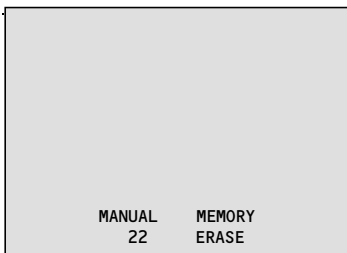

Adding or Removing Channels

You might want to add or remove channels if some of them are not active, have weak signals, or you do not want them in your channel memory. You can still tune to a channel after you remove it from the channel list—use the number buttons on the remote.

1. If your TV isn't on, press the TV button.
2. Tune to the channel you want to delete by using the TUNE + or - button on the remote or up/down button on the front of the unit. To tune to a channel you want to add, enter the number using the number buttons on the remote control.

Continued on next page

Connections & Setup

3. Press the ADD/DELETE button on the underside of your unit to add or delete (erase) the channel.
4. Wait until the display disappears from the screen each time you delete or add a channel.

Note: If you don't wait until the display disappears before you change channels, the add/delete function will be disabled. You must Auto Channel Search again to reactivate the add/delete function.

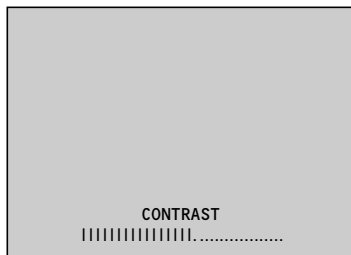

Each time you press the PIX button on the remote, one of the picture quality options appears. To adjust, press the VOL up/down.

Picture Quality

The picture quality options let you adjust the way the picture looks. Adjust the picture quality with the PIX button on the remote control.

Contrast Adjusts the difference between the light and dark areas of the picture.

Brightness Adjusts the brightness of the picture.

Color Adjusts the richness of the color.

Tint Adjusts the balance between the red and green levels.

1. Press the PIX button repeatedly to cycle through the options.
2. Press the VOL +/- buttons to adjust the option.

DVD Basics

To get the optimum use out of the DVD section of the TV/DVD/Radio, make sure you read this section of the chapter.

Regional Coding

Both the DVD player and the discs are coded by region. These regional codes must match in order for the disc to play. If the codes don't match, the disc won't play. This unit's code is region 1. Other regional codes can't be played in this unit.

Using Different Menus

Each disc is programmed with different features. There are three paths that you can use to access features: the disc's menu, the DVD's Info Display, and the DVD's Menu System. Remember that a feature only works if the disc was programmed with that feature. For example, if you choose subtitles, the subtitles only appear if the disc was created with subtitles.

- **The Disc menu** – The disc menu is part of each disc and is separate from the DVD's Info Display and DVD's Menu System. The contents of each disc's menu vary according to how the disc was authored and what features are included. The disc menu is turned on when a disc is inserted or you press the PLAY button on the remote.
- **The DVD's Info Display** – The Info Display appears as icons across the top of the screen when a disc is playing. It can only be accessed while you are playing a disc. It's turned on and off with the INFO button on the remote. The Info Display is explained in Chapter 2.
- **The DVD's Menu System** – The DVD's Menu System is accessed only when a DVD is in the stop mode. The DVD's menu system is explained in Chapter 3.

Types of Discs Your DVD Will Play

- DVD discs – DVDs contain video.
- Audio discs – Audio CDs contain musical or sound content only.
- MP3 discs – A disc that contains audio files (for example, a CD-R with downloaded MP3 files).



Loading and Playing Discs

Before you load a disc, make sure that it is compatible with the player. Note that the following discs CANNOT be used with this player:

- Laserdisc
- CD-I, CD-ROM, CD-RW, DVD-ROM
- MiniDisc
- CD-G discs play audio only, not graphics



This is an example of a one-sided disc.

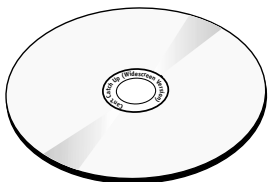

This is an example of a 2-sided disc. The title is in the center.

To Load and Play a Disc

To put the TV/DVD/Radio in DVD mode and play a disc, press the DVD MODE button on the TV/DVD/Radio or DVD on the remote control.

Note: You must be in the DVD mode to open the disc tray.

1. Press the OPEN/CLOSE button on the front of the TV/DVD/Radio. The disc tray opens.
2. Place a disc gently into the tray with the disc's label facing up (double-sided discs have content on both sides, so you can place either side up).
3. Press the OPEN/CLOSE button. The disc tray closes.

Note: Pressing the PLAY/PAUSE button also closes the tray and starts the disc playing.

The TV/DVD/Radio reads the disc's table of contents, and then one of following happens depending on how the disc was programmed:

- No disc menu appears.
- The disc menu appears.
- The disc menu appears on the screen when you press PLAY/PAUSE on the front of the TV/DVD/Radio or DISC MENU on the remote control.

When you stop playing a disc, the TV/DVD/Radio remembers where you stopped. When you start playing the disc again, it picks up where you left off unless the disc is removed, power is turned off, or the unit is unplugged.

A screen saver image might be displayed on the screen if you leave a disc in play, pause, or stop mode for approximately three minutes. To make the screen disappear, press PLAY or DVD button.

Using a Disc Menu

A disc is capable of having an on-screen menu that is separate from the DVD's on-screen Info Display and the DVD's Menu System. The disc menu might only contain a list of the titles and chapters, or it may allow you to change features such as language and playback settings.

Although the content and operation of disc menus vary from disc to disc, the following example will give you an idea of what to expect.

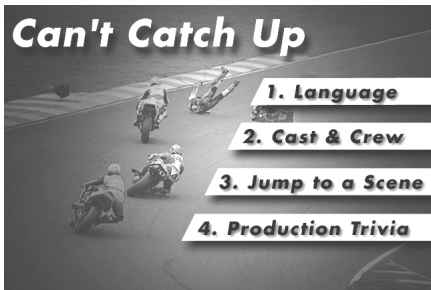

This is an example of a disc menu. The menus on discs vary because the disc menu is created by the disc's author.

1. When the disc is first inserted and/or you press PLAY/PAUSE on the front of the TV/DVD/Radio or DISC MENU on the remote control, the disc menu appears.

Continued on next page

Connections & Setup

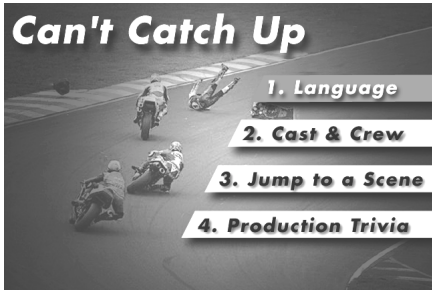

2. Make sure the remote is in the DVD mode, and press the up/down arrow buttons on the remote to highlight the section of the disc menu you want to choose, and press ENTER on the remote. In the example on the left, *Language* has been selected.



3. Press the up/down arrow buttons to select a language, and press ENTER on the remote.
4. Press PLAY/PAUSE on the TV/DVD/Radio, or DVD or DISC MENU on the remote to play the disc.

In this example, *English* is highlighted. Press ENTER on the remote to play the disc with English dialog.

Playing Discs and Using the Radio

Chapter Overview

- Using the On-Screen Info Display
- Playing DVDs
- Playing Audio CDs
- Playing MP3 Discs
- Playback Features
- Using the Radio

Changing Entertainment. Again.



Playing Discs and Using the Radio

Using the On-Screen Info Display

The on-screen Info Display contains many playback features. To see the Info Display, use the INFO button on the remote while a disc is playing.

Each feature of the Info Display is illustrated with an icon. Use the left/right arrow buttons on the remote or TV/DVD/Radio to move through the different icons in the Info Display. When an icon is highlighted, use the up/down arrow buttons on the remote to scroll through the choices displayed in the text box under the icons.

Remember, you can only access the Info Display when you're playing a disc. Also, the Info Display features are only available if the disc was created with that particular feature (i.e., if you select the Subtitle icon, you won't be able to change the subtitle language unless the author of the disc created the disc with different subtitle languages).

The invalid symbol  appears on the screen when you press a button that doesn't have any function. To make the Info Display disappear from the screen, press INFO on the remote until it disappears.

Playing DVDs

For basic information about loading and playing discs, go to page 14. Press the INFO button on the remote to toggle through the Info Display.

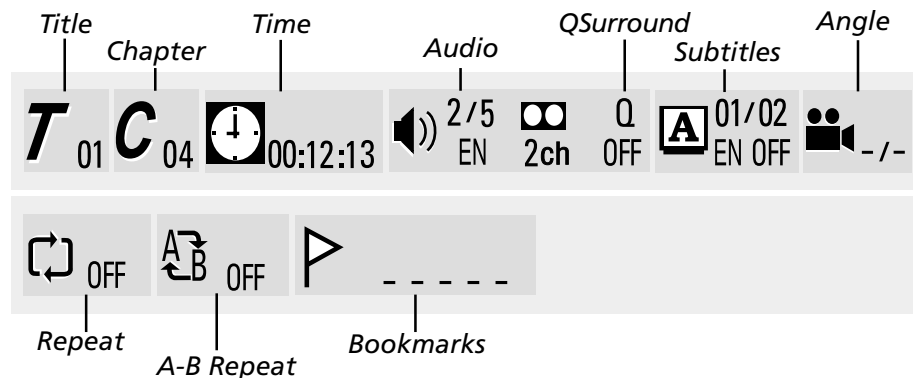

T 01

Selecting a Title

Some discs contain more than one title. For example, there might be four movies on a disc (each movie might be considered a title). Each title is divided into chapters. To select a title:

1. While the disc is playing, press INFO on the remote (the Info Display appears).
2. If the *Title* icon on the Info Display isn't highlighted, use the left/right arrow buttons to highlight it.
3. Use the number button(s) on the remote to enter the title number or press the up/down arrow buttons to go to the next or previous title.
4. Press ENTER on the remote to go to a title.

Notes:

To make the Info Display disappear, press the INFO button twice on the remote.
Some discs only have one title.

C 04

Selecting a Chapter

Because DVD discs use digital technology, a title can be divided into individual chapters (similar to tracks on a CD). You can skip to a specific chapter by using the Chapter feature in the Info Display.

1. While a disc is playing, press INFO on the remote (the Info Display appears).
2. Press the left/right arrow buttons to highlight the *Chapter* icon.
3. Use the number buttons on the remote to enter the number of the chapter you want to play or press the up/down arrow buttons to go to the next or previous chapter.
4. Press ENTER on the remote to go to that chapter.

Notes:

To make the Info Display disappear, press the INFO button twice on the remote.
The Chapter feature only works on discs formatted with separate chapters.

Tip

You can also advance to the next chapter by pressing TUNE +, or go to the preceding chapter by pressing TUNE - on the remote.

Playing Discs and Using the Radio



Time Display

This feature displays the time for the current title and can act as a Time Search feature. You can go to a particular scene in a movie by entering the time that scene is played. Of course, when playing a disc, you must note the time of the scene. For example, if you like the dogfight scene in *Top Gun*, you can enter the elapsed time the scene plays and skip right to it. To use this feature:

1. While a disc is playing, press INFO on the remote to bring up the Info Display.
2. Press the left/right arrow buttons to highlight the *Time* icon.
3. Use the number buttons on the remote to enter the time of the scene location.
4. Press ENTER on the remote and the disc will go to that scene.



Changing the Audio Language

If the disc was created in different languages, you can use the Info Display to temporarily change the DVD player's Audio Language setting. Also, the audio format of the disc is fixed.

1. While a disc is playing, press INFO on the remote to bring up the Info Display.
2. Press the left/right arrow buttons to highlight the *Audio* icon.
3. Press the up/down arrow buttons to scroll through the audio languages (1/2 EN or 2/2 FR) that are available on the disc until the language you want appears in display.
4. Press ENTER to enter the language you chose.

Notes:

To make the Info Display disappear, press the INFO button twice on the remote.

The audio feature only works if the disc was created with multiple languages.

Some discs allow you to change the audio format from the disc's menu, if available.

Q OFF

Turning QSurround™ On/Off

You can use this feature to add a surround sound effect to the audio. This system allows conventional two-channel stereo to be rendered in correct perspective through the creation of “phantom” surround. The algorithms used have met the certification requirements of Dolby Laboratories Licensing Corporation for both Dolby Digital® and Pro Logic processes.

1. While a disc is playing, press INFO on the remote to bring up the Info Display.
2. Press the left/right arrow buttons to highlight the *Q* icon.
3. Press the up/down arrow buttons to the feature ON or OFF.
4. To make the Info Display disappear, press the INFO button twice on the remote.

A 01/02 EN OFF

01/02 EN is for English and 02/02 is for a second language.

Selecting the Subtitle Language

You can change the Subtitle Language of the disc, but only if the disc was created with subtitles.

1. While the disc is playing, press INFO on the remote.
2. Press the left/right arrow buttons to highlight the *Subtitle* icon.
3. Use the up/down arrow buttons to scroll through the subtitle languages that are available on the disc. The language currently showing in the icon is the active selection. The subtitles will be shown in that language.

Notes:

To make the Info Display disappear, press the INFO button twice on the remote.

Changing the subtitle language with the Info Display only affects the disc currently being played. When the disc is removed or the player is turned off, the subtitle language reverts to the default language.

QSURROUND™ is a trademark of QSound Labs, Inc.

Manufactured under license from Dolby Laboratories. “Dolby” and the double-D symbol are trademarks of Dolby Laboratories. Confidential unpublished works ©1992-1997 Dolby Laboratories, Inc. All rights reserved.

Playing Discs and Using the Radio



Change OFF to ON to see subtitles in the language you selected.

Turning the Subtitles ON/OFF

By default, subtitles are OFF. To turn subtitles ON:

1. While the disc is playing, press INFO on the remote.
2. Highlight the *Subtitle* icon.
3. Press the left/right arrow buttons to highlight OFF.
4. Press the up/down arrow buttons on the remote to turn subtitles ON. When subtitles are on, the subtitles appear on the TV screen.

Notes:

To make the Info Display disappear, press the INFO button twice on the remote.

When the disc is removed or the player is turned off, subtitles default is set to OFF.

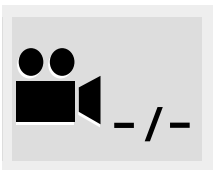

Changing the Camera Angle (DVDs)

Some discs contain multiple angles of a particular scene or sequence. If the disc only has one angle (-/-), this feature won't work. To change the camera angle:

1. While a disc is playing, press INFO on the remote. The Info Display appears.
2. Use the left/right arrow buttons to highlight the camera *Angle* icon.
3. Use the up/down buttons to scroll through the camera angle choices, if available. For example, if there are 3 different angles, the icon will read 1/3. This means angle 1 is currently being displayed.

Note: To make the Info Display disappear, press the INFO button twice on the remote.

Playing Discs and Using the Radio



Using the Repeat Feature

The default mode for the Repeat feature is OFF. There are three Repeat options:

- DISC – repeats the disc that is playing
- TITLE – repeats the title that is playing
- CHPT – repeats the chapter that is playing

To Use Repeat:

1. While a disc is playing, press INFO twice on the remote to bring up the Info Display.
2. Highlight the *Repeat* icon if it's not already highlighted (*OFF* appears in the icon box).
3. Press the up/down arrow buttons to scroll through the *Repeat* options (*DISC*, *TITLE*, *CHPT*, *OFF*) until the Repeat option you want appears in the icon box.
4. Press ENTER on the remote. The selected repeat option loops repeatedly until you turn Repeat off. Repeat is turned off by completing steps 1 through 3 above, and selecting the *OFF* option.

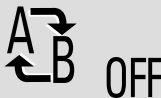

Using the A-B Repeat Feature

A-B Repeat lets you define a specific segment on the disc that you want to repeat. For example, you might like to watch the dogfight in the movie *Top Gun*. To watch this scene over and over:

1. Find the spot on the disc that is a few seconds **before** the beginning of the scene you want to repeat (this gives you time to access the Info Display and the Repeat feature).
2. Press INFO twice and highlight the *A-B* Repeat icon with left/right arrow buttons.
3. Press the up/down arrow buttons or ENTER button on the remote control until the *A-* appears at the beginning of the scene you want to repeat. This sets the start point of the scene.
4. When you get to the part of the disc that you want to be the end of the repeated segment (the *B* point), press the up/down arrow buttons or ENTER button on the remote control. This sets the end point (*B* appears). The segment repeats until you turn *Repeat* off.
5. To make the Info Display disappear from the screen, press the INFO button.

Playing Discs and Using the Radio

How to Cancel the Repeat Features

There are three ways to cancel Repeat:

- Press STOP.
- Select OFF in the icon.
- Eject the disc.



Using Bookmarks

The bookmark feature lets you mark a point on the disc that you can go to quickly. You can store up to 5 bookmarks per disc. When you turn the TV/DVD/Radio off or remove the disc, bookmarks are cleared.

Storing a Bookmark

1. While a disc is playing, press INFO twice on the remote.
2. Highlight the *Bookmark* icon.
3. Use the number buttons (1-5) to select the bookmark.
4. When you reach the scene you want to mark, press ENTER.
5. Press the INFO button on the remote to make the Info Display disappear from the screen.



Using a Bookmark

To use the bookmark feature, it must be displayed on the TV screen. To access a stored bookmark:

1. While you're playing a disc, press INFO twice on the remote. The Info Display appears.
2. Highlight the *Bookmark* icon.
3. Press the number of the bookmark. The player advances the disc to the point that you selected.
4. To make the Info Display disappear from the screen, press INFO on the remote.

Playing Discs and Using the Radio

Clearing a Bookmark

The bookmarks are cleared each time a disc is removed from the disc tray or when the power is turned off.

Playing Audio CDs

For basic information about loading and playing discs, go to page 14. When playing an audio CD, press the INFO button on the remote (the audio CD Info Display appears as shown below). Some of the audio CD playback features work the same as the DVD playback features.

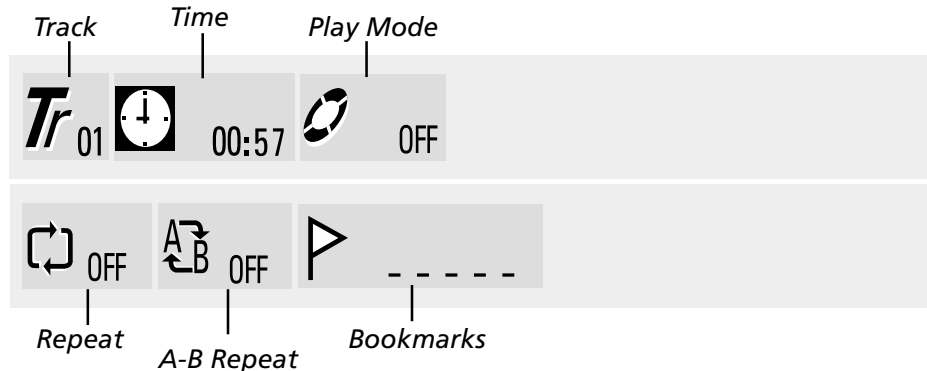

Selecting a Track

Audio discs contain several tracks. To select a Track:

1. While the disc is playing, press INFO on the remote to bring up the Info Display.
2. If the *Track* icon on the Info Display isn't highlighted, use the left/right arrow buttons to highlight it.

Continued on next page

Playing Discs and Using the Radio

3. Use the number button(s) on the remote to enter the track number or press the up/down arrow buttons to go to the next or previous track.
4. Press ENTER on the remote when the track you want to play appears in the icon.

Note: To make the Info Display disappear, press the INFO button twice on the remote.



00:57

Time Display

This feature displays the audio time for the disc and can act as a Time Search feature. You can go to a particular track on the disc by entering the time of the track. To use this feature:

1. While a disc is playing, press INFO on the remote to bring up the Info Display.
2. Press the left/right arrow buttons to highlight the *Time* icon.
3. Use the number buttons on the remote to enter the time of the track location.
4. Press ENTER on the remote and the disc goes to that track.



OFF

Selecting a Play Mode

You can choose what order the tracks will play on a disc. The standard play mode is the default. There are three play mode options:

- *OFF* (Standard Play): plays the disc's tracks in their default order.
- *RND* (Random Play): plays the tracks in random order.
- *PROG* (Program Play): plays the tracks on the disc in the order you have programmed (you must create a play list to set the order you want the tracks on the disc to play).

Random Play

The *RND* icon appears in the upper left corner of the TV screen to let you know that you are in Random Play.

1. While a disc is playing, press INFO on the remote to bring up the Info Display.
2. Press the left/right arrow buttons to highlight the *Play Mode* icon.

Playing Discs and Using the Radio

3. Press the up/down arrow buttons until *RND* (Random) appears in the icon.
4. Press ENTER on the remote to select the option.

Note: Press STOP on the TV/DVD/Radio or eject the disc to cancel Random Play.

Programmed Play

To use the programmed play option, you must create a playlist to set the order you want the tracks on the disc(s) to play.

Creating a Program List for an Audio CD

1. While a disc is playing, press INFO on the remote to bring up the Info Display.
2. Press the left/right arrow buttons to highlight the *Play Mode* icon.
3. Press the up/down arrow buttons until *PROG* (Program) appears in the icon box.

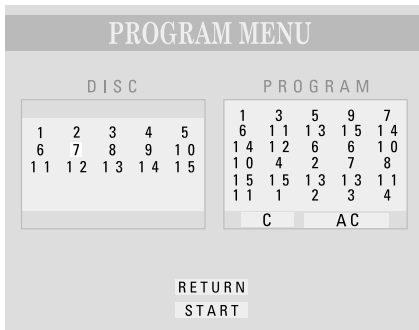

4. Press ENTER on the remote, and a *PROGRAM MENU* appears with two separate lists: *DISC* and *PROGRAM*.
5. Use the left/right/up/down arrow buttons to move through the two lists. Press ENTER once you've highlighted a disc track number to transfer it from the *DISC* list to the *PROGRAM* list.
6. Repeat steps 4 and 5 until you have the lineup that you want or the *PROGRAM* list is full.
7. Highlight START and press ENTER. The *PROG* icon appears in the upper left corner of the TV screen, and the songs begin to play in the order that you selected.

Note: Pressing RETURN in the *PROGRAM MENU*, returns to the original state. Any programmed tracks will remain unless you clear the list, eject the CD, or power off.

Continued on next page

Playing Discs and Using the Radio

Clearing Items from the Programmed List

You can clear the last selected track or the complete list after you start playing the programmed list.

1. While the disc is playing, press **STOP** on the front panel, then press **PLAY/PAUSE** to begin playing the disk so you can bring up the Info Display.
2. Press the **INFO** button.
3. Use the left/right arrow buttons to highlight the *Play Mode* icon.
4. Press the up/down arrow buttons until *PROG* (Program) appears.
5. Press **ENTER** on the remote to bring up the programmed list.
6. Use the left/right/up/down arrow buttons to highlight *C* or *AC*, and press **ENTER**.
 - *C* (CLEAR) clears the last programmed track.
 - *AC* (ALL CLEAR) clears all the tracks.
7. Use the left/right/up/down arrow and **ENTER** buttons to replace the last selected track or the lineup.

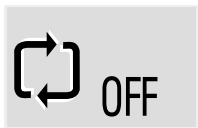

Using the Repeat Feature

The default mode for the Repeat feature is OFF. There are two Repeat options:

- **DISC** – repeats the disc that is playing
- **TRACK** – repeats the track that is playing

To Use Repeat:

1. While a disc is playing, press **INFO** twice on the remote to bring up the Info Display.
2. Highlight the *Repeat* icon if it's not already highlighted (*OFF* appears in the icon box).
3. Press the up/down arrow buttons to scroll through the *Repeat* options (*DISC*, *TRACK*, *OFF*) until the Repeat option you want is displayed in the text box.
4. Press **ENTER** on the remote. The selected repeat option loops repeatedly until you turn Repeat off. Repeat is turned off by completing steps 1 through 3 above, and selecting the *OFF* option.

Playing Discs and Using the Radio



Using the A-B Repeat Feature

A-B Repeat lets you define a specific segment on the disc that you want to repeat.

To Use A-B Repeat:

1. Find the spot on the disc that is a few seconds **before** the beginning of the location you want to repeat (this gives you time to access the Info Display and the Repeat feature).
2. Press INFO twice and highlight the *A-B* Repeat icon with left/right buttons.
3. Press the up/down arrow buttons or ENTER button on the remote until the *A-* appears at the beginning of the section of the track you want to repeat. This sets the start point.
4. When you get to the part of the disc that you want to be the end of the repeated section (the *B* point), press the up/down arrow buttons or ENTER button on the remote. This sets the end point (*B* appears). The section repeats until you turn *A-B Repeat* off.
5. To make the Info Display disappear from the screen, press the INFO button.

How to Cancel the Repeat Features

There are three ways to cancel Repeat:

- Press STOP.
- Select OFF in the icon.
- Eject the disc.

Playing Discs and Using the Radio

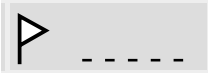

Using Bookmarks

The bookmark feature lets you mark a point on the disc that you can go to quickly. You can store up to 5 bookmarks per disc. When you turn the TV/DVD/Radio off or remove the disc, the bookmarks are cleared.

Storing a Bookmark

1. While a disc is playing, press INFO twice on the remote.
2. Highlight the *Bookmark* icon.
3. Use the number buttons (1-5) to select the bookmark.
4. When you reach the scene you want to mark, press ENTER.
5. Press the INFO button on the remote to make the Info Display disappear from the screen.

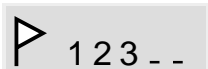

Using a Bookmark

To use the bookmark feature, it must be displayed on the TV screen. To access a stored bookmark:

1. While you're playing a disc, press INFO twice on the remote. The Info Display appears.
2. Highlight the *Bookmark* icon.
3. Press the number of the bookmark. The player advances the disc to the point that you selected.
4. To make the Info Display disappear from the screen, press INFO on the remote.

Clearing a Bookmark

The bookmarks are cleared each time a disc is removed from the disc tray or when the power is turned off.

Playing MP3 Discs

MP3 is a format for storing digital audio. An audio CD-quality song can be compressed into the MP3 format with very little loss of quality, while taking up much less space. CD-R discs that have been encoded in MP3 format can be played on your TV/DVD/Radio. For basic information about loading and playing discs, go to page 14.

When an MP3 disc is inserted into the disc tray, an *MP3 PLAYER* menu appears. The menu contains a Directory Tree with folders and individual songs. The MP3 PLAYER menu turns into a screen saver if it remains on the screen for approximately three minutes. To reactivate the menu, press the INFO display button on the remote

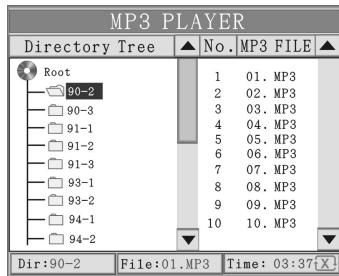

Selecting a Folder

Because MP3 discs contain a large number of songs, these songs are divided into folders. To select a folder:

1. Insert an MP3 disc into disc tray, the *MP3 PLAYER* menu appears.
2. Highlight a folder in the *Directory Tree* using the up/down arrows.
3. Press ENTER; the songs within that folder appear to the right and begin playing.

Note: The folder feature only works on discs formatted with separate folders.

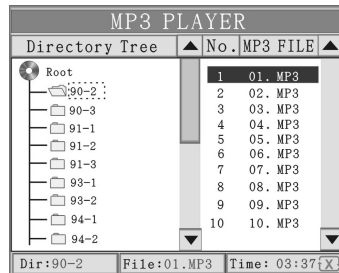

Selecting a Song

1. Insert an MP3 disc into disc tray, the *MP3 PLAYER* menu appears.
2. Highlight a folder in the *Directory Tree* using the up/down arrows.
3. Press the right arrow to move highlight bar to the song list and down arrow to highlight the song you want to play.
4. Press ENTER; the song begins playback.

Playing Discs and Using the Radio

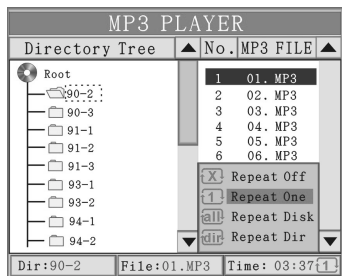

Using the Repeat Feature

The default mode for the Repeat feature is OFF. There are four Repeat options:

- *Repeat Off* – unit is automatically set to this option
- *Repeat One* – repeats the song that you select to play
- *Repeat Disk* – repeats all the songs on the disc
- *Repeat Dir* – repeats songs of the selected folder

To Use Repeat:

1. Insert an MP3 disk into disc tray, the *MP3 PLAYER* menu appears.
2. Highlight the folder or a song.
3. Press the right arrow twice to display the Repeat menu.
4. Highlight one of the *Repeat* options.
5. Press ENTER on the remote. The selected repeat option loops repeatedly until you turn Repeat off.

To Turn Off Repeat:

- Repeat steps 1-3 until Repeat Off is selected.
- Press the STOP button on front panel.
- Eject the disc.

Playback Features

Playback operations of DVDs and CDs vary among discs. Since this unit plays DVDs according to the disc contents the software producers designed, some playback features may not be available. Refer to the instructions packed with the DVDs for information.



Playback features aren't usually available during the opening credits of a movie. If a playback feature isn't available, the invalid symbol  appears on the screen when you press a button.

Fast Motion Playback (Picture Scan)

To scan quickly through the disc when you're playing it, use the Picture Scan feature.

1. Press the REV or FWD button on the TV/DVD/Radio when you're playing a disc.
2. Press the button again to scan at a faster speed. Each time you press the button, the scanning speed increases--2, 4, 8 times the normal speed.

Skipping Tracks or Songs

When a CD or MP3 disc is playing, use the TUNE + / - buttons on the remote control to skip a track or song. Press TUNE + to advance to the next track or song ( appears on the screen). Press TUNE - to go to the previous track or song ( appears on the screen).

Playing Discs and Using the Radio

Using the Radio

You can store up to 10 radio stations for the FM and AM frequencies.

1. Press the AM/FM MODE button to put the unit in the radio mode and to receive the FM radio signal. Press the button again to receive the AM radio signal.
2. Check the LCD display window to see which radio signal you selected.

Tuning a Station

The radio tunes to the last station it received. Press the TUNE + or – button to tune to the next available station. Press and hold to scan quickly through the stations.

Storing a Station

If you want to store a radio station in memory:

1. Select the AM or FM station you want to set by using the TUNE + or – button.
2. Press the STORE button (*MEMO* flashes in the LCD display window).
3. Press RECALL to cycle through the preset numbers.
4. Press STORE once you have chosen the location where you want to save the station. This station will be saved until you reset the station.
5. Repeat steps 1 - 4 to store additional radio stations.
6. To access the stored stations, repeatedly press RECALL to cycle through the preset stations.

Using the DVD's Menu System

Chapter Overview:

- The DVD's Menu System
- Language Menu
- Video Menu
- Rating Menu

Changing Entertainment. Again.



Using the DVD's Menu System

The DVD's Menu System

The DVD's menu system is not the same as the disc contents menu. Some discs have their own menu system related to the information of the movie. The disc contents menu system was discussed earlier in Chapter 2.

The DVD's menu system lets you select different features for the disc. A disc must be in the stop mode before you can bring up the DVD's Menu System. Press DVD MENU on the remote to bring up the menu system. There are three features in the DVD's menu: Language, Video, and Rating.

Moving through the Menus

The left/right/up/down arrows and ENTER button are used to navigate through the DVD's menu system. Step-by-step instructions are explained for the *O.S.D* language menu and then you can use the same method to access other features in the menu. The buttons you use to move through the menu system are displayed at the bottom of the menu.

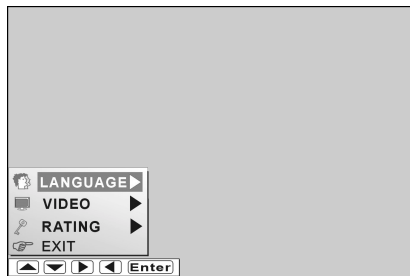

Setting the *O.S.D.* Language

1. Press DVD MENU on the remote to display the DVD's menu with the disc in the stop mode.

Using the DVD's Menu System

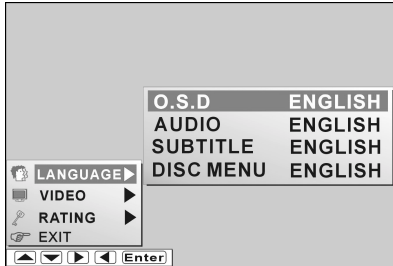

2. Press ENTER to select the *LANGUAGE* menu (use the up/down arrow to highlight another item in the menu, such as *RATING*).
3. Press ENTER to select the *O.S.D* menu as it is already highlighted.

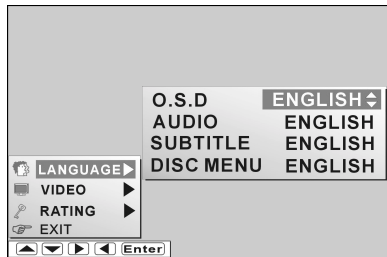

4. Use the up/down arrow to select a language (*ENGLISH*, *GERMAN*, *SPANISH*, *ITALIAN*, *FRENCH*) and then press ENTER to select it.
5. Press the left arrow to return to main menu.
6. Press the down arrow to highlight *EXIT* and then press ENTER to exit the menu.



Language Menu

The *LANGUAGE* menu enables you to choose *ENGLISH*, *GERMAN*, *SPANISH*, *ITALIAN* or *FRENCH* for the DVD's O.S.D (on-screen display) as well as the *AUDIO*, *SUBTITLE* and *DISC MENU* of the disc's contents. Use the same method for setting these languages as you did for the O.S.D. language. Use the left/right/up/down arrow and the ENTER buttons on the remote.

Using the DVD's Menu System

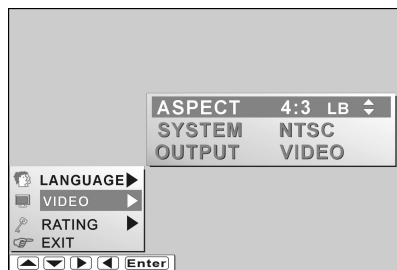

VIDEO Menu

The *VIDEO* menu enables you to choose the *ASPECT* ratio for your TV. This is also useful if you decide to connect a larger TV to this unit. Use the same method for moving through the menus as you did for the O.S.D. language.

The settings in the *SYSTEM* and *OUTPUT* options of the *VIDEO* menu are automatically programmed. You can't change them.

ASPECT Ratio

Choose one of three options that are available: *4:3 LB* (Letter Box), *4:3 PS* (Pan Scan), *16:9 WS* (Wide Screen).



4:3 LB (Letter Box): Choose this option if you want to see movies in their original aspect ratio (height-to-width ration). This option shows the entire wide screen film frame on a 4 x 3 screen by proportionately reducing the height of the wide screen image. Then its width fits the screen and fills in the top and bottom spaces with black bars.



4:3 PS (Pan Scan): Choose this option if you want the movie to fill the entire screen of your TV/DVD. This shows only the most important parts of the image and excludes the less important parts (the left and right edges).

Note: Most discs produced in a widescreen format can't be cropped in this fashion. This means the black bars appear at the top and the bottom of the screen.

Using the DVD's Menu System



16:9WS (Wide Screen): Select this mode when connecting to a widescreen TV. A wide screen picture is displayed full size.

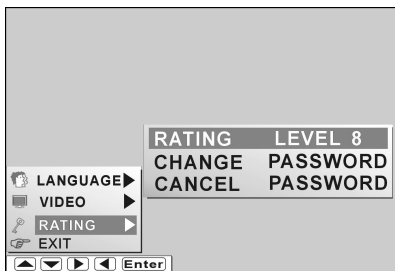

Rating Menu

The *RATING* menu lets you control the types of DVDs that your family watches. You decide which ratings require a password and which ones don't. The system ranks the ratings 1 through 8 in order to accommodate rating systems used in other countries. The three options of the *RATING* menu are: *RATING LEVEL*, *CHANGE PASSWORD*, and *CANCEL PASSWORD*. Use the same method for moving through the menus as you did for the O.S.D. language.

RATING LEVEL: Select the rating level that you want your family to watch. *LEVEL 1* (family) is considered least offensive and *LEVEL 8* (adult) is most offensive.

CHANGE PASSWORD: Select this option if you want to change your password.

CANCEL PASSWORD: Select this option if you want to cancel your password.

Notes: Make sure you remember your password (you might want to write down the number). The rating level is locked and cannot be changed unless you enter the correct password

If you forget your password, place remote in DVD mode by pressing the DVD button. Then press ENTER, TUNE-, and TUNE+ to reset password. The TV/DVD/Radio displays *RESET TO MANUFACTURE SETTING*. The display disappears after a few seconds and the screen goes blank. Press TV then DVD on the remote to return to DVD mode.

Continued on next page

Using the DVD's Menu System

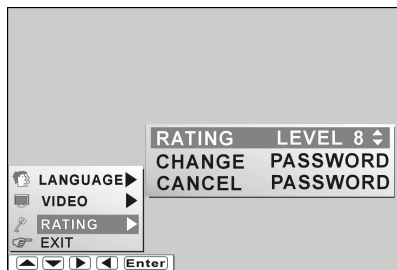

Setting the Rating Level

In this section, you will be setting the rating level as well as the password.

1. Press DVD MENU on the remote to bring up the menu.
2. Press the down arrow to highlight *RATING* and then press ENTER.
3. Press ENTER to change the rating (a screen to enter your password is displayed).
4. Enter a four-digit number using your remote control and press ENTER.
5. Use the up/down arrows to highlight the rating level and press ENTER.
6. Press the left arrow to return to main menu.
7. Press the down arrow to highlight *EXIT* and then press ENTER to exit the menu.

Note: If a rating level is blocked, you can still watch the material by entering your password. Just follow the on-screen information, and of course, know your password.

Other Information

Chapter Overview

- Troubleshooting
- Limited Warranty
- Accessory Order Form
- Index

Changing Entertainment. Again.



Troubleshooting

If you are experiencing product operation problems, please review the troubleshooting section before you call for service. Refer to the Limited Warranty for information on how to obtain repair service.

TV Problems

Won't turn on

- Try the POWER or TV MODE button on the front panel.
- Make sure all of the cables are firmly connected to the jacks.
- Make sure the unit is plugged in.
- Check antenna connections.
- Try unplugging the unit for a few minutes and then plugging it back in.
- If using the remote, make sure it is extremely close to the sensor on the front panel.

Blank screen

- Try another channel.
- Check picture quality adjustments. Go to page 12 for information about the picture quality options.
- Make sure the video line input isn't selected. Press SECURITY to switch between audio/video input jacks and the tuner.

No sound, picture okay

- Press VOL up button to increase the sound.
- Maybe sound is muted. Press the MUTE button to restore sound.

No picture, no sound but TV is on

- Press TV on remote to put remote in TV mode.
- The channel might be empty—change channels.

Poor TV reception

- Check antenna connections. Make sure all of the cables are firmly connected to the jacks.
- Maybe the cable/air setting is set to the wrong position. See page 11 for more information.
- Check picture quality settings. Go to page 12.

Add/delete function doesn't work

- Rerun Auto Channel Search again to reactivate the add/delete function. Remember to wait until the display disappears from the screen each time you add or delete a channel. Go to page 11 for more information

Radio Problems

Unit won't work

- Make sure you're TV/DVD/Radio is in the correct mode you want. Press the AM FM button on the remote or front panel to place the unit in the radio mode.
- Try unplugging the unit for a few minutes and then plugging it back in.

Poor radio reception

- Attach an FM antenna for better reception.

DVD Problems

Unit won't work

- Make sure you're TV/DVD/Radio is in the correct mode you want. Press the DVD button on the remote or front panel to place the unit in the DVD mode.
- Try unplugging the unit for a few minutes and then plugging it back in.

Disc won't play

- Insert a disc with the label side facing up.
- Check the type of disc you put into disc tray. This TV/DVD/Radio only plays digital video discs, audio CDs and MP3s. Go to page 13.
- Both the unit and the disc are coded by region. If the regional codes don't match, the disc can't be played. This TV/DVD/Radio is Region No. 1.
- Check the Rating Level.

Play starts, but then stops immediately

- The disc is dirty. Clean it.
- Condensation has formed. Allow player to dry out.

Continued on next page

Other Information

No sound or distorted sound.

- Make sure your TV/DVD/Radio is connected properly. Make sure all cables are securely inserted into the appropriate jacks.
- If you connected an audio or audio/video component to your TV/DVD/Radio, make sure you chose the correct input setting on the receiver and unit.

Can't advance through a movie

- You can't advance through the opening credits and warning information that appear at the beginning of movies because the disc is programmed to prohibit that action.

The icon appears on screen

- The feature or action cannot be completed at this time because:
 1. The disc's software restricts it.
 2. The disc's software doesn't support the feature (e.g., angles).
 3. The feature is not available at the moment.
 4. You've requested a title or chapter number that is out of range.

Picture is distorted

- The disc might be damaged. Try another disc.
- It is normal for some distortion to appear during forward or reverse scan.

No forward or reverse scan

- Some discs have sections that prohibit rapid scanning, or title and chapter skip.
- If you try to skip through the warning information and credits at the beginning of a movie, you won't be able to. This part of the movie is often programmed to prohibit skipping through it.

Subtitle and/or audio language is not the one selected from the initial setting

- If the subtitle and/or audio language does not exist on the disc, the initial settings will not be seen or heard. The disc's priority language is selected instead. Set the subtitle and/or audio language manually through the Info Display, if available.

Camera angle cannot be changed

- Some discs don't have the multi-camera angle system, and some discs only have it in certain parts of the movie.

Cannot copy discs to video tape

- You can't record DVD discs onto videocassettes because the discs are encoded with anti-copy protection.

Disc won't eject

- When you put a disc into the disc tray, it may take up to 15 seconds to read the disc, you won't be able to eject the disc during this time. Wait 15 seconds and try again.

Forgot Password

- If you forget your password, place remote in DVD mode by pressing the DVD button. Then press ENTER, TUNE-, and TUNE+ to reset password. The TV/DVD/Radio displays *RESET TO MANUFACTURE SETTING*. The display disappears after a few seconds and the screen goes blank. Press TV then DVD on the remote to return to DVD mode.

Remote Control Doesn't work

- Place the remote control extremely close to the sensor on your TV/DVD/Radio.
- The remote might be in the wrong mode. To be in the TV mode, press TV on the remote before you press any other buttons. To be in the DVD mode, press DVD on the remote. To be in the Radio mode, press AM FM on the remote.
- Maybe battery is weak or dead. Put new battery in the remote.
- High-efficiency fluorescent lighting might cause your TV/DVD/Radio lock up. To unlock, cover the remote sensor and press a mode button.

Limited Warranty

What your warranty covers:

- Defects in materials or workmanship.

For how long after your purchase:

- 1 year from date of purchase- Unit exchange, which includes parts and labor.
- The warranty for rental units begins with the first rental or 45 days from date of shipment to the rental firm, whichever comes first.

What we will do:

Exchange the unit with a new or, at our option, refurbished unit.

Continued on next page

Other Information

How you get service:

- Call 1-800-951-9582 and have your unit's date of purchase and model/serial number ready. The model/serial number information is on the back of your unit.
- A representative will troubleshoot your problem over the phone.
- If the representative determines that you should receive a replacement unit you will be provided with a Service Request (SR) number and the location of a nearby exchange point if one exists. No returns will be accepted without the SR number.

To receive a replacement unit before you return yours:

Option I:

1. Provide your Discover, MasterCard or Visa account number and expiration date to your phone representative. This is for security purposes only and your account will not be charged at this time.
2. We will send you a replacement unit.
3. If you return the unit to us within 14 days from the date you were provided a SR number, only items not covered by warranty will be charged to your account. If your unit is not received within 14 days, the suggested retail value of the receiver will be charged to your credit card. This amount will be credited, less a \$10 handling fee, if the unit is subsequently received.
4. Ship your defective unit back to us using the replacement unit's carton. Shipping instructions will be included on the carton along with your SR number which will allow you to easily ship the unit back to us. Make sure you insure your shipment in case of damage or loss. Include with the shipment:
 - Proof of purchase in the form of a bill of sale or receipted invoice which is evidence that the product is within the warranty period must be presented to obtain warranty service. For rental firms, proof of first rental is also required.
 - A brief note describing your receiver problem.
 - Your name, address and phone number.

Option II:

1. For a fee of \$10.00, we will send a replacement unit to our exchange point.
2. The exchange location will notify you of its arrival.
3. Take your unit and evidence of purchase date, such as a bill of sale, to the exchange location and you will be provided the new or refurbished unit. Please retain all accessories such as the remote control hand unit.
4. If the repairs are covered by your warranty, you will not be billed.

Thomson assumes no responsibility of warranty shipments from the customer to the factory if not shipped in the manner prescribed by Thomson.

Return transportation, storage, handling and insurance costs are your responsibility. We accept no responsibility in case of damage or loss.

To receive a replacement unit after we have received your unit:

- Write the SR number on the outside of the carton used to return the unit. Make sure you insure your shipment in case of damage or loss.
- Carefully pack the unit using the original box and packing material if possible. Please retain all accessories that were included with your unit such as the remote control hand unit.
- Include with the shipment:
 1. Proof of purchase in the form of a bill of sale or receipted invoice which is evidence that the product is within the warranty period must be presented to obtain warranty service. For rental firms, proof of first rental is also required.
 2. A brief note describing your unit's problem.
 3. Your name, address and phone number.
- The representative will advise the address to mail a cashier's check or money order for payment if there are any out of warranty labor or parts charges, and you elect not to use your credit card.
- After we receive your product, a new or refurbished unit will be shipped to you.

What your warranty *does not* cover:

- Acts of nature, such as but not limited to lightning damage.
- Adjustment of customer controls.
- Damage from misuse or neglect.
- A unit that has been modified or incorporated into other products or is used for institutional or other commercial purposes.
- Batteries.
- Units purchased or serviced outside the U.S.A.

Continued on next page

Other Information

- Shipping damage if the unit was not packed and shipped in the manner prescribed by Thomson.
- Storage fees may be charged by the exchange point if you fail to pickup the replacement unit in a timely manner.
- Customer Instruction. (Your Owner's Manual describes how to install, adjust, and operate your unit. Any additional information should be obtained from your dealer.)

Product Registration:

- Please complete and mail the Product Registration Card packed with your product. It will make it easier to contact you should it ever be necessary. The return of the card is not required for warranty coverage.

Limitation of Warranty:

- **THE WARRANTY STATED ABOVE IS THE ONLY WARRANTY APPLICABLE TO THIS PRODUCT. ALL OTHER WARRANTIES, EXPRESS OR IMPLIED (INCLUDING ALL IMPLIED WARRANTIES OF MERCHANTABILITY OR FITNESS FOR A PARTICULAR PURPOSE) ARE HEREBY DISCLAIMED. NO VERBAL OR WRITTEN INFORMATION GIVEN BY THOMSON MULTIMEDIA INC., ITS AGENTS OR EMPLOYEES SHALL CREATE A WARRANTY OR IN ANY WAY INCREASE THE SCOPE OF THIS WARRANTY.**
- **REPAIR OR REPLACEMENT AS PROVIDED UNDER THIS WARRANTY IS THE EXCLUSIVE REMEDY OF THE CONSUMER. THOMSON MULTIMEDIA INC. SHALL NOT BE LIABLE FOR INCIDENTAL OR CONSEQUENTIAL DAMAGES RESULTING FROM THE USE OF THIS PRODUCT OR ARISING OUT OF ANY BREACH OF ANY EXPRESS OR IMPLIED WARRANTY ON THIS PRODUCT. THIS DISCLAIMER OF WARRANTIES AND LIMITED WARRANTY ARE GOVERNED BY THE LAWS OF THE STATE OF INDIANA. EXCEPT TO THE EXTENT PROHIBITED BY APPLICABLE LAW, ANY IMPLIED WARRANTY OF MERCHANTABILITY OR FITNESS FOR A PARTICULAR PURPOSE ON THIS PRODUCT IS LIMITED TO THE APPLICABLE WARRANTY PERIOD SET FORTH ABOVE.**

How state law relates to warranty:

- Some states do not allow the exclusion nor limitation of incidental or consequential damages, or limitations on how long an implied warranty lasts, so the above limitations or exclusions may not apply to you.
- This warranty gives you specific legal rights, and you also may have other rights that vary from state to state.

If you purchased your product outside the United States:

- This warranty does not apply. See your dealer for warranty information.

Service calls which do not involve defective materials or workmanship are not covered by this warranty. Costs of such service calls are the sole responsibility of the purchaser.



Mounting Kit

The pieces in this kit allow you to mount your unit to your cabinet.



Remote Control

This is the remote control that came packed with your unit. Replacements or spares can be ordered as needed.

Detach Here



Accessory Order Form

Description	Part No.	Price	Qty
Mounting Kit	253185	\$15.95	
Remote Control	256517	\$49.95	

Please complete other side also

Prices are subject to change without notice.

Total Merchandise \$ _____
 Sales Tax \$ _____

We are required by law to collect the appropriate sales tax for each individual state, country, and locality to which the merchandise is being sent.

Shipping and Handling
 Total Amount Enclosed \$ 5.00

Use VISA, MasterCard, or Discover Card preferably. \$ _____

Money order or check must be in U.S. currency only.

No COD or CASH.

All accessories are subject to availability.
 Where applicable, we will ship a superseding model.

Continued on next page.....

Other Information

To Order

To place your order by phone, have your Visa, MasterCard or Discover Card ready and call the toll-free number listed below.

Use this number only to place an order for accessory items listed on this order form. **1-800-338-0376**

To place your order by mail, detach and mail the completed order form with credit card information, money order or check in US currency (made payable to Thomson multimedia Inc.) to the following address:

Video Accessories
PO Box 8419
Ronks, PA 17573

Detach Here



Charge your order on your VISA, MasterCard,
or Discover Card by filling in below

USE YOUR CREDIT CARD

IMPORTANT: Copy complete account number from your VISA card

Expiration date:

IMPORTANT: Copy complete account number from your MasterCard

Copy Number above your
name on MasterCard Expiration date:

IMPORTANT: Copy complete account number from your Discover Card

Expiration date:

AUTHORIZED SIGNATURE

Print or type your name and address clearly.

A complete and correct order will save you
days of waiting.

Name: _____

Street: _____

City: _____ Apt: _____

State: _____

Zip: _____

**Please make sure that both sides of this form
have been filled out completely.**

- Allow 4 weeks for delivery.
- All accessories are subject to availability.
- Prices are subject to change.

Index

Symbols

- 16:9 WS Wide screen 39
- 4:3 LB (Letter Box) 38
- 4:3 PS (Pan Scan) 38

A

- A-B repeat
 - Audio CD 29
 - DVD 23
- Accessory order form 49
- ADD/DELETE button 6, 11
- Adding channels 11
- AM/FM button 9, 34
- AM/FM MODE button 8
- Angle, camera 22
- Arrow (up and down) buttons 7
- Arrow up/down/left/right buttons 9
- ASPECT Ratio
 - 16:9 WS (Wide Screen) 38
 - 4:3 LB (Letter Box) 38
 - 4:3 PS (Pan Scan) 38

Audio

- QSurround 21
- Audio CD
 - A-B repeat 29
 - Cancelling repeat 29
 - Play mode 26
 - Program list 27
 - PROGRAM MENU 27
 - Program play 27
 - Repeat 28
 - Time display 26
 - Track 25
 - Using bookmarks 30
- Audio CDs 25
- AUDIO IN L/R jacks 5
- AUDIO Language 20, 37

- AUDIO OUT L/R jacks 5
- Auto channel search 11
- Auto program 11
- AUTO PROGRAM button 6

B

- Batteries, remote 9
- Bookmarks
 - Clearing 25, 30
 - Recalling 24, 30
 - Storing 24, 30
 - Using 24, 30
- Brightness 12
- Buttons
 - 0-9 and 100 9
 - ADD/DELETE 6
 - AM/FM 9, 34
 - AM/FM MODE 8
 - Arrow 9
 - Arrow up and down 7
 - AUTO PROGRAM 6
 - CLOCK 8
 - DISC MENU 9
 - DVD 9
 - DVD MENU 9, 36, 38
 - DVD MODE 8
 - ENTER 9, 36
 - FWD (fast forward) 8
 - INFO 10, 19
 - MUTE 9
 - OPEN/CLOSE 8
 - PIX (picture) 10, 12
 - PLAY/PAUSE 8
 - POWER 8, 10
 - RECALL 8, 34
 - RELEASE 8
 - REV (reverse) 8
 - SECURITY 8
 - STOP 8
 - STORE 8, 34
 - TUNE +/- 8, 10
 - TV 10
 - TV/CATV 6
 - VOL (volume) +/- 9, 10

C

- Camera angle 22
- CANCEL PASSWORD 39
- Cancelling repeat feature 24, 29
- CATV/TV button 6
- CDs, playing 25
- CHANGE PASSWORD 39
- Channel search 11
- Channels
 - Add/deleting 11
- Chapter, selecting 19
- Clearing a bookmark 25, 30
- CLOCK button 8, 10
- Color 12
- Controls
 - Remote control 9

D

- DELETE/ADD buttons 11
- Deleting channels 11
- Directory Tree MP3 31
- Disc contents menu 13
- DISC MENU button 9
- DISC MENU Language 37
- Disc types 13
- Discs
 - Loading and playing 14
 - Menu 15
- DVD
 - A-B repeat 23
 - Audio language 20
 - Bookmarks 24
 - Camera angle 22
 - Chapter 19
 - Repeat 23
 - Subtitle language 21
 - Subtitles 22
 - Time display 20
 - Title 19
 - Troubleshooting 43
 - DVD button 9

Other Information

DVD MENU button 9, 36, 38
DVD menus 36
DVD MODE button 8
DVD regional coding 12
DVDs
 Playing 18
DVD's info display 13
DVD's menu system 13

E

ENGLISH Language 37
ENTER button 9, 36
Erasing channels 11

F

Fast motion playback 33
FM ANTENNA jack 5
Folder, MP3 31
FRENCH Language 37
FWD (fast forward) button 8

G

GERMAN Language 37

I

INFO button 10, 19, 25
Info display 13
 Remove 19
Installing batteries 9
Invalid icon 18, 33
ITALIAN Language 37

J

Jacks
 FM ANTENNA 5
 L/R AUDIO IN 5
 L/R AUDIO OUT 5
 TV ANTENNA 5
 VIDEO IN 5

L

L/R AUDIO IN jack 5
L/R AUDIO OUT jack 5

Language

 Audio 20
 AUDIO 37
 DISC MENU 37
 DVD MENU 37
 ENGLISH 37
 FRENCH 37
 GERMAN 37
 ITALIAN 37
 Menu 37
 SPANISH 37
 Subtitle 21
 SUBTITLE 37

LCD display window 7

Letter Box 4:3 38

Limited warranty 45

Loading discs 14

M

Menu

 Disc contents 15
 Moving through 36
 O.S.D 36
 RATING 39
 VIDEO 38

Menu system 13

 DVD 36

Mounting instructions 4

Mounting kit 49

 Order form 49

MP3

 Directory Tree 31
 Folder 31
 Format 31
 Repeat 32
 Song 31

MP3 discs

 playing 31

MUTE button 9

N

Number buttons 9

O

O.S.D Menu 36

OPEN / CLOSE button 8, 14

Order form

 Mounting kit 49

Order form, accessory 49

P

Pan Scan picture 38

Password

 Cancel 39

 Change 39

Picture aspect 38

Picture scan 33

PIX (picture) button 9, 12

Play list

 Audio CD 27

Play mode

 Audio CD program 26

 Audio CD random 26

 Audio CD standard 26

Playback features 33

 Bookmarks 24

 Bookmarks 30

 Camera angle 22

 Fast motion 33

 Picture scan 33

 Repeat 23

 Repeat, Audio CD 28

 Repeat, MP3 32

Playing

 Audio CDs 25

 MP3 Discs 31

Playing discs 14

POWER button 8, 10

Problems

DVD 43

Radio 43

Remote control 45

TV 42

Program list

Audio CD 27

PROGRAM MENU

Audio CD 27

Program play

Audio CD 27

Q

Q Surround 21

Quality, picture 12

R

Radio 34

FM ANTENNA jack 5

Troubleshooting 43

Radio buttons

RECALL 8

STORE 8

Radio reception 43

Radio station

Storing 34

Tuning 34

RATING Level 39, 40

RATING menu 39, 40

RECALL button 8, 34

Recalling bookmarks 24, 30

Reception

Radio 43

TV 42

RELEASE button 8

Remote control 9

Installing batteries 9

Order form 49

SENSOR 8

Troubleshooting 45

Repeat 23

A-B 23

Audio CD 28

Cancelling 24, 29

MP3 32

Repeat, MP3

Turning off 32

REV (reverse) button 8

S

Screensaver 15, 31

SECURITY button 8

SENSOR 8

Set the time 10

Setup, TV 10

Skipping, tracks & songs 33

Song, MP3 31

Songs, skipping 33

SPANISH Lanugage 37

Standard play

Audio CD 26

STOP button 8

STORE button 8, 34

Storing bookmarks 24, 30

Subtitle

Turning on or off 22

SUBTITLE Language 37

Subtitle language 21

Surround sound 21

T

Time display

Audio CD 26

DVD 20

Time search 20

Time, setting 10

Tint 12

Title, seleting 19

Track, selecting a 25

Tracks, skipping 33

Troubleshooting 42

DVD 43

Radio 43

Remote control 45

TV 42

TUNE +/- buttons 8, 10

TV

ANTENNA jack 5

Reception 42

Setup 10

Signal 6, 11

Troubleshooting 42

TV ANTENNA jack 10

TV AUTO PROGRAM button 11

TV button 10

TV MODE button 8

TV/CATV button 6, 11

U

Under Cabinet

Mounting kit 49

Under cabinet

Mounting 4

Template 4

Tools required 4

Using bookmarks

Audio CD 30

DVD 24

V

VIDEO IN jack 5

Video Menu 38

VOL (volume) +/- buttons 9, 10

W

Warranty, limited 45

Wide Screen 16:9 picture 39

Visit the RCA website at www.rca.com

Please do not send any products to the Indianapolis address listed in this manual or on the carton. This will only add delays in service for your product.

Thomson multimedia Inc.
10330 North Meridian Street
Indianapolis, IN 46290

©2002 Thomson multimedia Inc.
Trademark(s)® Registered
Marca(s) Registrada(s)
Printed in Malaysia
TOCOM 15835690

THOMSON

THOMSON 

Free Manuals Download Website

<http://myh66.com>

<http://usermanuals.us>

<http://www.somanuals.com>

<http://www.4manuals.cc>

<http://www.manual-lib.com>

<http://www.404manual.com>

<http://www.luxmanual.com>

<http://aubethermostatmanual.com>

Golf course search by state

<http://golfingnear.com>

Email search by domain

<http://emailbydomain.com>

Auto manuals search

<http://auto.somanuals.com>

TV manuals search

<http://tv.somanuals.com>