

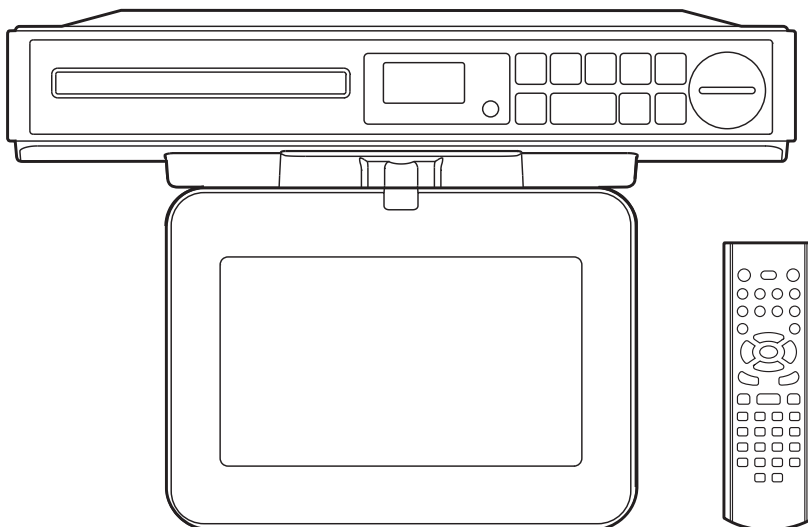

RCA

Model: SPS36073

7" Kitchen LCD TV / DVD Combo



OWNER'S MANUAL



SAFETY PRECAUTIONS

The following marks and symbols are located on top of the unit.



CAUTION
RISK OF ELECTRIC SHOCK
DO NOT OPEN



DO NOT EXPOSE THIS UNIT TO RAIN OR MOISTURE
WARNING: SHOCK HAZARD - DO NOT OPEN
AVIS: RISQUE DE CHOC ÉLECTRIQUE - NE PAS OUVRIR





THE LIGHTNING FLASH AND ARROWHEAD WITHIN THE TRIANGLE IS A WARNING SIGN ALERTING YOU OF "DANGEROUS VOLTAGE" INSIDE THE PRODUCT.



THE EXCLAMATION POINT WITHIN THE TRIANGLE IS A WARNING SIGN ALERTING YOU OF IMPORTANT INSTRUCTIONS ACCOMPANYING THE PRODUCT.

Caution marking is located on top enclosure of the unit.

 **WARNING:**
This product utilizes a laser. Use of controls or adjustments or performance of procedures other than those specified may result in hazardous radiation exposure. Do not open covers and do not repair yourself. Refer servicing to qualified personnel.

 **WARNING:**
TO REDUCE THE RISK OF FIRE OR ELECTRIC SHOCK, DO NOT EXPOSE THIS APPARATUS TO RAIN OR MOISTURE.
USE OF CONTROLS OR ADJUSTMENTS OR PERFORMANCE OF PROCEDURES OTHER THAN THOSE SPECIFIED MAY RESULT IN HAZARDOUS RADIATION EXPOSURE.
DANGER OF EXPLOSION IF BATTERY IS INCORRECTLY REPLACED. REPLACE ONLY WITH THE SAME OR EQUIVALENT TYPE.
MAIN PLUG IS USED AS DISCONNECT DEVICE AND IT SHOULD REMAIN READILY OPERABLE DURING INTENDED USE. IN ORDER TO DISCONNECT THE APPARATUS FROM THE MAINS COMPLETELY, THE MAINS PLUG SHOULD BE DISCONNECTED FROM THE MAINS SOCKET OUTLET COMPLETELY.

CAUTION
INVISIBLE LASER RADIATION IS EMITTED
WHEN OPENED AND INTERLOCKS
DEFEATED.
AVOID EXPOSURE TO BEAM

CLASS 1 LASER PRODUCT
APPAREIL À LASER DE CLASSE 1
PRODUCTO LASER DE CLASE 1



This product contains a low power laser device.



The symbol for Class II
(Double Insulation)

**This Class B digital apparatus
complies with Canadian ICES-003.**

For your safety

The AC power plug is polarized (one blade is wider than the other) and only fits into AC power outlets one way. If the plug won't go into the outlet completely, turn the plug over and try to insert it the other way. If it still won't fit, contact a qualified electrician to change the outlet, or use a different one. **DO NOT ATTEMPT TO BYPASS THIS SAFETY FEATURE.**

CAUTION: TO PREVENT ELECTRIC SHOCK, MATCH WIDE BLADE OF PLUG TO WIDE SLOT, FULLY INSERT.

 **WARNING:** Should any trouble occur, disconnect the AC power cord and refer servicing to a qualified technician.

1

RCA SPS36073 English IB W012 OK.indd 2 Download from www.Somanuals.com

8/21/2009 4:47:40 PM

SAFETY PRECAUTIONS

FCC Information

This device complies with part 15 of the FCC Rules. Operation is subject to the following two conditions: (1) This device may not cause harmful interference, and (2) this device must accept any interference received, including interference that may cause undesired operation.

This equipment has been tested and found to comply with the limits for a Class B digital device, pursuant to part 15 of the FCC Rules. These limits are designed to provide reasonable protection against harmful interference in a residential installation. This equipment generates, uses and can radiate radio frequency energy and, if not installed and used in accordance with the instructions, may cause harmful interference to radio communications. However, there is no guarantee that interference will not occur in a particular installation. If this equipment does cause harmful interference to radio or television reception, which can be determined by turning the equipment off and on, the user is encouraged to try to correct the interference by one or more of the following measures:

- Reorient or relocate the receiving antenna.
- Increase the separation between the equipment and receiver.
- Connect the equipment into an outlet on a circuit different from that to which the receiver is connected.
- Consult the dealer or an experienced radio/TV technician for help.

WARNING: Changes or modifications to this unit not expressly approved by the party responsible for compliance could void the user's authority to operate the equipment.

Warnings:

- The mains plug is used as disconnect device and it should remain readily operable during intended used. In order to disconnect the apparatus from the mains completely, the main plug should be disconnected from the mains socket outlet completely.
- Minimum 10 cm (4 inches) distances around the apparatus for sufficient ventilations.
- The ventilation should not be impeded by covering the ventilation openings with items such as newspaper, table-cloths, curtains, etc.
- The use of apparatus in moderate climates.

On Placement

- Do not use the unit in places which are extremely hot, cold, dusty, or humid.
- Do not restrict the air flow of the unit by placing it in a place with poor air flow, by covering it with a cloth, or by placing it on carpeting.

On Safety

- When connecting or disconnecting the AC power cord, grip the plug and not the cord itself. Pulling the cord may damage it and create a hazard.

On Condensation

- When left in a heated room where it is warm and damp, water droplets or condensation may form inside the unit. When there is condensation inside the unit, the unit may not function normally. Let the unit stand for 1 to 2 hours before turning the power on, or gradually heat the room and allow the unit to dry before use.

Note on Copyright

It is forbidden by law to copy, broadcast, show, broadcast on cable, play in public, or rent copyrighted material without permission.

Apparatus Claims of U.S. Patent Nos. 6,836,549; 6,381,747; 7,050,698; 6,516,132; and 5,583,936 licensed for limited viewing uses only.

This product incorporates copyright protection technology that is protected by U.S. patents and other intellectual property rights. Use of this copyright protection technology must be authorized by Macrovision, and is intended for home and other limited viewing uses only unless otherwise authorized by Macrovision. Reverse engineering or disassembly is prohibited.

IMPORTANT SAFETY INSTRUCTIONS

1. Read these instructions.
2. Keep these instructions.
3. Heed all warnings.
4. Follow all instructions.
5. Do not use this apparatus near water.
6. Clean only with a dry cloth.
7. Do not block any of the ventilation openings. Install in accordance with the manufacturer's instructions.
8. Do not install near any heat sources such as radiators, heat registers, stoves, or other apparatus (including amplifiers) that produce heat.
9. Do not defeat the safety purpose of the polarized or grounding-type plug. A polarized plug has two blades with one wider than the other. A grounding type plug has two blades and a third grounding prong. The wide blade or the third prong are provided for your safety. When the provided plug does not fit into your outlet, consult an electrician for replacement of the obsolete outlet.
10. Protect the power cord from being walked on or pinched particularly at plugs, convenience receptacles, and the point where they exit from the apparatus.
11. Only use attachments/accessories specified by the manufacturer.
12. Use only with a cart, stand, tripod, bracket, or table specified by the manufacturer, or sold with the apparatus. When a cart is used, use caution when moving the cart/apparatus combination to avoid injury from tip-over.
13. Unplug this apparatus during lightning storms or when unused for long periods of time.
14. Refer all servicing to qualified service personnel. Servicing is required when the apparatus has been damaged in any way, such as the power-supply cord or plug is damaged, liquid has spilled or objects have fallen into the apparatus, the apparatus has been exposed to rain or moisture, does not operate normally, or has been dropped.



Portable Cart Warning

Additional Safety Information

- The apparatus shall not be exposed to dripping or splashing and that no objects filled with liquids, such as vases, shall be placed on apparatus.
- Always leave sufficient space around the product for ventilation. Do not place product in or on a bed, rug, in a bookcase or cabinet that may prevent air flow through vent openings.
- Do not place lighted candles, cigarettes, cigars, etc. on the product.
- Connect power cord only to AC power source as marked on the product.
- Care should be taken so that objects do not fall into the product.
- Do not attempt to disassemble the cabinet. This product does not contain customer serviceable components.

IF YOUR PRODUCT OPERATES ON BATTERIES, adhere to the following precautions:

- A. Do not mix old and new batteries.
- B. Do not mix alkaline, standard (carbon-zinc), or rechargeable (NiCd, NiMH, etc) batteries.
- C. Any battery may leak electrolyte or explode if disposed of in fire or an attempt is made to charge a battery not intended to be recharged.
- D. Discard leaky batteries immediately. Leaking batteries can cause skin burns or other personal injury. When discarding batteries, be sure to dispose of them in the proper manner, according to your state/provincial and local regulations.
- E. Battery shall not be exposed to excessive heat such as sunshine, fire or the like.

TABLE OF CONTENTS

Safety Precautions	1-2	Repeat Playback	19
Important Safety Instructions	3	Programmable Memory	20
Table of Contents	4	DVD programmed Memory.....	20
Disc Formats	5	CD programmed Memory.....	20
Accessories	6	Viewing JPEG Files	21
Remote Control	6	Viewing jpeg Files	21
Control Reference Guide	7-9	Customizing the Function Settings	21-22
Mounting Instructions	10-11	Language Setup.....	21
Connections	12-13	Video Setup.....	22
Connecting the TV Antenna	12	System Setup.....	22
Connecting the Unit to a TV or Other Video Equipment.....	12	Using the TV	23
Connecting the AM LOOP Antenna	12	Scanning for TV Channels Automatically (Only Appears to the First Time Power On).....	23
Plugging in the Unit.....	13	Manual Searching for TV Channels.....	23
Monitor Operation	13	Watching Television.....	23
Unit Operation	14	TV Setup	24-26
Sound System	14	Picture Setting.....	24
Setting the Clock	15	Sound Setting.....	24
Setting the Cooking Timer	15	TV Timer Setting.....	25
Playing a Disc	16-18	Misc Setting.....	25
Playing a Disc.....	16	TV Channel Setting.....	26
Pausing Playback (Still Mode).....	16	Listening to the Radio	27
Stopping Playback.....	16	Troubleshooting Guide	28
Skipping to a Different Chapter/Track.....	16	Maintenance	29
Fast Forward/Fast Reverse	16	Specifications	29
Angle Selection	17		
Subtitle Selection	17		
Audio Selection	17		
Display Function	18		
Special Function	18		
Locating a Specific Title/Chapter(DVD).....	18		
Locating a Specific Time.	18		

DISC FORMATS

The unit can play



DVDs
[8cm/12cm disc]



CD-R CD-RW

Compatible



Audio CDs
[8cm/12cm disc]

Region Management Information

Region Management Information: This unit is designed and manufactured to respond to the Region Management Information that is encoded on DVDs. If the region number printed on the DVD does not correspond to the region number of this unit, this unit cannot play that disc.

The region number of this unit is 1.



Disc Function or Operation that is Not Available

When the symbol appears on the screen, it indicates that the function or operation attempted is not available at that time. This occurs because the DVD manufacturer determines the specific functions. Certain functions may not be available on some discs. Be sure to read the documentation provided with the DVD.

Icons Used on DVDs

Sample Icons

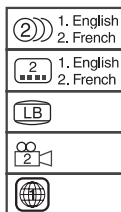

Language selections for audio

Language selections for subtitles

Screen aspect ratio

Multiple camera angles

Region code indicator

NOTE:

When playing a CD-G (Graphics) or CD EXTRA disc, the audio portion will be played, but the graphic images will not be shown.

Titles, Chapters and Tracks

- DVDs are divided into “titles” and “chapters”. If the disc has more than one movie on it, each movie would be a separate “title”. “Chapters” are sections of titles.
- Audio CDs are divided into “tracks”. A “track” is usually one song on an Audio CD.

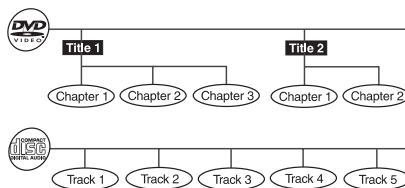

NOTE: Numbers identify each title, chapter, and track on a disc. Most discs have these numbers recorded on them, but some do not.

Note on Unauthorized Discs

You may not be able to play back some DVDs on this unit if they were purchased from outside your geographic area or made for business purposes.

ACCESSORIES

Please Check and Identify the Included Accessories.

- Remote controlx 1
- AAA 1.5V batteryx 2
- Mounting templatex 1
- 1.06" (27mm) spacers.....x 4
- .57" (14.4mm) spacers.....x 4
- #M 5 x 69 mm screws.....x 4
- AM LOOP antennax 1

REMOTE CONTROL

Using the Remote Control

- This remote control is magnetic and can be attached to most refrigerators. Some refrigerators panels are not metallic. In this case, try attaching the magnetic remote control to the side of the refrigerator.
- Point the remote control at the REMOTE SENSOR located on the unit.
- When there is a strong ambient light source, the performance of the infrared REMOTE SENSOR may be degraded, causing unreliable operation.
- The recommended effective distance for remote operation is about 16 feet (5 meters).

To Install Batteries

1. Open the battery door.

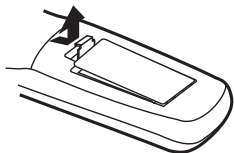

2. Insert two AAA batteries.

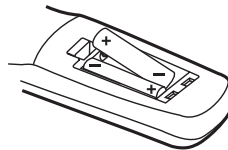

Battery Replacement

When the batteries become weak, the operating distance of the remote control is greatly reduced and you will need to replace them.

Caution: Danger of explosion if battery is incorrectly replaced. Replace only with the same or equivalent type.

NOTE:

- Do not place the remote control near magnetic devices or magnetic cards.
- If the remote control is not going to be used for a long time, remove the batteries to avoid corrosion damage caused by battery leakage.
- Do not mix old and new batteries. Do not mix ALKALINE, standard (CARBON-ZINC) or rechargeable (NICKEL-CADMIUM) batteries.
- Always remove batteries as soon as they become weak.
- Batteries shall not be exposed to excessive heat such as sunshine, fire or the like.
- Weak batteries can leak and severely damage the remote control.









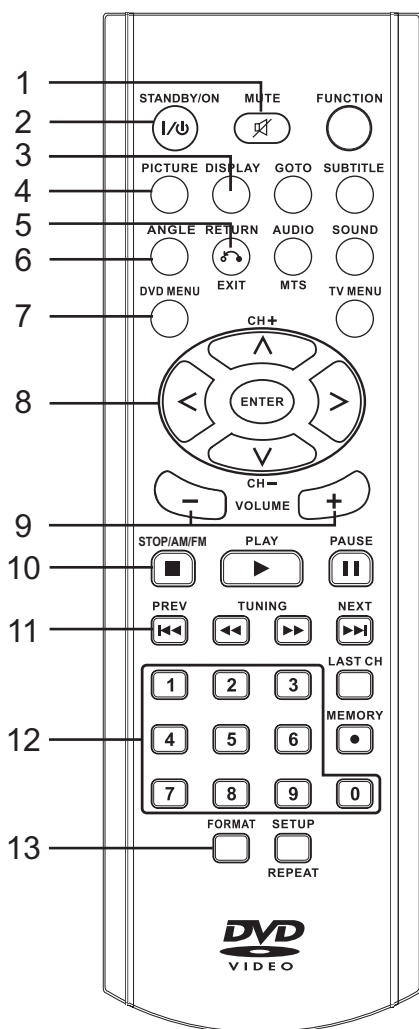





WARNING: Do not dispose of batteries in a fire. Batteries may explode or leak.

CAUTION: When discarding batteries, environmental problems must be considered and local rules or laws governing the disposal of these batteries must be strictly followed.

CONTROL REFERENCE GUIDE

Remote Control



- 1) **MUTE**  **Button**
Press to turn off the sound.
- 2) **STANDBY/ON**  **Button**
Turns on the unit and puts it in standby mode.
- 3) **DISPLAY**  **Button**
Changes disc status information displayed on the screen.
- 4) **PICTURE**  **Button**
Selects from preset screen display settings to match the type of show you are watching.
- 5) **RETURN/EXIT**  **Button**
Press to exit the TV menu and return directly to normal viewing.
- 6) **ANGLE**  **Button**
During DVD playback, switch the camera angle of the video presentation when scenes with multiple camera angles are recorded on a DVD.
- 7) **DVD MENU**  **Button**
Press to enter the main menu of the DVD you are watching.
- 8) **CURSOR** (, , , ) **Buttons**
Use to highlight selections on a screen and make adjustments to certain settings.
^ CH+ / v CH- buttons
Use to change TV channels.
ENTER  **Button**
Confirm selections on a menu screen.
- 9) **VOLUME (+/-) Buttons**
Adjusts the volume.
- 10) **STOP/AM/FM**  **Button**
Stops playback.
Switches between AM and FM.
- 11) **PREV**  **Button**
Selects previous title, chapter or track on a disc.
Selects previous preset station in radio mode.
- 12) **Number (0-9) Buttons**
- 13) **FORMAT**  **Button**
Press to set size of LCD display (4:3, wide).

CONTROL REFERENCE GUIDE

Remote Control

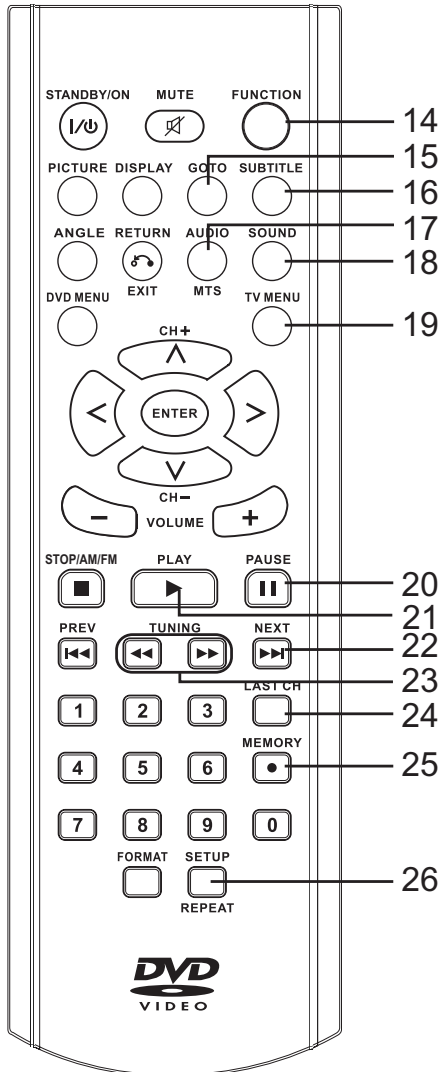

- 14) FUNCTION Button**
Use to select DVD, TV or RADIO mode.
- 15) GOTO Button**
Goes directly to a programmed location on a DVD/CD.
- 16) SUBTITLE Button**
Selects one of the subtitle languages programmed on a DVD.
- 17) AUDIO Button**
Selects audio soundtracks of a DVD or changes the output mode of a CD.
- MTS Button**
Press to select MONO sound, STEREO sound or Secondary Audio Program (SAP).
- 18) SOUND Button**
Press to select from preset sound settings to match the type of show you are watching.
- 19) TV MENU Button**
Press to display the on-screen TV menu.
- 20) II PAUSE Button**
Pauses playback, frames advance.
- 21) ► PLAY Button**
Starts playback.
- 22) ►► NEXT Button**
Selects next title, chapter or track on a disc.
Selects next preset station in radio mode.
- 23) ◀◀ TUNING ▶▶ Buttons**
Scans all available radio stations.
◀◀ : Fast reverse playback.
▶▶ : Fast forward playback.
- 24) LAST CH Button**
Press to switch repeatedly between the last two channels displayed.
- 25) MEMORY Button**
Sets title/chapter/track in a favorite order.
Enters the number of a selected station.
- [dot] Button**
Press to enter digital sub-channels (i.e. 11.3, 12.7).
- 26) SETUP Button**
Enters and exits the SETUP menu of the DVD in STOP mode.
- REPEAT Button**
Repeats chapter or title of a DVD.
Repeats single track or whole CD.

CONTROL REFERENCE GUIDE

Unit

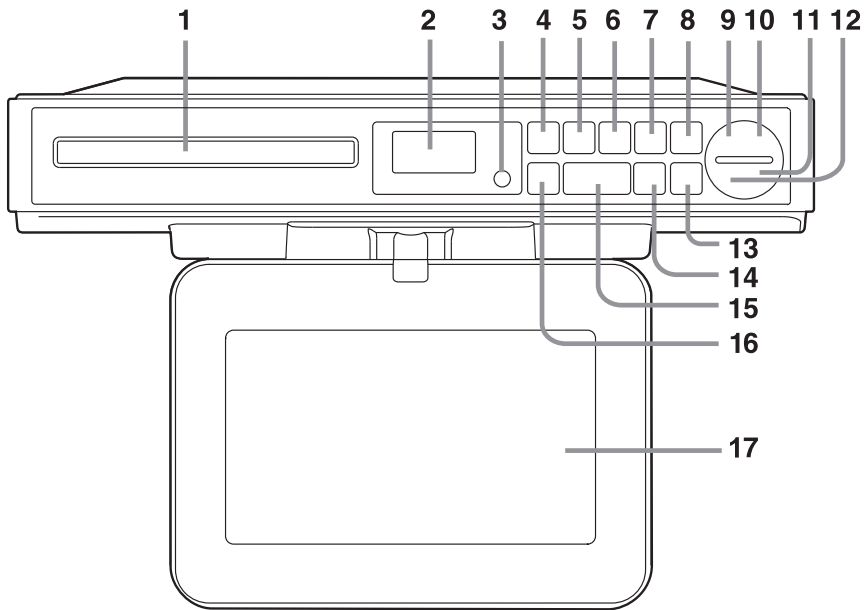

- 1) **Disc Tray**
Press OPEN/CLOSE button to open or close the tray.
Place a disc on the disc tray, label side up.
- 2) **Display Window**
Displays system information.
- 3) **Remote Sensor**
Receives the remote control unit signals.
- 4) **ON/OFF Button**
Turns the unit on and off.
- 5) **▶ PLAY Button**
Press to start or resume playback of a disc.
- 6) **■ /AM/FM Button**
Stops playing a disc.
Switches between AM and FM.
- 7) **TIMER Button**
Use to set the cooking timer.
- 8) **ENTER Button**
Use to enter the sub-menu and confirm selections on a menu screen.
- 9) **◀◀ /CH ▾ Button**
Press to go back to previous chapters / tracks in DVD mode.
Press to change TV channel in TV mode.
- 10) **▶▶ /CH ▲ Button**
Use to search for a station automatically or select presetted stations.
Press to advance to chapters / tracks in DVD mode.
Press to change TV channel in TV mode.
Use to search for a station automatically or select presetted stations.
- 11) **VOL + / > Buttons**
Increases the volume level.
Makes adjustments to certain settings.
- 12) **VOL - / < Buttons**
Decreases the volume level.
Makes adjustments to certain settings.
- 13) **TV MENU Button**
Opens and closes the TV menu.
- 14) **SET CLOCK Button**
Use to set the current time.
- 15) **DVD/TV/RADIO Button**
Use to select DVD, TV or RADIO mode.
- 16) **▲ OPEN/CLOSE Button**
Use to open / close the disc tray.
- 17) **Screen**

MOUNTING INSTRUCTIONS

TOOLS NEEDED: 1) Electric drill with 1/4" bit; 2) Phillips-head (cross style) screwdriver.

STEP 1

If your cabinet does **NOT** have an overhang:

- Place the Mounting Template in the desired location inside or underneath the cabinet (whichever has less obstructions, and will be easier for you to reach to drill holes), flush with the front edge of the cabinet and tape it down. Go to **STEP 2**.

If your cabinet **DOES** have an overhang:

- Measure the thickness "T" of the cabinet overhang (see Figure 1).

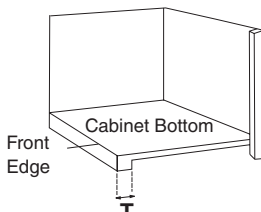

Figure 1

- Fold the Mounting Template along the guideline that is closest to the thickness of your cabinet overhang.
- Tape Mounting Template to the underside of the cabinet with the folded portion of the Mounting Template flush up against the cabinet overhang (see Figure 2). Go to **STEP 2**.

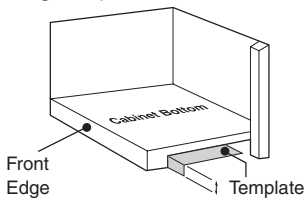

Figure 2

STEP 2

Use an electric drill with a 1/4" drill bit (not included) to drill all four holes marked on the Mounting Template (see Figure 3). To reduce splintering, place a small piece of masking tape over each hole location before drilling. Go to **STEP 3**.

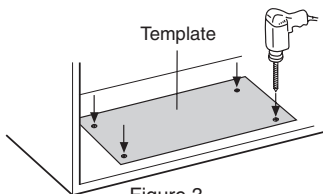

Figure 3

STEP 3

If your cabinet does **NOT** have an overhang:

- Eight screws are included with this unit, but you will only need four of them. Select the screw length which will go completely through your cabinet bottom, and provide at least 3/8" of thread to screw into the main unit.
- Insert the four selected screws through each hole from the inside of the cabinet going down (see Figure 4).

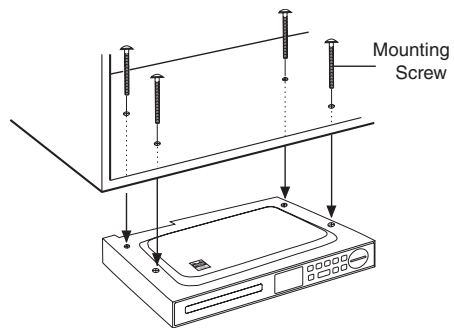

Figure 4

- Hold the unit up against the bottom of the cabinet, and align the four holes on the top of the unit with the screws. Partially tighten each screw, but do not fully tighten the screws until all of them have been started.
- Gently tighten each screw until they are firmly holding the unit in place.

If your cabinet **DOES** have an overhang:

- Four screws are included with this unit. Make sure the screws will go completely through your cabinet bottom, and extend at least 3/8" past the bottom of your cabinet overhang.
- This unit includes two sets of four spacers of different length. The spacers can be put together to form longer spacers to accommodate various cabinet overhang thicknesses. Determine the best combination of spacers which is equal to or longer than the cabinet overhang thickness.

(Continued on next page)

MOUNTING INSTRUCTIONS

(Continued from previous page)

- c) Insert the four selected screws through each hole from the inside of the cabinet going down (see Figure 5).

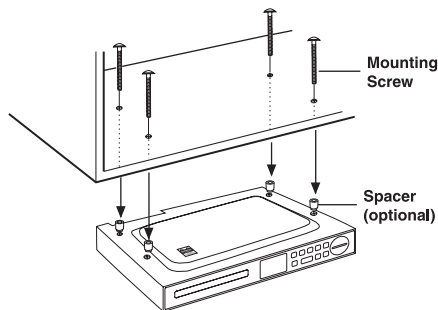

Figure 5

- d) Hold each screw head down and push the unit and spacers onto the screws, then hold the unit up until spacers are firmly against the bottom of the cabinet (and fully nested within each other if you are using multiple spacers for each screw).

- e) Partially tighten each screw, but do not fully tighten the screws until all of them have been started (see Figure 6).

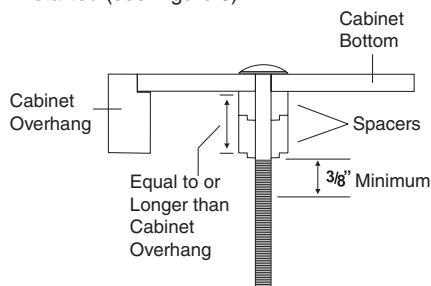

Figure 6

- f) Gently tighten each screw until they are firmly holding the unit in place. The top front edge of the unit should clear the overhang.

⚠ CAUTION

TO REDUCE THE RISK OF FIRE, DO NOT PLACE ANY HEATING OR COOKING APPARATUS BENEATH THIS UNIT.

Mounting Suggestions

- 1) If your cabinet has obstructions inside it which prevent you from using the template, cut out the corresponding area on the template, but do NOT cut out or through the screw holes.
- 2) If your cabinet has obstructions underneath it, which will interfere with the mounting of the unit, remove the obstruction before mounting the unit, or find another location to mount the unit.
- 3) It is recommended that you wear safety glasses while drilling to prevent eye injuries.
- 4) For wood cabinets, you may want to mark the hole locations with a nail, pressed gently but firmly into the wood so that a slight impression is made. This will also help keep the drill bit centered in the right location.
- 5) Hold the drill firmly against the cabinet to keep the drill from "walking".

CONNECTIONS

Connecting the TV Antenna

Connect a TV antenna or CATV cable or Satellite system to the TV antenna terminal.

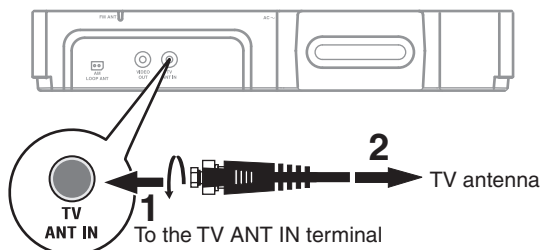

Connecting the Unit to a TV or other Video Equipment

Use the Video cable (not supplied). Connect the VIDEO OUT on the rear of the unit to the VIDEO IN on your TV or other video equipment.

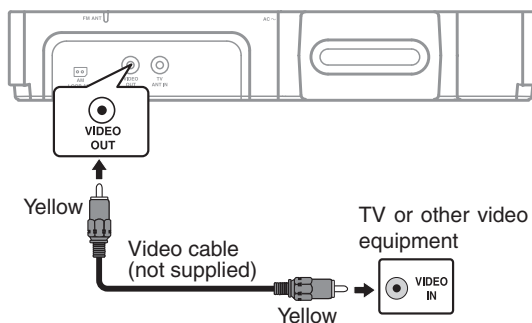

Connecting the AM LOOP Antenna

Connect the AM LOOP antenna (included) to the AM LOOP ANT terminal.

FM: Fully unwind the antenna wire and position it for the best reception.

AM: Fully unwind and rotate the loop antenna, then position it for the best reception.

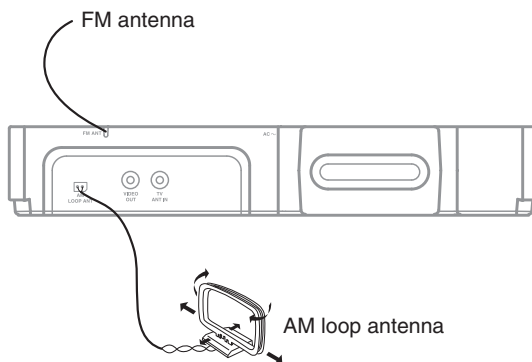

CONNECTIONS

Plugging in the Unit

Plug the AC power cord into the wall outlet

- Before plugging in the power cord, make sure the voltage of the unit matches your local voltage.
- Plug the power cord directly into the nearest wall outlet, and wrap the remaining cord around the cord storage knob at the rear of the unit.

CAUTION:

TO PREVENT ELECTRIC SHOCK, MATCH WIDE BLADE OF PLUG TO WIDE SLOT OF WALL OUTLET, THEN FULLY INSERT.

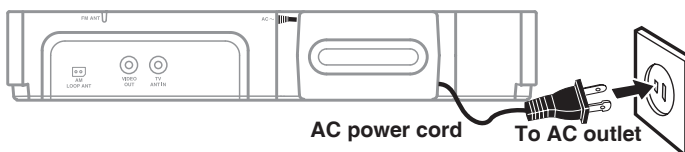

MONITOR OPERATION

Follow the illustrations below to open the monitor.

1. Gently pull the monitor down from the back, and twist it clockwise so the screen is visible.

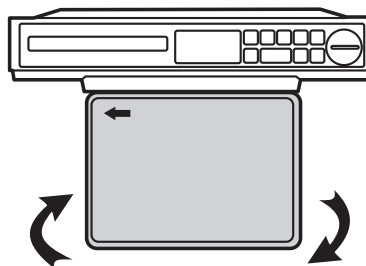
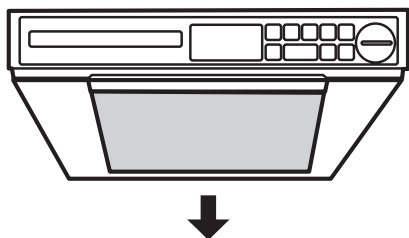

2. The screen can be turned up to 270°. Do NOT force the screen once it stops turning. The screen does NOT turn completely around.

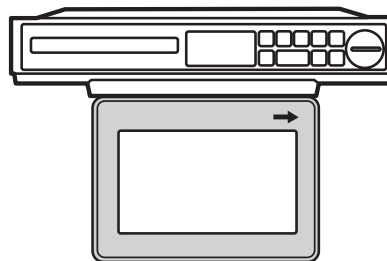
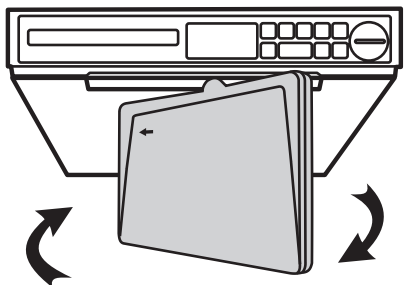

UNIT OPERATION

Turning the Unit On

While the power cord is connected and the unit is on standby, power will be consumed and only the clock display will flash.

- Press the **ON/OFF** button to turn the unit on, "DVD" will appear on the front display. After a short period of time, the DVD logo (start-up picture) will appear on the screen.



- Press the **DVD/TV/RADIO** button (the **FUNCTION** button on the remote control) to TV mode, "TV" will appear on the front panel display. After a short period of time, and the TV program will begin on the screen.



- Press the **DVD/TV/RADIO** button (the **FUNCTION** button on the remote control) to RADIO mode, FM frequency will appear on the front panel display. After a short period of time, the station will begin.



SOUND SYSTEM

Dolby Digital (for DVD)

Dolby Digital is a technology developed by Dolby Laboratories. Soundtracks encoded in Dolby Digital can reproduce from one to 5.1 discrete channels of excellent quality audio.

The unit automatically recognizes the Dolby Digital bitstream and provides a downmix suitable for two-channel listening. An additional Dolby Digital decoder is required for reproduction of the discrete multi-channel soundtracks available on many DVDs.



Manufactured under license from Dolby Laboratories.

'Dolby' and  the double-D symbol are trademarks of Dolby Laboratories.

SETTING THE CLOCK

To adjust the clock, the unit must be in standby mode. To enter standby mode, make sure that the unit is plugged in, but not turned on.

- Check that the rated voltage of the unit matches your local voltage.
1. When the AC power cord is plugged in, the clock display will blink.
 3. Press the **◀◀ / ▶▶** buttons to set the current hours then press the **SET CLOCK** button once to confirm. The MINUTES will now blink.

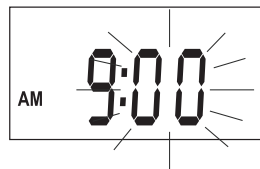
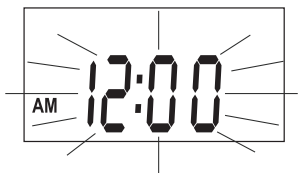

2. Press the **SET CLOCK** button until the HOUR blinks.
4. Press the **◀◀ / ▶▶** buttons to set to desired time then press the **SET CLOCK** button once to start the clock.

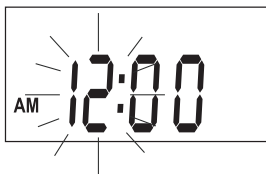

SETTING THE COOKING TIMER

1. Press the **TIMER** button. The "TIMER" indicator appears and the cooking time "10" blinks.
3. When the preset time elapses, the ALARM will sound.

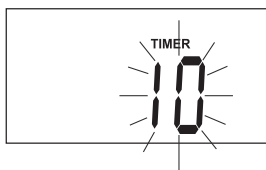



2. Press the **◀◀ / ▶▶** buttons on the unit to select your desired time from 1-99 minutes.
 - Press the **TIMER** button repeatedly to select following preset times: 10, 15, 30, 45, 60, 75, 90 minutes. You can then "fine-tune" your time by using the **◀◀ / ▶▶** buttons on the unit.
 - Press and hold the **◀◀ / ▶▶** buttons on the unit to fast forward/reverse to desired time.
4. To turn OFF the ALARM, press the **TIMER** button once. Otherwise, the ALARM will automatically turn off after 60 minutes if no button is pressed.

Canceling the Cooking Timer

- Press the **TIMER** button until the time of the cooking timer shows "OFF". The "TIMER" indicator will disappear.

PLAYING A DISC

This owner's manual explains the basic instructions of this unit. Some DVDs are produced in a manner that allows specific or limited operation during playback. Such as, the unit may not respond to all operating commands. This is not a defect in the unit. Refer to the instruction notes of discs.

"" may appear on the screen during operation. A "" means that the desired operation is not permitted by the unit or disc.

Playing a Disc

1. Press the **ON/OFF** button to turn on the unit.
 2. Press the **DVD/TV/RADIO** button (the **FUNCTION** button on the remote) to select DVD mode.
See **CUSTOMIZING THE FUNCTION SETTINGS** (page 21 to 22) before proceeding to step 3.
 3. Press the **OPEN/CLOSE** button. The disc tray opens.
 4. Place a disc onto the disc tray with the label side up.
 5. Press the **OPEN/CLOSE** button. The disc tray closes.
It takes a short while for your unit to load the disc. After loading, the unit will automatically either bring you to the main menu of the DVD or start playback of the disc.
 6. If the unit does not automatically start playing the DVD, press the **PLAY** button.
- When **MUTE** is pressed, the sound is mute and the "L " indicator always blinks on the LCD display until **MUTE** is pressed again or **VOL** is pressed.

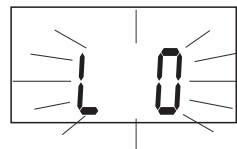

Pausing Playback (Still Mode)

Press the **PAUSE** button on the remote control. To resume normal playback, press the **PLAY** button. Each time you press the **PAUSE** button, the picture advances one frame.

Stopping Playback

Press the **STOP** button at the location where you want to interrupt playback. To resume playback at the position where the disc was stopped, press the **PLAY** button.

If you press the **STOP** button twice, the unit's memory will be cleared and pressing the **PLAY** button will reset the disc to the beginning.

Skipping to a Different Chapter/Track

- Press the **PREV** button repeatedly to skip to the start of the current or previous chapter/track.
- Press the **NEXT** button to skip to the next chapter/track.
- For an audio CD, use the number buttons (remote control only) to go directly to that track number.

Fast Forward/Fast Reverse

1. Press the **TUNING** **FF** or **RR** button on the remote control when a disc is playing.
 - The disc begins fast scan at x2 speed.
 - Six speeds are available. Each time the **TUNING** **FF** or **RR** button is pressed, the speed of fast scan changes in the following sequence:



2. Press the **PLAY** button when you have reached the desired point to resume playback at normal speed.

NOTE:

- The DVD player mutes sound during reverse and forward scan of DVD video discs.
- The fast playback speed may differ depending on the disc.

PLAYING A DISC

Angle Selection

Some DVDs contain scenes which have been shot from a number of different angles. For these discs, the same scene can be viewed from each of these different angles.

1. While you are playing a DVD with different angles recorded, press the **ANGLE** button to view the number of current angles available.
2. Press the **ANGLE** button repeatedly to change the scene to the next angle in those recorded.
 - About two seconds later, playback continues from the new angle selected.
 - If no button is pressed within 10 seconds, playback continues without changing the current angle.

Sequence of angle shots
(Example)

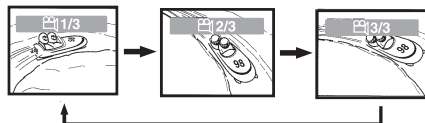

NOTE:

- This function can only be used for discs on which scenes shot from multiple angles have been recorded.
- If only one angle is recorded, " 1" is displayed.

Subtitle Selection

1. While a DVD is playing, press the **SUBTITLE** button to display the current language setting, as shown in the example below.
2. Press the **SUBTITLE** button repeatedly to select the desired subtitle language.

Subtitle: English 1/3

NOTE:

- If only one language is recorded, the language does not change.
- About two seconds later, playback continues with the new subtitle selected.
- The number of languages recorded differs depending on the disc.
- If no button is pressed within a few seconds, playback continues without changing the current subtitle.
- This function can only be used for discs on which subtitles have been recorded in multiple languages.
- On some DVDs, subtitles are activated from the main menu of the DVD. Press the **DVD MENU** button to activate the main menu.

Audio Selection

On some discs, the sound is recorded in two or more formats. Follow the directions below to select the type of playback.

1. While a disc is playing, press the **AUDIO** button to show the current audio format number.
2. Press the **AUDIO** button repeatedly to select the desired audio format.

 :  D 6CH English 1/3

NOTE:

- If only one audio format is recorded, the number does not change.
- Some DVD discs allow you to change audio selections only via the disc menu. If this is the case, press the **DVD MENU** button and choose the appropriate language on the disc menu.
- You can select different audio channels (Left, Right or Stereo) on an audio CD by pressing the **AUDIO** button repeatedly.

PLAYING A DISC

Display Function

While the disc is playing, press the **DISPLAY** button on the remote control repeatedly to display information on operation status.

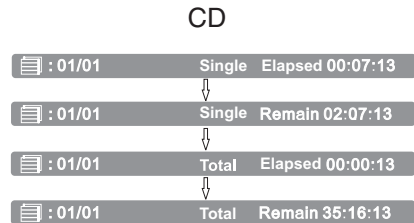
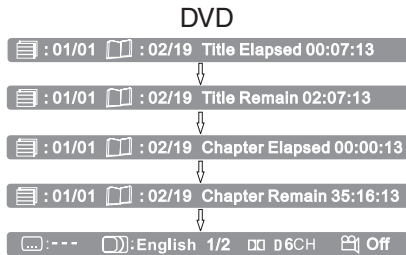

SPECIAL FUNCTION

Locating a Specific Title/Chapter

If a DVD contains title/chapter numbers, you can locate a specific title/chapter by directly selecting a title/chapter number.

1. In STOP/PLAY mode, press the **GOTO** button.
2. Press the **←** or **→** button to highlight a specific field and press the **↖** or **↘** button to select the title/chapter you want.
3. Press the **ENTER** button to confirm. Playback starts from the selected title/chapter.



Locating a Specific Time

You can move to a specific location by entering its corresponding time (hours, minutes, seconds).

1. Press the **GOTO** button twice for DVD (once for CD), a screen shown as right will be displayed on the screen.
2. Enter the corresponding number buttons for the setting point you want.
3. Press the **ENTER** button to confirm. Playback starts from the selected location.

DVD



CD



NOTE:

- If the time numbers you entered is not permitted by the disc, after you press the **ENTER** button,  will appear on the screen. You should reset and enter correct numbers.
- Some discs may not respond to this process.
- Some scenes may not be located as precisely as specified.
- This method for accessing specific locations is available only within the current title of the disc.

REPEAT PLAYBACK

You can play a specific title, chapter or track repeatedly. (Title repeat, chapter repeat, entire DVD repeat)

Repeating a Chapter

You can play the same chapter repeatedly.

While the disc is playing, press the **REPEAT** button repeatedly until the  indicator displays on the screen. The current chapter is played repeatedly.

Repeating a Title

You can play the same title repeatedly.

While the disc is playing, press the **REPEAT** button repeatedly until the  indicator displays on the screen. The current title is played repeatedly.

Repeating an Entire DISC

While the disc is playing, press the **REPEAT** button repeatedly until the  indicator displays on the screen. The entire disc is played repeatedly.

To Resume Normal Playback

While the disc is playing, press the **REPEAT** button repeatedly until the  indicator displays on the screen.

You can play a single track or an entire disc repeatedly.

Repeating a Single Track

You can play the same track repeatedly.

While the disc is playing, press the **REPEAT** button repeatedly until the  indicator displays on the screen. The current track is played repeatedly.

Repeating an Entire DISC

While the disc is playing, press the **REPEAT** button repeatedly until the  indicator displays on the screen. The entire disc is played repeatedly.

To Resume Normal Playback

Press the **REPEAT** button repeatedly until the  indicator displays on the screen.

PROGRAMMABLE MEMORY

DVD Programmed Playback

You can combine your favorite titles/chapters and play them in the order you determine.

1. Press the **MEMORY** button in PLAY/STOP mode. A screen will be shown as right.
2. Press the **>** button to highlight the Title. Press the **^** or **v** button to choose a desired title. Press the **>** button again to highlight a Chapter. Press the **^** or **v** button to choose the desired Chapter. Press the **ENTER** button to confirm. The highlight bar will move to the next item automatically.
3. Repeat step 2 to add additional titles and chapters.
4. Press the **▶ PLAY** button to start the programmed playback.

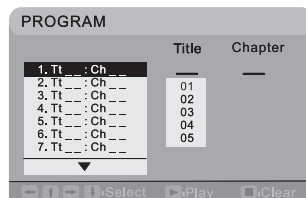

To Change the programmed selections

- 1 Press the **MEMORY** button.
- 2 Press the **■** button to clear one item, then press the **v** button to clear them one by one.
- 3 Follow above step 2 of Title/Chapter Programmed Playback to program the new title and chapter.
4. Press the **▶ PLAY** button to start the programmed playback.

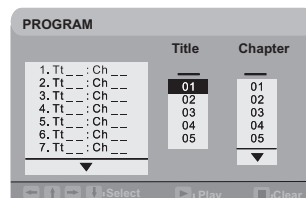

To Resume Normal Playback from Programmed Playback

- 1 Press the **MEMORY** button.
- 2 Press the **■** button to clear, then press the **v** button to clear all the items one by one.
- 3 Press the **▶ PLAY** button twice to resume normal playback.

NOTE:

- Some discs may not permit memory playback operation.
- To exit the Program menu, press the **MEMORY** button.
- The programmed selections will be cleared when you open the disc tray or turn off the DVD player.

CD Programmed Playback

1. Press the **MEMORY** button in PLAY/STOP mode. A screen will be shown as right.
2. Press the **>** button to highlight track. Press the **^** or **v** button to choose the desired track.
3. Press the **ENTER** button to confirm. The highlight bar will move to the next item automatically.
4. Repeat step 2 to add additional tracks.

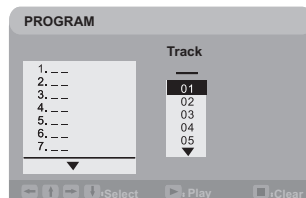
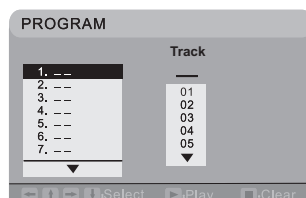

VIEWING JPEG FILES

This unit can play JPEG files written to CD-R/RW discs.

Viewing JPEG Files

1. Open the disc tray.
2. Place a disc onto the disc tray with the label side up.
3. Close the disc tray. Slide show starts automatically.
4. Press the **■** button to display a folder list. Press the **▲** or **▼** button to select your desired file, the selected picture will appear in the lower left corner.
5. Press the **▶** **PLAY** button to start playback.

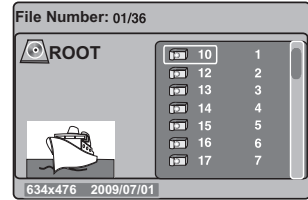

NOTE:

- You can press the **⏸** **PAUSE** button to freeze the picture, and press the **▶** **PLAY** button to resume slide show.
- You can press the **■** button to quit playback.
- You can use the number buttons on the remote control to jump immediately to the desired picture.
- You can press the **ANGLE** button on the remote control to rotate direction of the picture by 90°.
- Some discs may not permit this operation.

Repeating

1. While the picture is playing, press the **REPEAT** button until the **Track** indicator displays on the screen. The current track is played repeatedly.
2. While the picture is playing, press the **REPEAT** button again, the **Folder** indicator displays on the screen. The folder is played repeatedly.
3. While the picture is playing, press the **REPEAT** button once more, the **All** indicator displays on the screen. All tracks is played repeatedly.
4. To resume normal playback, press **REPEAT** button once again, the **Off** indicator displays on the screen.

Picture Mode

While the picture is playing, press the **Picture** button repeatedly to select your preferred option (Standard, Dynamic, Soft, Personal).

CUSTOMIZING THE FUNCTION SETTINGS

Language Setup

1. In STOP mode, press the **SETUP** button.
2. Use the **▲** or **▼** button to select the option Language Setup.
3. Press the **>** or **ENTER** button to move the highlight bar on OSD Language.
4. Use the **>** or **ENTER** button to move the highlight bar, then use the **▲** or **▼** button to select your preferred language, and press the **ENTER** button to confirm.
5. Press the **<** button to go back to the previous menu. Repeat steps 3 and 4 to adjust other options.
6. To exit the SETUP MENU and return to the normal screen, simply press **SETUP** button or press the **▲** or **▼** button to highlight the Exit Setup Mode and press the **ENTER** button.



NOTE:

- Some DVDs may not play in the audio language selected. A prior language may be programmed on the disc.
- Some DVDs may not include your pre-selected language. In this case, the DVD player automatically displays disc menus consistent with the disc's initial language setting.

CUSTOMIZING THE FUNCTION SETTINGS

Video Setup

1. In STOP mode, press the **SETUP** button.
2. Use the **▲** or **▼** button to select Video Setup.
3. Press the **▶** / **ENTER** button to highlight TV Type.
4. Press the **▶** / **ENTER** button to enter.
5. Use the **▲** or **▼** button to select the desired TV type and press the **ENTER** button to confirm.
6. Press the **◀** button to go back to the previous menu.
7. To exit the SETUP MENU and return to the normal screen, simply press **SETUP** button or press the **▲** or **▼** button to highlight the Exit Setup Mode and press the **ENTER** button.

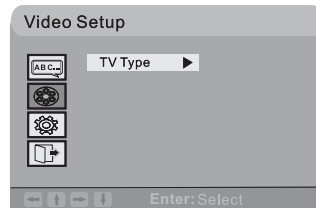

Cut off when a wide-screen video image is played.



Pan Scan



Letter Box



Wide Screen

TV Type

Pan Scan

- When wide-screen video is played, this mode clips the right and left sides of the image so that it can be viewed on a conventional screen.
- Some wide-screen DVDs that do not permit Pan Scan mode playback are automatically played in letterbox mode (black bands that appear at the top and bottom of the screen).

Letter Box

- When wide-screen video is played in this mode on a conventional screen, black bands appear at the top and bottom of the screen.

Wide Screen

- This is the correct mode for playing wide-screen videos on the unit or other external wide-screens.

NOTE:

- The displayable picture size is preset on the DVD. Therefore the playback picture of some DVDs may not conform to the picture size you select.
- When you play DVDs recorded in the 4:3 aspect ratio, the playback picture will always appear in the 4:3 aspect ratio regardless of the TV TYPE setting.
- If the screen mode is still not correct, press the **ENTER** button repeatedly to adjust it.

System Setup

1. In STOP mode, press the **SETUP** button.
2. Use the **▲** or **▼** button to select System Setup.
3. Press the **▶** / **ENTER** button to enter.
4. Use the **▲** or **▼** button to select Default item.
5. Press the **▶** / **ENTER** button to enter.
6. Use the **▲** or **▼** button to select the desired setup option and press the **ENTER** button to confirm.

NOTE: If set as Yes, it takes 3-5 seconds to reset the DVD settings to the factory default.

7. Press the **◀** button to go back to the previous menu.
8. To exit the SETUP MENU and return to the normal screen, simply press **SETUP** button or press the **▲** or **▼** button to highlight the Exit Setup Mode and press the **ENTER** button.

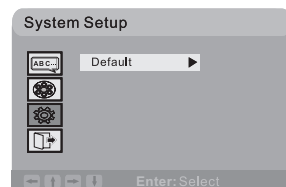

USING THE TV

Connect a TV antenna or CATV cable or Satellite system to the TV antenna terminal before searching TV channels

Scanning for TV Channels Automatically (Only appears to the first time Power On)

1. Connect the TV antenna.
2. Connect the AC power cord.
3. Press the **ON/OFF** button to turn on the unit.
4. Press the **DVD/TV/RADIO** button (the **FUNCTION** button on the remote) to select TV mode.
5. Press the **ENTER** button to proceed with auto scan.
6. Use the **<** or **>** button to select "CATV" or "AIR", then press the **ENTER** button to start auto scan.
7. The unit will immediately search all channels for those with adequate signal strength and store those channels with signals in memory. The unit will take a short minutes to finish auto scan and after this is completed, the unit will switch to the first channel found.

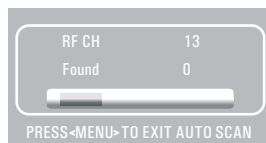
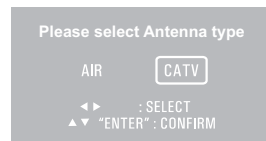
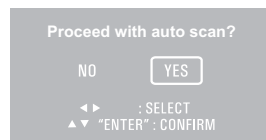

Manual Searching for TV Channels

1. Press the **TV MENU** button, then press the **>** button to TV CHANNEL SETTING.
2. Press the **✓** button to select ANTENNA. Use the **<** or **>** button to select **Air** or **CATV**.
3. Use the **✓** button to select Auto Scan.
4. Press the **ENTER** button to enter sub menu of Auto Scan.
5. Use the **✓** button to select "Start to Scan" in the sub menu.
6. Press the **ENTER** button to start the search for TV channels.
7. The screen will show the first received channel when auto search is completed.

Watching Television

Viewing a television station after the auto/manual search for channels.

1. Press the **FUNCTION** button to TV mode.
2. Press the **^ CH v** buttons to select a channel, or press the number button on the remote to select the channel you want to watch.
 - For channels 1 to 9, enter one-digit channel number.
 - For channels 10 to 99, enter the two-digit channel number.
 - For channels 100 or over, enter three-digit channel number.

NOTE:

- When a channel is selected, the channel number is displayed on the top right corner of the screen. This number will disappear after a few seconds.
- When **MUTE** is pressed, the sound is mute and the "L" indicator always blinks on the LCD display until **MUTE** is pressed again or **VOL** is pressed.

ATSC TV mode:

Press the **DISPLAY** button, the upper window will pop up, then press the **DISPLAY** button again, the lower window will pop up. Press the **DISPLAY** button once to exit.

NTSC TV mode:

Press the **DISPLAY** button, the upper window will pop up, then press the **DISPLAY** button once to exit.

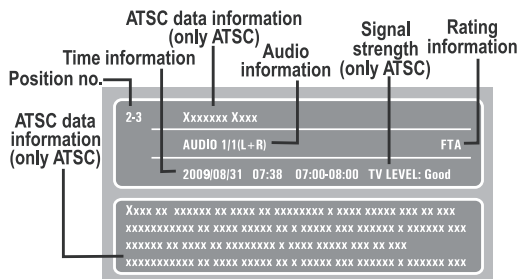

TV SETUP

Picture Setting

1. Press the **TV MENU** button.
2. Use the **▲** or **▼** button to select the options (**Picture Mode / Contrast / Brightness / Sharpness / Tint / Color**).
3. Use the **◀** or **▶** button to make adjustment. The screen will change to your selected mode immediately. Press the **TV MENU** button to return to the previous menu.
4. Repeat steps 2 and 3 to adjust other options.
5. To exit the TV SETUP MENU and return to the normal screen, press the **EXIT** button on the remote control.

NOTE: You can also access these setting by pressing the **PICTURE** button.

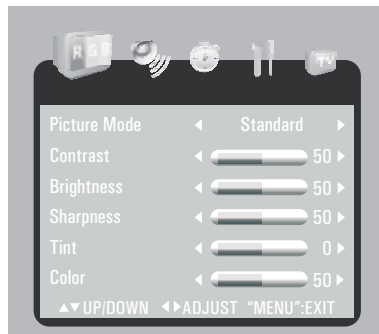

Picture Mode: Select from preset screen display settings to match the type of show you are watching (Standard, Dynamic, Soft & Personal).

Contrast: Adjust to sharpen the picture quality. The black portions of the picture become richer in darkness and the white become brighter.

Brightness: Adjust to brighten or darken the whole picture.

Sharpness: Adjust the sharpness level to improve detail in the picture.

Tint: Adjust natural skin tones in the picture quality.

Color: Adjust the color of the picture.

Sound Setting

1. Press the **TV MENU** button.
2. Use the **◀** or **▶** button to select **SOUND SETTING**.
3. Use the **▲** or **▼** button to select the options (**Sound Mode / Bass / Treble / Balance / Audio Language**).
4. Use the **◀** or **▶** button to make adjustment. Press the **TV MENU** button to return to the previous menu.
5. Repeat steps 2 to 4 to adjust other options.
6. To exit the TV SETUP MENU and return to the normal screen, press the **EXIT** button on the remote control.

NOTE: You can also access these setting by pressing the **SOUND** button.

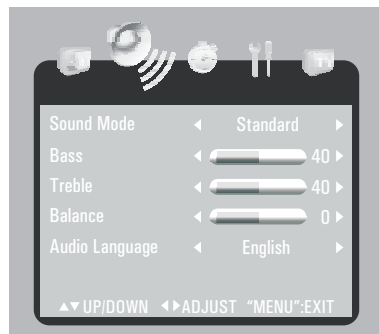

Sound Mode: Select from preset sound settings (Standard, Music, Movie, Personal) to match the type of show you are watching.

Bass: Adjust the bass range.

Treble: Adjust the treble range.

Balance: Adjust the balance level toward the left or right speakers.

Audio Language: Use the **◀** or **▶** button to select English, French or Spanish (**Available for Digital TV system only**).

NOTE: Only for DTV/ATSC input source mode, thus it is not available in other input source mode.

TV SETUP

TV Timer Setting

1. Press the **TV MENU** button.
2. Use the **<** or **>** button to select **TIMER SETTING**.
3. Use the **^** or **v** button to select the options (**OSD Duration / Time Zone / Day Saving Time**).
4. Use the **<** or **>** button to make adjustment. Press the **TV MENU** button to return to the previous menu.
5. Repeat steps 2 to 4 to adjust other options.
6. To exit the TV SETUP MENU and return to the normal screen, press the **EXIT** button on the remote control.

OSD Duration: Select amount the time of TV menu showing on screen.

Time Zone / Day Saving Time / Clock

1. Set the local Time Zone, eg. Pacific.
2. After selecting the time zone, the Day Saving Time must be activated for those areas observing such change.
3. The clock will be recorded automatically (for ATSC only).

NOTE: TV TIMER SETTING is different from the CLOCK & COOKING TIMER setting on page 15, please set both settings.

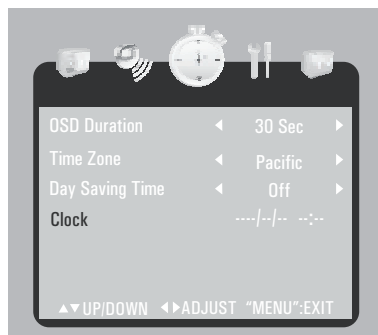

Misc Setting

1. Press the **TV MENU** button.
2. Use the **<** or **>** button to select **MISC SETTING**.
3. Use the **^** or **v** button to select the options (**Language / Color Mode / Restore Setting**).
4. Use the **<** or **>** button to make adjustment. The screen will change to your selected mode immediately. Press the **TV MENU** button to return to the previous menu.
5. Repeat steps 2 to 4 to adjust other options.
6. To exit the TV SETUP MENU and return to the normal screen, press the **EXIT** button on the remote control.

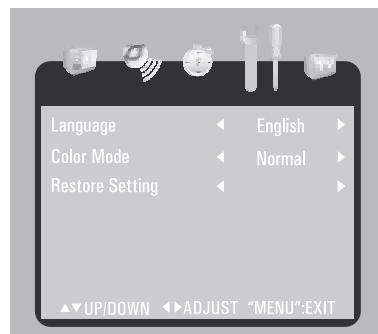

Language : Select from English / Français / Español.

Color Mode : Adjust the three color temperature of the picture. Select Normal (balanced) / Warm (red white) / Cool (blue white) mode.

Restore Setting: If you reset the TV to the factory settings, all your present settings on picture & sound will be erased and replaced by the factory's default settings.

TV SETUP

TV Channel Setting

1. Press the **TV MENU** button.
2. Use the **<** or **>** button to select TV CHANNEL SETTING.
3. Use the **^** or **v** button to select the options (**Antenna / Auto Scan / Auto Scan Add CH / Channel Skip / Channel No. / Channel Label**).
4. Use the **<** or **>** button to make adjustment. The screen will change to your selected mode immediately. Press the **TV MENU** button to return to the previous menu.
5. Repeat steps 2 to 4 to adjust other options.
6. To exit the TV SETUP MENU and return to the normal screen, press the **EXIT** button on the remote control.

NOTE: Channel No. : 2-69 Channel for Air, 1-135 Channel for CATV.

Antenna : Select "CATV" to receive cable signal. Select "AIR" to receive air signal.

Auto Scan : Automatically search all channels for those with adequate signal strength.

Auto Scan Add CH: The stored channels can not be cleared and the Auto Scan Channels will be added.

If you have selected CATV in TV CHANNEL SETTING, then you can select Cable System (AUTO / STD / HRC / IRC) in the sub menu as the picture shown.

Channel Skip: You may switch ON/OFF the skip function of each stored channel by selecting the channel with **^** or **v** button (and using **<** or **>** button to select page if the amount of stored channels in more than 1 page), and followed with pressing the **ENTER** button.

Channel Label: You may edit one label for each channel.

1. Select the Channel Label item and press the **<** or **>** button to go into the channel label edit screen.
2. Use the **^** or **v** button to enter the number or letter.
3. Use the **<** or **>** button to move and edit for the next character.
4. After editing, press the **DISPLAY** button and the Channel & Channel Label will be shown on the screen.

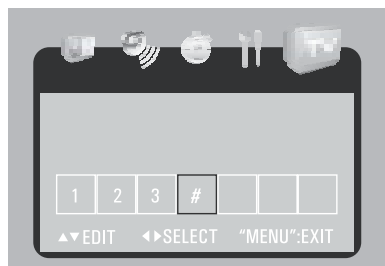
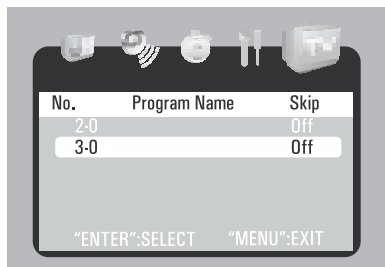
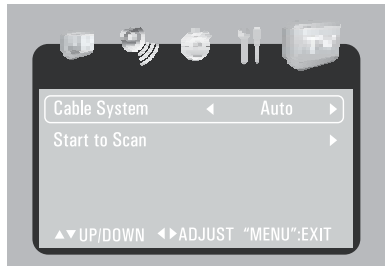
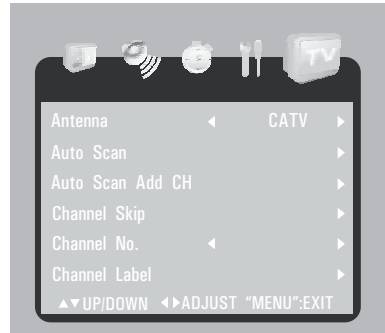

LISTENING TO THE RADIO

Tuning in to a Station Manually

1. Press the **DVD/TV/RADIO** button (the **FUNCTION** button on the remote control) until the radio frequency appears on the front panel display.
 2. Press the **■/AM/FM** button to select AM or FM.
 3. Press the **◀◀ TUNING ▶▶** buttons on the remote control to tune in to a desired station.
- When **MUTE** is pressed, the sound is mute and the “L  ” indicator always blinks on the LCD display until **MUTE** is pressed again or **VOL** is pressed.

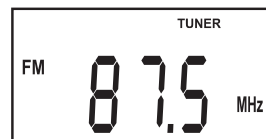

FM Stereo

Press the **MTS** button on the remote control until “5t” appears on the front panel display.

Weak FM stations

Press the **MTS** button on the remote control until “1CH” appears on the front panel display. Background noise will be reduced. To restore stereo reception, press the **MTS** button on the remote control to select “5t”.

Searching for a Station Automatically

- Press and hold the **◀◀ CH ∇ / ▶▶ CH ▲** button on the front panel or the **◀◀ TUNING ▶▶** buttons on the remote control until the tuner starts searching for a station, then release. After tuning in a station, the search stops.
- The search may not stop at a station with a very weak signal.

Presetting Stations

The unit can store a total of 60 stations in memory (30 FM, 30 AM). Presetting allows you to tune in to a station directly.

1. Press the **DVD/TV/RADIO** button (the **FUNCTION** button on the remote control) to RADIO.
2. Press the **■/AM/FM** button to select AM or FM.
3. Press the number button on the remote control to select the preset number.
 - For preset numbers 1 to 9, simply press the number button on the remote control.
 - For preset numbers 10 to 30, enter the two-digit numbers.
For example, to enter 18 by pressing “1” & “8”.
4. Press the **◀◀ TUNING ▶▶** buttons to tune in to a desired station.
5. Press the **MEMORY** button twice on the remote control.
6. Repeat steps 2-5 to store other stations.

Tuning in to a Preset Station

1. Press the **DVD/TV/RADIO** button (the **FUNCTION** button on the remote control) to RADIO.
2. Press the **■/AM/FM** button to select AM or FM.
3. Press the **◀◀ PREV / ▶▶ NEXT** button repeatedly to select the number of the preset station or use the numeric buttons to enter the number of the preset station.

For Better Reception

FM: Fully unwind the FM antenna wire. Then extend the FM antenna wire and place it in the position that sounds best.

AM: Fully unwind and rotate the loop antenna then position it for the best reception.

NOTE: Do not connect the FM antenna to an outside antenna.

TROUBLESHOOTING GUIDE

SYMPTOM	CAUSE (AND REMEDY)
No power.	<ul style="list-style-type: none"> • Ensure the AC power cord is connected. • The unit is not turned on.
The remote control does not function.	<ul style="list-style-type: none"> • Remove any obstacles between the remote control and the unit. • Use the remote control near the unit. • Point the remote control at the remote sensor on the unit. • Replace all batteries in the remote control with new ones.
DVD No sound or only a very low-level sound is heard.	<ul style="list-style-type: none"> • Make sure that you've selected DVD mode. • The system is in pause mode. Press the ► PLAY button to return to normal play mode. • Fast forward or fast reverse is performed. Press the ► PLAY button to return to normal play mode. • The DTS DVD cannot be decoded to have speaker output. • This unit is too hot. Shut off the unit for 30 minutes to allow it to cool down.
No picture	<ul style="list-style-type: none"> • The region number of the disc doesn't match the region number of this unit. 
The picture is not clear	<ul style="list-style-type: none"> • Clean the disc. • The disc is scratched.
Severe hum or noise is heard.	<ul style="list-style-type: none"> • Clean the disc.
The disc does not play.	<ul style="list-style-type: none"> • There is no disc inside ("No Disc" appears on the screen). • Insert the disc correctly with the label side facing up on the disc tray. • Clean the disc. • A non-NTSC disc has been inserted. The unit and disc region number are incompatible. • Condensation may have formed inside the unit due to a sudden change in temperature. Wait about an hour for it to clear and try again.
TV Snowy picture, multiple image, picture distorted, picture blurred and noisy sound.	<ul style="list-style-type: none"> • Check antenna location, direction or connection.
No color of picture.	<ul style="list-style-type: none"> • Check the PICTURE SETTING in the TV SETUP MENU.
No picture and sound.	<ul style="list-style-type: none"> • Not plugged into AC outlet. • Make sure that you've selected TV mode. • Try a new channel to check for possible station trouble. • Make sure the antenna is connected to properly. • Increase the volume. • The antenna is broken. • Check for local interference.
Colored patches of picture.	<ul style="list-style-type: none"> • Magnetic interference from unshielded equipment. • Turn OFF the unit for 30 minutes, then turn ON again.

MAINTENANCE

Cleaning the Disc

A defective or soiled disc inserted into the unit can cause sound to drop out during playback. Handle the disc by holding its inner and outer edges.

- Do NOT touch the surface of the unlabeled side of the disc.
- Do NOT stick paper or tape on the surface.
- Do NOT expose the disc to direct sunlight or excessive heat.
- Clean the disc before playback. Wipe the disc from the center outward with a cleaning cloth.
- NEVER use solvents such as benzine or alcohol to clean the disc.
- Do NOT use irregular shaped discs (example: heart shaped, octagonal, etc.). They may cause malfunctions.

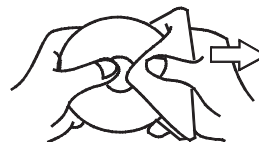

Cleaning the Unit

Clean plastic cover over screen if it becomes dirty with oil, grease, dust, etc while cooking. Please follow below steps.

- Be sure to turn the unit off and disconnect the AC power cord before cleaning the unit.
- Wipe the unit with a dry soft cloth. If the surfaces are extremely dirty, wipe clean with a cloth that has been dipped in a weak soap-and-water solution and wrung out thoroughly. Then wipe with a dry cloth.
- Never use alcohol, benzine, thinner, cleaning fluid or other chemicals. Do NOT use compressed air to remove dust.

Important Note

Before transporting the unit, remove the disc from the disc compartment.

SPECIFICATIONS

Power source: AC 120V ~ 60Hz

Specifications and external appearance are subject to change without notice.

Printed in China
811-397391W012

Free Manuals Download Website

<http://myh66.com>

<http://usermanuals.us>

<http://www.somanuals.com>

<http://www.4manuals.cc>

<http://www.manual-lib.com>

<http://www.404manual.com>

<http://www.luxmanual.com>

<http://aubethermostatmanual.com>

Golf course search by state

<http://golfingnear.com>

Email search by domain

<http://emailbydomain.com>

Auto manuals search

<http://auto.somanuals.com>

TV manuals search

<http://tv.somanuals.com>