

RCA

USER'S GUIDE

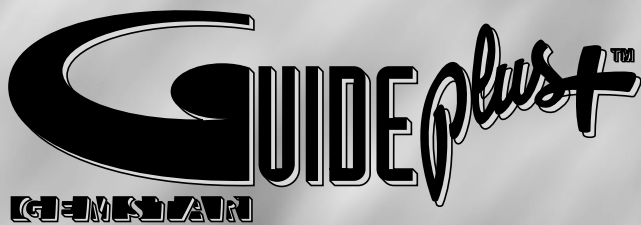

tv/vcrtv/vcrtv/vcrtv/vcrtv/vcrtv/v
crtv/vcrtv/vcrtv/vcrtv/vcrtv/vcrtv
/vcrtv/vcrtv/vcrtv/vcrtv/vcrtv/vcr
tv/vcrtv/vcrtv/vcrtv/vcrtv/vcrtv/v
crtv/vcrtv/vcrtv/vcrtv/vcrtv/vcrtv
/vcrtv/vcrtv/vcrtv/vcrtv/vcrtv/vcr/
tv/vcrtv/vcrtv/vcrtv/vcrtv/vcrtv/v
crtv/vcrtv/vcrtv/vcrtv/vcrtv/vcrtv
/vcrtv/vcrtv/vcrtv/vcrtv/vcrtv/vcr/
tv/vcrtv/vcrtv/vcrtv/vcrtv/vcrtv/v
crtv/vcrtv/vcrtv/vcrtv/vcrtv/vcrtv
/vcrtv/vcrtv/vcrtv/vcrtv/vcrtv/vcr
tv/vcrtv/vcrtv/vcrtv/vcrtv/vcrtv/v
crtv/vcr
v/vcrtv
vcrtv/
vcrtv/
rtv/vcr
/vcrtv/vc
v/vcrtv/
rtv/vcr
/vcrt
vcr

A black and white photograph of two dogs. On the left is a larger dog, possibly a Weimaraner, with white fur and dark ears and face markings. On the right is a smaller dog, possibly a Chihuahua, with white fur and dark markings. Both dogs are wearing dark collars and looking directly at the camera.

tv/vcrt
/vcrtv/
vcrtv/
vc
tv
rt
vc
tv
v/
tv

IMPORTANT INFORMATION

WARNING

To reduce the risk of fire or electric shock, do not expose this product to rain or moisture.

WARNING

RISK OF ELECTRIC SHOCK
DO NOT OPEN

To reduce the risk of electric shock, do not remove cover (or back). No user-serviceable parts inside. Refer servicing to qualified service personnel.



This symbol indicates "dangerous voltage" inside the product that presents a risk of electric shock or personal injury.



This symbol indicates important instructions accompanying the product.

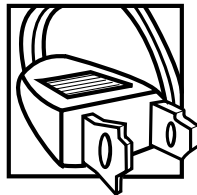

Caution: To prevent electric shock, match wide blade of plug to wide slot, fully insert.

Attention: Pour éviter les chocs électriques, introduire la lame la plus large de la fiche dans la borne correspondante de la prise et pousser jusqu'au fond.

Refer to the identification/rating label located on the back panel of your product for its proper operating voltage.

FCC Regulations state that unauthorized changes or modifications to this equipment may void the user's authority to operate it.

If fixed (non-moving) images are left on the screen for long periods, they may be permanently imprinted on the picture tube. Such images include network logos, phone numbers, and video games. This damage is not covered by your warranty. Extended viewing of channels displaying these images should be avoided.

Cable TV Installer: This reminder is provided to call your attention to Article 820-40 of the National Electrical Code (Section 54 of the Canadian Electrical Code, Part 1) which provides guidelines for proper grounding and, in particular, specifies that the cable ground shall be connected to the grounding system of the building as close to the point of cable entry as practical.

Product Registration

Please fill out the product registration card and return it immediately. Returning the card allows us to contact you if needed.

Keep your sales receipt to obtain warranty parts and service and for proof of purchase. Attach it here and record the serial and model numbers in case you need them. The numbers are located on the back of the product.

Model No. _____

Serial No. _____

Purchase Date: _____

Dealer/Address/Phone: _____

G-LINK, VCR Plus+, C³, PlusCode, and GUIDE Plus+ are trademarks of Gemstar Development Corporation.

The GUIDE Plus+ system is manufactured under license from Index Systems Inc.

Thomson Consumer Electronics and Gemstar are not in any way liable for the accuracy of the program information provided by the GUIDE Plus+ System. In no event shall Thomson Consumer Electronics or Gemstar be liable for any amount representing loss of profits, loss of business, or indirect, special, or consequential damages in connection with the provision or use of any information equipment, or services relating to the GUIDE Plus+ System.

TABLE OF CONTENTS

SETUP AND CONNECTIONS	3
Step 1: Unpack the TV/VCR and Remote Control	4
Step 2: Insert Batteries in the Remote	4
Step 3: Place your TV/VCR on a Stable Surface	4
Step 4: Choose a Hookup	4
How to Hook Up a VCR or Camcorder	5
Connection A: Attaching to a Dipole Antenna (With No Cable Box)	5
Connection B: Attaching to an Outside Antenna, Set-top Antenna, or Cable System (With No Cable Box) ..	5
Connection C: Attaching to a Cable Box Required to Unscramble All Channels	6
Connection D: Attaching to a Cable Box Required to Unscramble Premium Channels Only	6
Connection E: Attaching to a VCR for Copying Tapes	7
Connection F: Attaching a Camcorder for Copying Tapes	7
Step 5: Connect the G-LINK Cable	8
Find the Remote Control Sensor	8
Step 6: Plug in the TV/VCR	9
Step 7: Turn on the TV/VCR.....	9
Step 8: Set Up the GUIDE Plus+ System	9
Step 9: Set Up the Rest of the TV/VCR	12
Select the Language	12
Put Channels into Memory (Auto Channel Search)	12
Set the Signal Type (Optional)	13
Add or Remove Channels from the TV/VCR's Memory	13
Set the Time and Date (Clock).....	14
USING THE REMOTE	15
Remote Control Buttons	16
Programming the Remote	18
Using the Remote to Control a Device	19
Modes of Operation	19
OPERATING INSTRUCTIONS	21
How to Play a Tape	22
Using the Playback Features	23
Recording Features	28
Basic Recording	29

TABLE OF CONTENTS

Express Recording	29
Timer Recording	30
Copying and Editing Tapes	31
FEATURES AND CONTROLS	33
Using On-Screen Displays	34
Calling Up On-Screen Displays	34
Adjusting the Video	34
About Closed Captioning	35
To View Closed Captions	35
Using Sleep Timer	36
Wake-Up Timer	36
Parental Controls and V-Chip	38
Setting TV Rating Limits	39
Blocking Age-Based Ratings	40
Viewing Age-Based Ratings	40
Blocking Specific Content Themes	41
Viewing Specific Content Themes	41
Setting Movie Rating Limits	42
Blocking Movie Ratings	42
Viewing Movie Ratings	42
Blocking Unrated TV Programs	43
Lock/Unlock Parental Controls	43
Using the GUIDE Plus+ System	44
Getting In & Out of the GUIDE Plus+ System	45
Downloading Data	45
Channel Mapping	45
The Different GUIDE Plus+ System Menus	45
Grid Guide	45
Sort	47
REFERENCE	51
Front Panel	52
Back Panel	53
Troubleshooting	53
Cleaning the TV/VCR	56
Limited Warranty	57
Index	61

SETUP AND CONNECTIONS

GETTING STARTED

This manual is designed to help you get started quickly. The first sections of the manual show you how to get setup and connected, program the remote, and use your TV/VCR. It also guides you through all of the menus, features, and controls of your TV/VCR.

The reference section in the back of the book contains troubleshooting tips, care and cleaning instructions, accessory ordering information, and our warranty.

Well...if your TV/VCR is out of the box, let's get started.

1 SETUP AND CONNECTIONS



2 USING THE REMOTE



3 OPERATING INSTRUCTIONS



4 FEATURES AND CONTROLS



5 REFERENCE

SETUP AND CONNECTIONS

STEP 1: UNPACK THE TV/VCR AND REMOTE CONTROL

Contact your dealer if your remote control is missing.

STEP 2: INSERT BATTERIES IN THE REMOTE

1. Remove the battery compartment cover from the back of the remote.
2. Insert fresh batteries. Make sure that the polarities (+ and -) are aligned correctly.
3. Replace the cover.

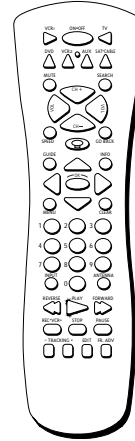

STEP 3: PLACE YOUR TV/VCR ON A STABLE SURFACE

CAUTION: To reduce the risk of personal injury or damage to the TV/VCR, take care in selecting a surface or stand on which to place your product and when moving or carrying it. Use a stable surface or a strong steady stand and a location where the TV/VCR cannot be tipped over or easily pulled off, particularly by children. Do not attempt to carry or move this product with one hand. Grasp the TV/VCR with both hands with the TV front against your body to prevent it from slipping out of your grasp.

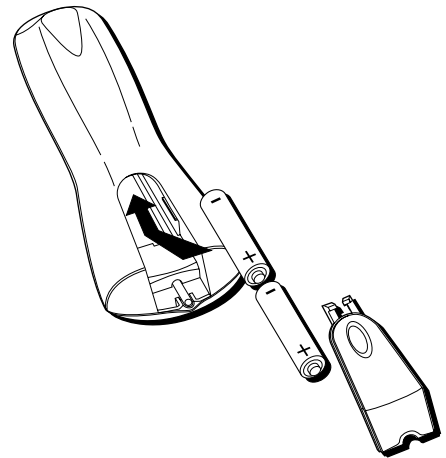

STEP 4: CHOOSE A HOOKUP

Answer the questions to choose the appropriate hookup for your TV/VCR.

1. How does your TV/VCR receive signals?

Choose one answer from below.

- Dipole antenna – Use Connection A.
- Outside antenna – Use Connection B.
- Cable System – Go to question 2.

2. What type of Cable-TV system* do you have?

Choose one answer from below.

- Cable without a box – Use Connection B.
- Cable box to unscramble all channels – Use Connection C.
- Cable box to unscramble only premium channels, such as HBO, Showtime, Cinemax, etc. – Use Connection D.

*You may need to contact your local cable company for assistance.

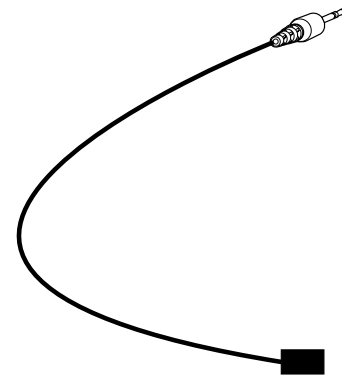

G-LINK Cable

Please locate the G-LINK cable (provided) when you're getting ready to set up your TV/VCR. You need to use this cable to connect your TV/VCR to your cable box (if you have one) in order for all of the features of the program guide to work properly.

SETUP AND CONNECTIONS

HOW TO HOOK UP A VCR OR CAMCORDER

To hook up a VCR or camcorder for copying tapes, use Connection E or F.

CONNECTION A:

Attaching to a Dipole Antenna (With No Cable Box)

Follow these steps to connect a dipole antenna to your TV/VCR. Do not connect a dipole antenna if you plan to connect a different type of indoor or outdoor antenna or cable system. Optional accessories may be required for this connection.

1. Insert the antenna base into the slot on the back of your TV/VCR.
2. Connect the twin-lead ends of the antenna to the screw terminals of an antenna adapter.
3. Connect an antenna adapter to the IN FROM ANTENNA jack on the back of the TV/VCR.
4. Plug the TV/VCR power cord into the back of the TV/VCR.
5. Go to "Step 5: Connect the G-LINK Cable."

Once you have plugged in your TV/VCR, adjust the length and position of the antenna rods for the best reception. For viewing VHF channels, extend the rods fully. For UHF viewing, shorten the rods.

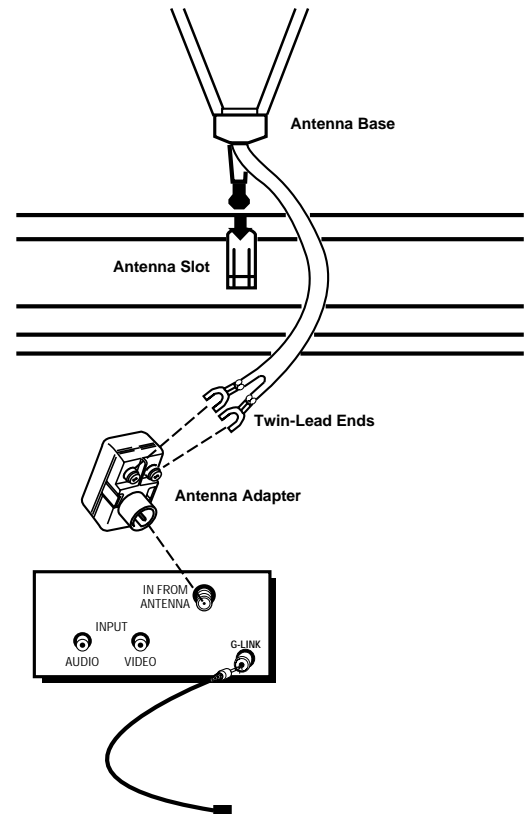

CONNECTION B:

Attaching to an Outside Antenna, Set-top Antenna, or Cable System (With No Cable Box)

1. Connect as shown. Optional accessories may be required for this connection.
2. Plug the TV/VCR power cord into the back of the TV/VCR.
3. Go to "Step 5: Connect the G-LINK Cable."

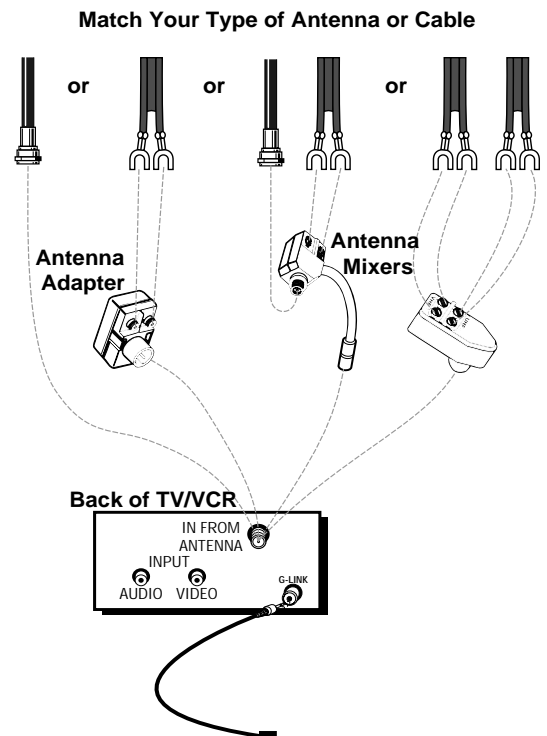

SETUP AND CONNECTIONS

CONNECTION C:

Attaching to a Cable Box Required to Unscramble All Channels

1. Connect as shown. Optional accessories may be required for this connection.
2. Plug in power cords of TV/VCR and cable box.
3. Go to "Step 5: Connect the G-LINK Cable."

CONNECTION D:

Attaching to a Cable Box Required to Unscramble Premium Channels Only

1. Connect as shown. Optional accessories may be required for this connection.
2. Plug in power cords of TV/VCR and cable box.
3. Place the A-B switch in the B position to watch premium channels. Place the A-B switch in the A position to watch other channels when cable box is not needed.
4. Go to "Step 5: Connect the G-LINK Cable."

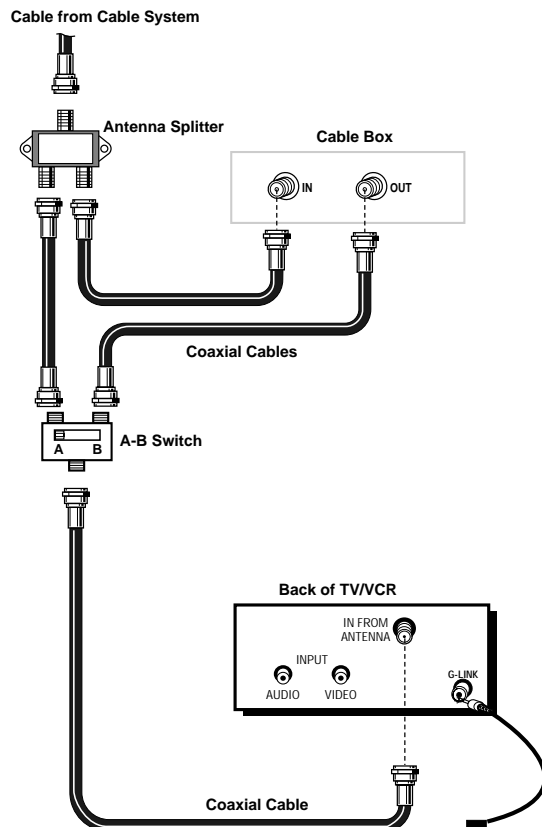
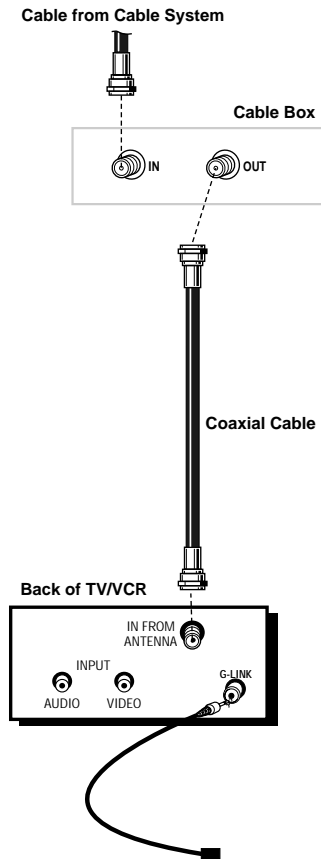

In order for the cable box to properly work with your TV/VCR, you must complete "Step 8: Set Up the GUIDE Plus+ System," later in this section.

SETUP AND CONNECTIONS

CONNECTION E:

Attaching to a VCR for Copying Tapes

1. Connect as shown. Optional accessories may be required for this connection.
2. Plug in power cords of VCR and TV/VCR.
3. For further instructions, see the section "Copying and Editing Tapes."

Press 00 on the remote to select the line (audio/video) inputs on the TV/VCR to receive the signal from the VCR.

If your VCR has stereo AUDIO OUT jacks, connect the audio cable to the jack labeled MONO. If neither jack is labeled MONO, you may need a Y-adaptor to hear both channels.

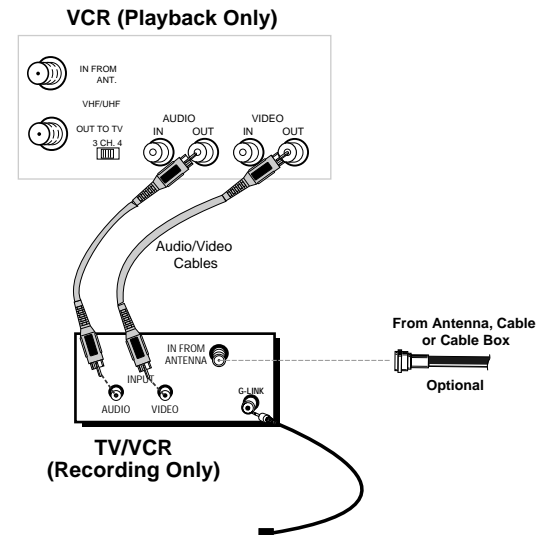

CONNECTION F:

Attaching a Camcorder for Copying Tapes

1. Connect as shown. Optional accessories may be required for this connection.
2. Plug in TV/VCR's power cord.
3. For further instructions, see the section "Copying and Editing Tapes."

Press 00 on the remote to select the line (audio/video) inputs on the TV/VCR to receive the signal from the camcorder.

If your camcorder has stereo AUDIO OUT jacks, you may need a Y-adaptor to hear both channels.

The unauthorized recording of television programs and other materials may infringe upon the rights of others.

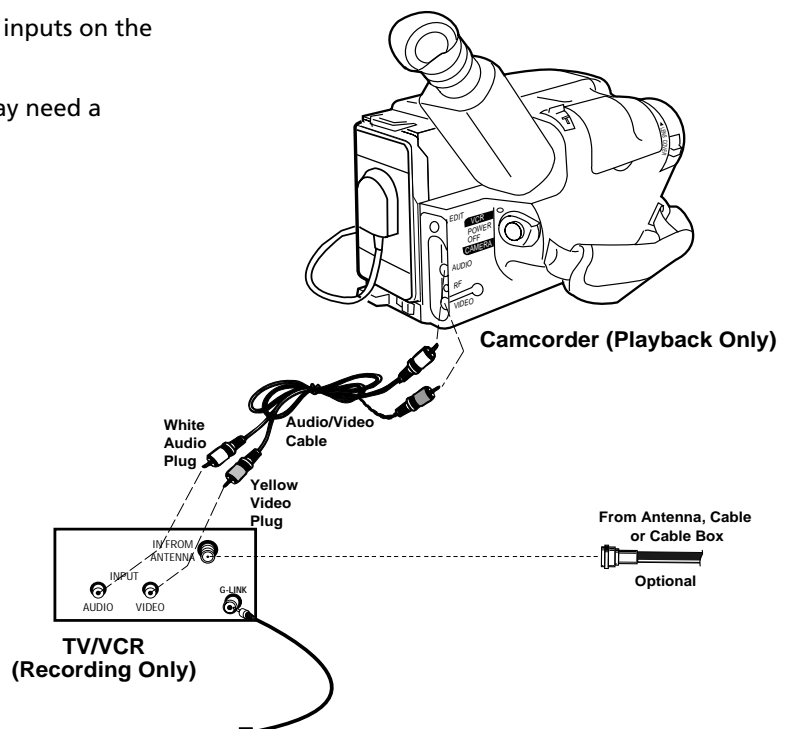

SETUP AND CONNECTIONS

STEP 5: CONNECT THE G-LINK CABLE

This is an important step because the G-LINK cable enables your TV/VCR and the GUIDE Plus+ system (the on-screen guide that lists what shows are on TV) to work with your cable box. The G-LINK cable will not work until the GUIDE Plus+ system is set up. (Setting up the GUIDE Plus+ system is explained in "Step 8: Set Up the GUIDE Plus+ System," later in this section.)

If you do not have a cable box, you do not have to connect the cable. If your TV is connected to a cable box, you must connect the G-LINK cable to your cable control box, complete the TV/VCR menu setup, and activate auto-programming. Unless you complete these steps, no channels will be listed in the on-screen program guide and your TV will not work properly.

FIND THE REMOTE CONTROL SENSOR

You have to attach the G-LINK cable's end to the remote control sensor on the cable box. Some cable boxes have a label attached to it that identifies the remote control sensor. If the remote sensor isn't labeled on your cable box, you need to use the remote control that came with the cable box to locate the sensor. To do this:

1. Turn off the cable box.
2. Hold the remote control (**not** the one that came with your TV/VCR, but the one that **came with** the cable box) so it is touching the front of the component.
3. Slowly move the remote control across the front of the cable box while you press the power button on and off. You must press and release the power button each time you move the remote (holding down the button won't work).

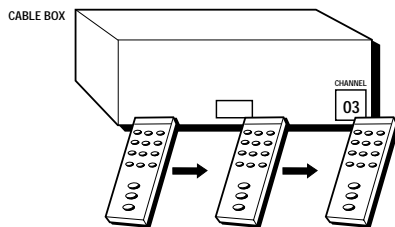

4. When the cable box turns on, you've located the remote control sensor.
5. Attach the end of the G-LINK cable to your cable box (see instructions below).

ATTACH THE END TO THE CABLE BOX

Attach the end of the G-LINK cable to your cable box as shown in the illustration to the right.

Note that you must remove the demo pin from the G-LINK jack on the back of the TV/VCR before inserting the G-LINK cable.

Tip

You may want to use a piece of clear plastic tape to temporarily affix the G-LINK cable end until you have completed the connection. That way you can easily move it if you have not placed it correctly over the sensor.

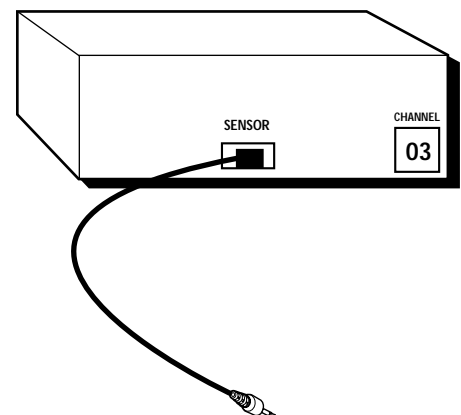

Connect to G-LINK jack on the back of the TV/VCR.

SETUP AND CONNECTIONS

STEP 6: PLUG IN THE TV/VCR

Plug the power cord into the wall outlet, matching the wide blade of the plug with the wide slot in the outlet. Be sure to insert the plug completely.

STEP 7: TURN ON THE TV/VCR

Press POWER on the front of the TV/VCR or press TV or VCR on the remote. The indicator in the POWER button on the front of the TV/VCR will light when the TV/VCR is on.

The first time you turn on the TV/VCR, you will be asked to set up the GUIDE Plus+ system.

STEP 8: SET UP THE GUIDE Plus+ SYSTEM

You can set up the GUIDE Plus+ system to display your local program listings and control your cable box. If you are using a cable box and do not set up the GUIDE Plus+ system, your TV/VCR will not work properly.

The GUIDE Plus+ Setup appears when you turn on your TV/VCR for the first time.

- The GUIDE Plus+ system is the on-screen guide that lists what shows are on TV in your area. In order to get program information, you need to set up the GUIDE Plus+ information.
- The G-LINK cable must be connected to the back of your TV/VCR, and the other end must be attached to your cable box (if you have one) in order for the GUIDE Plus+ Setup to work.

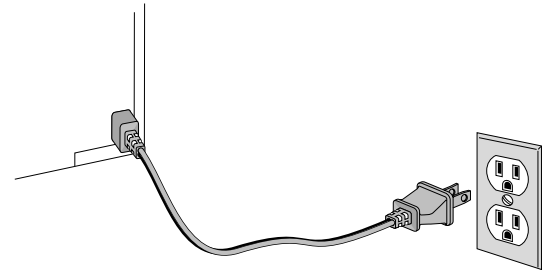

If you move or if any of your information changes:

1. Return to the GUIDE Plus+ setup and reinitialize the setup to indicate that you are no longer using a cable box. (You must clear the previous channel lock before re-setting the TV/VCR.)
2. Press MENU on the remote to display the TV/VCR Main Menu.
3. Press 5, then 1 to initiate Auto Channel Search.
4. When the Auto Channel Search is complete, press MENU.
5. Press 6, then 1 to create a new setup. (See "Step 8: Set Up the GUIDE Plus+ System," at left, for more details.)

SETUP AND CONNECTIONS

To complete GUIDE Plus+ setup, the G-LINK cable must be properly attached to your cable box if you have one. See "Step 5: Connect the G-LINK Cable," later in this section.

Select your country and enter your ZIP or Postal code. For Canada, use CH ^ and v to select letters.

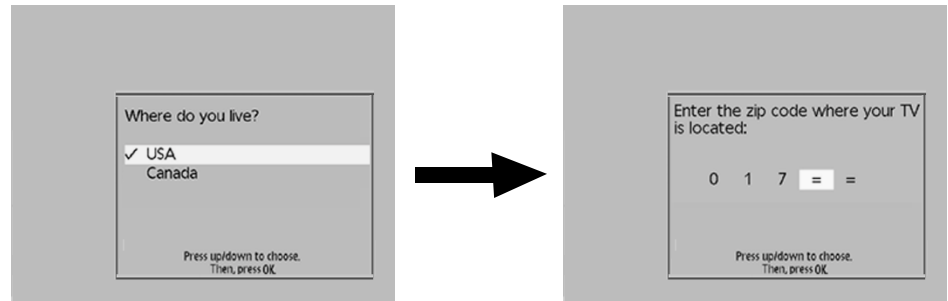

The next series of screens asks you about your cable TV setup. If you have a cable box, you must set the GUIDE Plus+ system to control it. Otherwise, it will not be able to locate and download program information.

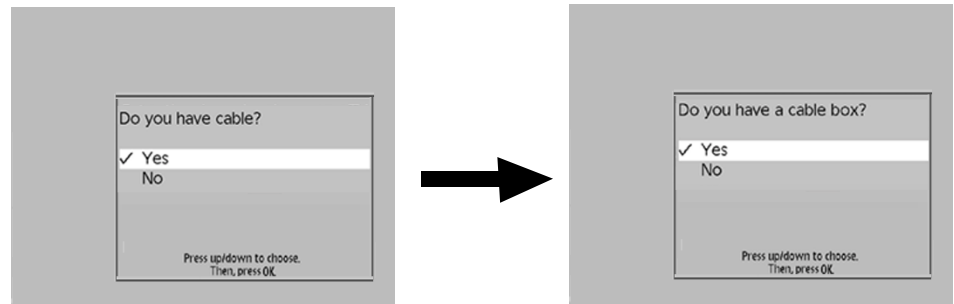

Tune your cable box to Channel 2 and then select the brand of your cable box from the choices available. The system then searches for the correct code to control your cable box. When your cable box switches to channel 9 it has located the correct code.

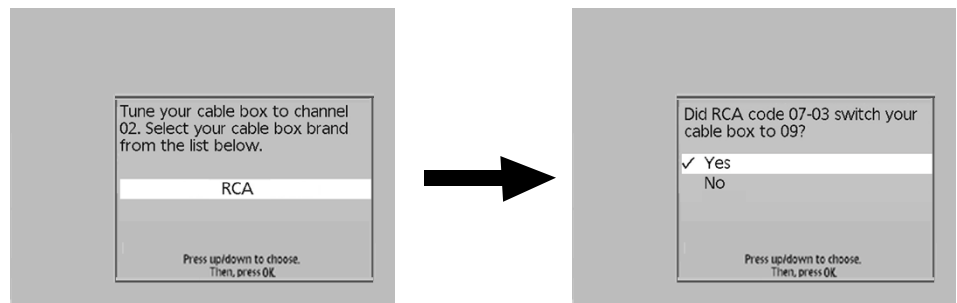

Select *Yes* if the cable box changed to channel 9, or *No* if it did not. If you select *No*, the system will try another code. If the GUIDE Plus+ system cannot recognize your cable box after several tries, a screen stating "Cable Box test failed...Please consult your manual and try again" appears. Choose either *Try Again* or *Skip Cable Box Setup*. If you get this message, you should also:

- Double check the brand of your cable box, and try entering it again.
- Check to make sure the G-LINK cable is attached correctly.

If you choose to skip the cable box setup some features of the guide may not be available until you successfully complete this procedure.

SETUP AND CONNECTIONS

Once the correct model of cable box has been identified, you need to set the cable box's output channel. Enter the channel you use to view channels through your cable box—usually 3 or 4. Consult your cable box's instruction book or your cable company if you are not sure. Choose 0 to use VIDEO INPUT.

The last screen comes up when you've successfully finished the GUIDE Plus+ setup.

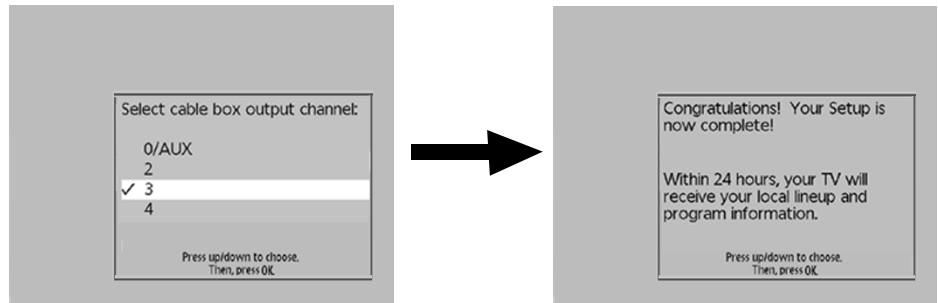

Remember:

- Leave your cable box turned ON to download program information. Downloading may take 24 hours.

Press OK to leave the GUIDE Plus+ Setup and return to the TV's Main Menu. See the section "Features and Controls" for more details about the GUIDE Plus+ system.

To Get Out of the GUIDE Plus+ System:

- Press OK to exit the GUIDE Plus+ system and tune to the highlighted channel.
- Press GUIDE to exit the GUIDE Plus+ system and tune to the channel displayed in the background.
- Press CLEAR to exit the GUIDE Plus+ system and go to the last channel you were watching.

SETUP AND CONNECTIONS

STEP 9: SET UP THE REST OF THE TV/VCR

Select the Language

This feature lets you select English, Spanish, or French as the language for your on-screen displays.

1. Press MENU on the remote to display the TV/VCR Main Menu.
2. Press 1 to display the Screen menu.
3. Press 3 to toggle the menu language between English, Spanish and French. The default menu language when you first turn on the TV/VCR is English.

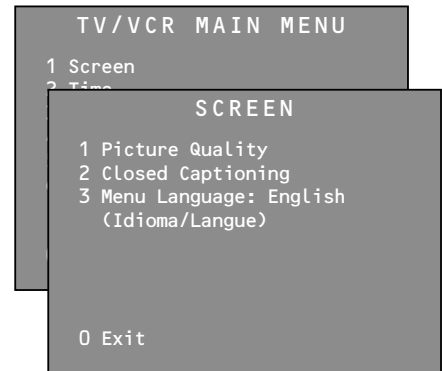

Put Channels into Memory (Auto Channel Search)

1. Press MENU on the remote to display the TV/VCR Main Menu.
2. Press 5 to display the Setup menu.
3. Press 1 to start Auto Channel Search.
4. Allow the TV/VCR to search for all channels. Pressing any buttons during Auto Channel Search will stop the search and only some channels will be in the TV/VCR's memory. When the search is finished the TV/VCR will automatically tune to the first channel in the channel memory list.

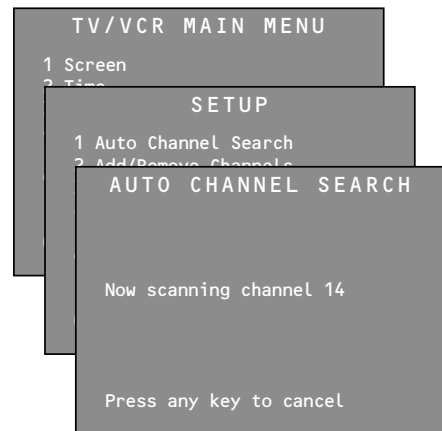

SETUP AND CONNECTIONS

Set the Signal Type (Optional)

Note that if you have set up the GUIDE Plus+ system, Signal Type will not be available.

The TV/VCR automatically selects the signal type (cable or antenna) when you run the Auto Channel Search. If you want to change the signal type, follow the directions below.

1. Press MENU on the remote to display the TV/VCR Main Menu.
2. Press 5 to display the Setup menu.
3. Press 5 to toggle the Signal Type between Antenna and Cable.
 - After changing the Signal Type, you may need to re-enter the channel number you are trying to receive.
 - After changing the Signal Type, you may need to run the Auto Channel Search again.

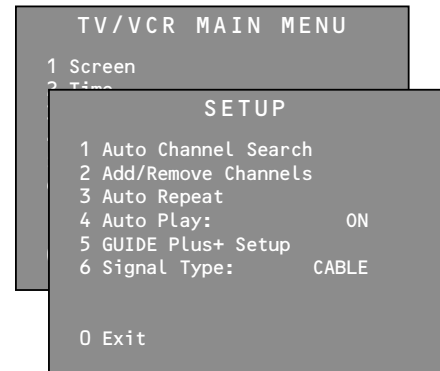

Add or Remove Channels from the TV/VCR's Memory

This feature is not available if you are using a cable box and have set up the GUIDE Plus+ system, regardless of whether or not you use the GUIDE Plus+ system.

1. Press MENU on the remote to display the TV/VCR Main Menu.
2. Press 5 to display the Setup menu.
3. Press 2 to display the Add/Remove Channels screen.
4. Follow the directions on the screen to add or remove a channel.
5. Add or remove more channels by entering the channel number or pressing CH ^ or v.

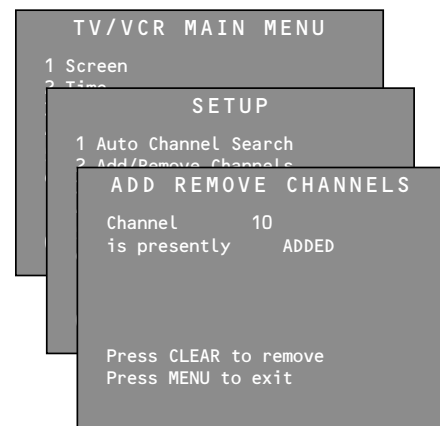

SETUP AND CONNECTIONS

Set the Time and Date (Clock)

Note that if you have set up the GUIDE Plus+ system, the Time menu will not appear. Note that the only time you need to set the clock is when you're not using cable (or a cable box). To set the clock:

1. Press MENU on the remote to display the TV/VCR Main Menu.
2. Press 2 to display the Time menu.
3. Press 1 to display the Set Time and Date screen.
4. Use the number buttons on the remote to enter the time.
 - Press 0 before 1; 0 is added automatically before all other numbers. Press 1 for AM or 2 for PM. Example: For a time of 1:07 PM, press 0, then 1, then 0, then 7, then 2.
5. Use the number buttons on the remote to enter the date.
 - The day of the week will automatically appear after you enter the year.
 - Press CLEAR on the remote at any time to change incorrect entries.
6. Press MENU on the remote to start the clock.

To exit and return to TV viewing, follow the on-screen instructions.

To display the time and date, press INFO on the remote.

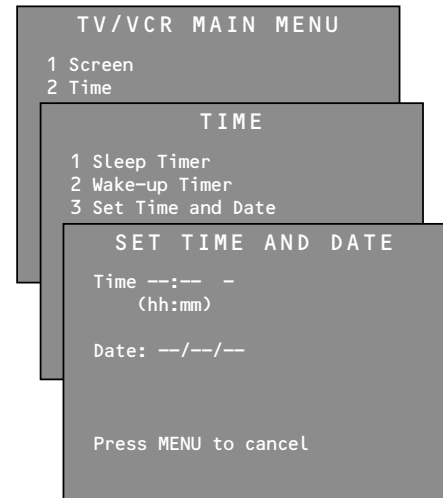

If you have set up the GUIDE Plus+ system, the Time menu will not appear.

USING THE REMOTE

USING YOUR UNIVERSAL REMOTE

This section defines the buttons of the remote and how to program it to control other components.

The universal remote can be programmed to control most brands of remote-controllable VCRs, satellite receivers, and cable boxes. If you have an RCA, GE, or PROSCAN component, you probably don't need to program it at all.

1 SETUP AND CONNECTIONS



2 USING THE REMOTE



3 OPERATING INSTRUCTIONS



4 FEATURES AND CONTROLS



5 REFERENCE

USING THE REMOTE

REMOTE CONTROL BUTTONS

ON•OFF When in TV/VCR mode, turns the TV/VCR on and off. If in another device mode (VCR, DVD, Satellite, etc.) and programmed, will turn the device on and off. When pressed twice within two seconds, all devices that are on will be turned off (this feature only works with most RCA, GE, and PROSCAN products).

VCR1 Puts the remote in VCR mode.

TV Turns on the TV/VCR and puts the remote in TV/VCR mode.

DVD Puts the remote in DVD mode.

VCR2 Puts the remote in VCR2 mode.

LED (Light Emitting Diode) Indicates programming mode when programming the remote.

AUX Turns on the component you have programmed it to control.

SAT•CABLE Puts the remote in SAT•CABLE mode. The SAT•CABLE button will not function properly without first completing the GUIDE Plus+ system setup procedures.

MUTE Reduces the TV/VCR's volume to its minimum level. When pressed again, restores the volume.

SEARCH Advances the tape approximately 60 seconds. Also displays Index, Zero, and Blank search screens when tape is inserted in the TV/VCR.

CH ^ and v (Channel Up and Down) Scans up or down through the channel list. Press once to change the channel up or down; press and hold to continue changing channels. During tape playback, pressing CH ^ or v adjusts tracking.

VOL < and > (Volume Down and Up) Decreases or increases the TV/VCR's volume.

SPEED (Tape Speed) Selects a recording speed (SP, LP, or SLP). See the section "Recording Features" for more details, including definitions of SP, LP, and SLP.

GO BACK Returns you to the previous channel.

Light Icon Lights some of the remote buttons. The buttons remain lit as long as any button is pressed within approximately four seconds of the last button pressed. The light times out if no buttons are pressed, which conserves the life of your batteries. If the light times out, simply press the button to turn it on again.

GUIDE Brings up and exits the GUIDE Plus+ system. In TV and VCR modes, brings up available on-screen guides (RCA, GE, and PROSCAN products only).

INFO Brings up channel information that display the TV/VCR's current status. Press again to clear the display. Also brings up the time counter when a tape is inserted.

Arrows Used to point to different items in the menu system. Also used to adjust the menu controls.

OK Selects highlighted items or returns you to the previous menu.

MENU Displays the TV/VCR Main Menu. Advances to next program during program review. When in VCR mode, it functions as a PROGRAM button.

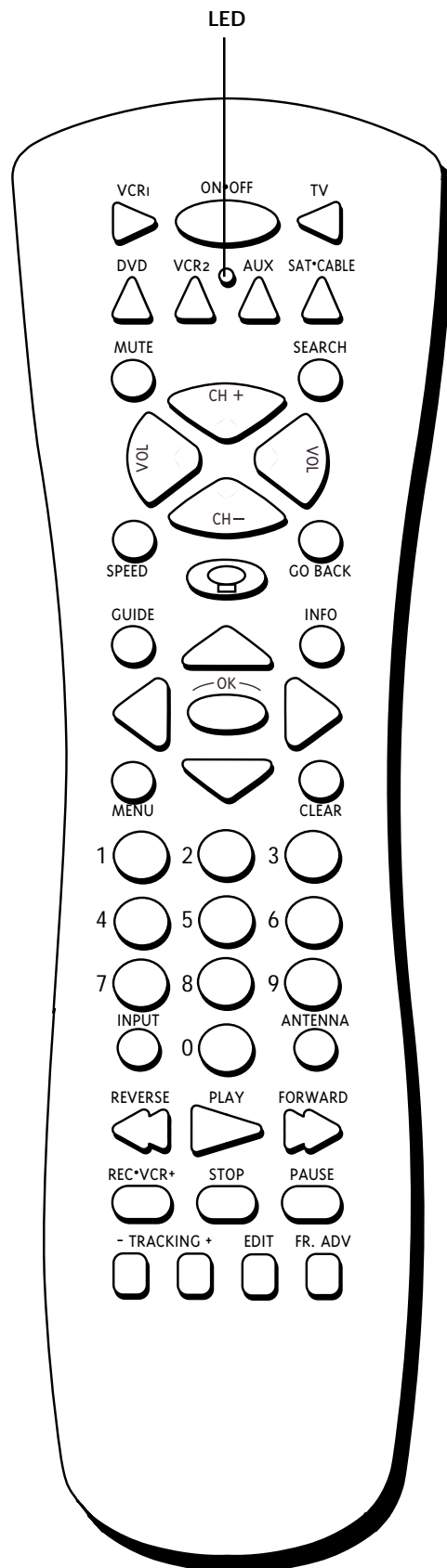

USING THE REMOTE

CLEAR Removes any menu or display from the screen and returns you to TV viewing. Also exits the GUIDE Plus+ menu system. Allows you to change menu entries or clear a timer recording. Resets time counter to 0:00:00 when displayed.

Number Buttons (0-9) Enters channel numbers, digits for programming the remote, and time settings directly through the remote control. To enter a two-digit channel, press the two digits. To enter a three-digit channel, press and hold the first digit, release, then add the second two. For example: to tune to channel 123, press and hold 1, release, press 2, then 3.

INPUT In TV/VCR mode, press to toggle through the available input sources (VIDEO 1, VIDEO 2, current channel).

ANTENNA Functions as TV/VCR button in VCR mode and TV/receiver button in SAT•CABLE mode.

REVERSE Rewinds the tape when the TV/VCR is stopped. Searches the picture in reverse during playback.

PLAY Plays a tape.

FORWARD Fast forwards the tape when the TV/VCR is stopped. Searches the picture in forward motion during playback.

REC•VCR+ Starts TV/VCR recording. Used for express recording. When in the GUIDE Plus+ system, pressing this button brings up the one-button recording screen. When not in the GUIDE Plus+ system, pressing this button will record the program you are currently viewing; however, if you have set a GUIDE Plus+ system-timed recording, that recording will interrupt the TV/VCR recording.

STOP Stops functions such as record, play, rewind, fast forward, and pause.

PAUSE Pauses the tape during playback. Pauses the tape during recording to prevent recording of unwanted scenes.

TRACKING - and + (Tracking Down and Up) Lets you manually adjust tracking to reduce the streaks that may appear in the picture during playback.

EDIT Pressing EDIT during playback pauses the tape. Press again to resume playback. Also, if FR. ADV is pressed, the tape advances frame-by-frame. One way to resume playback is to press EDIT.

FR. ADV (Frame Advance) Fast forwards the tape through a commercial when a tape is playing. Advances the tape one video frame at a time when the tape is paused.

USING THE INPUT BUTTON

Use the INPUT button to toggle through the available input sources and view the component you have connected to the TV/VCR.

1. Press TV to place the remote in TV mode. Make sure that the component you want to view is turned on.
2. Press INPUT to tune to an available input source.
3. Continue to press INPUT to scroll through the input sources.

Modes of Operation

Because this universal remote can control several different components (cable box, another VCR, etc.), it uses operational modes triggered by the component buttons. For example if you want the remote to control the TV/VCR, you would press the TV button to put the remote into TV mode before you could control the TV/VCR.

USING THE REMOTE

PROGRAMMING THE REMOTE

The universal remote can be programmed to control most brands of remote controllable VCRs, satellite receivers, and cable boxes. The remote is already programmed to control most RCA, GE, and PROSCAN TVs, VCRs, DVD players, laserdisc players, and satellite receivers.

TESTING THE REMOTE

To determine whether the universal remote needs to be programmed, turn a device ON, such as a DVD player, point the remote at the DVD player, and press the DVD button. Then press ON•OFF or CH ^ or v to see if the DVD player responds to the remote commands. If not, the remote needs to be programmed.

Using Automatic Code Search

The following instructions can be used to program the remote to control each of the devices connected to your TV. If you want to exit the automatic code search without programming any of your devices, press and hold CLEAR until the LED turns off.

Note that the automatic code search will not work with the AUX button.

To program the remote using automatic code search:

1. Turn on the device you want to control (VCR, SAT, etc.).
2. Press and hold the button you want to program (VCR1, VCR2, etc.). While holding the device button, press and hold ON•OFF until the red light on the remote turns on, then release both buttons.
3. Press and release PLAY, then wait 5 seconds or until the LED stops flashing.

At this point the remote is searching for the correct code to program. If, after 5 seconds, the device you want to control does not turn off, press PLAY again to tell the remote to search the next set of codes.

Continue pressing PLAY until the device turns off or you have searched through all of the codes. There are 20 total sets of codes. If the device does not turn off after pressing PLAY 20 times, then the remote cannot control that particular device.

If the device you want to control *does* turn off:

1. Press and release REVERSE, then wait 2 seconds. Repeat this step until the device turns back on.
2. To finish, press and hold STOP until the red light on the remote turns off.

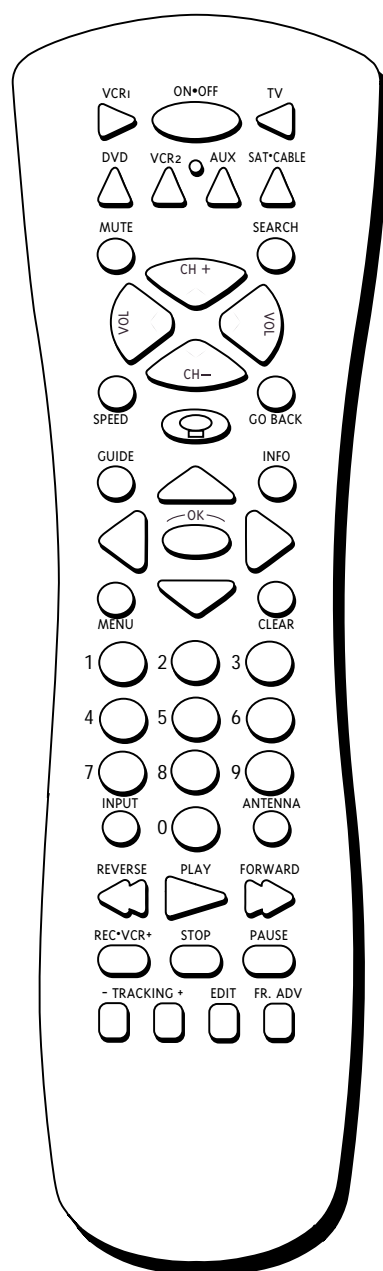

USING THE REMOTE

Using Direct Entry

1. Turn on the component to be programmed.
2. Look up the brand and code number(s) for the component on the code list on the last page of this section, "Using the Remote."
3. Press and hold the appropriate component button (VCR1, DVD, VCR2, AUX, SAT•CABLE).
4. While holding the component button, enter the code from the code list.
5. Release the component button, and then press ON•OFF to see if the component responds to the remote commands. If it doesn't, try pressing the component button and then ON•OFF again.
6. If you get no response, repeat these steps using the next code listed for your brand, until the component responds to the remote commands.

USING THE REMOTE TO CONTROL A DEVICE

Once the remote has been programmed successfully, you are ready to use it to control your devices.

To operate the device:

1. Press the device button (TV, VCR1, VCR2, DVD, AUX, or SAT•CABLE) to set the remote to control the device. Note that the SAT•CABLE button will only work if you have set up the GUIDE Plus+ system and are using a cable box.
2. Press ON•OFF to turn the device ON or OFF.
3. Use the remote buttons that apply to that device.

MODES OF OPERATION

Because this universal remote can control several different components (DVD player, VCR, cable box, etc.) it uses operational modes triggered by the component buttons. For example, if you want the remote to control the TV, you would press the TV button to put the remote into TV mode before you could control the TV.

USING THE REMOTE

VCRs

Admiral	2131
Adventura	2026
Aiko	2027
Aiwa	2002, 2026
Akai	2003, 2004, 2005, 2007, 2008, 2111, 2112, 2113
American High	2021
Asha	2013
Audio Dynamics	2009, 2010
Audiovox	2014
Bell & Howell	2011
Beaumont	2013
Broksonic	2012, 2025
Calix	2014
Candle	2013, 2014, 2015, 2016, 2017, 2018, 2019
Canon	2021, 2022, 2114
Capehart	2020, 2110
Carver	2062
CCE	2027, 2061
Citizen	2013, 2014, 2015, 2016, 2017, 2018, 2019, 2027
Colortyme	2009
Colt	2061
Craig	2013, 2014, 2023, 2061
Curtis-Mathes	2000, 2002, 2009, 2013, 2016, 2018, 2021, 2022, 2024, 2115
Cybernex	2013
Daewoo	2015, 2017, 2019, 2025, 2026, 2027, 2028, 2110
Daytron	2110
Dbx	2009, 2010
Dimensia	2000
Dynatech	2002, 2026
Electrohome	2014, 2029
Electroponic	2014
Emerson	2002, 2012, 2014, 2015, 2021, 2024, 2025, 2026, 2029, 2030, 2032, 2033, 2034, 2035, 2036, 2037, 2038, 2039, 2040, 2041, 2042, 2044, 2045, 2047, 2065, 2105, 2113, 2116, 2117, 2130
Fisher	2011, 2023, 2048, 2049, 2050, 2051, 2052, 2118
Fuji	2021, 2119
Funai	2002, 2026
Garrard	2026
GE	2000, 2001, 2013, 2021, 2022, 2053, 2115, 2120
Goldstar	2009, 2014, 2018, 2054, 2121
Gradiente	2026
Harley Davidson	2026
Harman Kardon	2009
Harwood	2061
Headquarter	2011
Hitachi	2002, 2055, 2056, 2057, 2107, 2111, 2120, 2122
HI-Q	2023
Instant Replay	2021
JCL	2021
JC Penney	2009, 2010, 2011, 2013, 2014, 2021, 2022, 2055, 2056, 2058, 2059, 2060, 2107, 2118
Jensen	2055, 2056, 2111
JVC	2009, 2010, 2011, 2018, 2058, 2111, 2123
Kenwood	2009, 2010, 2011, 2016, 2018, 2058, 2111, 2123
KLH	2061
Kodak	2014, 2021
Lloyd	2002, 2026
Logik	2061
LXI	2014
Magnavox	2021, 2022, 2062, 2063, 2104, 2108, 2124
Magnin	2013
Marantz	2009, 2010, 2011, 2016, 2018, 2021, 2058, 2062, 2064
Marta	2014
Masushita	2021
MEI	2021
Memorex	2002, 2011, 2013, 2014, 2021, 2023, 2026, 2104, 2131
MGA	2029, 2065, 2113
MGN Technology	2013
Midland	2053
Minolta	2055, 2056, 2107
Mitsubishi	2029, 2055, 2056, 2065, 2066, 2067, 2069, 2070, 2071, 2072, 2073, 2074, 2106, 2113, 2123
Montgomery Ward	2075, 2131

Motorola	2021, 2131
MTC	2002, 2013, 2026
Multitech	2002, 2013, 2016, 2026, 2053, 2061
NEC	2009, 2010, 2011, 2016, 2018, 2058, 2064, 2076, 2078, 2079, 2111, 2123
Nikko	2014
Noblex	2013
Olympus	2021
Optimus	2014, 2131
Optonica	2096
Orion	2035
Panasonic	2021, 2022, 2109, 2125, 2126, 2127
Pentax	2016, 2055, 2056, 2107, 2120
Pentec Research	2018
Philco	2021, 2022, 2062, 2063
Philips	2021, 2062, 2096, 2124
Pilot	2014
Pioneer	2010, 2055, 2080, 2081, 2123
Portland	2016, 2017, 2019, 2110
PROSCAN	2000, 2001
Protec	2061
Pulsar	2104
Quarter	2011
Quartz	2011
Quasar	2021, 2022, 2125
RCA	2000, 2001, 2003, 2013, 2021, 2055, 2056, 2082, 2083, 2084, 2085, 2086, 2087, 2088, 2089, 2090, 2091, 2107, 2115, 2120, 2125
Radioshack/Realistic	2002, 2011, 2013, 2014, 2021, 2022, 2023, 2026, 2029, 2049, 2050, 2096, 2131
Radix	2014
Randex	2014
Ricoh	2128
Runco	2104
Samsung	2005, 2013, 2015, 2033, 2053, 2112
Sanky	2131, 2104
Sansui	2010, 2092, 2111, 2123
Sanyo	2011, 2013, 2023
Scott	2012, 2015, 2025, 2032, 2035, 2038, 2065, 2093, 2116
Sears	2011, 2014, 2021, 2023, 2048, 2049, 2050, 2051, 2055, 2056, 2107, 2118
Sharp	2002, 2017, 2029, 2094, 2095, 2096, 2131
Shintom	2004, 2056, 2061, 2098
Shogun	2013
Signature	2002, 2131
Singer	2021, 2061, 2128
Sony	2002, 2004, 2098, 2099, 2119, 2128
STS	2021, 2107
Sylvania	2002, 2021, 2022, 2026, 2062, 2063, 2065, 2124
Symphonic	2002, 2026
Tandy	2002, 2011
Tashiko	2014
Tatung	2058, 2111
TEAC	2002, 2026, 2058, 2085, 2111
Technics	2021, 2109
Teknika	2002, 2014, 2021, 2026, 2100, 2129
TMK	2013, 2024, 2047
Toshiba	2015, 2049, 2051, 2055, 2065, 2093, 2116
ToteVision	2013, 2014
Unitech	2013
Vector Research	2009, 2010, 2015, 2016
Victor	2010
Video Concepts	2009, 2010, 2015, 2016, 2113
Videosonic	2013
Wards	2002, 2013, 2014, 2015, 2021, 2023, 2026, 2029, 2055, 2056, 2061, 2096, 2101, 2102, 2103, 2107, 2116, 2131
XR-1000	2021, 2026, 2061
Yamaha	2009, 2010, 2011, 2018, 2058, 2111
Zenith	2004, 2098, 2104, 2119, 2128

Cable Boxes

ABC	5002, 5003, 5004, 5005, 5006, 5007, 5053
Antronix	5008, 5009
Archer	5008, 5009, 5010, 5011
Cabletenna	5008
Cableview	5008
Century	5011
Citizen	5011

Colour Voice	5012, 5013
Comtronics	5014, 5015
Contec	5016
Eastern	5017
Garrard	5011
GC Electronics	5009
Gemini	5018, 5019, 5049
General Instrument	5003
Hamlin	5020, 5021, 5022, 5035, 5045
Hitachi	5003
Hytex	5002
Jasco	5011
Jerrold	5003, 5005, 5007, 5018, 5023, 5024, 5046, 5053
Magnavox	5025
Memorex	5026
Movie Time	5002, 5027, 5028
NSC	5002, 5027, 5028
Oak	5002, 5016, 5029
Panasonic	5048, 5052
Paragon	5026
Philips	5011, 5012, 5013, 5019, 5025, 5030, 5031, 5032
Pioneer	5033, 5034
Pulsar	5026
RCA	5047, 5049, 5052
Realistic	5009, 5049
Regal	5022, 5035
Regency	5017
Rembrandt	5003
Runco	5026
Samsung	5014, 5034
Scientific Atlanta	5006, 5036, 5037, 5038
Signal	5014, 5018
Signature	5003
SL Marx	5014
Sprucer	5052
Starcom	5007, 5018, 5053
Stargate	5014, 5018
Starquest	5018
Tandy	5040
Televue	5014
Tocom	5004, 5023, 5041
Toshiba	5026
Tusa	5018
TV86	5027
Unika	5008, 5009, 5011
United Artists	5002
United Cable	5053
Universal	5008, 5009, 5010, 5011
Videoway	5044
Viewstar	5015, 5025, 5027, 5040
Zenith	5026, 5050, 5051

Satellite Receivers

Chapparral	5056, 5057
Drake	5058, 5059
GE	5000
General Instruments	5060, 5061, 5062
Panasonic	5075
Primestar	5076
PROSCAN	5000
RCA	5000
Realistic	5063
Sony	5072
STS1	5064
STS2	5065
STS3	5066
STS4	5067
Toshiba	5068
Toshiba	5073
Uniden	5069

Audio

(For RCA and Dimensia brands only)	
AM/FM	4003
Aux	4004
Phono	4005
CD	4007
Tape	4006

OPERATING INSTRUCTIONS

USING YOUR TV/VCR

This section walks you through all the things your TV/VCR can do. It includes information on:

- Playing a tape.
- Using the playback features.
- Recording.
- Copying and editing tapes.

1 SETUP AND CONNECTIONS



2 USING THE REMOTE



3 OPERATING INSTRUCTIONS



4 FEATURES AND CONTROLS



5 REFERENCE

OPERATING INSTRUCTIONS

HOW TO PLAY A TAPE

1. Insert a tape in the TV/VCR.

The TV/VCR automatically turns on. The tape automatically begins to play if the safety tab on the cassette has been removed and the Auto Play feature has been turned on.

2. Press PLAY, if necessary. The word Play and the time counter appear on the screen.
3. If necessary, while the tape is playing, press TRACKING + or - on the remote or CH ^ or v on the TV/VCR to remove any streaks from the picture.
4. Press STOP on the remote or STOP/EJECT on the TV/VCR to stop playback.
5. Press REW on the TV/VCR or REVERSE on the remote to rewind the tape. If the VCR is playing a tape, the TV/VCR will search backwards through the tape. If the TV/VCR is not playing a tape, the tape will rewind back to its start.
 - After the tape reaches its end during playback, it will automatically rewind back to the beginning of the tape and eject the tape.
 - Pressing the remote's ON•OFF button while the tape is rewinding will not stop the tape. The tape will continue to rewind until it reaches its beginning, and then the TV/VCR will turn off.
6. Press FORWARD on the remote to advance the tape. If the VCR is playing a tape when the FORWARD button is pressed, the TV/VCR will search forward through the tape.
7. Press STOP/EJECT on the TV/VCR or STOP on the remote to eject the tape once it is completely rewound.

Note that a cassette may be ejected even if the power is turned off.

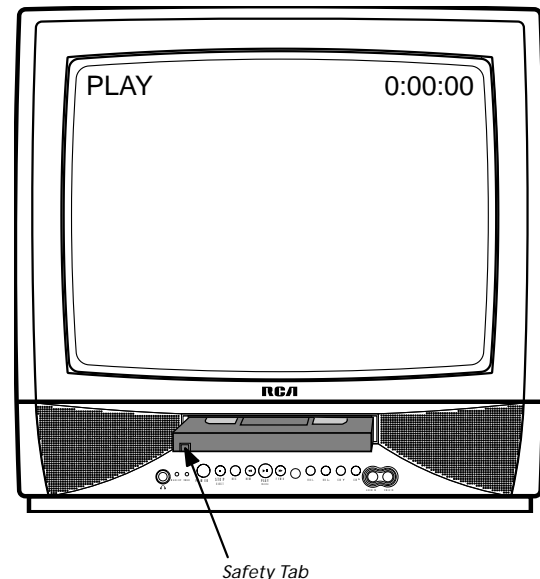

If the GUIDE Plus+ system appears when a tape is inserted, press the GUIDE or CLEAR button on the remote. The GUIDE Plus+ system will disappear in approximately one minute if you do not press any button.

OPERATING INSTRUCTIONS

USING THE PLAYBACK FEATURES

Pause

This feature pauses the tape during playback and allows you to examine the details of the scene. Pause works best with tapes recorded in SLP speed.

1. Press PAUSE during playback to pause the action. The TV/VCR will automatically switch from pause to stop after a few minutes to prevent tape wear.
2. Press PAUSE or PLAY to return to normal playback.

Frame Advance

Frame advance lets you view one frame at a time while in the PAUSE mode. Frame advance works best with tapes recorded in SLP speed.

1. Press PAUSE during playback to pause the action.
2. Press FR. ADV on the remote each time you want to view the next frame of the scene.

Press and hold FR. ADV on the remote to view the tape frame-by-frame.
3. Press PAUSE or PLAY to return to normal playback.

Picture Search

You can visually search a picture during pause mode. Sound is turned off during picture search. Picture search works best for tapes recorded in SLP speed.

1. During playback, press FORWARD on the remote to search forward or REVERSE to search in reverse.
2. Press PLAY to return to normal playback.

Slow Motion (only available on model T19067)

You can view the picture in slow motion during PAUSE mode. There are three slow-motion speeds. Sound is turned off during slow-motion playback.

1. Press PAUSE.
2. Press and hold FR. ADV to begin slow motion.

Press FR. ADV again for the faster slow-motion speed.

Press FR. ADV a third time for the fastest slow-motion speed.
3. Press PLAY to return to normal playback or press PAUSE to return to pause mode.

The TV/VCR will automatically switch from slow-motion playback to stop after a few minutes to prevent tape wear.

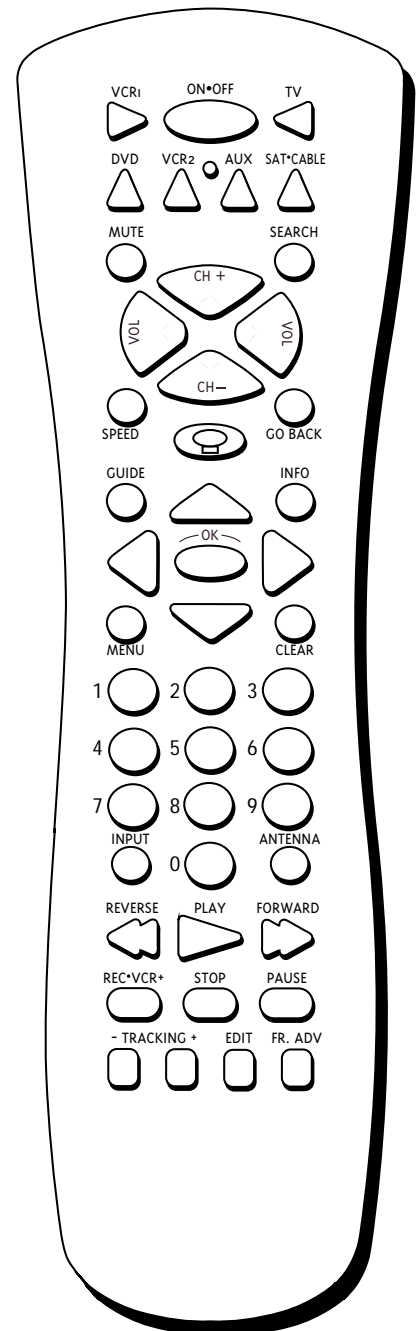

OPERATING INSTRUCTIONS

Automatic Tracking

The TV/VCR has automatic tracking which adjusts the picture when playing a tape that was recorded on another VCR. Automatic tracking is turned on whenever a tape is inserted or the TV/VCR's power is turned on.

Manual Tracking

Occasionally, you may need to manually adjust tracking on a tape recorded on a different VCR or camcorder. Tracking is used when playing a tape. It has no effect during recording.

- When streaks or snow appear in the picture during normal playback or slow motion, press TRACKING + or - on the remote or CH ^ or v on the TV/VCR for the best possible picture.
- To return to automatic tracking the tape must be removed from the VCR and re-inserted.

Time Counter

The time counter helps locate the beginning or end of programs you taped. The time counter automatically resets to 0:00:00 whenever a tape is inserted, or when CLEAR is pressed while the time counter is displayed.

For example, if a 30-minute program was recorded at the beginning of the tape and you wanted to record another program after it, you should:

1. Insert the pre-recorded tape.
2. Press INFO twice to display the time counter and fast forward the tape until 30 minutes appears on the screen. Then you can begin recording a second program.

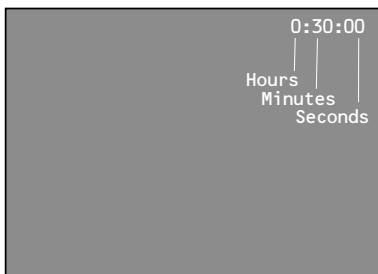

This is the approximate end of the program and you can begin recording at this spot.

3. Press INFO again or eject the tape to remove the time counter from the screen.

Commercial Scan

This is useful for skipping commercials or short program segments. Press SEARCH during playback to advance the tape approximately 60 seconds.

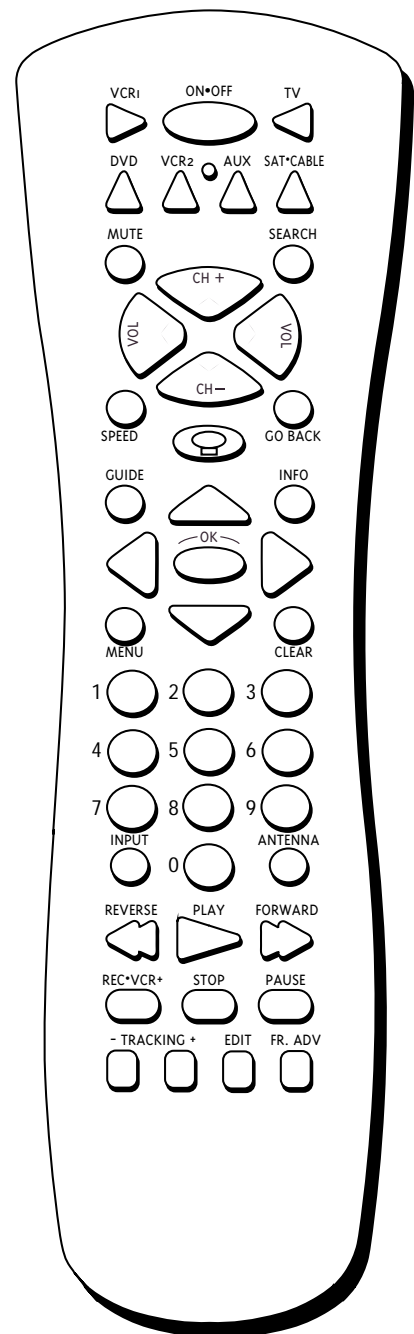

OPERATING INSTRUCTIONS

Auto Play Feature

This feature enables the TV/VCR to automatically start playing a tape when it is inserted. (The safety tab on the tape must be removed.)

1. Press MENU to display the TV/VCR Main Menu.
2. Press 5 to display the Setup menu.
3. Press 4 to change the Auto Play setting.

The Auto Play feature is set to On at the factory.

- Select *On* if you want a tape with its safety tab removed to start playing automatically.
- Select *Off* if you do not want a tape with its safety tab removed to start playing automatically.

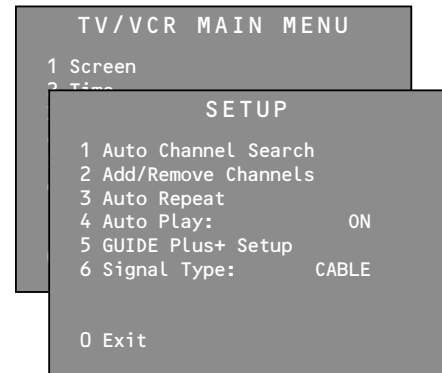

Auto Repeat Feature

This feature tells the TV/VCR to play a tape (or part of a tape) continuously. The TV/VCR will automatically rewind the tape, or a selected portion of the tape, and play it repeatedly.

1. Using REVERSE, FORWARD, or PLAY on the remote, go to the place on the tape that you want to be the **beginning** of the section that automatically repeats. Reset the time counter to 0:00:00 by pressing INFO, then CLEAR.
2. Using FORWARD or PLAY on the remote, go to the place on the tape that you want to be the **end** of the section that plays continuously. Remember the numbers on the time counter. (2:55 is the end time for Auto Repeat in the example to the right.)
3. Press MENU to display the TV/VCR Main Menu.
4. Press 5 to display the Setup menu.
5. Press 3 to display the Auto Repeat menu.
6. Using the number buttons, enter the amount of time you want the tape to repeat (the number from Step 2). In the example at right, the section that the TV/VCR will automatically repeat is 2:55—two hours, 55 minutes long.

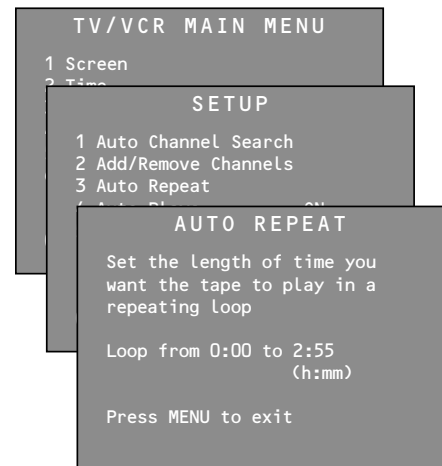

To Cancel Auto Repeat

Press MENU, then 5, then 3, and then CLEAR.

OPERATING INSTRUCTIONS

Index Search

The TV/VCR automatically records index marks on the tape each time you begin recording. During playback you can locate the program you want to play by the number of index marks. Your TV/VCR has two index playback features. You can select a specific index number or search by scan and play.

To Select Scan and Play Index Playback:

1. Insert the pre-recorded tape and press STOP.
2. Press SEARCH on the remote to display the Index Search screen.
3. Press FORWARD on the remote to scan forward or REW to scan in reverse.

When the TV/VCR locates an index mark, it will stop and play a few seconds of the program following the mark.

4. At any time during the search, press PLAY to stop searching and begin playback, or press STOP to stop the search.

If the beginning or end of the tape is reached during the search, the message "End of tape" appears.

To Select a Specific Index Number for Index Playback:

1. Insert the pre-recorded tape and press STOP.
2. Press SEARCH on the remote to display the Index Search screen.

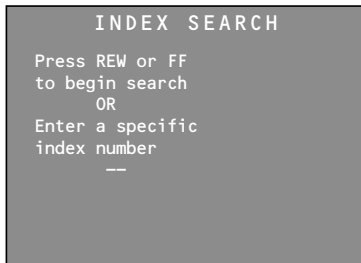

3. Use the number buttons (0-9) on the remote to enter the number of the index mark for which you want the TV/VCR to search.
4. Press FORWARD to search forward or REVERSE to search in reverse.

When the TV/VCR locates the index mark, it will begin playback.

When using index playback, the following index marks may be skipped by the TV/VCR:

- The mark closest to the current location on the tape.
- The mark at the beginning of a recorded segment that is five minutes or less.
- The mark at the beginning of the tape.

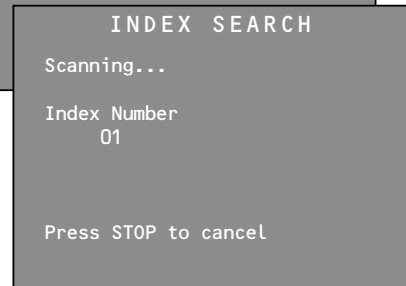
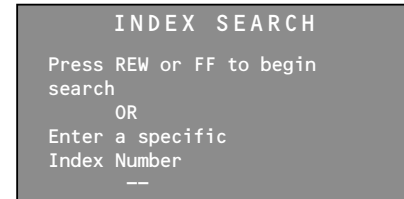

OPERATING INSTRUCTIONS

Zero Search

This feature allows you to quickly return to a time counter reading of 0:00:00. This is especially convenient when you want to watch a segment of the tape several times.

1. Insert the pre-recorded tape and press STOP.
2. Press INFO on the remote twice to display only the time counter.
3. Use PLAY, FORWARD, or REVERSE on the remote to locate the start of the segment you want to repeat.
4. Press CLEAR to reset the time counter to 0:00:00.
5. Continue playing the tape and press STOP when you reach the end of the segment you want to repeat.
6. Press SEARCH twice to display the Zero Search screen. The current time counter is displayed.
7. Press REVERSE or FORWARD on the remote to return to 0:00:00. The tape rewinds or fast forwards to the 0:00:00 and begins playing.

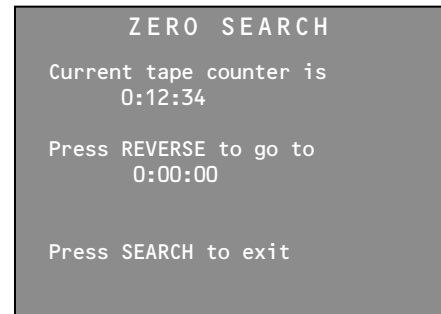

OR

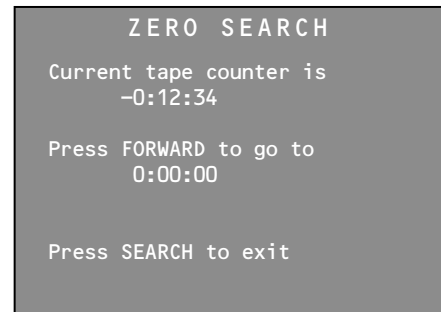

Blank Search

The TV/VCR will search for blank portions of the tape that are more than six seconds in length.

1. Insert the pre-recorded tape and press STOP.
2. Press SEARCH on the remote three times to display the Blank Search screen.



3. Press FORWARD to begin searching for a segment that is at least six seconds of blank tape.
4. Press STOP to stop Blank Search.

OPERATING INSTRUCTIONS

RECORDING FEATURES

Recording Speeds

Press **SPEED** to select a recording speed.

- **SP** (Standard Play) gives the best quality recording; consequently, fewer programs can be recorded on the tape. Most pre-recorded, rental tapes are recorded in SP.
- **LP** (Long Play) gives twice the recording time of tapes recorded in SP. Special effects such as pause, slow motion, picture search, and frame advance are not recommended in this speed.
- **SLP** (Super Long Play) gives three times the recording time of tapes recorded in SP. Special effects such as pause, slow motion, picture search, and frame advance work in this speed.

Recording Pause

This feature allows you to prevent recording short passages of unwanted material.

- Press **PAUSE** during recording to temporarily stop and start recording. While the tape is paused, the front panel indicator light inside the **REC** button will flash. The TV/VCR will automatically switch from pause to stop after a few minutes to prevent tape wear.

Automatic Head Cleaner

The TV/VCR has an automatic head cleaner system. When a cassette is inserted, the head cleaning system is activated. This system minimizes the need for accessory cleaners or a visit to a service center.

Types of Recordings

Your TV/VCR provides different ways to record which are explained in the following sections:

- Basic Recording
- Express Recording
- Timer Recording
- Copying and Editing Tapes

Cassette	Recording Time		
	SP	SLP	LP
T-120	2 hours	6 hours	4 hours
T-160	2 hrs 40 min	8 hours	5 hrs 20 min

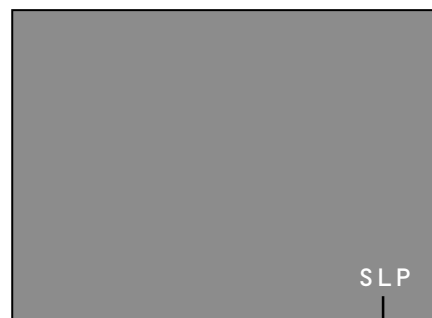

Tape Speed Indicator

OPERATING INSTRUCTIONS

BASIC RECORDING

The GUIDE Plus+ system recording timer will override the VCR eight-event timer, and Sleep or Wake-up timers if you have set conflicting timed events in the GUIDE Plus+ system. If the VCR-timed recordings are already in progress, they will be interrupted and the GUIDE Plus+ system-timed recording will begin as scheduled.

1. Insert a tape with safety tab in place. The TV/VCR will turn on.
2. Press SPEED to select a recording speed. The tape speed indicator appears.
3. Select the channel to be recorded.
4. Press REC•VCR+ on the remote to begin recording. The indicator light in the REC button on the front of the TV/VCR turns on during recording.
5. Press STOP/EJECT on the TV/VCR or STOP on the remote to stop recording.

EXPRESS RECORDING

The GUIDE Plus+ system recording timer will override the VCR eight-event timer, and Sleep or Wake-up timers if you have set conflicting timed events in the GUIDE Plus+ system. If the VCR-timed recordings are already in progress, they will be interrupted and the GUIDE Plus+ system-timed recording will begin as scheduled.

Express recording lets you record up to four hours or to the end of the tape without programming the timer. You can begin recording immediately. The TV/VCR will stop automatically at the end of the recording.

To use express recording:

1. Insert a tape with safety tab in place. The TV/VCR will turn on.
2. Select the channel to be recorded.
3. Press SPEED to select a recording speed. You can also change the speed of the recording in progress.
4. Press REC•VCR+ twice to activate express recording.
5. Press REC•VCR+ repeatedly until the desired amount of recording time is displayed.
6. During express recording, press REC•VCR+ to display the time remaining on the screen. Press REC•VCR+ again to increase the recording time. The TIMER indicator on the TV/VCR's front panel will light during express recording.

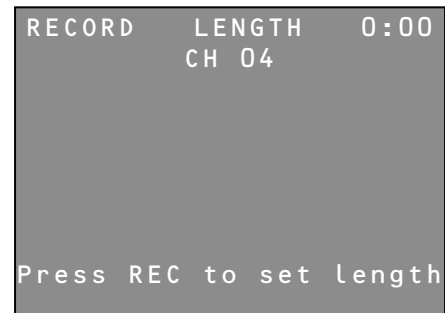

Each time you press RECORD, the recording time increases as shown below:

Press RECORD	Recording Time
0:30	(30 minutes)
1:00	(One hour)
1:30	(One hour 30 min)
2:00	(Two hours)
3:00	(Three hours)
4:00	(Four hours)
0:00:00	(Normal record)
0:00	(Turns off)

OPERATING INSTRUCTIONS

To stop an express recording in progress:

- Press and hold STOP/EJECT on the TV/VCR or STOP on the remote to stop the express recording.
— OR —
- Repeatedly press REC•VCR+ until Record Length: 0:00 appears. The recording stops after a few seconds.

TIMER RECORDING

The GUIDE Plus+ system recording timer will override the VCR eight-event timer, and Sleep or Wake-up timers if you have set conflicting timed events in the GUIDE Plus+ system. If the VCR-timed recordings are already in progress, they will be interrupted and the GUIDE Plus+ system-timed recording will begin as scheduled.

Timer recording lets you program the TV/VCR to record up to eight different programs. This is useful if you plan on being away from home for a long period of time. Before setting the timer, make sure that the clock is set correctly.

To set a timer recording:

1. Press MENU to display the TV/VCR Main Menu.
2. Press 3 to display the Timer Recordings menu.
3. Press 1 to Create a New Program.
4. Press 1, 2, 3, or 4 to select the type of program.
 - 1 One time — single program recorded once.
 - 2 Daily — program recorded at same time every day.
 - 3 Weekdays — program recorded at same time Monday through Friday.
 - 4 Weekly — program recorded at same time once a week.
5. Use the number buttons to enter the channel number, start time, end time, and start date of the recording.
 - After you enter the start time, press 1 for AM or 2 for PM. Example: For a time of 5:07 PM, press 5, then 0, then 7, and then 2. Repeat for end time.
 - Press CLEAR to correct an entry.
6. Press SPEED to select a recording speed.
7. Press MENU to save your program.
8. Repeat steps 3 – 6 for additional programs.
9. Insert a tape with safety tab intact before the recording is to begin.
 - The TIMER indicator lights in the TV/VCR's front panel.

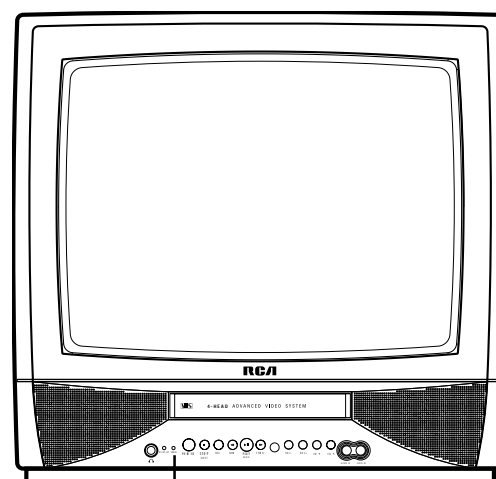

TIMER Indicator

OPERATING INSTRUCTIONS

- If you turn the TV/VCR off, the TIMER indicator will flash if there is no cassette in the TV/VCR or the safety tab is missing from the cassette.

10. If using a cable box, turn it on and tune it to the channel you want to record before time for the recording to begin.

To check or clear a timer recording:

1. Press MENU on the remote to display the TV/VCR Main Menu.
2. Press 3 to display the Timer Recordings menu.
3. Press 2 to Review Existing Programs.
4. Press CLEAR to erase a program.
5. Press MENU to review the next program in sequence.
6. After you have reviewed all of your programs press MENU to exit.

To stop a timer recording:

- If it is a TV/VCR-timed recording, press and hold STOP/EJECT on the TV/VCR or STOP on the remote. A timer program in progress will be stopped. Only today's recording of a Daily, Weekdays, or Weekly program is canceled. The Daily, Weekdays, or Weekly program remains in the timer.
- If it is a GUIDE Plus+ system-timed recording, you cannot stop it using the remote or front panel. You must cancel the timer through the GUIDE Plus+ system.

COPYING AND EDITING TAPES

Use another VCR or camcorder as the playback VCR and the TV/VCR as the recording VCR.

1. Turn on the VCR or camcorder and the TV/VCR.
2. Press 00 on TV/VCR's remote to select the line input (VIDEO 1 or VIDEO 2). Pressing 00 once tunes the TV/VCR to the AUDIO/VIDEO 1 input jacks on the **rear** of the TV/VCR. Pressing 00 twice tunes the TV/VCR to the AUDIO/VIDEO 2 input jacks on the **front** of the TV/VCR.
3. Insert the tape you want to copy into the playback VCR or camcorder. Insert a blank tape with safety tab intact into the TV/VCR.
4. Start the playback VCR or camcorder playing. If the tape was not recorded on the playback VCR, streaks may appear and you may need to adjust the tracking. When you reach the place you want to begin copying, place the playback VCR or camcorder in play pause.
5. Press RECORD, then PAUSE on the TV/VCR's remote.

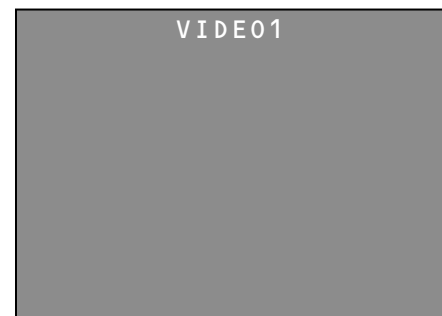
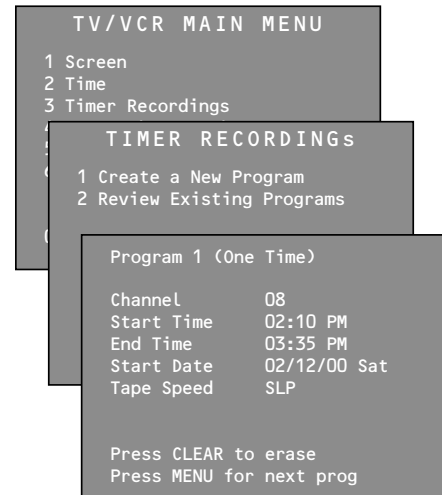

OPERATING INSTRUCTIONS

6. Press PAUSE on **both** the VCR or camcorder and the TV/VCR's remote **at the same time** to begin copying the tape.
7. Edit out segments that you do not want to copy by pressing PAUSE on the TV/VCR's remote to pause the tape. Then, locate the next segment you want to copy on the playback VCR or camcorder by using FORWARD, REVERSE, or PLAY. Press PAUSE on the playback VCR or camcorder. Press PAUSE **at the same time on both** the VCR or camcorder and the TV/VCR's remote to resume copying.
8. Press STOP on **both** the VCR or camcorder and the TV/VCR's remote when you are finished.

The unauthorized recording of television programs and other materials may infringe upon the rights of others.

FEATURES AND CONTROLS

USING THE FEATURES AND CONTROLS

This section introduces you to the features and controls with which your TV/VCR is equipped. In this section, you will learn how to use:

- On-screen displays.
- The GUIDE Plus+ Menu system.
- Parental controls, including V-Chip rating limits.

1 SETUP AND CONNECTIONS



2 USING THE REMOTE



3 OPERATING INSTRUCTIONS



4 FEATURES AND CONTROLS



5 REFERENCE

FEATURES AND CONTROLS

USING ON-SCREEN DISPLAYS

When you change channels, adjust volume, or use a VCR feature, on-screen displays appear to let you know the status of the TV/VCR.

CALLING UP ON-SCREEN DISPLAYS

1. Press INFO to display the function, time counter, date, time, and tape speed. If you do not press INFO again, these displays will time out and disappear.
2. Press INFO again:
 - **No tape in TV/VCR:** Displays are removed.
 - **Tape in TV/VCR:** Time counter remains on screen, and will not time out. Press INFO again to remove the time counter.

ADJUSTING THE VIDEO

Use the SCREEN menu to adjust the picture for your personal preference. The TV/VCR will remember the settings you select.

To Adjust Video:

1. Press MENU on the remote to display the TV/VCR Main Menu.
 2. Press 1 to display the Screen menu.
 3. Press 1 to display the Picture Quality menu.
 4. Press CH ^ or v to select the function you want to adjust.
 - Select *Color* to adjust color intensity.
 - Select *Tint* to adjust for natural flesh tones.
 - Select *Contr* (contrast) to adjust picture contrast.
 - Select *Brite* (brightness) to adjust picture brightness.
 - Select *Sharp* (sharpness) to adjust picture sharpness.
 5. Press VOL < or > to adjust the function selected.
- Press CLEAR to reset the controls to factory defaults.

Pressing INFO
with no tape
inserted:

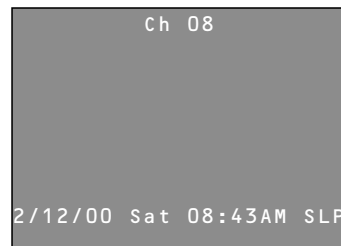

Pressing INFO
once with
tape inserted:

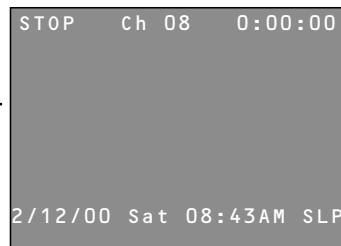

Pressing INFO
twice with
tape inserted:

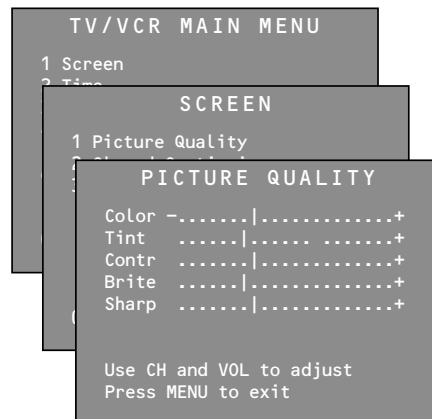
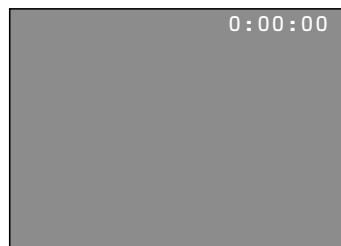

FEATURES AND CONTROLS

ABOUT CLOSED CAPTIONING

The closed captioning feature displays the audio portion of a program as text on the TV screen. This is useful to the hearing impaired or anyone who wants to watch a program without sound.

There are four types of closed captions: Caption 1, Caption 2, Text 1 and Text 2. Caption 1 displays the full translation of the primary language in your area. Caption 2 may be used as a second source for secondary languages. Text 1 and Text 2 display on-screen boxes containing the text of general information not necessarily related to the program being watched.

Closed captioning is not available on all channels. Check your TV program listings for CC (closed caption) broadcasts.

TO VIEW CLOSED CAPTIONING

1. Press MENU on the remote to display TV/VCR Main Menu.
2. Press 1 to display the Screen menu.
3. Press 2 to display the Closed Captioning menu.
4. Press 1 to change the Display.
 - There are three choices: Off, On, and On When Muted.
 - Each time you press 1 the Display will change on the Closed Captioning menu.
5. Press 2 to select the Mode.
 - There are four choices: Caption 1, Caption 2, Text 1, and Text 2.
 - Each time you press 2 the Mode will change on the Closed Captioning menu.

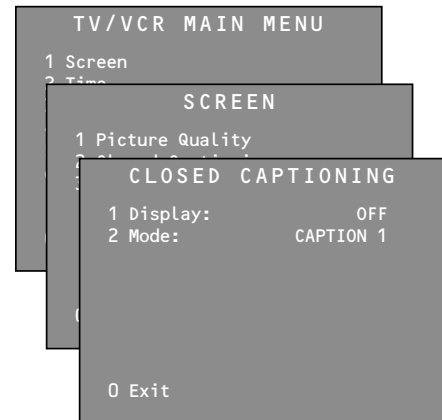

FEATURES AND CONTROLS

USING SLEEP TIMER

The sleep timer automatically turns the TV/VCR off after 30, 60, 90, or 120 minutes.

1. Press MENU on the remote to display the TV/VCR Main Menu.
2. Press 2 to display the Time menu.
3. Press 1 to display the Sleep Timer screen.
4. Press CH ^ or v to select 30, 60, 90, or 120 minutes.

While watching a program, press INFO to check the amount of time remaining before the TV turns off.

5. To cancel the sleep timer, first display the Sleep Timer screen by repeating steps 1-4 above. Then, repeatedly press CH ^ or v until "0:00" is displayed on the screen.

WAKE-UP TIMER

The timer turns the TV/VCR on at a desired time. You can set it to wake you up in the morning or remind you that a favorite program is about to start.

1. Press MENU on the remote to display the TV/VCR Main Menu.
2. Press 2 to display the Time menu.
3. Press 2 to display the Wake-Up Timer menu.
4. Use the number buttons (0-9) to enter the channel number and time.
 - After you enter the time, press 1 for AM or 2 for PM. Example: For a time of 5:07 PM, press 5, then 0, then 7, then 2.
 - Press GO BACK to correct an entry and CLEAR to clear the time.

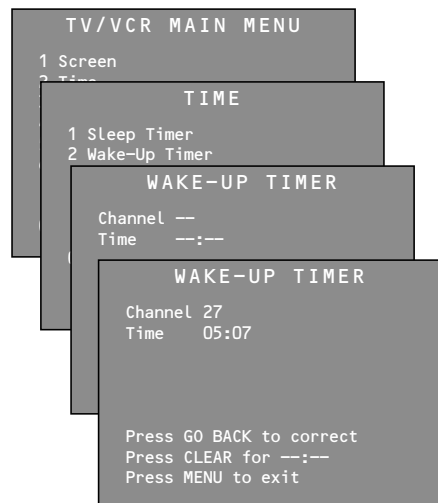
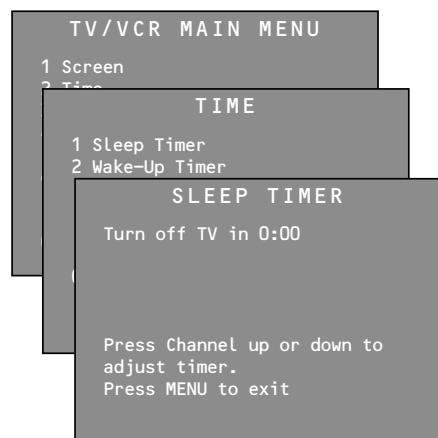
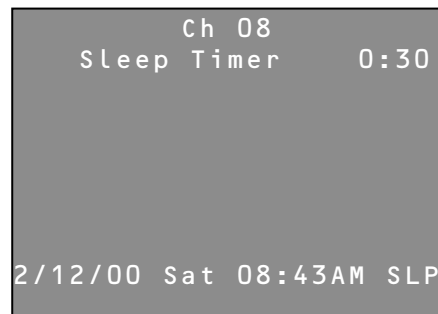

If you have set the sleep timer or wake-up timer to activate anytime during a GUIDE Plus+ system-timed recording, the sleep timer or wake-up timer will not activate.

FEATURES AND CONTROLS

5. Press MENU to set the timer.
 - The wake-up timer will turn on the TV/VCR every day. The WAKE-UP indicator light on the front panel is illuminated when the wake-up timer is set.
 - Once the TV/VCR is turned on by the wake-up timer, the unit automatically turns off after 60 minutes if no buttons are pressed.

Note: When the wake-up timer turns on the TV/VCR, the volume level does not change from when the TV/VCR was last turned off.
6. To cancel the wake-up timer, first display the Wake-Up Timer menu by repeating steps 1-3 above. Then, clear the setting by pressing CLEAR, and press MENU to exit. The timer is also canceled if MENU is pressed before step 4 is completed.

FEATURES AND CONTROLS

PARENTAL CONTROLS AND V-CHIP

The Parental Controls menu allows you to program your TV/VCR so that children cannot see certain programs.

The first three choices in the Parental Controls menu involve a feature inside your TV/VCR called V-Chip which allows you to "block" TV programs and movies based on violence, sex, or other content you may believe children should not view. In other words, it lets you program your TV so it will not display certain programs. Once you block programs, you or other adults are not limited to only parent-approved programs; you can "unblock" programs by entering a password.

The V-Chip inside your TV/VCR comes turned "off," so if you choose not to implement it, you can just ignore it.

When turned "on," the V-Chip reads a code that most broadcasters send with programs. That code tells the V-Chip the program's age-based rating (TV-MA, TV-14, etc.) and content themes (Violence (V), Adult Language (L), etc.). If you have blocked the rating and/or content themes that the program contains, you will receive the message, "This channel is not approved for viewing," when you turn to that particular channel. Broadcasters are not required to provide content themes, so programs received with no content themes will only be blocked if you block their age-based rating. You can also block out programs that have not been given a rating, and programs that are considered "unrated" because no code has been sent by the broadcaster.

The age-based ratings and content themes you can block are listed in the table below.

Age-Based Rating	Description and Content Themes for Age-Based Ratings
TV-MA	Mature Audience Only. This program is specifically designed to be viewed by adults and may be unsuitable for children under 17. It contains one or more of the following content themes: graphic violence (V), explicit sexual activity (S), or crude indecent language (L).
TV-14	Parents Strongly Cautioned. This program contains some material that many parents would find unsuitable for children under 14. Parents are strongly urged to exercise greater care in monitoring this program and are cautioned against letting children under the age of 14 watch unattended. This program contains one or more of the following content themes: intense violence (V), intense sexual situations (S), strong coarse language (L), or intensely suggestive dialogue (D).
TV-PG	Parental Guidance Suggested. This program contains material that parents may find unsuitable for younger children. Many parents may want to watch it with their younger children. The program contains one or more of the following content themes: moderate violence (V), some sexual situations (S), infrequent coarse language (L), or some suggestive dialogue (D).
TV-G	General Audience. Most parents would find this program suitable for all ages. It contains little or no violence (V), no strong language (L) and little or no sexual dialogue (D) or situations (S).
TV-Y7	Directed to Children 7 years and older. This program is designed for children ages 7 and above. It may be more appropriate for children who have acquired the developmental skills needed to distinguish between make-believe and reality. Themes and elements in this program may include mild fantasy violence (FV) or comedic violence, or may frighten children under the age of 7.
TV-Y	All Children. This program is designed to be appropriate for all children. The themes and elements in this program are designed for a young audience, including children from ages 2-6. This program is not expected to frighten younger children.

FEATURES AND CONTROLS

SETTING TV RATING LIMITS

1. Press MENU on the remote to display the TV/VCR Main Menu.
2. Press 4 to display Parental Controls menu.
3. Press 1 to display the V-Chip TV Rating Limit screen.
4. Use the number buttons (1-7) to change the status of a TV program rating.

Remember, once you have set your limits, you must lock your Parental Controls settings for rating limits to take effect. See "Lock/Unlock Parental Controls," later in this section.

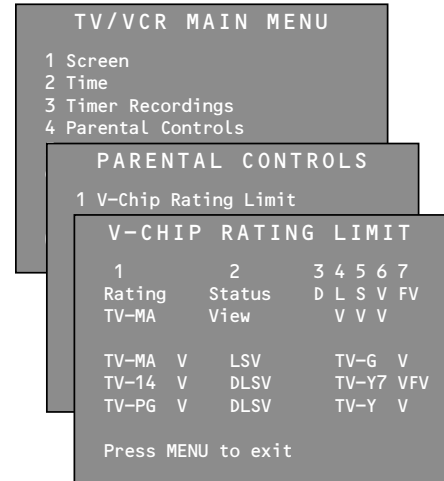

Pressing 0 on the remote will reset all ratings to View and V.

Rating Status Field

Pressing 2 lets you select whether the status of the age-based rating limit to the left is View or Block.

Rating Field

Pressing 1 lets you select from a list of age-based ratings.

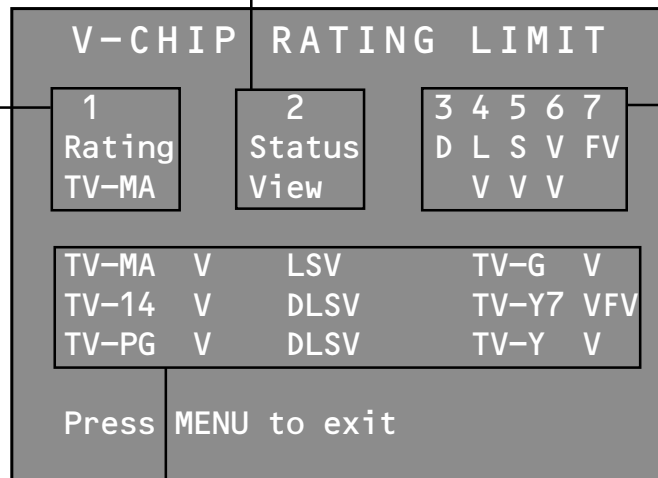

Content Status Fields

Displays which content themes are applicable to the age-based rating selected in the Rating Field. Pressing 3-7 lets you toggle between View (V) and Block (B) for the following fields: Suggestive Dialog (D), Language (L), Sexual Situations (S), Violence (V), and Fantasy Violence (FV).

Rating Settings Area

Lets you see the current block/view state of age-based ratings and associated content. The color of the content theme letter indicates its status: Green = View, Red = Block.

FEATURES AND CONTROLS

BLOCKING AGE-BASED RATINGS

You can automatically block all program ratings above a specified age-based rating level. For example, if you only want your child to watch programs that have a TV-G rating and lower (in other words, you want the child to watch TV-G, TV-Y7, and TV-Y), then you need to block out other programming with higher ratings.

To block programs:

1. Determine the lowest level rating you do not want the child to watch.
2. Continuously press 1 on the remote to scroll through the age-based ratings. Stop pressing 1 when the lowest rating you do not want the child to watch appears. (In the example, you would press 1 until TV-PG appeared on screen, since the highest rating you want the child to watch is TV-G).
3. Press 2 to change the rating status from View (V) to Block (B). The status for this rating and all higher ratings automatically changes to Block (B) (indicated by the rating limits in the rating status area turning red). Note that all associated content is also automatically blocked.

V-CHIP RATING LIMIT									
1	2		3	4	5	6	7		
Rating	Status		D	L	S	V	FV		
TV-PG	Block		B	B	B	B			
TV-MA	B	LSV					TV-G	V	
TV-14	B	DLSV					TV-Y7	VFV	
TV-PG	B	DLSV					TV-Y	V	

Press MENU to exit

Changing the TV-PG rating status from View (V) to Block (B) causes the higher ratings and content to block out as well.

VIEWING AGE-BASED RATINGS

After you block age-based ratings, you have the option of going back and changing some of the content ratings back to View (V).

1. Determine the rating you want to view that is currently blocked.
2. Continually press 1 until the rating status corresponding with the age-based rating you want to change appears on the screen.
3. Press 2 to change the status from Block (B) to View (V). Your child would then be able to watch all programs with a TV-14, TV-G, TV-Y7, and TV-Y rating.

Note that TV-14's content status fields at the bottom of the screen automatically change to a view state, indicated by green letters. These are the only fields that automatically change back to green when you complete this process.

V-CHIP RATING LIMIT									
1	2		3	4	5	6	7		
Rating	Status		D	L	S	V	FV		
TV-14	Block		V	V	V	V			
TV-MA	B	LSV					TV-G	V	
TV-14	V	DLSV					TV-Y7	VFV	
TV-PG	B	DLSV					TV-Y	V	

Press MENU to exit

Viewing Age-Based Ratings: Press 2 to change the status back to View.

FEATURES AND CONTROLS

BLOCKING SPECIFIC CONTENT THEMES

You can block programs based on their content. (Content is represented by the D, L, S, V, and FV on your screen.) When you block a content theme for a particular rating, you automatically block that content theme for higher-rated programs as well.

For example, if you do not want your child to watch programs that have adult language (L) rated TV-PG or higher, then you would also block out all programming TV-PG and above containing adult language.

To block program content:

1. Determine the lowest level age-based content you do not want the child to watch.
2. Press 1 until the lowest age-based rating whose content theme you do not want the child to watch appears on screen.
3. To change the content theme to Block (B), press the number on the remote that corresponds with the content theme you want to block:
 - Sexually suggestive dialogue (D) = 3
 - Adult language (L) = 4
 - Sexual situations (S) = 5
 - Violence (V) = 6
 - Fantasy violence (FV) = 7
4. After you press the number, the V for the content theme should change to a B in the content status field. In the ratings settings area, all higher ratings' content theme status will automatically change to Block (letters will turn red).

Remember: You must lock your Parental Controls settings for rating limits to take effect.

VIEWING SPECIFIC CONTENT THEMES

After you block specific content themes, you have the option of going back and changing some of the content themes back to View (V).

1. Determine the rating you want to change to View (V).
2. Continuously press 1 until the rating status corresponding with the content theme(s) you want to change appears on screen.
3. To change the content theme from Block (B) to View (V), press the number on the remote that corresponds with the content theme you want to view.
4. After you press the number, the B should change to V in the content status field.

V-CHIP RATING LIMIT									
1	2		3		4	5	6	7	
Rating	Status		D	L	S	V	FV		
TV-PG	View		V	B	V	V			
TV-MA	V	LSV	TV-G	V					
TV-14	V	DLSV	TV-Y7	VFV					
TV-PG	V	DLSV	TV-Y	V					

Press MENU to exit

Selecting TV-PG and the content theme Adult language (L) blocks all programs with Adult language (L) rated TV-PG and higher.

Pressing CLEAR exits Parental Controls without saving your changes.

V-CHIP RATING LIMIT									
1	2		3		4	5	6	7	
Rating	Status		D	L	S	V	FV		
TV-PG	View		B	V	B	B			
TV-MA	B	LSV	TV-G	V					
TV-14	B	DLSV	TV-Y7	VFV					
TV-PG	V	DLSV	TV-Y	V					

Press MENU to exit

Note that only the content theme status corresponding to the rating you selected changes to View (V). Higher-rated content themes, such as that for TV-MA language, do not change to View (V).

FEATURES AND CONTROLS

SETTING MOVIE RATING LIMITS

You set movie rating limits by blocking movies rated above a specified level.

To access the V-Chip Movie Rating Limit menu:

1. Press MENU to access the TV/VCR Main Menu.
2. Press 4 to display the Parental Controls menu.
3. Press 2 for the V-Chip Movie Rating Limit screen.
4. Use the number buttons (1-2) to change the status of a movie rating.

Remember: You must lock your Parental Controls settings for rating limits to take effect.

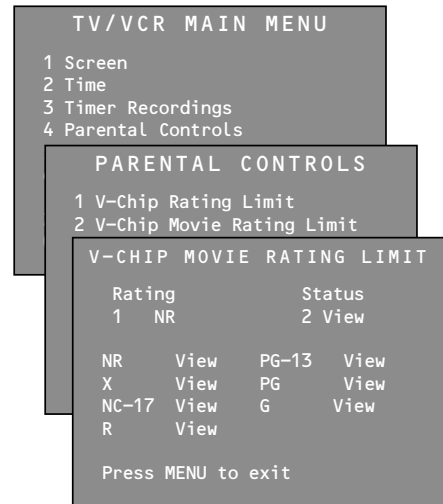

BLOCKING MOVIE RATINGS

If you only want your child to watch movies that have a PG rating and lower (in other words, movies rated PG and G), then you could automatically block out all other movies with higher ratings.

To block movies:

1. Determine the lowest level rating you do not want the child to watch.
2. Continuously press 1 until the lowest rating you do not want the child to watch appears as the rating. (In the example above, you would keep pressing 1 until the rating status scrolled to PG-13, since the highest rating you want the child to watch is PG.)
3. Press 2 to change the status from View to Block. All higher ratings' status will automatically change to Block.

Remember: You must lock your Parental Controls settings for rating limits to take effect.

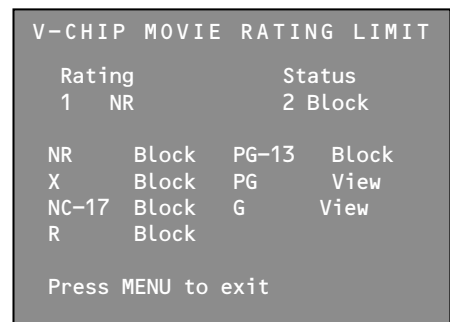

Change the status from View to Block and all higher-rated movies will also be blocked.

VIEWING MOVIE RATINGS

After you block movie ratings, you have the option of going back and changing some of the rating statuses back to View.

1. Determine the movie ratings you want to change to View.
2. Continuously press 1 until the rating you want to change appears on the screen.
3. Press 2 to change the status from View to Block.

For example, if movies with a rating of PG-13 and higher are blocked, you can change the rating status button corresponding with NC-17. Your child would then be able to watch all movies with a G, PG, and NC-17 rating.

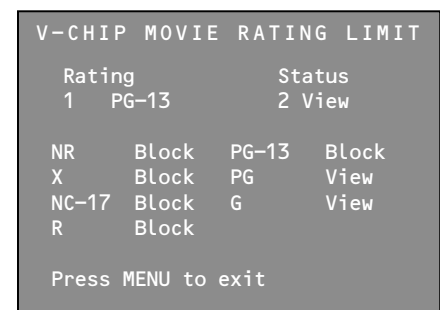

Viewing Movie Ratings: Pressing 2 on the remote changes the status back to View.

Pressing 0 on the remote will reset all ratings to View and V.

FEATURES AND CONTROLS

BLOCKING UNRATED TV PROGRAMS

Some TV programs are not rated but may contain material you do not want your children to see. These programs must be blocked separately.

1. Press MENU to display the TV/VCR Main Menu.
2. Press 4 to display the Parental Controls menu.
3. Press 3 to select Unrated Programs from the menu and to toggle between View and Block.

Note that unrated programs may include news, sports, political, religious, local and weather programs, emergency bulletins, public announcements and programs without a rating.

LOCK/UNLOCK PARENTAL CONTROLS

Selecting this option lets you lock and unlock Parental Controls settings using a password.

If you do not lock Parental Controls, none of the settings for V-Chip Rating Limit or Unrated Programs will take effect.

1. Press MENU to display the TV/VCR Main Menu.
2. Press 4 to display the Parental Controls menu.
3. Press 4 to display the Lock Parental Controls screen.
4. Using the number buttons (0-9) enter a four-digit password. Press CLEAR to make any corrections and MENU to exit.

Once you have set your password, the V-Chip Rating Limit and Unrated Programs settings become active. If you try to access a program that is blocked, the screen displays the message "This channel has not been approved for viewing." Follow the instructions on the screen to enter your password and temporarily override the rating limits.

To unlock the Parental Controls settings, you must use your password to access the Parental Controls menu.

1. Press MENU to display the TV/VCR Main Menu.
2. Press 4 to display the Parental Controls menu.
3. Follow the instructions on the screen and enter your password.
4. Press 4 to unlock Parental Controls.

If you forget your password, press STOP/EJECT on the TV/VCR front panel and MENU on the remote simultaneously. This resets the password, but not the limits you've set.

Remember: You must lock your Parental Controls settings for rating limits to take effect.

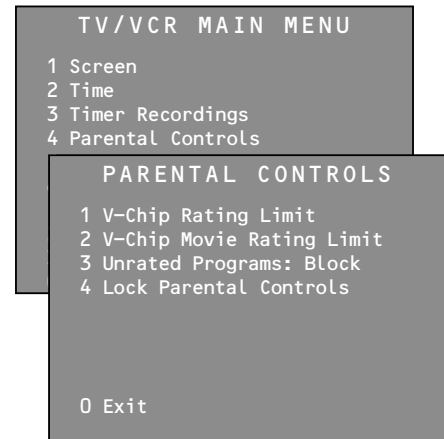

Press 3 to toggle between View and Block for Unrated Programs.

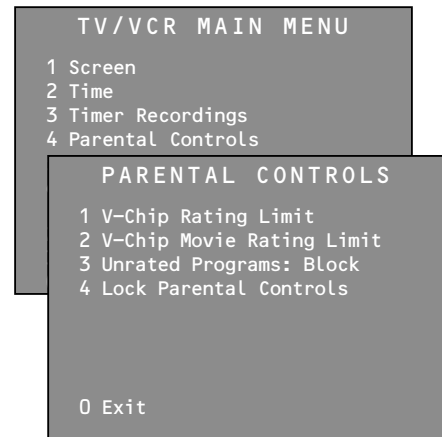

FEATURES AND CONTROLS

USING THE GUIDE Plus+ SYSTEM

The GUIDE Plus+ system is an interactive on-screen program guide that lists TV schedules for your area and allows your TV direct control of a cable box and VCR. You must first set up the GUIDE Plus+ menu in order to view it.

To bring up the GUIDE Plus+ screen, press GUIDE. There are five sections to a GUIDE Plus+ screen:

- A row of Action buttons at the top of the screen (1, 2 and 3)
- Program information
- A row of Menu options
- Channel listings
- Advertising and special show information

You can also access the GUIDE Plus+ menu by pressing MENU on the remote and then selecting *GUIDE Plus+ Menu*. If you press MENU on the remote, you can access several other features:

GUIDE Plus+ Setup Displays the GUIDE Plus+ Setup screen.

Setup Setting up the GUIDE Plus+ system is detailed in "Setup," later in this section.

View Demo Runs the GUIDE Plus+ system demonstration.

Options Displays the GUIDE Plus+ autodisplay options.

On Automatically displays the GUIDE Plus+ system when you use the TV button or the ON•OFF button on the remote to turn on the TV.

Off Disables the GUIDE Plus+ system from being displayed when you use the TV button or the ON•OFF button on the remote to turn on the TV.

Continuous Demo Runs the GUIDE Plus+ demonstration until it is turned off. To end the Continuous Demo, press MENU.

GUIDE Plus+ Label Displays the GUIDE Plus+ label menu.

On Displays the station name when you change channels.

Off Disables the Label feature.

The following sections tell you more about the GUIDE Plus+ system, how to use it, and how it works.

Note: GUIDE Plus+ screens illustrated in this book are representations of what you are likely to see. Not all channels, programs, and GUIDE Plus+ information depicted will be available in your area. New features and options can be downloaded to the GUIDE Plus+ system, so these too are subject to change.

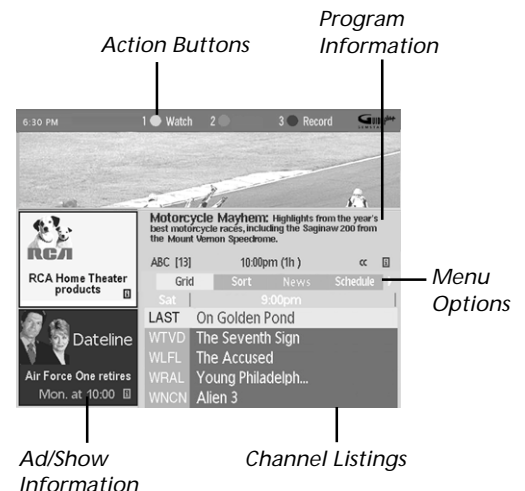
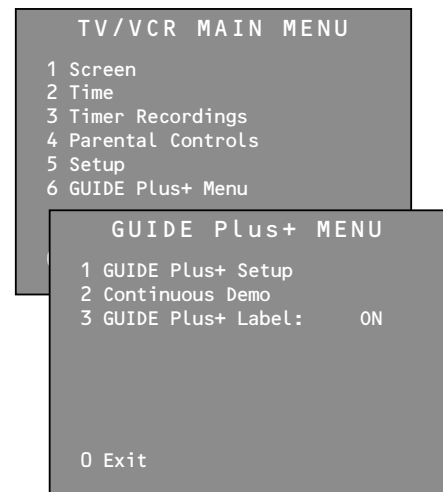

FEATURES AND CONTROLS

GETTING IN & OUT OF THE GUIDE Plus+ SYSTEM

To enter the GUIDE Plus+ system, press GUIDE on the remote.

There are three ways to exit the GUIDE Plus+ system:

- Press OK to exit the GUIDE Plus+ system and tune to the channel highlighted in the Channel listing.
- Press GUIDE to exit the GUIDE Plus+ system and tune to the channel displayed in the background.
- Press CLEAR to exit the GUIDE Plus+ system and return to the last channel you were watching.

DOWNLOADING DATA

The GUIDE Plus+ system is not available until it completes its first download of Program information. When the power is turned off, the TV locates a "host channel" that carries GUIDE Plus+ data containing Program schedule and Channel Mapping information. (A channel map is the list of stations and their respective channels.)

To ensure that your first download of data is complete, you should leave your TV off overnight. Downloads occur several times a day. *The TV must be turned off for GUIDE Plus+ data to download.*

If the TV loses power or is unplugged, GUIDE Plus+ Program information may be lost. When power is restored, make sure the setup information is still correct. The GUIDE Plus+ system will complete a download at the next available opportunity.

CHANNEL MAPPING

If more than one cable company services your area, you may be prompted with a Channel Mapping screen after the first GUIDE Plus+ download. You will need to identify your cable company by selecting the correct channel numbers for the stations in question.

- Use the left and right arrows to change the channel group and press OK when the correct channel group is highlighted.

THE DIFFERENT GUIDE Plus+ SYSTEM MENUS

The GUIDE Plus+ system offers seven different options on the Menu bar: Grid, Sort, News, Schedule, Messages, Editor, and Setup. To access the Menu bar:

1. Press GUIDE to bring up the GUIDE Plus+ screen.
2. Press MENU or use the up and down arrows to highlight the Menu bar. The Grid guide comes up by default.
3. Use the left and right arrows to access other menus.
4. Press OK, MENU, or use the down arrow to access the Menu options.

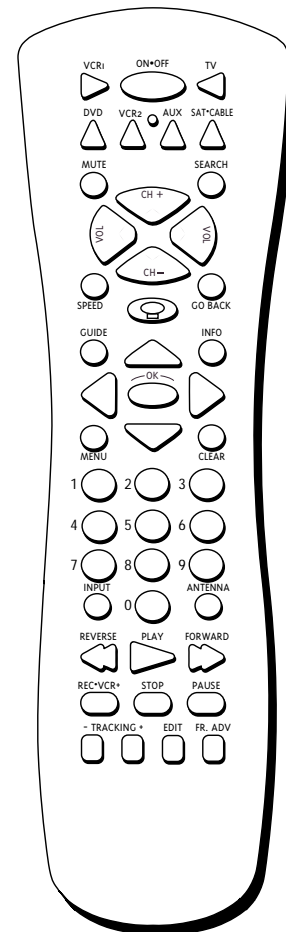

Press GUIDE on the remote control to see the GUIDE Plus+ system. To remove the program guide from the screen, press OK, GUIDE, or CLEAR.

FEATURES AND CONTROLS

GRID GUIDE

The Grid guide appears each time you enter the GUIDE Plus+ system. It displays the current programming for each channel. The live program is displayed in the video window.

- Use the up and down arrows to browse Channel listings and CH ^ and v to page through listings. Use the right and left arrows to browse future Program listings.
- To tune to a channel, highlight the program you want to view in the Channel listing and press OK. Press CLEAR to exit the GUIDE Plus+ system and return to the original channel. Press GUIDE to exit the GUIDE Plus+ system and tune to the channel in the background.

Grid Guide Action Buttons

Action buttons will change according to where you are in the GUIDE Plus+ system. Be sure to look at the Action bar before pressing the command numbers.

When highlighting the Channel listings, the following Action buttons are available on the bar:

1 ● Watch 2 ● GoTo 3 ● Record

- **Watch** Press 1 on the remote to place a timer in the Schedule for the TV to turn on and tune to the program highlighted in the Channel listing. When the TV turns on, the GUIDE Plus+ system will automatically appear with the scheduled program highlighted and tuned.
- **Go To** Press 2 on the remote to bring up the direct dial box and enter the number of the channel you want. This will highlight the channel and current program in the Channel listing of the Grid guide. Press OK to tune to the highlighted channel. If the video window is unlocked, you can press GUIDE to tune to the channel.
- **Record** Press 3 on the remote to place a timer in the Schedule for the VCR to record the program highlighted in the Channel listing. If you have a cable box, changing TV channels will not cause the cable box channel to change while recording.

The Program information window will display a confirmation when you have successfully created a timer to watch or record.

When highlighting Channel names (left column on the Channel listing), the following Action button is available on the bar:

1 ● Lock 2 ● GoTo 3 ●

- **Lock/Unlock** Press 1 to lock or unlock the video window to either stay at one channel as you browse the GUIDE Plus+ system (lock) or change as you browse through different channels (unlock).
- **Go To** Press 2 on the remote to bring up the direct dial box and enter the number of the channel you want. This will highlight the channel and current program in the Channel listing of the Grid guide. Press OK to tune to the highlighted channel. If the video window is unlocked, you can press GUIDE to tune to the channel.

Grid Guide Action Buttons



Grid Guide Menu Selection

FEATURES AND CONTROLS

SORT

The Sort menu lets you browse programs by category. The channel to which you are currently tuned is displayed in the background. To sort:

1. Press MENU to highlight the Menu bar.
2. Use the arrows to highlight *Sort*. When Sort is highlighted for the first time, the Movies category is displayed. Thereafter, the last category used becomes the default. A listing of subcategories is displayed below the category name.
3. Use the up and down arrows to highlight a subcategory. For example, highlight *All* and press OK.
4. When the listing comes up, movie topics are displayed on screen. Use the up and down arrows to browse the list one at a time. Use CH ^ and v to browse through the list one page at a time. You can also view the next seven days' programming by pressing the right arrow.
5. Select MENU to return to the Menu bar, or press GUIDE or CLEAR to exit the GUIDE Plus+ system.

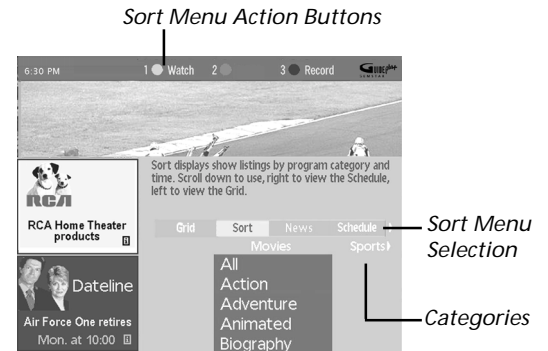

Sort Menu Action Buttons

When viewing the results of a Sort, the following Action buttons will appear on the bar:



- **Watch** Press 1 on the remote to place a timer in the Schedule, and then follow the on-line help for further options. Placing a timer in the Schedule will cause the TV to turn on and tune to the program highlighted in the Channel listing at the predetermined time. When the TV turns on, the GUIDE Plus+ system will automatically appear with the scheduled program highlighted and tuned in the background.
- **Record** Press 3 on the remote to place a timer in the Schedule for the VCR to record the program highlighted in the Channel listing. If you have a cable box, changing channels on the TV will not cause the cable box channel to change while recording.

The Program information window will display a confirmation when you have successfully created a timer to watch or record.

If you have selected two programs to watch or record which begin at the same time or overlap, you will receive a timer conflict message. The GUIDE Plus+ system will not schedule a conflicting timer, therefore, you must choose between the two programs.

FEATURES AND CONTROLS

News

The News menu lets you browse current news stories by headline.

1. Press GUIDE (the GUIDE Plus+ system appears). Then press MENU to select the menu bar.
2. Use the arrows to highlight *News*.
3. Use the up and down arrows to highlight a story.
 - Use the up and down arrows to browse one list at a time.
 - Use CH ^ and v to browse through the list one page at a time.
4. Press the right arrow button to see full text.
5. Select MENU to return to the Menu bar, or press GUIDE or CLEAR on the remote to exit the GUIDE Plus+ system.

Schedule

The Schedule menu lets you create timers for either viewing or recording programs. The GUIDE Plus+ system allows one-button recording. If you have a cable box, make sure you have connected the G-LINK cable to it. See the subsection "Step 5: Connect the G-Link Cable" in the section "Setup and Connections" for more details.

To schedule a program to watch or record:

1. Press GUIDE to bring up the GUIDE Plus+ system.
2. Highlight a program within the Channel listing.
3. Select Watch or Record from the Action buttons. The timer is then automatically logged into the Schedule menu.
4. If you select Record, make sure to place a blank tape in the VCR and leave the VCR turned off.

The Program information window will display a confirmation when you have successfully created a timer to watch or record.

If you have selected two programs to watch or record which begin at the same time or overlap, you will receive a timer conflict message. The GUIDE Plus+ system will not schedule a conflicting timer, therefore you must choose between the two programs.

To remove or change the frequency (daily, once, or weekly) of a scheduled event, access the Schedule menu from the Menu bar.

1. Press GUIDE to bring up the GUIDE Plus+ system.
2. Press MENU to highlight the Menu bar.
3. Use the arrows to highlight the *Schedule* menu selection.
4. Use the up and down arrows to highlight the program you want to edit. Then use the Schedule menu Action buttons as described in the next section.

Schedule Menu Action Buttons

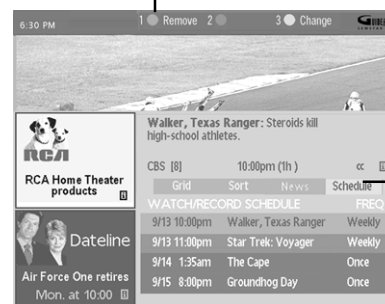

The GUIDE Plus+ system recording timer will override the VCR timer if you have set conflicting timers.

FEATURES AND CONTROLS

Schedule Menu Action Buttons

When viewing the Schedule menu the following Action buttons will appear on the bar:

1 ● Remove 2 ● 3 ● Change

- **Remove/Stop** Highlight the Watch or Record timer you wish to remove from the Schedule and press 1 on the remote.
- **Change** Highlight the Watch or Record timer you wish to change and press 3 on the remote to toggle the frequency between the following choices:
 - Daily** Records the same program each day Monday-Friday.
 - Once** Records only on that day.
 - Weekly** Records the program each week at the same time.

Messages

Occasionally you will receive messages regarding your GUIDE Plus+ system, as well as special programming information. You can access these messages from the Messages menu on the Menu bar.

To read messages:

1. Press MENU on the remote to select the Menu bar.
2. Use the arrows to highlight the *Messages* menu selection.
3. Highlight the message you wish to read by using the up and down arrows.
4. Press INFO to display the full text of the message. If the text continues beyond the screen, press INFO to view the next page of text. Once you have reached the end of the message, press INFO to close the expanded information and return to the Messages screen.
5. Then use the Messages menu Action button as described in the next section.

Messages Menu Action Button

When viewing the Messages menu, the following Action button will appear on the bar:

1 ● Remove 2 ● 3 ●

- **Remove** Highlight the message you wish to delete and press 1 on the remote.

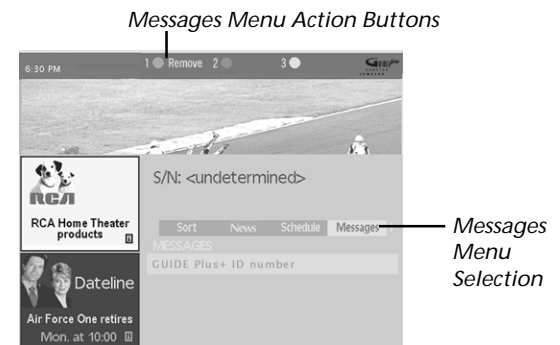

FEATURES AND CONTROLS

Editor

You may customize the Channel listing by enabling or disabling the display of certain channels. For instance, you may disable channels that you never watch. You can restore disabled channels at a later point in time.

1. Press GUIDE to bring up the GUIDE Plus+ system.
2. Press MENU to highlight the Menu bar.
3. Use the right and left arrows to highlight the *Editor* menu selection.
4. Use the up and down arrows to select a channel.

Then use the Editor menu Action buttons as described in the next section.

Editor Menu Action Buttons

While browsing the Editor menu, the following Action buttons are available on the bar:

1 ● Cancel 2 ● Change 3 ● On/Off

- **Cancel** Press 1 on the remote to cancel any changes made since entering the Editor menu.
- **Change** Press 2 on the remote to change the Channel number for the highlighted Channel line.
- **On/Off** Press 3 on the remote to toggle the state of the channel between On and Off.

Setup

The Setup menu lets you access GUIDE Plus+ system setup information. To access the Setup option:

1. Press MENU on the remote to highlight the Menu bar.
2. Press 5 to select the Setup menu selection.
3. Use the up and down arrows to select *Setup*, *View Demo*, or *Options*:
 - **Setup** Displays the GUIDE Plus+ system Setup screens. See the subsection "Step 8: Set Up the GUIDE Plus+ System" in the section "Setup and Connections" for more details.
 - **View Demo** Runs the GUIDE Plus+ system demonstration.
 - **Options** Displays the GUIDE Plus+ autodisplay options.

On Automatically displays the GUIDE Plus+ system when you use the TV button on the remote to turn on the TV.

Off Disables the GUIDE Plus+ system from being displayed when you use the TV button on the remote to turn on the TV.

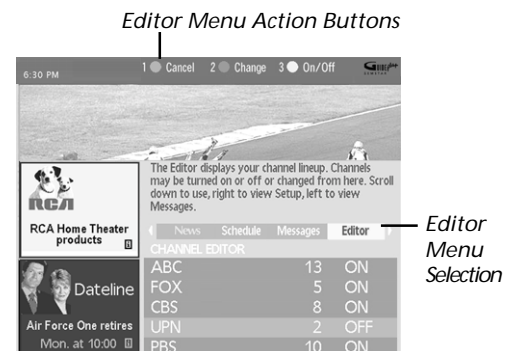

EXPANDED INFORMATION

To view more information about a program, advertisement, or special, highlight the Channel listing or ad/show information box and press the INFO button. Requesting more information about a particular show will also display the PlusCode programming number and the Shows on Next for that channel.

Pressing INFO while highlighting an ad panel will fill the screen with any additional and/or promotional information regarding that particular program.

Pressing the INFO button again exits the expanded information screen.

REFERENCE

GETTING ASSISTANCE

This section provides information you may need for guidance while using your TV/VCR. It gives you specific information about the front panel and back panel, care and cleaning information, a limited warranty, and an index.

1 SETUP AND CONNECTIONS



2 USING THE REMOTE



3 OPERATING INSTRUCTIONS



4 FEATURES AND CONTROLS



5 REFERENCE

REFERENCE

FRONT PANEL

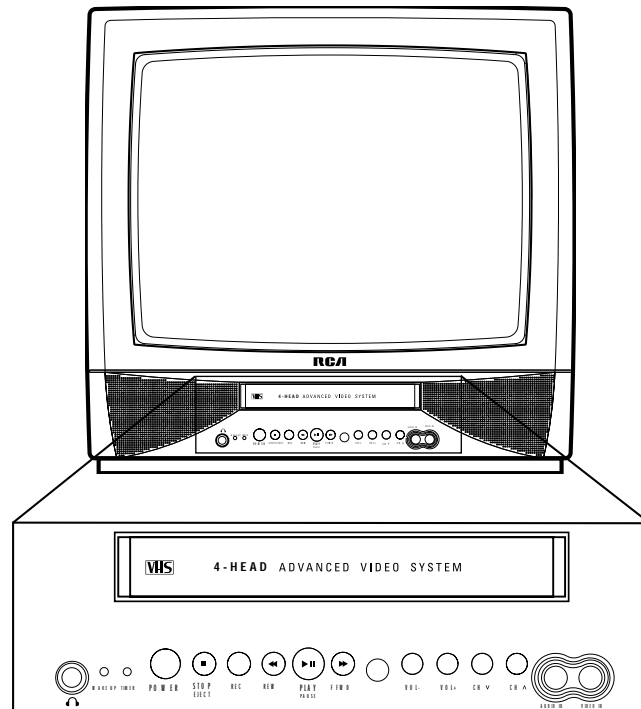

AUDIO IN and VIDEO IN Jacks Receives audio and video signals from another component (such as a VCR or camcorder) that is connected to these jacks. To select these front panel jacks, press 00 twice to display VIDEO 2.

CH ^ and v (Channel up and down) Selects next higher or lower channel in the TV/VCR's channel memory. Used for manual tracking when a tape is playing.

F. FWD (Fast Forward) Fast forwards the tape when the VCR is stopped. Searches the picture in forward motion during playback.

Headphone Jack Connect headphones (not supplied) to this jack.

PLAY/PAUSE Press once to begin playback of a tape. During playback, press to pause. Press again to resume playback.

POWER Turns the TV/VCR on or off. The indicator in the button lights when the power is on.

REC (Record) Press to start TV/VCR recording. The indicator in the button lights during recording.

Remote Sensor Receives signals from the remote. Aim remote at this sensor with no objects between them.

REW (Rewind) Rewinds the tape when the TV/VCR is stopped. Searches the picture in reverse during playback.

STOP/EJECT Stops normal functions such as record, play, rewind, fast-forward, or pause. Press when a tape is stopped to eject the cassette.

TIMER Indicator Lights when a timer program has been set and a cassette with safety tab in place is in the TV/VCR. Flashes when a timer recording has been set and the TV/VCR is turned off when no cassette has been inserted, a cassette with no safety tab has been inserted, or there has been a power interruption.

WAKE-UP Indicator Lights when the wake-up timer turns on the TV/VCR.

VOL + and - (Volume up and down) Raises and lowers the sound.

REFERENCE

BACK PANEL

To view the device you have connected to the AUDIO/VIDEO jacks, press 00 once to display VIDEO 1.

VIDEO and AUDIO INPUT Jacks

Receive signals from another component (such as a VCR or camcorder) that is connected to these jacks. Be aware that the back panel's Audio/Video jacks are disabled when you connect a device to the front panel's Audio/Video jacks.

IN FROM ANTENNA Jack

Receives the signal from an antenna or cable system.

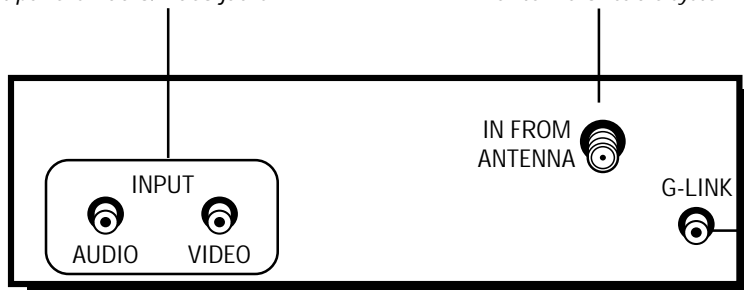

G-LINK Jack

Enables the TV/VCR's GUIDE Plus+ system to interact with your cable box (if you have one). Connect the end of the G-LINK cable (provided) to this jack.

Note that you must remove the demo pin from the G-LINK jack on the back of the TV/VCR before inserting the G-LINK cable.

TROUBLESHOOTING

Sometimes problems can be easily solved by checking a few basic things. Check below before you call for help or take your TV/VCR to an Authorized RCA VCR Service Center.

No power

- Plug TV/VCR into an operating outlet.
- Check connections.
- Make sure the wall outlet is not controlled by a wall switch.

TV/VCR does not respond to remote

- Aim remote at TV/VCR's remote sensor with no objects between them.
- Change batteries and make sure they are properly installed.

Poor or no picture during TV viewing

- Switch to an active channel.
- Check antenna connections. If using a dipole antenna, try adjusting its rods.
- Check picture adjustments.
- Make sure the line input is not selected. Repeatedly press 00 on the remote to switch between audio/video input jacks and tuner.

REFERENCE

No sound

- Press VOL ^ to increase the sound.
- Sound has been muted. Press MUTE or VOL ^ on remote.

Snow or streaks in picture or no picture during tape playback

- Check tape — it may be worn out or of poor quality. Try another tape.
- Some snow/streaks are normal during search, pause, frame advance, and slow-motion playback.
- Press one of the TRACKING buttons on the remote or CH ^ or v on the TV/VCR to move the streaks up or down and out of the picture.

Will not record or play

- No cassette in TV/VCR.
- Eject and re-insert cassette.
- Broken tape — try another cassette.
- Safety tab removed from cassette — TV/VCR will not record.
- TV/VCR is in pause mode. Press PAUSE on the remote.
- The GUIDE Plus+ system recording timer will override the VCR timer if you have set conflicting timers. If the VCR-timed recording is already in progress, it will be interrupted and the GUIDE Plus+ system-timed recording will begin as scheduled.

Cannot insert or eject tape

- Insert cassette with window facing up and safety tab facing out.
- To remove cassette, TV/VCR must be connected to working outlet.
- Turn POWER off and then on before trying to insert or remove cassette.

Time counter not working

- Press INFO on remote to display time counter on screen.
- The time counter does not advance during unrecorded portions of tape. When an unrecorded segment of tape is encountered, the time counter will hold its count until recorded material is detected again.
- A minus (-) will appear in front of the time counter if you rewind the tape farther back than a counter reading of 0:00:00.

Device connected to back panel A/V jacks will not work

- If you have a device connected to the front panel's Audio/Video jacks, the back panel Audio/Video jacks are disabled.

Timer recording not made or wrong program recorded; clock shows incorrect time or date

- Program entered incorrectly (wrong channel or times).
- Cable box was not turned on and tuned to the correct channel at time recording was to begin.
- Power interruption. TIMER indicator flashes on front of TV/VCR.
- Program exceeded tape's length or tape was not rewound beforehand.
- No tape in TV/VCR, or cassette ejected if safety tab broken off.
- Power interruption. TIMER REC indicator flashes on front of TV/VCR.
- Clock was not set accurately (check AM/PM and date).
- The GUIDE Plus+ system recording timer will override the VCR timer if you have set conflicting timers. If the VCR-timed recording is already in progress, it will be interrupted and the GUIDE Plus+ system-timed recording will begin as scheduled.

REFERENCE

TV/VCR makes noise when stopped

- TV/VCR is removing tape from heads. This is normal. The head cylinder inside the TV/VCR will continue to rotate for a few minutes after you put the VCR in the stop mode.

Will not Auto Channel Search active channels correctly

- Check antenna or cable connections.
- You cannot add or remove channels from the TV/VCR's memory if you're using a cable box and have set up the GUIDE Plus+ system.

Cannot see closed captions on screen

- Closed caption function must be set to On.
- Station may not be broadcasting closed captions.

Box appears on screen

- A text feature has been selected. To change the setting, press MENU on the remote, then press 1, then 2. Press 1 to change the Display and 2 to select the Mode. See page 35 for details.

TIMER indicator on front of TV/VCR is flashing

- Power interruption. Check time and date setting (clock).
- Timer program set and TV/VCR turned off with no cassette or cassette with no safety tab inserted.

Tape plays over and over

- Auto repeat is turned on.

Tape starts playing automatically

- Auto play feature is turned on.

Channel number displayed on screen does not change when I press CH ^ or v

- The on-screen channel number will always be the same as the channel number you've selected on the switch found on the rear of the cable box (channel 2, 3, or 4), regardless of the channel displayed on the cable box (the channel you're viewing). The channel number displayed on the cable box should change when you press CH ^ or v.

TV/VCR turns off automatically

- Sleep timer is turned on. Press TV or VCR to turn the TV/VCR back on. Remember that if you have set the sleep timer to activate any time during a GUIDE Plus+ system-timed recording, the sleep timer will not activate.

TV/VCR turns on automatically

- Wake-up timer (alarm) is turned on. Remember that if you have set the wake-up timer to activate any time during a GUIDE Plus+ system-timed recording, the wake-up timer will not activate.

Sleep timer or wake-up timer not working

- If you have set the sleep timer or wake-up timer to activate any time during a GUIDE Plus+ system-timed recording, the sleep timer or wake-up timer will not activate.

Cannot record one program while watching a different program

- TV/VCR only has one tuner. Only one program can be watched and recorded at the same time.

Parental Controls are not blocking programs

- Make sure Parental Control feature is turned on.

REFERENCE

Parental Control password does not work

- Reset Parental Control password.

Front panel buttons won't work

- When the GUIDE Plus+ system is recording, front panel buttons are inoperative.

Not receiving all cable channels

- Make sure you have set up the GUIDE Plus+ menu to recognize your cable box. Select *GUIDE Plus+ Menu* from the Main Menu, then select *Setup* from the GUIDE Plus+ menu. Choose *Yes* when asked if you have a cable box. Then select *Setup* from the Main Menu and run Auto Search. Also make sure you are using the G-LINK cable properly.

GUIDE Plus+ problems

- Check to make sure the G-LINK cable is attached correctly over the IR remote sensors on your cable box, that you have specified in the GUIDE Plus+ setup that you are using a cable box, and that you have completed the TV/VCR menu setup.
- Your remote may be interfering with the G-LINK cable. Place a piece of dark tape over the IR controller.
- GUIDE Plus+ system control of cable box is slower than direct control of the box when changing channels.
- You may have an incorrect GUIDE Plus+ Channel Map. The guide may get out of sync with the cable provider. Use the GUIDE Plus+ Setup feature to change the zip code to 99999. Turn the TV off for 10 minutes. Use Setup again to change the zip code back to the correct value. If asked, be sure to select the correct lineup.
- If you move or if any of your information changes, follow these steps: (1) Press MENU on the remote to display the TV/VCR Main Menu; (2) Press 6, then 1 to set up the GUIDE Plus+ system; (3) Press 5, then 1 to initiate Auto Channel Search.
- If the GUIDE Plus+ system appears when you play a tape, press the GUIDE or CLEAR button on the remote. The GUIDE Plus+ system will disappear in approximately one minute if you do not press any button.

Guide comes up when I turn on the TV/VCR

- You can turn off this feature by selecting *Setup* from the GUIDE Plus+ menu when the guide is available (press MENU and use the right arrow buttons) and then selecting *Options*. Choose *Off*.

SAT•CABLE button on remote doesn't work

- You must complete the GUIDE Plus+ setup, making sure to specify that you are using a cable box and that you have completed the TV/VCR setup.

CLEANING THE TV/VCR

Turn off the TV/VCR before cleaning.

You can clean the TV/VCR as required by using a soft cloth or the dusting attachment of your vacuum cleaner. Be sure to occasionally vacuum the ventilation slots in the cabinet to help assure adequate ventilation.

To clean the TV/VCR screen, use a soft cloth dampened with a diluted soap and water mixture. Do not use furniture polish on the TV/VCR cabinet or screen.

While cleaning, do not spray liquid directly on the screen or allow liquid to run down the screen or inside the TV/VCR. Also, avoid placing drinks or vases with water on top of the TV/VCR. This could increase the risk of fire, shock hazard, or damage to the TV/VCR.

REFERENCE

LIMITED WARRANTY

What your warranty covers:

- Any defect in material or workmanship.

For how long after your purchase:

- Ninety days for labor charges.
- One year for parts.
- Two years for picture tube.

(The warranty period for rental units begins with the first rental or 45 days from date of shipment to the rental firm, whichever comes first.)

What we will do:

- Pay any Authorized RCA VCR Service Center the labor charges to repair your TV/VCR.
- Pay any Authorized RCA VCR Service Center for the new or, at our option, rebuilt replacement parts and picture tube required to repair your TV/VCR.

How you get service:

- For screen sizes of 26" and smaller:
Take your RCA TV/VCR to any Authorized RCA VCR Service Center and pickup when repairs are complete.
- For screen sizes larger than 26": Request home service from any Authorized RCA VCR Service Center, provided that your TV/VCR is located within the geographic territory covered by an Authorized RCA VCR Service Center. If not, you must take your TV/VCR to the service center location at your own expense, or pay for the cost the service center may charge to transport your TV/VCR to and from your home.
- To identify your nearest Authorized RCA VCR-Service Center, ask your dealer, look in the Yellow Pages, or call 1-800-336-1900.
- Show the Authorized Service Center representative your sales receipt or other evidence of purchase date.

What your warranty does not cover:

- Customer instruction. (Your Owner's Manual clearly describes how to install, adjust, and operate your TV/VCR. Any additional information should be obtained from your dealer.)
- Installation and related adjustments.
- Signal reception problems not caused by your TV/VCR.
- Damage from misuse or neglect.
- Cleaning of video/audio heads.
- Batteries.
- A TV/VCR that has been modified or incorporated into other products or is used for institutional or other commercial purposes.
- Images burnt onto the screen.
- Acts of God, such as but not limited to lightning damage.
- A TV/VCR purchased or serviced outside the USA.

Product Registration:

- Please complete and mail the Product Registration Card packed with your set. It will make it easier for RCA to contact you should it ever be necessary. The return of the card is not required for warranty coverage.

How state law relates to this warranty:

- This warranty gives you specific legal rights, and you also may have other rights that vary from state to state.

If you purchased your TV/VCR outside the United States:

- This warranty does not apply. Contact your dealer for warranty information.

Service calls which do not involve defective materials or workmanship are not covered by this warranty. Costs of such service calls are the sole responsibility of the purchaser.

REFERENCE

Accessory Information

Antenna (or cable-TV) connections are made with either coaxial antenna cable or twin-lead cable. Coaxial cables are shielded so they are less susceptible to hum or interference from adjacent cables.

Most audio/video connections between components can be made with shielded audio and video cables that have RCA-type phono connectors.

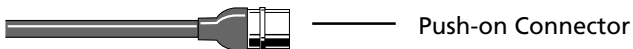

Push-on Connector

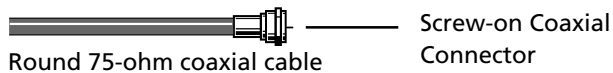

Round 75-ohm coaxial cable

Screw-on Coaxial Connector



Flat 300-ohm twin-lead cable



Standard Audio/Video cable with RCA-type phono plugs (such as No. VH83)

Color-Coded Jacks

The jacks on the TV's monitor panel are color-coded for ease of use. The video jacks are yellow, the right audio jacks are red, and the left audio jacks are white. When connecting components to each other, be sure that you always connect left outputs to left inputs and right outputs to right inputs. If a component has only one output (mono), connect it to the R/mono input jack.

To connect S-VHS (Super-VHS) components, an S-VHS video cable is required.



S-Video cable (such as No. VH913)

Gold-Plated Jacks and Gold-Tipped Cables

Gold plating helps prevent oxidation of contacts which provides much less loss than conventional contacts. A complete line of gold-tipped cables is available to help you obtain optimum performance from your equipment.

The following accessories are available from most dealers and electronics supply stores in case you want to position your components farther apart or need additional cables.

Antenna Cables

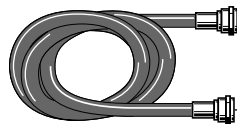

VH81 (3-ft)

VH82 (6-ft)



VH89 (6-ft)

Screw-on Cable attaches to the round antenna connectors (called 75-ohm F-type) on the back of your TV/VCR. The ends screw onto the connectors for a secure connection.

Push-on Cable attaches to the round antenna connectors (called 75-ohm F-type) on the back of your TV/VCR. The ends push on for a quick connection.

Audio/Video Cables

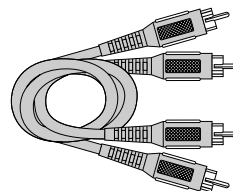

Gold-Tipped cable
VH83 (6-ft)

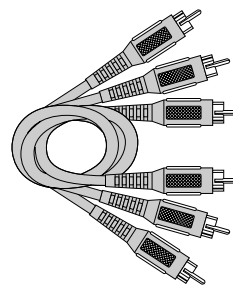

Gold-Tipped cable
VH84 (6-ft)

Monaural VCR Dubbing Cable lets you connect the video and audio jacks of two VHS VCRs to duplicate tapes. This double cable is color-coded and shielded and has RCA-type phono plugs on each end.

Stereo VCR Dubbing Cable lets you connect the VIDEO and AUDIO jacks of stereo components. This is a triple cable.

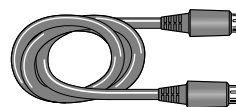

VH976 (6-ft)

VH913 (12-ft)

S-Video Cable has multi-pin connectors on each end for connecting S-Video components to your TV.

REFERENCE

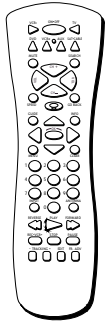

CRK76TRL1

Remote Control
replacements or spares can
be ordered as needed.

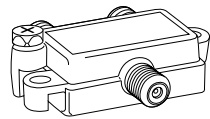

Splitter
VH47

2-way Signal Splitter
helps you connect to a
second TV or VCR.



ANT200

**Amplified VHF/UHF/FM
Antenna** allows you to
easily switch from the
antenna signal to cable or
satellite easily without
disconnecting antenna.

Accessory Order Form

Description	Part No.	Price	Qty
Screw-on antenna cable (3-ft)	VH81	\$3.95	
Screw-on antenna cable (6-ft)	VH82	\$5.95	
Push-on antenna cable (6-ft)	VH89	\$5.95	
Monaural VCR Dubbing Cable (6-ft)	VH83	\$5.95	
Stereo VCR Dubbing Cable (6-ft)	VH84	\$9.95	
S-Video Cable (6-ft)	VH976	\$7.95	
S-Video Cable (12-ft)	VH913	\$14.95	
2-way Signal Splitter	VH47	\$3.95	
Amplified Antenna	ANT200	\$49.95	
Antenna Mixer	193984	\$11.15	
Remote Control (CRK76TRL1)	243300	\$33.10	
Audio•Video Adapter	228449	\$4.45	

Total Merchandise	\$ _____
Sales Tax	\$ _____
We are required by law to collect the appropriate sales tax for each individual state, country, and locality to which the merchandise is being sent.	
Shipping and Handling	\$ 5.00
Total Amount Enclosed	\$ _____
Use VISA, MasterCard, or Discover Card preferably.	
Money order or check must be in U.S. currency only.	
No COD or CASH.	



Detach Here

All accessories are subject to availability.
Prices are subject to change without notice.
Where applicable, we will ship a superseding model.

Please complete other side also

REFERENCE

Charge your order on your VISA, MasterCard, or Discover Card by filling in below

USE YOUR CREDIT CARD

IMPORTANT: Copy complete account number from your VISA card



My card expires:

IMPORTANT: Copy complete account number from your MasterCard



Copy Number above your name on MasterCard

My card expires:

IMPORTANT: Copy complete account number from your Discover Card



My card expires:

AUTHORIZED SIGNATURE

(Credit card order will not be processed without signature)

Print or type your name and address clearly.



A complete and correct order will save you days of waiting.

Name: _____

Street: _____

_____ Apt: _____

City: _____

State: _____ Zip: _____

Daytime phone number: _____

Please make sure that both sides of this form have been filled out completely.

- Allow 4 weeks for delivery.
- All accessories are subject to availability.
- Prices are subject to change.

Placing an Order

To place your order by phone, have your Visa, MasterCard, or Discover Card ready and call the toll-free number listed below.

Use this number only to place an order for accessory items listed on this order form.

1-800-338-0376

To place your order by mail, detach and mail the completed order form with credit card information, money order or check in US currency (made payable to Thomson Consumer Electronics, Inc.) to the following address:

**Video Accessories
PO Box 8419
Ronks, PA 17573**

REFERENCE

INDEX

A

Accessories 58
Advance
 Frame 23
Advertisement
 GUIDE Plus+ system 50
Age-based ratings 40
AUDIO IN jacks 52
Auto play 25
Auto repeat 25
Autodisplay
 GUIDE Plus+ system 44, 50
Automatic
 Tracking 24
Automatic head cleaner 28

B

Back panel 53
Basic recording 29
Batteries for the remote 4
Blank search 27

C

Cable box 6
Camcorder 7
Camcorder hookup 5
Cleaning the VCR 56
Clock
 Setting 13
Closed captioning 35
Commercial
 Scan 24
Content themes 41
Copying tapes 7, 31
Counter
 Time 24

D

Date
 Setting 14
Dipole antenna 5

E

Edit
 GUIDE Plus+ system 50
Editing tapes 31
Editor
 GUIDE Plus+ system 50
Express recording 29

F

Finding the sensor 8
First time TV/VCR is turned
 on 9
Frame advance 23
Front panel 52

G

G-LINK cable 4, 8
GUIDE Plus+ system 9, 44
 Channel mapping 45
 Edit 50
 Editor 50
 Getting out 11
 Grid guide 46
 News 48
 Schedule 48
 Setup 9
 Sort 47

H

Head cleaner 28
Hooking up the TV/VCR 4

I

Index search 26

L

Language
 Selecting 12
Limited warranty 57
Lock parental controls 43

M

Memory
 Adding and removing
 channels 13
 Channel 12
Menus
 GUIDE Plus+ system 9
Movie rating limits 42

N

News
 GUIDE Plus+ system 48

O

On-screen displays 34
Outside antenna 5

P

Parental controls 38
 Lock/Unlock 43
Pause 23
 Recording 28
Picture
 Search 23
Play
 Auto 25
Play a tape 22

R

Rating limits 39
 Content themes 41
 Movie 42
 Unrated programs 43
Ratings
 Age-based 40
Recording 28
 Basic 29
 Express 29
 Pause 28
 Speeds 28
 Timer 30
Remote control sensor 8, 52
Repeat
 Auto 25

S

Schedule
 GUIDE Plus+ system 48
Search
 Blank 27
 Index 26
 Picture 23
 Zero 27
Set-top antenna 5
Setup
 GUIDE Plus+ system 9, 50
Signal type 13
Sleep timer 36
Slow motion 23
Sort
 GUIDE Plus+ system 47
Speeds
 Recording 28

T

Time
 Counter 24
 Setting 14
Timer
 Sleep 36
 Wake-up 36
Timer indicator 52
Timer recording 30
Tracking 24
Troubleshooting 53
Turning off
 GUIDE Plus+ system on
 startup 44, 50

U

Unlock parental controls
 43
Unrated TV programs 43

V

V-Chip 38
VCR controller 4
Video
 Adjusting 34
Volume
 Adjusting 14

W

Wake-up indicator 52
Wake-up timer 36
Warranty 57

Z

Zero search 27

Please do not send any products to the Indianapolis address listed in this manual or on the carton. This will only add delays in service for your product.

 **THOMSON CONSUMER ELECTRONICS**
10330 North Meridian Street
Indianapolis, IN 46290

©2000 Thomson Consumer Electronics, Inc.
Trademark(s)® Registered
Marca(s) Registrada(s)
Printed in Thailand
TOCOM 15392230

The following materials were used in printing this publication:



60%
RECYCLED PAPER
MINIMUM 20% POST CONSUMER



Free Manuals Download Website

<http://myh66.com>

<http://usermanuals.us>

<http://www.somanuals.com>

<http://www.4manuals.cc>

<http://www.manual-lib.com>

<http://www.404manual.com>

<http://www.luxmanual.com>

<http://aubethermostatmanual.com>

Golf course search by state

<http://golfingnear.com>

Email search by domain

<http://emailbydomain.com>

Auto manuals search

<http://auto.somanuals.com>

TV manuals search

<http://tv.somanuals.com>