

RCA

TV/VCR/DVD User's Guide

Changing Entertainment. Again.



WARNING

TO REDUCE THE RISK OF FIRE OR ELECTRIC SHOCK, DO NOT EXPOSE THIS PRODUCT TO RAIN OR MOISTURE.

CAUTION

THIS PRODUCT UTILIZES A LASER. USE OF CONTROLS OR ADJUSTMENTS OR PERFORMANCE OF PROCEDURES OTHER THAN THOSE SPECIFIED HEREIN MAY RESULT IN HAZARDOUS RADIATION EXPOSURE. DO NOT OPEN COVERS AND DO NOT REPAIR YOURSELF. REFER SERVICING TO QUALIFIED PERSONNEL.

Note:

This DVD player is designed and manufactured to respond to the Region Management Information. If the Region number of a DVD disc does not correspond to the Region number of this DVD player, this DVD player cannot play the disc. The Region number for this DVD player is Region No 1.

Note:

This device is protected by U.S. patent numbers 4,631,603 and 4,577,216 and 4,819,098 and other intellectual property rights. The use of Macrovision's copy protection technology in the device must be authorized by Macrovision and is intended for home and other limited pay-per-view uses only, unless otherwise authorized in writing by Macrovision. Reverse engineering or disassembly is prohibited.



Information

This equipment has been tested and found to comply with the limits for a Class B digital device, pursuant to Part 15 of the FCC Rules. These limits are designed to provide reasonable protection against harmful interference in a residential installation. This equipment generates, uses and can radiate radio frequency energy and, if not installed and used in accordance with the instructions, may cause harmful interference to radio communications. However, there is no guarantee that interference will not occur in a particular installation. If this equipment does cause harmful interference to radio or television reception, which can be determined by turning the equipment off and on, the user is encouraged to try to correct the interference by one or more of the following measures:

- Reorient or relocate the receiving antenna.
- Increase the separation between the equipment and receiver.
- Connect the equipment into an outlet on a circuit different from that to which the receiver is connected.
- Consult the dealer or an experienced radio/TV technician for help.

Product Registration

Please fill out the product registration card (packed separately) and return it immediately. Returning the card allows us to contact you if needed.

Product Information

Keep your sales receipt to obtain warranty parts and service and for proof of purchase. Attach it here and record the serial and model numbers in case you need them. These numbers are located on the product.

Model No. _____ Serial No. _____ Purchase Date: _____
Dealer/Address/Phone: _____

CAUTION

RISK OF ELECTRIC SHOCK
DO NOT OPEN

CAUTION: TO REDUCE THE RISK OF ELECTRIC SHOCK, DO NOT REMOVE COVER (OR BACK). NO USER SERVICEABLE PARTS INSIDE. REFER SERVICING TO QUALIFIED SERVICE PERSONNEL.



This symbol indicates "dangerous voltage" inside the product that presents a risk of electric shock or personal injury.



This symbol indicates important instructions accompanying the product.

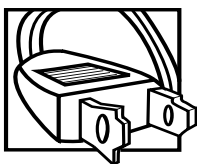

Caution: To prevent electric shock, match wide blade of plug to wide slot, fully insert.

Attention: Pour éviter les chocs électriques, introduire la lame la plus large de la fiche dans la borne correspondante de la prise et pousser jusqu'au fond.

Refer to the identification/rating label located on the back panel of your product for its proper operating voltage.

FCC Regulations state that unauthorized changes or modifications to this equipment may void the user's authority to operate it.

This Class B digital apparatus complies with Canadian ICES-003.

Caution: Using video games or any external accessory with fixed images for extended periods of time can cause them to be permanently imprinted on the picture tube (or projection TV picture tubes). ALSO, some network/program logos, phone numbers, etc. may cause similar damage. This damage is not covered by your warranty.





Cable TV Installer: This reminder is provided to call your attention to Article 820-40 of the National Electrical Code (Section 54 of the Canadian Electrical Code, Part 1) which provides guidelines for proper grounding and, in particular, specifies that the cable ground shall be connected to the grounding system of the building as close to the point of cable entry as practical.

IMPORTANT SAFEGUARDS

In addition to the careful attention devoted to quality standards in the manufacture of your product, safety is a major factor in the design of every product. However, safety is your responsibility too.

This sheet lists important information that will help to assure your enjoyment and proper use of the product and accessory equipment. Please read them carefully before operating and using your product.

Installation

- 1 Read and Follow Instructions**—All the safety and operating instructions should be read before the product is operated. Follow all operating instructions. 
- 2 Retain Instructions**—The safety and operating instructions should be retained for future reference.
- 3 Heed Warnings**—Comply with all warnings on the product and in the operating instructions.
- 4 Polarization/Grounding**—This product is equipped with either a polarized, non-polarized, or a grounding type power cord plug. If equipped with the non-polarized type (two blades of identical size), the following does not apply.
 - A polarized power plug (two blades, one wider than the other) will fit into a power receptacle only one way. This is a safety feature. Do not defeat it. If you are unable to insert the plug fully, try reversing it, or have an electrician change the receptacle. If you need an extension cord, use only a polarized extension cord. 
 - A grounding type power plug (two blades and a round pin) will fit only into a grounding type receptacle with matching openings. This is a safety feature. Do not defeat it. You may need an electrician to install a grounding type receptacle. If you need an extension cord, use only a grounding type extension cord. 
- 5 Power Sources**—This product should be operated only from the type of power source indicated on the product's marking label. If you are not sure of the type of power supply to your home, consult your dealer or local power company. For products intended to operate from battery power, or other sources, refer to the operating instructions.
- 6 Overloading**—Do not overload wall outlets or extension cords as this can result in a risk of fire or electric shock. Overloaded AC outlets, extension cords, frayed power cords, damaged or cracked wire insulation, and broken plugs are dangerous. They may result in a shock or fire hazard. Periodically examine the cord, and if its appearance indicates damage or deteriorated insulation, have it replaced by your service technician. 
- 7 Power-Cord Protection**—Power-supply cords should be routed so that they are not likely to be walked on or pinched by items placed upon or against them. Pay particular attention to cords where they are attached to plugs, convenience receptacles and at the point where they exit from the product.
- 8 Ventilation**—Slots and openings in the enclosure are provided for ventilation to ensure reliable operation of the product and to protect it from overheating. These openings must not be blocked or covered. These openings should never be blocked by placing the product on a bed, sofa, rug, or other similar surface. This product should never be placed near or over a radiator or heat register, or another heat source (including amplifiers). This product should not be placed in a built-in installation such as a bookcase or equipment rack unless proper ventilation is provided or the product manufacturer's instructions have been followed.
- 9 Attachments**—Do not use attachments unless recommended by the product manufacturer as they may cause hazards.
- 10 Water and Moisture**—Do not use this product near water—for example, near a bath tub, wash bowl, kitchen sink or laundry tub, in a wet basement, or near a swimming pool and the like.
- 11 Accessories**—Do not place this product on an unstable surface or support. The product may fall, causing serious injury to a child or adult as well as serious damage to the product. Any mounting of the product should follow the manufacturer's instructions and use only a mounting accessory recommended by the manufacturer.

IMPORTANT SAFEGUARDS



11A A product and cart combination should be moved with care. Quick stops, excessive force, and uneven surfaces may cause the product and cart combination to overturn.

12 Outdoor Antenna Grounding—If an outside antenna or cable system is connected to the product, be sure the antenna or cable system is grounded so as to provide some protection against voltage surges and built-up static charges. Section 810 of the National Electrical Code, ANSI/NFPA No. 70-1984 (Section 54 of Canadian Electrical Code, Part 1) provides information with respect to proper grounding of the mast and supporting structure, grounding of the lead-in wire to an antenna-discharge unit, size of grounding conductors, location of antenna-discharge unit, connection to grounding electrodes, and requirements for the grounding electrode. See following example.

Example of Antenna Grounding

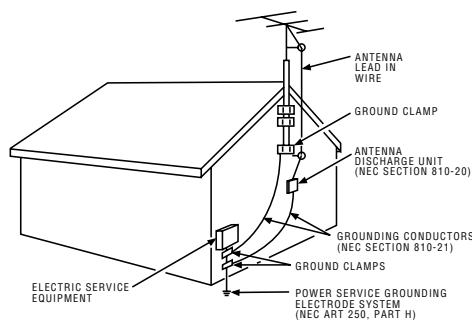

13 Power Lines—An outside antenna system should not be located in the vicinity of overhead power lines, other electric light or power circuits, or where it can fall into such power lines or circuits. When installing an outside antenna system, extreme care should be taken to keep from touching or approaching such power lines or circuits as contact with them might be fatal. Installing an outdoor antenna can be hazardous and should be left to a professional antenna installer.

Use

14 Cleaning—Unplug this product from the wall outlet before cleaning. Do not use liquid cleaners or aerosol cleaners. Use a damp cloth for cleaning.

15 Object and Liquid Entry—Never push objects of any kind into this product through openings as they may touch dangerous voltage or “short-out” parts that could result in a fire or electric shock. Never spill liquid of any kind on the product.

16 Lightning—For added protection for this product during a lightning storm, or when it is left unattended and unused for long periods of time, unplug it from the wall outlet and disconnect the antenna or cable system. This will prevent damage to the product due to lightning and power line surges.



Service

17 Servicing—Do not attempt to service this product yourself as opening or removing covers may expose you to dangerous voltage or other hazards. Refer all servicing to qualified service personnel.

18 Conditions Requiring Service — Unplug this product from the wall outlet and refer servicing to qualified service personnel under the following conditions.

- A. When the power-supply cord or plug is damaged.
- B. If liquid has been spilled, or objects have fallen into the product.
- C. If the product has been exposed to rain or water.

IMPORTANT SAFEGUARDS

- D. If the product does not operate normally by following the operating instructions. Adjust only those controls that are covered by the operating instructions. Improper adjustment of other controls may result in damage and will often require extensive work by a qualified technician to restore the product to its normal operation.
 - E. If the product has been dropped or the cabinet has been damaged.
 - F. When the product exhibits a distinct change in performance, such as the inability to perform basic functions—this indicates a need for service.
- 19 Replacement Parts**—When replacement parts are required, have the service technician verify that the replacement parts he uses have the same safety characteristics as the original parts. Use of replacements specified by the product manufacturer can prevent fire, electric shock, or other hazards.
- 20 Safety Check**—Upon completion of any service or repairs to this product, ask the service technician to perform safety checks recommended by the manufacturer to determine that the product is in safe operating condition.

Power Source

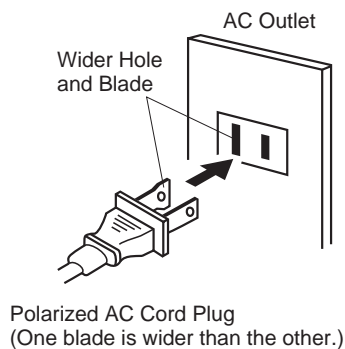

TO USE AC POWER SOURCE

Use the AC polarized line cord provided for operation on AC. Insert the AC cord plug into a standard 120V 60Hz polarized AC outlet.

NOTES:

- Never connect the AC line cord plug to other than the specified voltage (120V 60Hz). Use the attached power cord only.
- If the polarized AC cord does not fit into a non-polarized AC outlet, do not attempt to file or cut the blade. It is the user's responsibility to have an electrician replace the obsolete outlet.
- If you cause a static discharge when touching the unit and the unit fails to function, simply unplug the unit from the AC outlet and plug it back in. The unit should return to normal operation.

Important Stand and Base Safety Information

Choose the location for your TV carefully. Place the TV on a stand or base that is of adequate size and strength to prevent the TV from being accidentally tipped over, pushed off, or pulled off. This could cause personal injury and/or damage to TV. Refer to the Important Safety Instructions on page 3 of this manual.

Features

Color TV with DVD/CD Player/Video Cassette Recorder

- **Color TV with DVD/CD player with Video Cassette Recorder** - Unique space saving design combines a color TV, a DVD/CD player and a Hi-Fi Video cassette recorder. The DVD disc has much more capacity, but is the same size as the audio CD disc. Picture quality is higher than Super VHS. Audio quality is higher than audio CD. The DVD PLAYER can play back audio CDs.
- **High Quality Picture** - More than 400 lines (VCR mode: 220 lines) of Horizontal Resolution.

TV Section

- **On-Screen 3 Language Display** - You can select one of 3 languages, English, Spanish or French for on-screen programming.
- **Closed Caption Decoder With Full Text Mode** - Displays text captions or full screen text on the screen for hearing impaired viewers.
- **Picture Adjustments Using The Remote Control** - The On-Screen display allows precise remote control adjustment of BRIGHTNESS, CONTRAST, COLOR, TINT and SHARPNESS.
- **Programmable TV Sleep Timer** - Operable from the remote control, the TV can be programmed up to 120 minutes to turn off automatically.
- **V-Chip** - The V-Chip function can read the rating of a TV program or movie content if the program is encoded with this information. V-Chip will allow you to set a restriction level.
- **Surround Sound** - The surround sound feature expands the audio listening field wider and deeper to create exceptional sound quality from the TV's speakers.
- **Stable Sound** - The stable sound feature limits the highest volume level to prevent extreme changes in volume when the signal source is changed.

VCR Section

- **Stereo/SAP Reception** - This VCR is designed to receive stereo and second audio program (SAP) broadcasts where available.
- **4 Video Heads** - Provides optimal picture quality for special effects playback.
- **19µm HEAD** - For superior picture quality even in SLP mode, 19micron width technology helps to avoid crosstalk and boost SLP picture quality to near SP levels. With precision technology, ghosts and color beats are virtually eliminated.
- **Hi-Fi Stereo Sound** - With a frequency response of 20 to 20,000 Hz and a dynamic range of better than 90dB, this VCR provides a level of excellence that rivals compact discs.
- **One-touch Timer Recording (OTR)** - Simply by pressing the REC/OTR button, the VCR can be programmed for up to 6 hours of recording with an immediate start.

DVD Section

- **Compatible with a wide range of DVD audio outputs**

Digital Audio Jack:

- When a component with a built-in Dolby Digital decoder is connected, Dolby Digital sound can produce the effect of being in a movie theater or a concert hall.
- Surround standard different from Dolby Digital. This format is already in use in many theaters. By connecting this unit to a DTS decoder or an AV amplifier with a built-in DTS decoder, the DTS audio of DVD discs recorded in this format can be enjoyed. However, audio will not be output from the analog audio output jacks.
- The MPEG audio of DVD discs recorded in this format can be enjoyed.
- The Linear PCM sound of a 48 kHz/16 bit through 96 kHz/24 bit exceeds audio CD sound.
- **Multi-Language** - Since this DVD matches with 136 language-subtitles/-soundtracks, you can enjoy selecting a favorite one. (You cannot select the language that is not recorded on the disc.)
- **Multi-Angle** - Pictures of Sports or a Live Concert are recorded with many cameras. When you play such a disc, you can change the angles during playback. (If a Multi-Angle is not recorded on the disc, you cannot change the angle.)
- **Repeat Playback** - You can repeat chapter, track, title, sides or material between two selected points.
- **Memory/Random Playback** - You can play back tracks, titles or chapters in programmed or random-selected sequences.
- **Zoom** - You can zoom in on the selected subject on the screen during playback.
- **Video Aspect Ratio** - You can change the aspect ratio of the screen for your monitor/television on a suitable disc.
- **Parental Control** - You can limit the playback of scenes or sounds of adult DVD discs which have a parental level rating.

* This product incorporates copyright protection technology that is protected by method claims of certain U.S. patents and other intellectual property rights owned by Macrovision Corporation and other rights owners. Use of this copyright protection technology must be authorized by Macrovision Corporation, and is intended for home use only unless otherwise authorized by Macrovision Corporation. Reverse engineering or disassembly is prohibited.

* Manufactured under license from Dolby Laboratories. "Dolby" and the double-D symbol are trademarks of Dolby Laboratories. Confidential unpublished works. © 1992-1997 Dolby Laboratories, Inc. All rights reserved.

* "DTS" and "DTS Digital Out" are trademarks of Digital Theater Systems, Inc.

* Unauthorized recording of copyrighted television programs, films, video cassettes and other materials may infringe the rights of copyright owners and be contrary to copyright laws.

Contents

Before using your unit

IMPORTANT SAFEGUARDS	3
Power Source	5
Features	6
Contents	7
Parts and functions	8
Remote control	9
Antenna connections	11
Cable TV connections	12
Connections to other equipment	13
Setting the language	15
Auto clock setting	16
Manual clock setting	18

TV operation

TV operation	19
Closed caption	21
To memorize channels	22
Setting the V-Chip	24
To set the on timer	27
To set the off timer	28
Picture control adjustment	29
Sound control adjustment	30

Tape playback operation

Loading and Unloading a cassette tape	31
Cassette tape playback	32
Special playback	33
ZERO RETURN function	34
Video index search system	34

Recording

Recording a TV program	35
One-touch Timer Recording (OTR)	37
Timer recording	38

Advanced function of VCR section

Setting the surround sound	40
Setting the stable sound	40
Stereo recording and playback	41
Second Audio Program (SAP)	41
Duplicating a video tape	42

Disc playback operation

Disc	43
Preparation	44
Status display of disc	44
Playback procedure	45
Special playback	46
mp3 playback	47
Zooming	48
Locating desired scene	48
Repeat/Random/Program playback and Repeat A-B	49
Changing soundtrack language	50
Subtitles	50
Changing angles	51
Title selection	51
DVD menu	51

Advanced function of DVD section

Setting language	52
Setting the aspect ratio of TV screen	53
Setting on screen display	53
Dynamic Range Control	54
Parental control setting	55
To change parental level	56
Temporary disabling of rating by DVD disc	57

Additional information

Language code list	58
Problems and troubleshooting	59
Video head cleaning	60
Specifications	61
Warranty	62

Parts and functions

Front

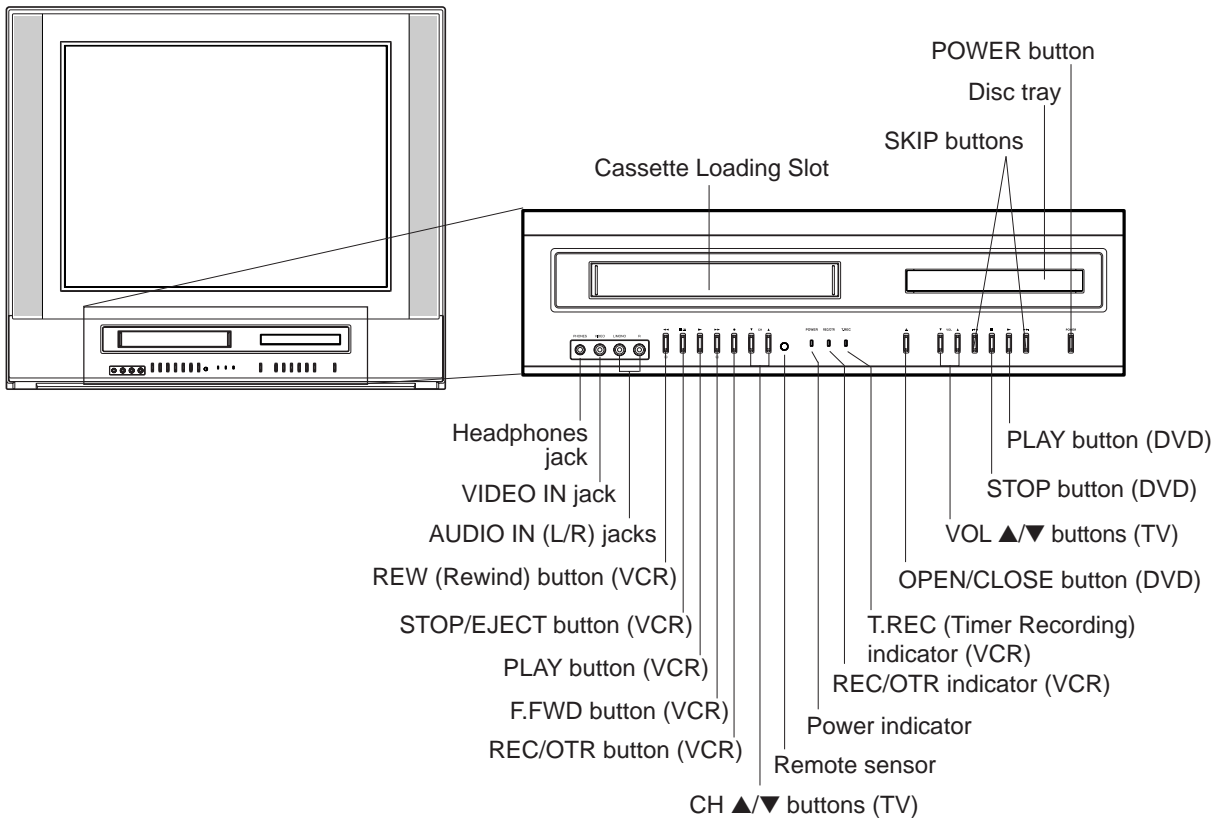

Rear

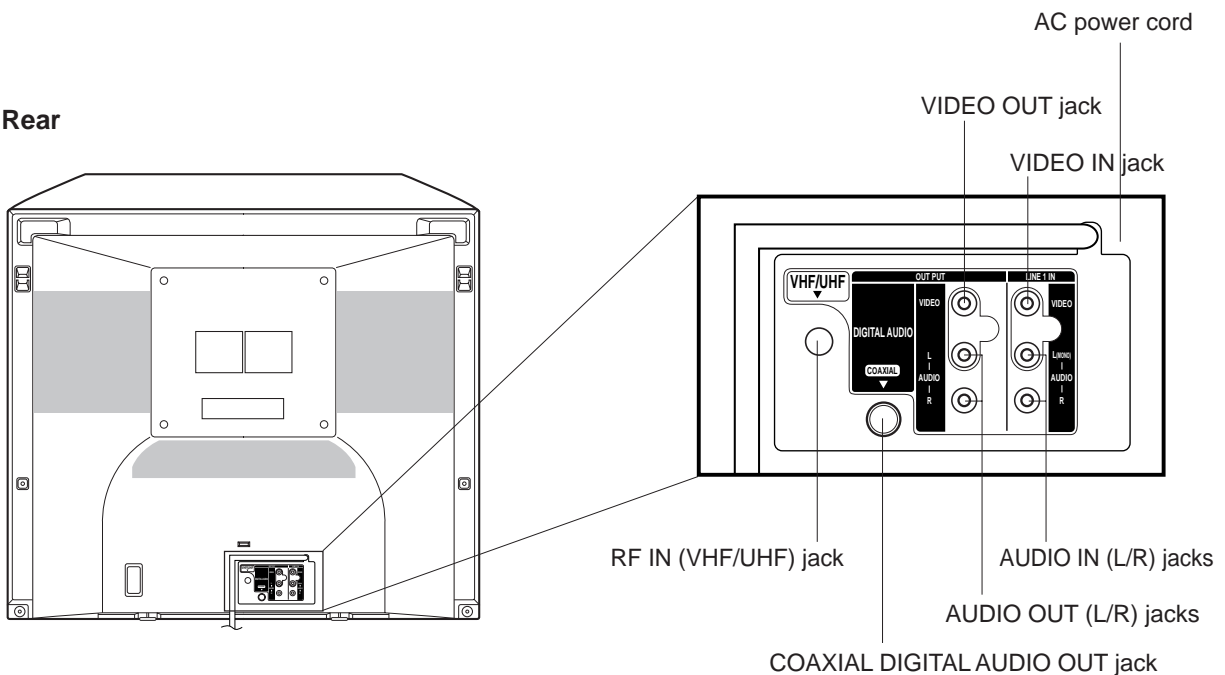

Remote control

Button descriptions (top left to right)

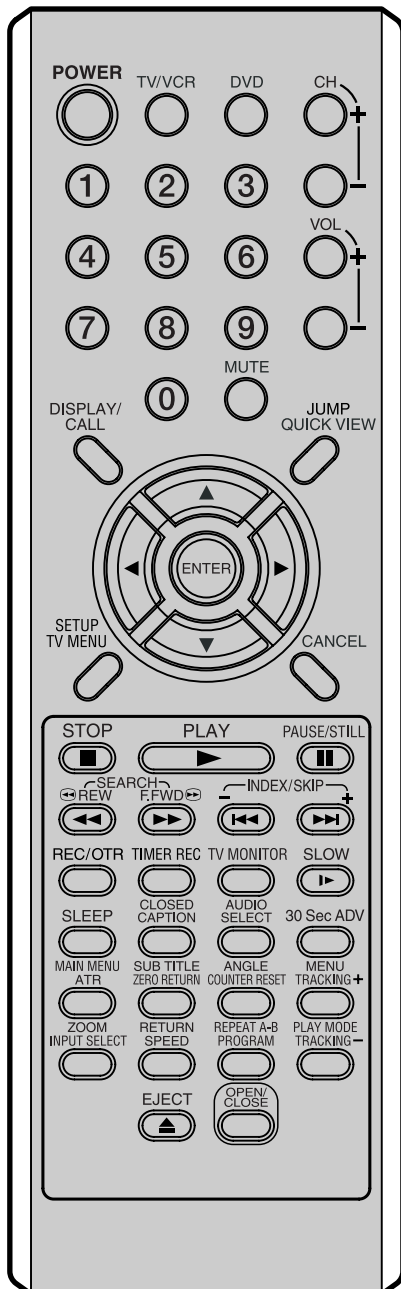

		Page
POWER	Power on/off	15
TV/VCR	Press to operate TV/VCR	15
DVD	Press to operate DVD	44
CH +/-	Select channel	20,35,37
0-9	Number buttons	19,23,35
	Input setting	48,49
	Enter a password	24,26,55-57
VOL +/-	Adjust volume of TV	19
MUTE	Switch off the sound	20
DISPLAY/CALL	Display TV/VCR or DVD operation status	16,20,34,36,44
JUMP	Locate the desired scene	48
QUICK VIEW	Switch between present/last channel	20
▲ / ▼ / ◀ / ▶	Arrow buttons for navigation	15,45
ENTER	Enter information in the menu	15
	Select option in the menu	45
SETUP/TV MENU	Display menu of setup	15,52-56
	Removes DVD set up menu	52-56
CANCEL	Delete Timer program	27,28,39
	Cancel input data in the setting mode	18,24,26,48,49,55,56
STOP	Stop	32,36,37,45
PLAY	Playback	32,45
PAUSE/STILL	Still picture/Recording pause on/off	33,36,46
REW/SEARCH	Rewind/Review playback	32,33,46
F.FWD/SEARCH	Fast Forward/Forward search playback	32,33,46
INDEX +/-	Search for the INDEX mark of a tape	34
SKIP +/-	Skip chapter to forward or reverse direction	46
REC/OTR	Recording	35,37
TIMER REC	Set the unit to start recording at a preset time	38,39
TV MONITOR	Temporarily watch a TV channel while playing a VCR tape.	33
SLOW	Slow-motion playback	33,46
SLEEP	Sleep timer	20
CLOSED CAPTION	Switch between TV/Caption/Text in Closed Caption mode	21
AUDIO SELECT	Switches sound between mono and stereo	41
	Change sound track language of DVD	50
30 Sec ADV	Skip the unwanted short material of a tape	33
MAIN MENU	Select title of a DVD disc	51
ATR	Digital AUTO TRACKING (VCR)	33
SUB TITLE	Set Subtitle of a DVD disc	50
ZERO RETURN	Stop the tape when the counter reaches 00:00:00	34
ANGLE	Change playback angle of a DVD disc	51
COUNTER RESET	Reset the counter to 00:00:00	34
MENU	Select menu of a DVD disc	51
TRACKING +	Manual tracking button in playback mode	33
ZOOM	Zoom (for DVD playback)	48
INPUT SELECT	Switch the connected TV to external mode	14
RETURN	Takes you to the previous menu	52-57
SPEED	Sets the tape speed for recording	35,37
REPEAT A-B	Repeat playback between A and B (DVD/CD)	49
PROGRAM	Confirm the timer program	28,39
PLAY MODE	Select playback mode	49
TRACKING -	Manual tracking button in playback mode	33
EJECT	Eject a cassette tape	31
OPEN/CLOSE	Open or Close the disc tray	45

Inserting Batteries

- 1 Open the battery compartment cover in the direction of the arrow.
- 2 Install two "AAA" batteries paying attention to the polarity diagram in the battery compartment.
- 3 Replace the compartment cover.

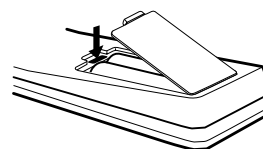
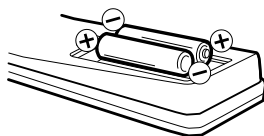
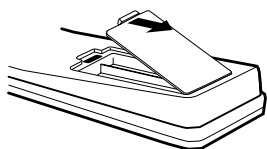

Battery precautions

The precautions below should be followed when using batteries in this device:

1. Use only the size and type of batteries specified.
2. Be sure to follow the correct polarity when installing the batteries as indicated in the battery compartment.
Reversed batteries may cause damage to the device. To avoid a potential short circuit, insert the "-" end first.
3. Do not mix different types of batteries together (e.g. Alkaline and Carbon-zinc) or old batteries with fresh ones.
4. If the device is not to be used for a long period of time, remove the batteries to prevent damage or injury from possible battery leakage.
5. Do not try to recharge batteries not intended to be recharged; they can overheat and rupture. (Follow battery manufacturer's directions.)

Remote control basics

- Press **POWER** to turn the unit on or off.
- Select your desired operating mode (TV/VCR or DVD) using **TV/VCR** or **DVD**.
- Press **CH +/-** to move through the channels one channel at a time.
- The **Arrow** buttons (**▲/▼/◀/▶**) are also used to navigate on-screen menu system.
- You can directly access specific channels using the **number buttons**.

Operation

- Aim the remote control at the remote sensor and press control buttons to operate.
- Operate the remote control within 30° angle on either side of the remote sensor, up to a distance of approximately 5 meters (16 ft.)

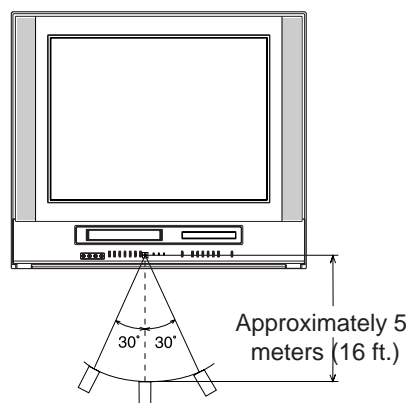

Antenna connections

If you are using an indoor or outdoor antenna, follow the instructions below that correspond to your antenna system. If you are using cable TV service (CATV), see page 12 for Cable TV connections.

Combination VHF/UHF Antenna (Single 75 ohm Cable or 300 ohm Twin-lead Wire)

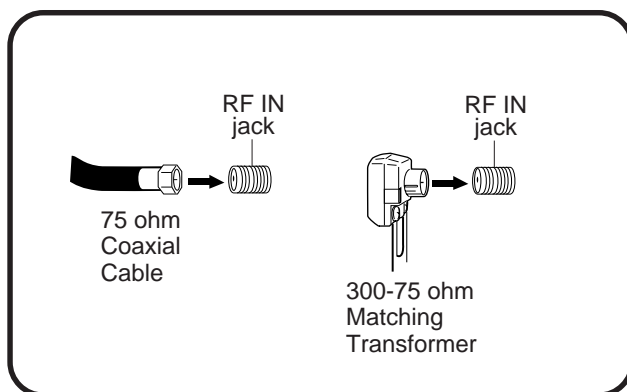

Connect the 75 ohm Cable from the Combination VHF/UHF Antenna to the RF IN Jack.

If your Combination VHF/UHF Antenna has a 300 ohm Twin-lead Wire, the use of the 300-75 ohm Matching Transformer may be necessary (not supplied).

Combination VHF/UHF Antenna (Separate VHF and UHF 300 ohm Twin-lead Wires)

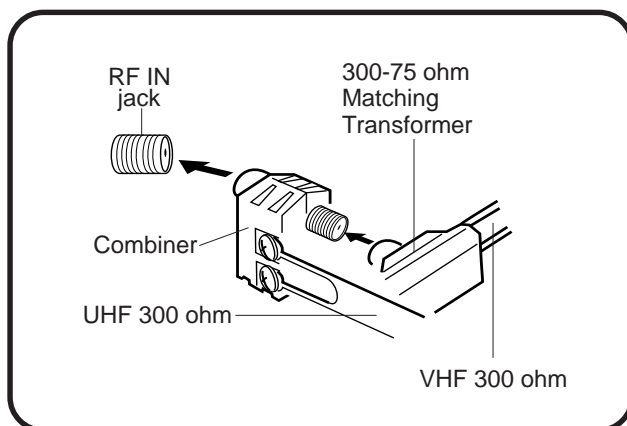

Connect the UHF 300 ohm Twin-lead Wire to the Combiner (not supplied). Connect the VHF 300 ohm Twin-lead Wire to the 300-75 ohm Matching Transformer. Attach the Transformer to the Combiner, then attach the Combiner to the RF IN Jack.

Separate VHF/UHF Antennas (75 ohm VHF Cable and 300 ohm UHF Twin-lead Wires)

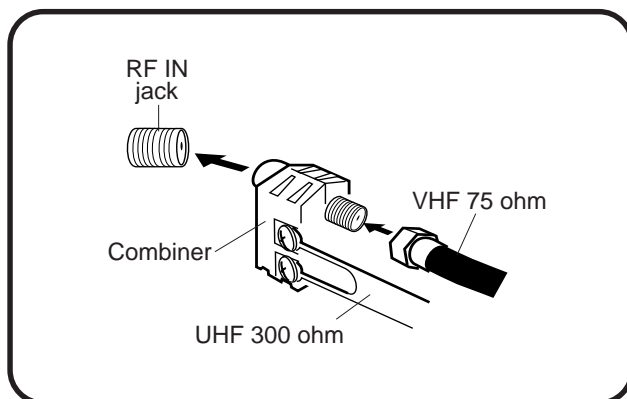

Connect the VHF 75 ohm cable and UHF 300 ohm Twin-lead Wire to the Combiner. Attach the Combiner to the RF IN Jack.

IMPORTANT: Go to page 22 to choose the signal and search for channels.

Cable TV connections

This unit has an extended tuning range and can tune most cable channels without using a Cable TV Converter box. Some cable companies offer "premium pay channels" in which the signal is scrambled. Descrambling these signals for normal viewing requires the use of a descrambler device which is generally provided by the cable company.

FOR SUBSCRIBERS TO BASIC CABLE TV SERVICE

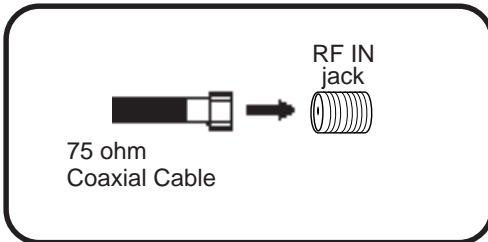

For basic cable service not requiring a Converter/Descrambler box, connect the CATV 75 ohm Coaxial Cable directly to the RF IN Jack on the back of the unit.

FOR SUBSCRIBERS TO SCRAMBLED CABLE TV SERVICE

If you subscribe to a cable TV service which requires the use of a Converter/Descrambler box, connect the incoming 75 ohm Coaxial Cable to the Converter/Descrambler box. Using another 75 ohm Coaxial Cable, connect the output jack of the Converter/Descrambler box to the RF IN Jack on the unit. Follow the connections shown below. Set the unit to the output channel of the Converter/Descrambler box (usually channel 3 or 4) and use the Converter/Descrambler box to select channels.

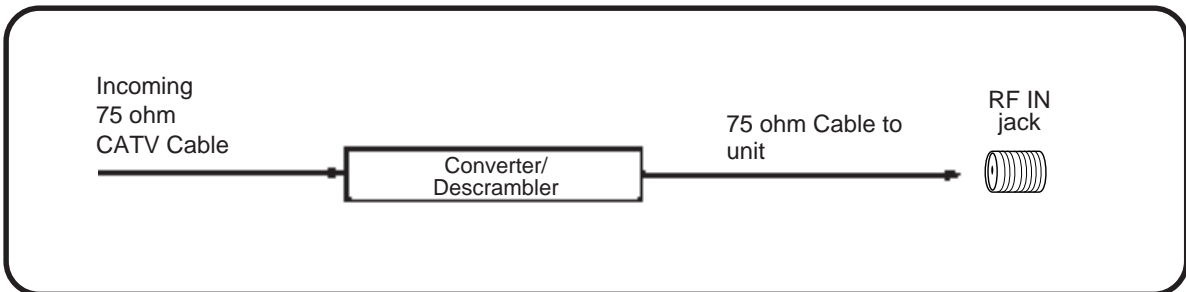

FOR SUBSCRIBERS TO UNSCRAMBLED BASIC CABLE TV SERVICE WITH SCRAMBLED PREMIUM CHANNELS

If you subscribe to a cable TV service in which basic channels are unscrambled and premium channels require the use of a Converter/Descrambler box, you may wish to use a signal Splitter and an A/B Switch box (available from the Cable company or an electronics supply store). Follow the connections shown below. With the switch in the "B" position, you can directly tune any unscrambled channels on your unit. With the switch in the "A" position, tune your unit to the output of the Converter/Descrambler box (usually channel 3 or 4) and use the Converter/Descrambler box to tune scrambled channels.

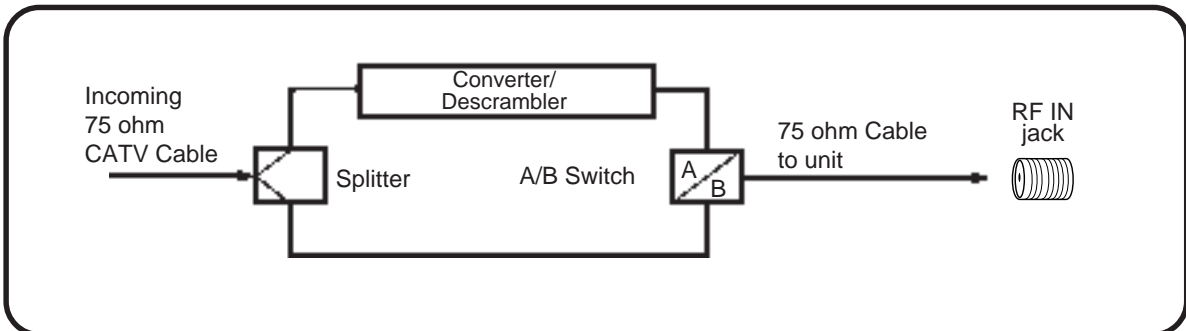

IMPORTANT: Go to page 22 to choose the signal and search for channels.

Connections to other equipment

The exact arrangement you use to interconnect various video and audio components to the unit is dependent on the model and features of each component. Check the Owner's Manual provided with each component for the location of video and audio inputs and outputs.

Using an Audio Amplifier

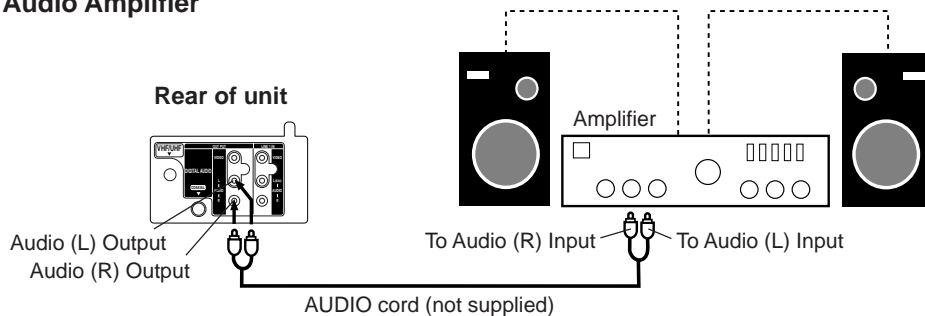

Using an AV Amplifier with built-in digital surround

If you are using an Amplifier with a built-in digital surround as follows, you can enjoy the various audio systems including Dolby Digital Surround audio that sounds just like the movie.

Connect an AV amplifier with built-in Dolby Digital decoder, DTS decoder, MPEG decoder or etc as shown below.

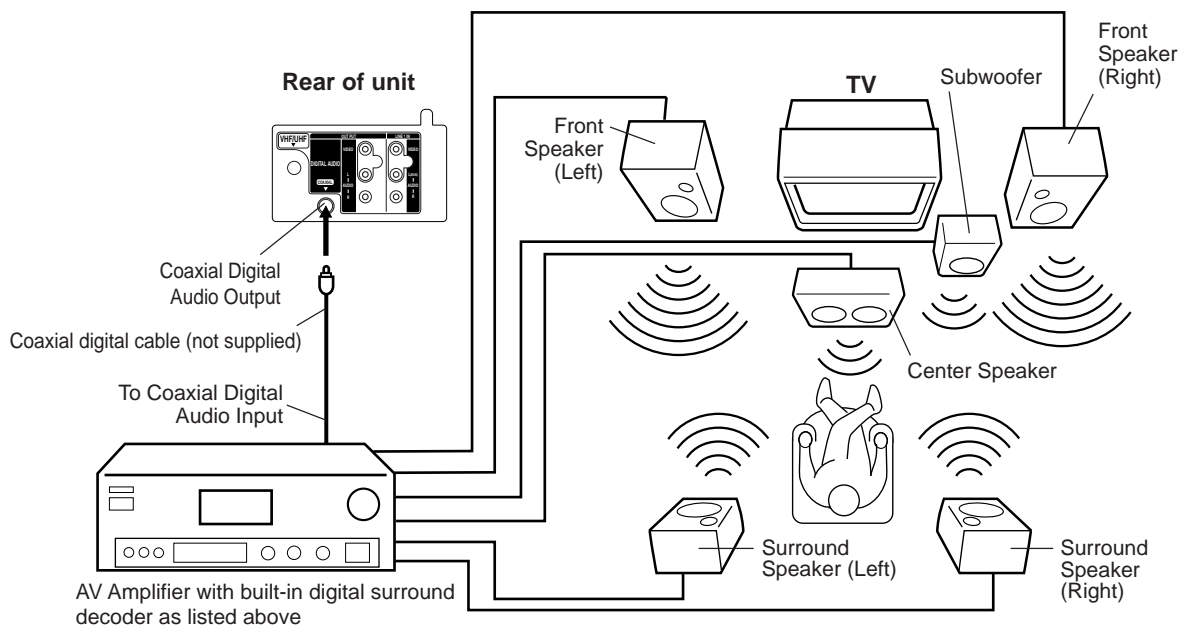

* Manufactured under license from Dolby Laboratories. "Dolby" and the double-D symbol are trademarks of Dolby Laboratories. Confidential unpublished works. © 1992-1997 Dolby Laboratories, Inc. All rights reserved.

* "DTS" and "DTS Digital Out" are trademarks of Digital Theater Systems, Inc.

NOTES:

- When you make the connections above, do not set DOLBY DIGITAL to DOLBY DIGITAL, MPEG to MPEG to ON on the AV Amplifier. If you do, a loud noise will suddenly come out from the speakers, affecting your ears or causing the speakers to be damaged.
- Some DTS decoders which do not support DVD-DTS interface may not work properly with the unit.

Using the audio/video inputs

If you connect the unit to camcorder or a TV game, you can select by pressing **INPUT SELECT**.

Press **INPUT SELECT** repeatedly to select the desired mode.

"LINE1", "LINE2" or TV channel will display on the screen for 4 seconds.

NOTE:

In the DVD mode this key will not operate.

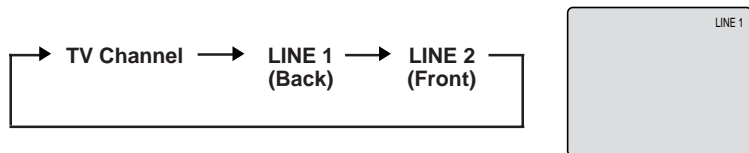

To connect the unit to a camcorder

To playback from the camcorder, connect the camcorder to the unit as shown.

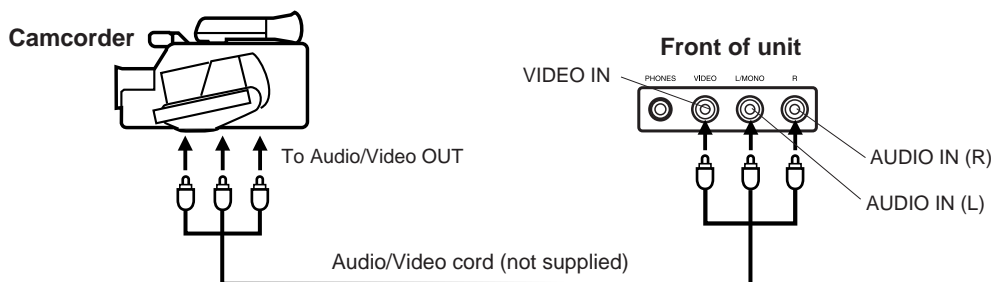

To connect the unit to a Video Game Console

The unit can also be used as a display device for many video games. However, due to the wide variety of formats, they have not all been included in the suggested connection diagram. You'll need to consult each component's Owner's Manual for additional information.

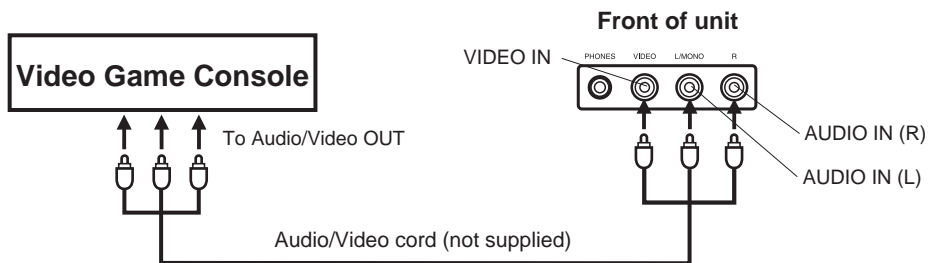

Setting the language

You can choose from three different languages (English, French and Spanish) for the on-screen displays.

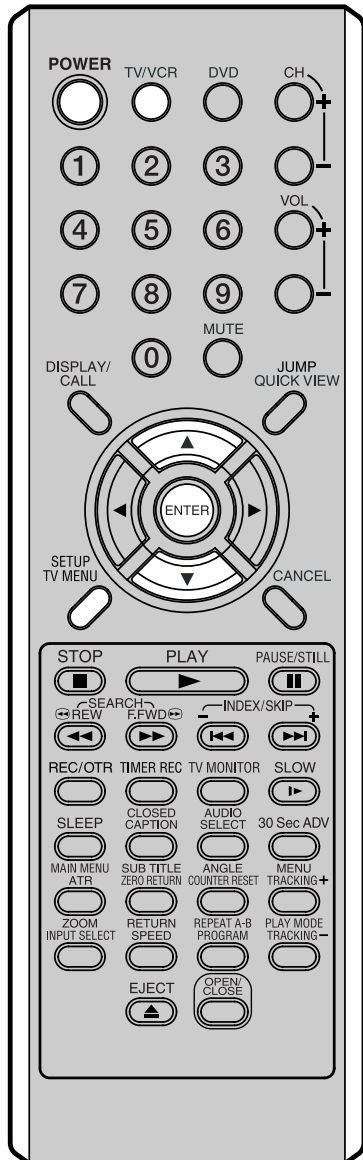

- 1 Press **POWER** to turn on the unit.
- 2 Press **TV/VCR** to select the TV/VCR mode.

- 3 Press **TV MENU**. Press **▲** or **▼** to select "SYSTEM SETUP", then press **ENTER**.
If you use the unit for the first time and press **TV MENU**, instead of the main menu screen on the right the "LANGUAGE" screen in step 5 may appear.

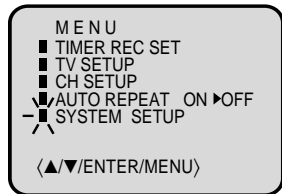

- 4 Press **▲** or **▼** to select "LANGUAGE", then press **ENTER**.

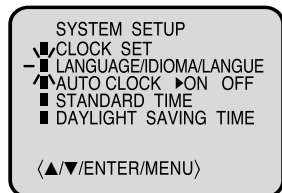

- 5 Press **▲** or **▼** to select the desired language: English (ENGLISH), Spanish (ESPAÑOL) or French (FRANCAIS), then press **ENTER**.



- 6 Press **TV MENU** until the MENU screen is cleared.

NOTES:

- Both the TV/VCR and the DVD have their own menu option (See page 52).
- If no buttons are pressed for more than 60 seconds, the MENU screen will return to normal TV-operation automatically.

Auto clock setting

The Auto Clock function will automatically set the built-in clock (Month, Day, Year and Time) when the unit is connected to an Antenna or Cable system and it is turned off. As the unit searches for a receivable station in your area and it receives a broadcast signal for Auto Clock, the Auto Clock needs several minutes to set itself.

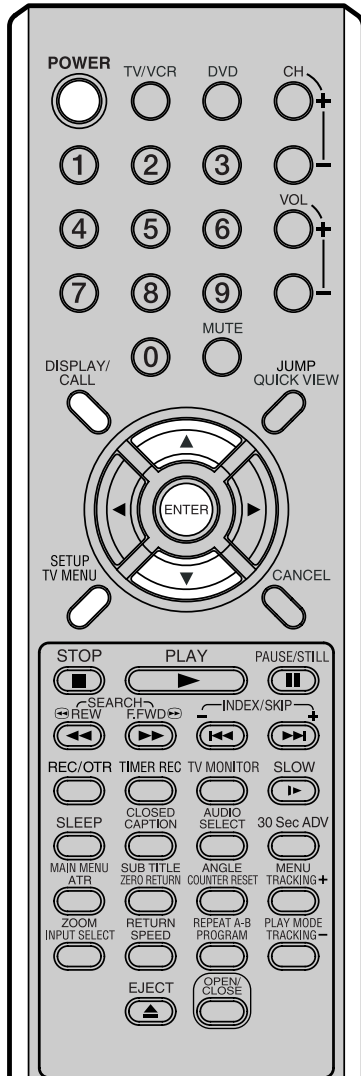

NOTES:

After a power failure or disconnection of the power, the timer settings will be lost. In this case, reset the time.

- If you live in Newfoundland, Canada and the Auto Clock does not function properly, set the AUTO CLOCK menu option to "OFF" and set the clock manually.

AUTO CLOCK SETTING

- 1 Connect the Antenna or Cable system.
 - If you use a cable box, turn it on.
- 2 Plug the AC Power cord to the AC outlet.
- 3 Make sure the TV/VCR/DVD is turned off.
 - If you press **POWER**, Auto Clock set is not effective.
- 4 Wait at least three minutes and press **POWER**.
- 5 Press **DISPLAY/CALL** to check the clock on the screen.
- 6 If the clock is not set, make sure you are receiving TV channels. The Auto Clock may not function properly if the reception condition is not good.

AUTO CLOCK ADJUSTMENT

The Auto Clock Adjustment will be performed at 12:00 PM everyday if you turn off the unit.

- If you use a cable box and you want Auto Clock adjustment to be performed, the cable box must be left on.
- The Auto Clock Adjustment won't work if there is more than 5 minutes between the built-in clock time and the actual time.

TO SET AUTO CLOCK TO OFF

When shipped from factory "AUTO CLOCK" is set to "ON". But if you do not want Auto Clock set (Adjustment):

- 1 Turn on the unit.
- 2 Press **TV MENU**.
- 3 Press **▲** or **▼** to select "SYSTEM SETUP", then press **ENTER**.
- 4 Press **▲** or **▼** to select "AUTO CLOCK".
- 5 Press **ENTER** to select "OFF".
- 6 Press **TV MENU** repeatedly to return to the normal screen.
 - When "AUTO CLOCK" is set to "OFF", the Auto Clock adjustment does not function.
 - Set the clock manually (see page 18).

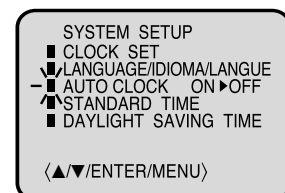
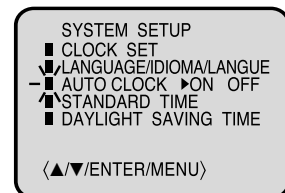
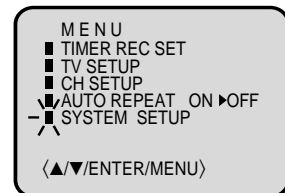

Auto clock setting

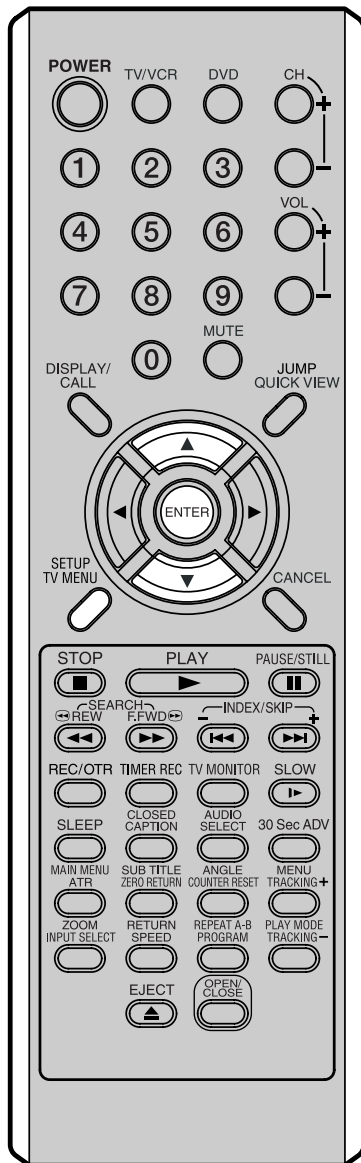

NOTES:

- When shipped from the factory, "DAYLIGHT SAVING TIME" is set to "AUTO".
- When you want to set the Daylight Saving Time manually, on the first Sunday in April you set to "ON", and on the last Sunday in October you set to "OFF".
- When the clock is not set, Daylight Saving Time setting is not available.
- If there is no Daylight Saving Time in your area, always select "OFF" in step 3.

TO SET STANDARD TIME

In the rare event that you live within broadcast range of two stations in two different time zones, the unit may recognize the wrong station for the Auto Clock set.

To correct the situation:

- 1 Press **TV MENU**.
- 2 Press **▲** or **▼** to select "SYSTEM SETUP", then press **ENTER**.
- 3 Press **▲** or **▼** to select "STANDARD TIME", then press **ENTER**.
- 4 Press **▲** or **▼** to select your time zone, then press **ENTER**.

ATLANTIC	:	GMT - 4 hours (GMT: Greenwich Mean Time)
EASTERN	:	GMT - 5 hours
CENTRAL	:	GMT - 6 hours
MOUNTAIN	:	GMT - 7 hours
PACIFIC	:	GMT - 8 hours
ALASKA	:	GMT - 9 hours
HAWAII	:	GMT - 10 hours
AUTO	:	AUTO SET

- 5 Press **TV MENU** repeatedly to return to the normal screen.

NOTE: To be able to select the standard time, the clock must first be set by "AUTO CLOCK" once.

DAYLIGHT SAVING TIME SETTING

You can set the Daylight Saving Time automatically or manually.

- 1 Press **TV MENU**. Press **▲** or **▼** to select "SYSTEM SETUP", then press **ENTER**.

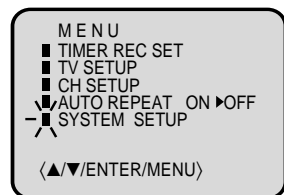

- 2 Press **▲** or **▼** to select "DAYLIGHT SAVING TIME", then press **ENTER**.

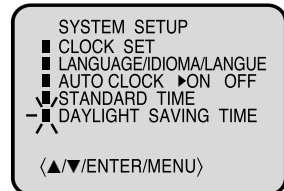

- 3 Press **▲** or **▼** to select one of the options, then press **ENTER**. Press **TV MENU** until the MENU screen is cleared.



- ON:** for manual setting
(forward one hour)
- OFF:** for manual setting
(back one hour)
- AUTO:** for automatic setting
(read XDS in the signal)

Manual clock setting

You must set the date and time manually for Timer Recordings, ON/OFF Timer and Daylight Saving Time if the Auto Clock process did not set them correctly.

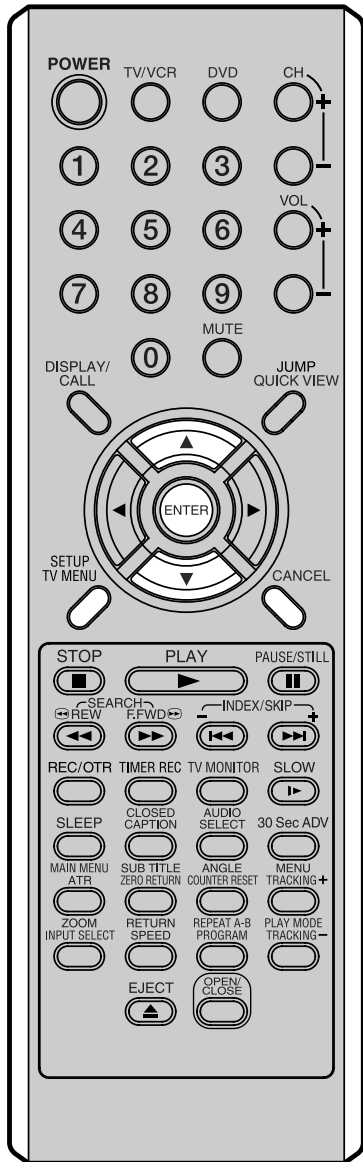

NOTE:

After a power failure or disconnection of the power, the timer settings will be lost. You'll need to reset the time.

EXAMPLE: Setting the clock to "8:30 AM" October, 29 (WED), 2003.

1 Press **TV MENU**. The TV/VCR menu screen will appear.

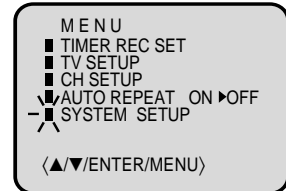

2 Press **▲** or **▼** to select the "SYSTEM SETUP" menu, then press **ENTER**.

3 Press **▲** or **▼** to select the "CLOCK SET" option, then press **ENTER**.



4 Press **▲** or **▼** to set the month, then press **ENTER**.

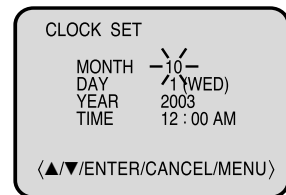

To make corrections any time during the process

Press **CANCEL** repeatedly until the item you want to change blinks, then press **▲** or **▼**.

5 Set the day, year and time as in step 4.

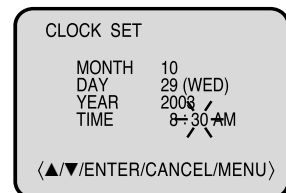

6 After setting the clock, date and time starts functioning automatically.

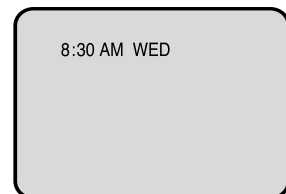

TV operation

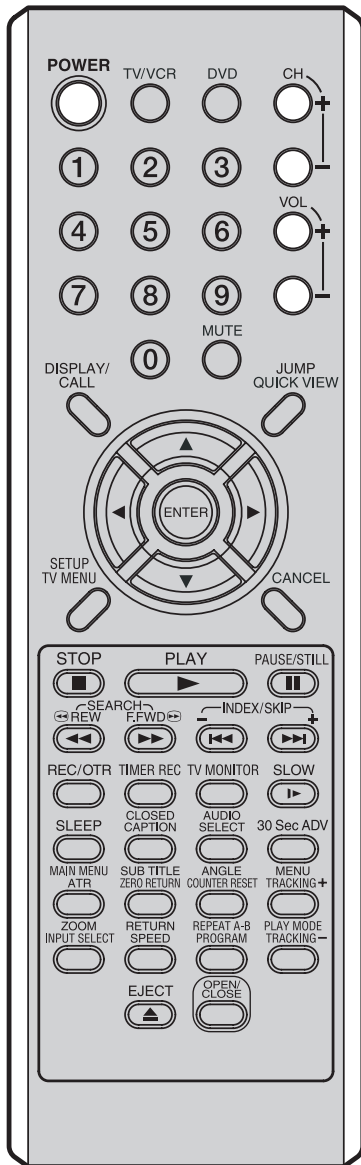

NOTES:

- If a channel with no broadcast is selected, the sound will automatically be muted.
- If a station being viewed stops broadcasting, the TV will automatically shut itself off after 15 minutes.

1 To turn on the unit, press **POWER**.

2 Adjust the volume level by pressing **VOL +** or **-**. The volume level appears.

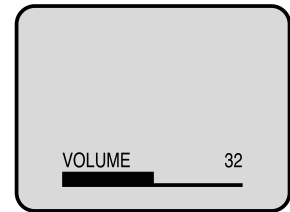

3 Set the TV/CATV menu option to the appropriate position. (See page 22.)

TV - Antenna Connection
CATV - CABLE Connection

4 Press the **number** buttons to select the channel.

Channels can be instantly selected by using two buttons. (for example, to select channel 2, press "0", then "2". If you press only "2", channel selection will be delayed for a few seconds.)

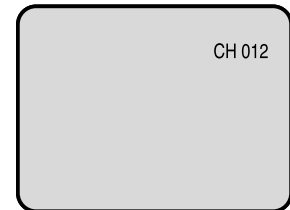

For channels 10 and above, Press the 2 digits in order. For example, to select channel 36, press "36". You can also press "0", then the remaining 2 digits. For example, to select channel 12, press "012".

For 3 digit numbers, press the 3 digits in order. For example, to select channel 120, just press "120".

NOTE:

To view channels above 69 the TV must be set to CATV mode in the **CH SETUP** menu. Go to page 22 for more information.

5 CHANNEL +/-

Press and release **CH +** or **-**. The channel automatically stops at the next channel set into memory. Before selecting channels with the **CH+** and **CH-** buttons, you must put the channels into memory. See pages 22 and 23.

TV	CATV
VHF 2-13	VHF 2-13
UHF 14-69	STD/HRC/IRC 14-36 (A) (W) 37-59 (AA) (WW) 60-85 (AAA) (ZZZ) 86-94 (86) (94) 95-99 (A-5) (A-1) 100-125 (100) (125) 01 (5A)

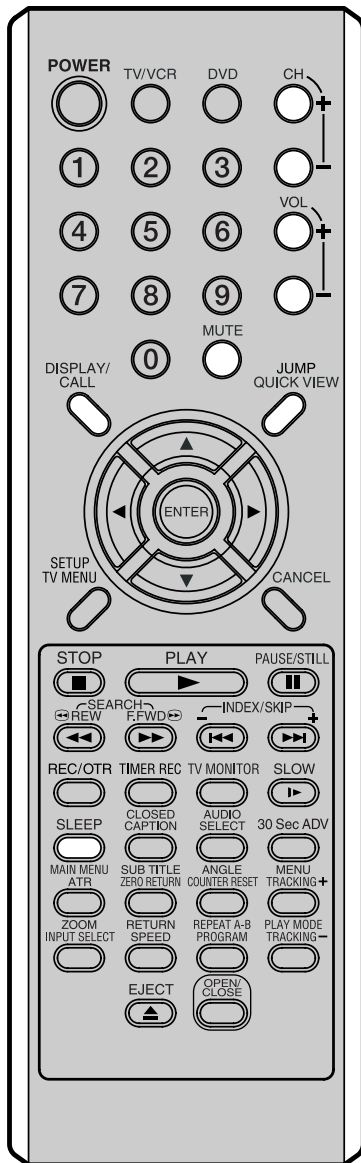

CALL

Press **DISPLAY/CALL** to display the current information on the screen. Press **DISPLAY/CALL** again to clear the call display.

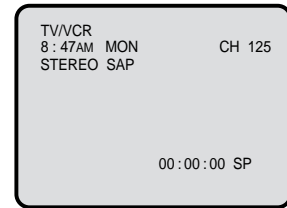

QUICK VIEW

Press **QUICK VIEW** to return to the last channel you were watching.

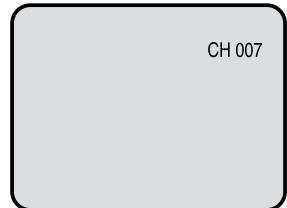

MUTE

Press **MUTE** to switch off the sound. The unit's sound will be silenced and "MUTE" will briefly appear on the screen. The sound can be switched back on by pressing this button again or **VOL +** or **-**.

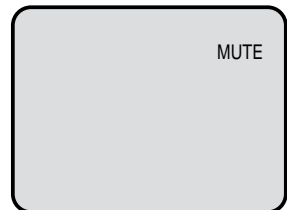

SLEEP

To set the unit to turn off after a preset amount of time, press **SLEEP** on the remote control. The clock will count down 10 minutes for each press of **SLEEP** (120, 110, ...10, 0). After the sleep time is programmed, the display will appear briefly every ten minutes to remind you that the sleep timer is operating. To confirm the sleep timer setting, press **SLEEP** and the remaining time will be displayed for a few seconds. To cancel the sleep timer, press **SLEEP** repeatedly until the display turns to 0.

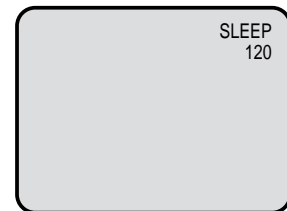

NOTE:

To listen through the headphones, insert a headphones (not supplied) with a 1/8" mini plug into PHONES jack on the front. The sound from the TV speaker is muted.

Closed caption

WHAT IS CLOSED CAPTIONING?

This television has the capability to decode and display Closed Captioned television programs. Closed Captioning will display text on the screen for hearing impaired viewers or it will translate and display text in another language.

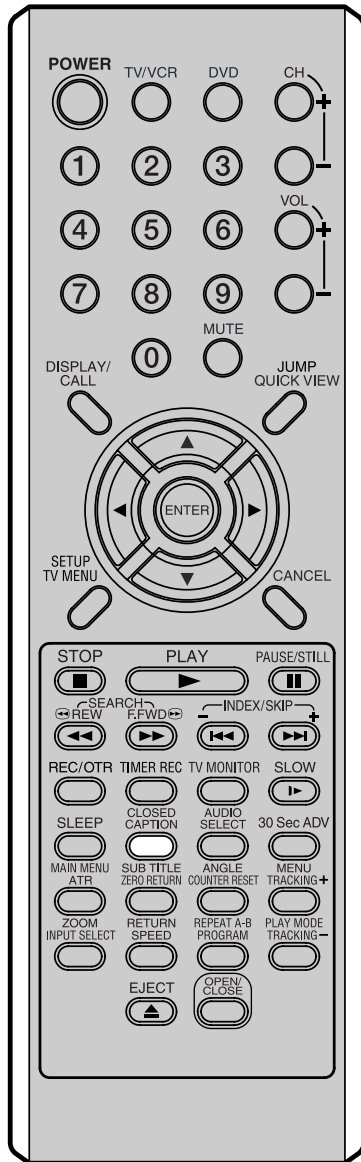

Captions: This Closed Caption Mode will display text on the screen in English or another language (depending on the setting of the Closed Captions CH 1/2).

Generally, Closed Captions in English are transmitted on Captions Channel 1 and Closed Captions in other languages are transmitted on Captions Channel 2.

Text: The Text Closed Caption Mode will usually fill the screen with a programming schedule or other information.

After selecting a Closed Caption Mode, it will stay in effect until it is changed, even if the channel is changed.

If the Captions signal is lost due to a commercial or a break in the signal, the Captions will reappear when the signal is received again. If the channels are changed, the Captions will be delayed approximately 10 seconds. The Captions will appear in places on the screen where they will least interfere with the picture, usually on the bottom of the screen. News programs will usually show three-line Closed Captions which scroll onto the screen.

Most other shows provide two or three lined Captions placed near the character who is speaking so the viewer can follow the dialogue. Words in italics or underlined describe titles, words in foreign languages or words requiring emphasis. Words that are sung usually appear enclosed by musical notes.

For television programs broadcasting with Closed Captions, look in your TV guide for the Closed Captions symbol (CC).

TO VIEW CLOSED CAPTIONS

Press **CLOSED CAPTION** to switch between normal TV and the two closed caption modes (captions and full screen text). Closed captioning will display text on the screen for hearing impaired viewers.

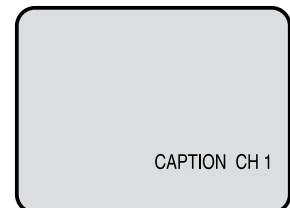

NOTES:

- When selecting Closed Captions, the captioning will be delayed approximately 10 seconds.
- If no caption signal is received, no captions will appear, but the television will remain in the Caption Mode.
- Misspellings or unusual characters may occasionally appear during Closed Captioning. This is normal with Closed Captioning, especially with live programs. This is because during live programs, captions are also entered live. These transmissions do not allow time for editing.
- When Captions are being displayed, on-screen displays, such as volume and mute may not be seen or may interfere with Closed Captions.
- Some cable systems and copy protection systems may interfere with the Closed Captioned signal.
- If using an indoor antenna or if TV reception is very poor, the Closed Caption Decoder may not appear or may appear with strange characters or misspelled words. In this case, adjust the antenna for better reception or use an outdoor antenna.

To memorize channels

This unit is equipped with a channel memory feature which allows channels to skip up or down to the next channel set into memory, skipping over unwanted channels. Before selecting channels, they must be programmed into the unit's memory. In addition to normal VHF and UHF channels, this unit can receive up to 113 Cable TV channels. To use this unit with an antenna, set the TV/CATV menu option to the TV mode. When shipped from the factory, this menu option is in the CATV mode.

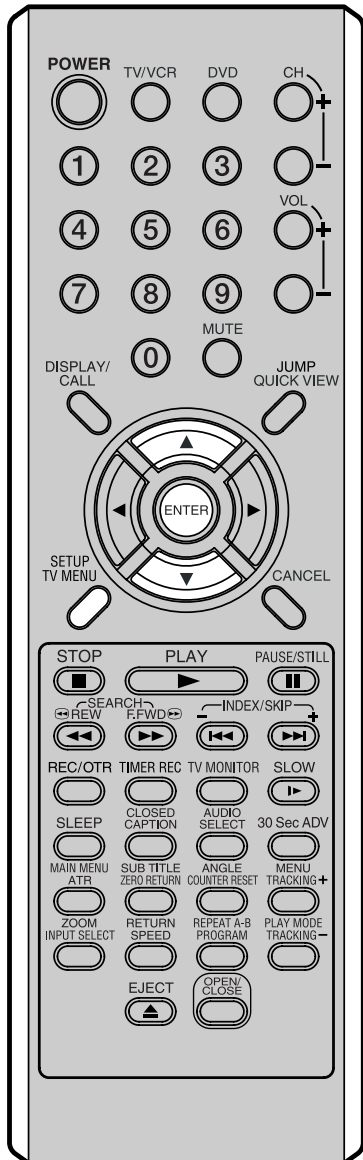

TV/CATV SELECTION

1 Press **TV/VCR**. Press **TV/MENU**, the TV/VCR menu screen will appear.

2 Press **▲** or **▼** to select "CH SETUP", then press **ENTER**.

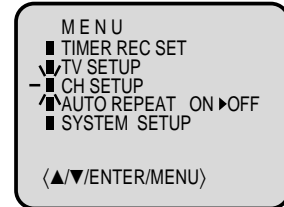

3 Press **▲** or **▼** to select "TV/CATV". If you connected an antenna, select TV. If you have cable service, select CATV.

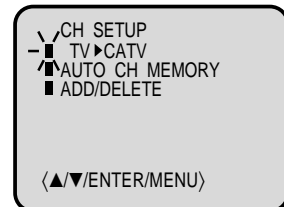

4 Press **ENTER** to select "TV" or "CATV".

TV - VHF/UHF channels
CATV - CABLE TV channels

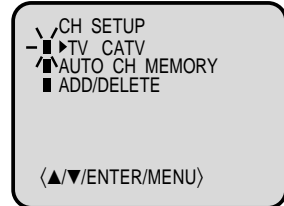

5 Press **SETUP** to remove the **CH SETUP** menu or to stop this operation.

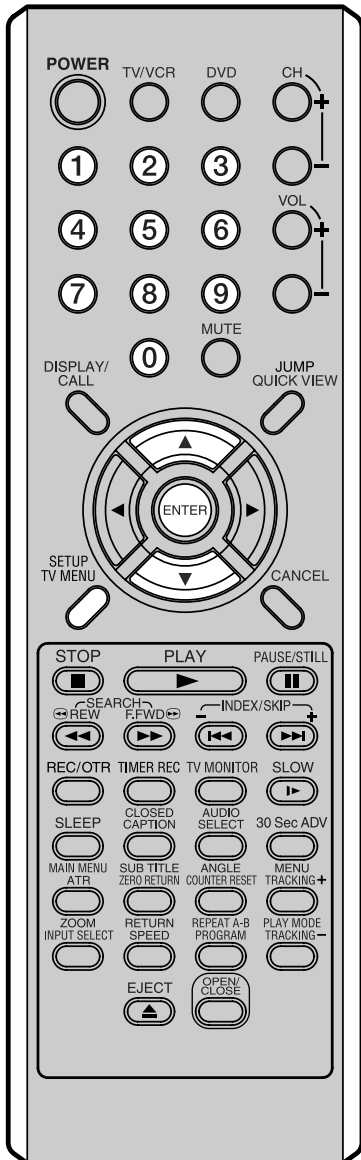

AUTOMATIC MEMORY TUNING

1 Press **TV/VCR**. Press **TV/MENU**, the TV/VCR menu screen will appear.

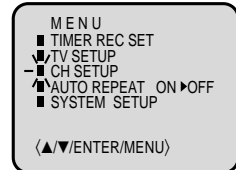

2 Press **▲** or **▼** to select "CH SETUP", then press **ENTER**.

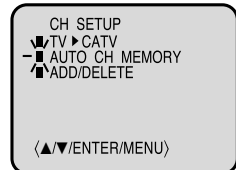

3 Press **▲** or **▼** to select "AUTO CH MEMORY".

4 Press **ENTER**. The TV will begin memorizing all the channels available in your area.

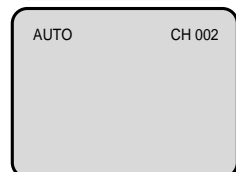

5 Press **TV MENU** until the MENU screen is cleared.

TO ADD/DELETE CHANNELS

1 Press **TV MENU**. The TV/VCR menu screen will appear.

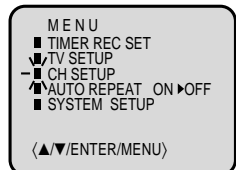

2 Press **▲** or **▼** to select "CH SETUP", then press **ENTER**.

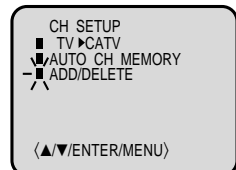

3 Press **▲** or **▼** to select "ADD/DELETE", then press **ENTER**.

4 Select the desired channel to be memorized or deleted using **the number buttons (0-9)**, or **▲** or **▼**.

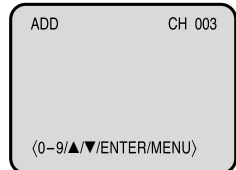

5 Press **ENTER** to select "ADD" or "DEL", whichever function you want to perform.

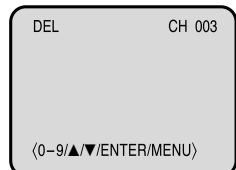

6 Press **SETUP** to remove the **CH SETUP** menu or to stop this operation.

Setting the V-Chip

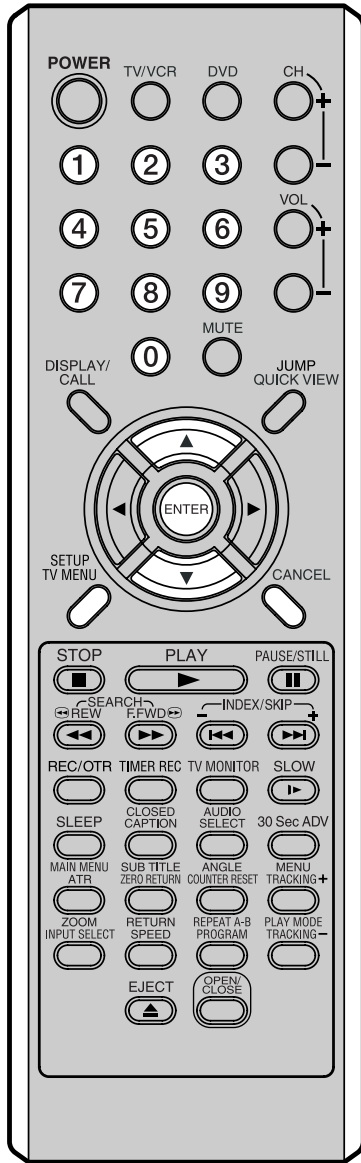

An age limitation can be set to forbid children to see and hear violent scenes or pictures for adults, etc. The unit corresponds to "TV RATING" and "MOVIE RATING". To use the V-Chip function, you must register a password.

TO REGISTER PASSWORD

1 Press **TV/VCR**. Press **TV/MENU**, the TV/VCR menu screen will appear.

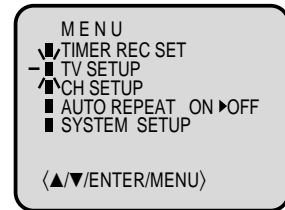

2 Press \blacktriangle or \blacktriangledown to select "TV SETUP", then press **ENTER**.

3 Press \blacktriangle or \blacktriangledown to select "V-CHIP SET", then press **ENTER**.

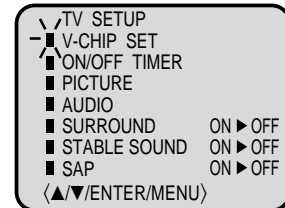

4 Enter a password (4 digits) using the **number buttons (0-9)**, then press **ENTER**.
If you enter an incorrect number, press **CANCEL**.

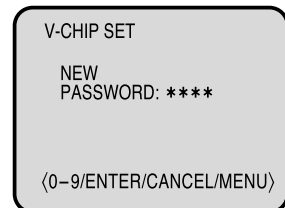

"*" appears instead of the number.

5 Enter the same password again then press **ENTER**.
The password is now registered and V-Chip setting menu appears.

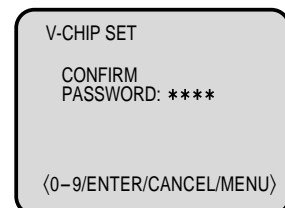

NOTES:

- To avoid forgetting the password, write it down and keep it in a safe place.
- If you forget the password...
 1. Disconnect the AC cord plug from the AC outlet and leave the unit unplugged for more than two minutes.
 2. Insert the AC cord plug again, and turn the volume level to a minimum.
 3. Press the VOL- button on the unit and the 0 button on the remote control for more than 2 seconds simultaneously.

TO SET THE V-CHIP

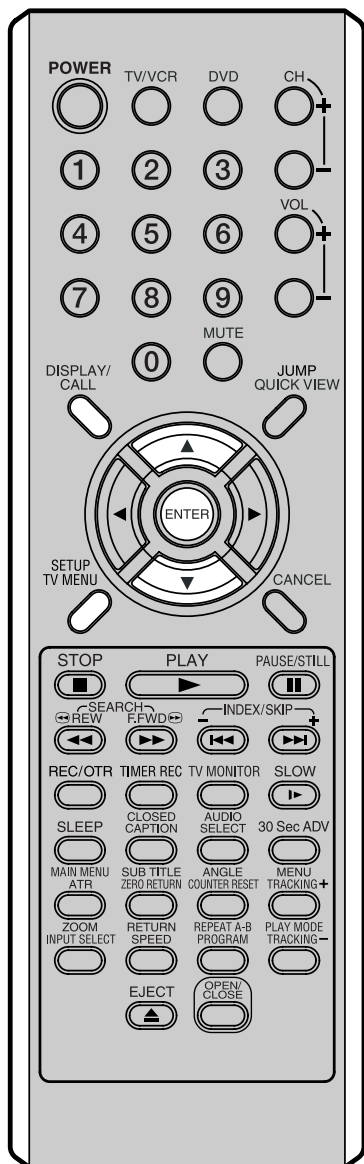

To use the TV after the V-Chip is activated.

When the program applied to the V-Chip setting is received, enter the password, then press **ENTER**. When the password is entered correctly the protection will be temporarily overridden.

NOTE:

The V-Chip function is activated only on programs that support the rating system.

- 1** In the V-CHIP SET menu, press **▲** or **▼** to select "TV RATING", then press **ENTER**.

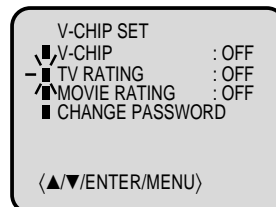

- 2** Press **▲** or **▼** to display the desired setting, then press **ENTER**.

OFF : TV RATING is not set
TV-Y : All children
TV-Y7 : 7 years old and above
TV-G : General Audience
TV-PG : Parental guidance
TV-14 : 14 years old and above
TV-MA : 17 years old and above

When you select TV- Y7, TV-PG, TV-14 or TV-MA, press **DISPLAY/CALL** to show the contained rating. Press **▲/▼** to select the desired item you want. Press **ENTER** to select the setting "ON" or "OFF".

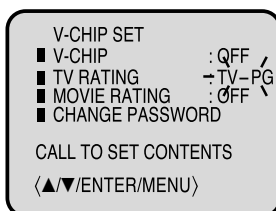

- 3** Press **▲** or **▼** to select "MOVIE RATING", then press **ENTER**.

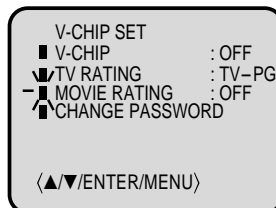

- 4** Press **▲** or **▼** to select desired rating, then press **ENTER**.

OFF : MOVIE RATING is not set
G : All ages
PG : Parental guidance
PG-13 : Parental guidance less than 13 years old
R : Under 17 years old
 Parental guidance suggested
NC-17 : 17 years old and above
X : Adult only

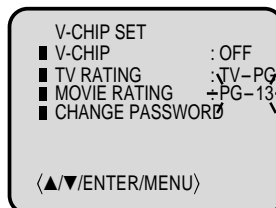

- 5** Press **▲** or **▼** to select "V-CHIP".

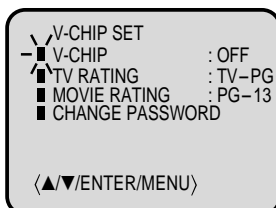

- 6** Press **ENTER** to display "ON". Now your settings were set into the memory.

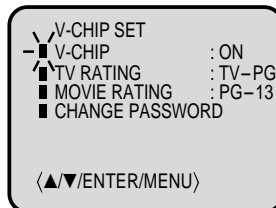

- 7** Press **TV MENU** until the MENU screen is cleared.

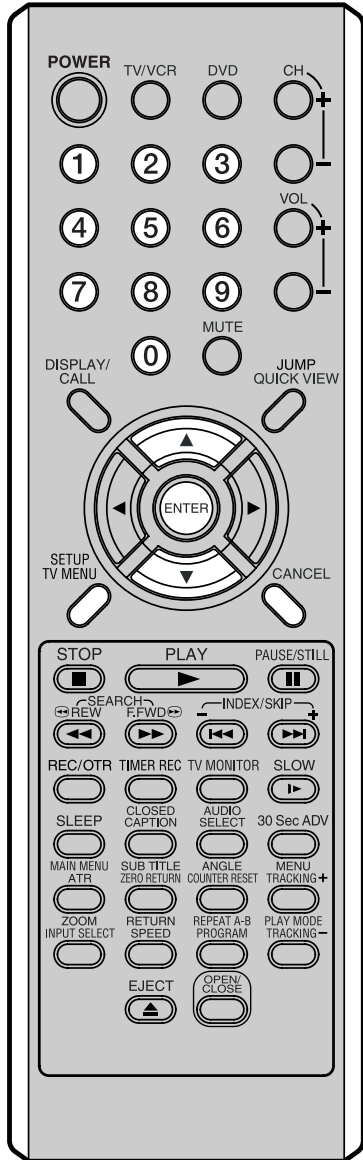

TO CHANGE PASSWORD

1 Press **TV/VCR**. Press **TV/MENU**, the TV/VCR menu screen will appear.

2 Press **▲** or **▼** to select "TV SETUP" then press **ENTER**.

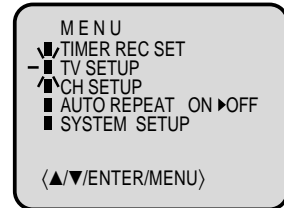

3 Press **▲** or **▼** to select the "V-CHIP SET", then press **ENTER**.

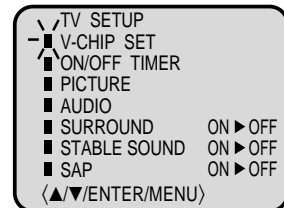

4 Enter your Password using **number buttons (0-9)**, then press **ENTER**.
If you enter an incorrect number, press **CANCEL**.

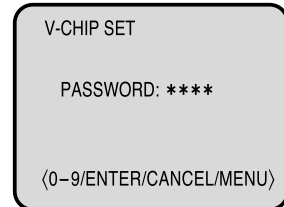

5 Press **▲** or **▼** to select "CHANGE PASSWORD", then press **ENTER**.

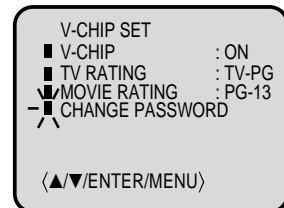

6 Enter a new password using **number buttons (0-9)**, then press **ENTER**.

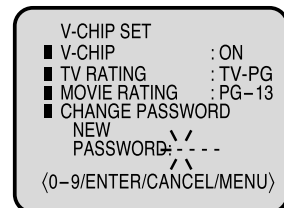

7 Enter the same password again to confirm, then press **ENTER**.

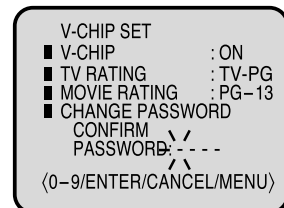

8 Press **TV MENU** repeatedly to return to normal screen.

To set the on timer

This feature allows you to have the unit automatically turn on at a pre-determined time. If you program the **ON TIMER** once, the unit will turn on on the programmed day (daily/weekly) at the same time to the same channel.

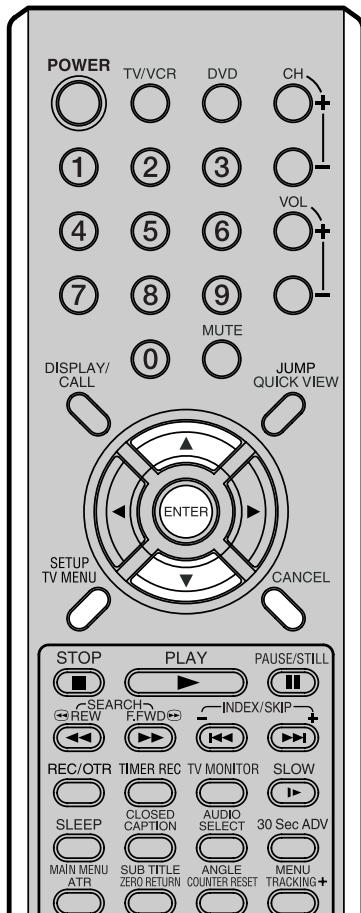

NOTES:

- The unit will automatically turn off approximately 1 hour later after the ON TIMER turns on if no OFF TIMER has been set. To continue watching the TV, press any button to cancel the one hour automatic shut off.
- To cancel ON TIMER, follow above steps 1-5, then press ▲ or ▼ to select "CANCEL". Press **TV MENU** repeatedly to return to the normal screen.
- After setting the ON TIMER, "■" of the OFF TIMER will flash on and off. If you wish to set the OFF TIMER, press **ENTER** then follow the steps 4-6 on page 28 "To set the off timer".
- If you want to correct the digits while setting, press **CANCEL** until the item you want to correct, then press ▲ or ▼ to correct the desired setting.

EXAMPLE: Turning on the TV to channel 12 at 7:00 AM, MON-DAY-FRIDAY.

1 Press **TV MENU**. Press ▲ or ▼ to select "TV SETUP", then press **ENTER**.

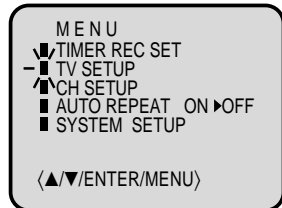

2 Press ▲ or ▼ to select "ON/OFF TIMER", then press **ENTER**.



3 Press ▲ or ▼ to select "ON TIMER", then press **ENTER**.

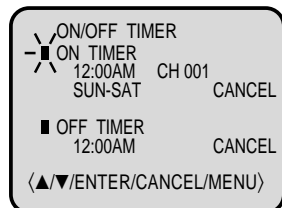

4 Press ▲ or ▼ to set the desired hour, then press **ENTER**.

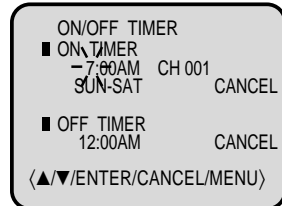

5 Set the desired minute, channel and daily or weekly timer date as in step 4.

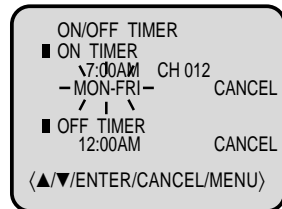

6 Press ▲ or ▼ to select "SET", then press **ENTER**. Press **TV MENU** repeatedly to return to normal screen.

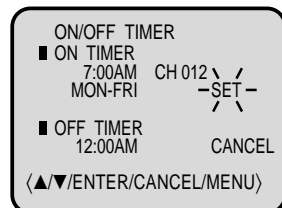

To set the off timer

This feature allows you to have the unit turn off automatically at a predetermined time. If you program the OFF TIMER once, the unit will automatically turn off at the same time everyday.

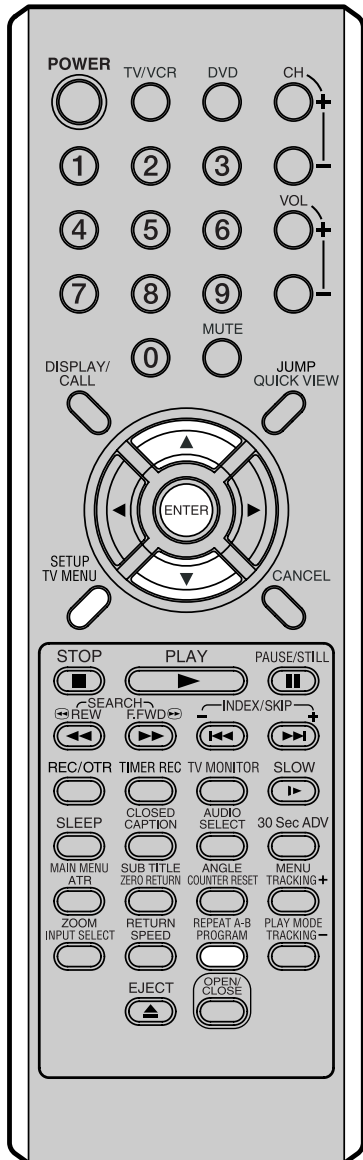

NOTES:

- If a station being viewed stops broadcasting, the TV will automatically shut itself off after 15 minutes.
- To cancel OFF TIMER, follow above steps 1-5, then press ▲ or ▼ to select "CANCEL". Press TV MENU to return to the normal screen.
- To confirm the ON/OFF TIMER: Press PROGRAM twice to indicate the programs on the screen.

EXAMPLE: Turning off the TV at 11:30 PM.

1 Press TV MENU. Press ▲ or ▼ to select "TV SETUP", then press ENTER.

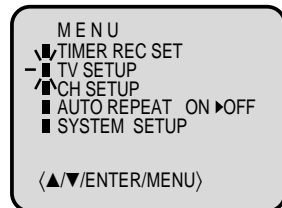

2 Press ▲ or ▼ to select "ON/OFF TIMER", then press ENTER.



3 Press ▲ or ▼ to select "OFF TIMER", then press ENTER.

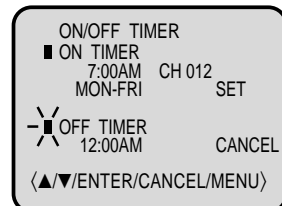

4 Press ▲ or ▼ to set the desired hour, then press ENTER.

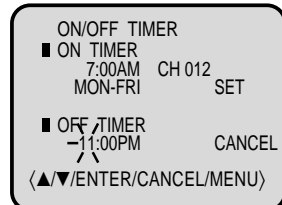

5 Press ▲ or ▼ to set the desired minute, then press ENTER.

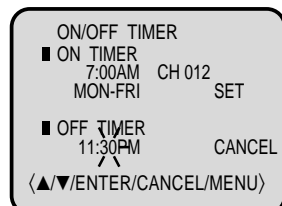

6 Press ▲ or ▼ to select "SET", then press TV MENU repeatedly to return to the normal screen.

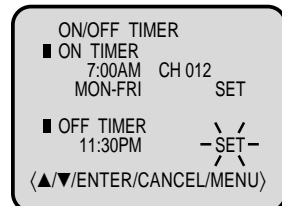

Picture control adjustment

Picture controls are factory preset but you can adjust them individually.

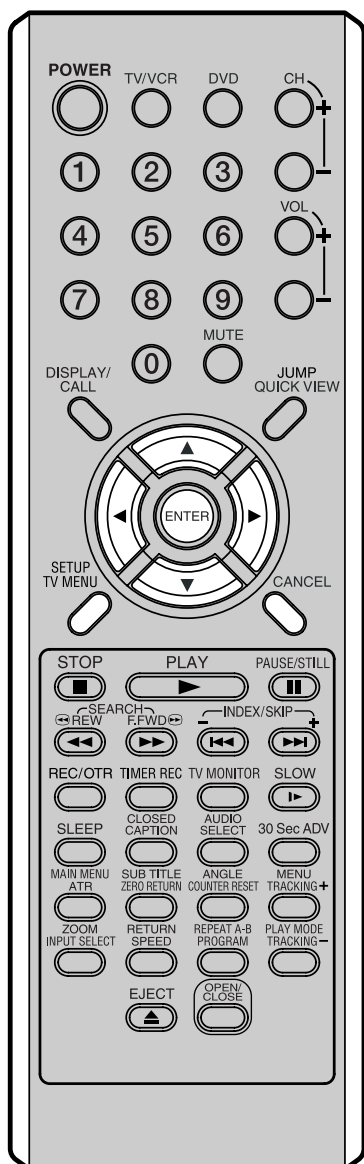

1 Press **TV/VCR**. Press **TV/MENU**, the TV/VCR menu screen will appear.

2 Press **▲** or **▼** to select "TV SETUP", then press **ENTER**.

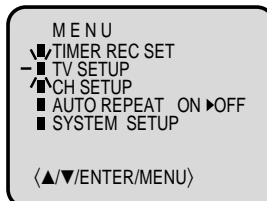

3 Press **▲** or **▼** to select "PICTURE", then press **ENTER**.

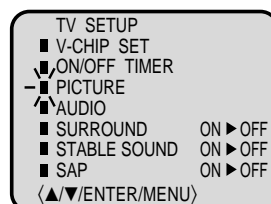

4 Press **ENTER** to select the item you want to adjust. Press **◀** or **▶** to adjust the setting.

	▶	◀
BRIGHTNESS	increase brightness	decrease brightness
CONTRAST	increase contrast	decrease contrast
COLOR	brilliant color	pale color
TINT	greenish color	reddish color
SHARPNESS	makes picture clearer	makes picture softer

5 After your desired setting press **TV MENU** until the MENU screen is cleared.

CANCEL

To return all setting to the factory levels, press **CANCEL** while you're in the Picture menu.

NOTES:

- The **CONTRAST** default setting is set to maximum at the factory.
- The On-screen display will disappear 6 seconds after finishing an adjustment or by pressing **TV MENU** three times. The setting can only be adjusted when they are displayed on the TV screen.

Sound control adjustment

Sound controls are factory preset but you can adjust them individually.

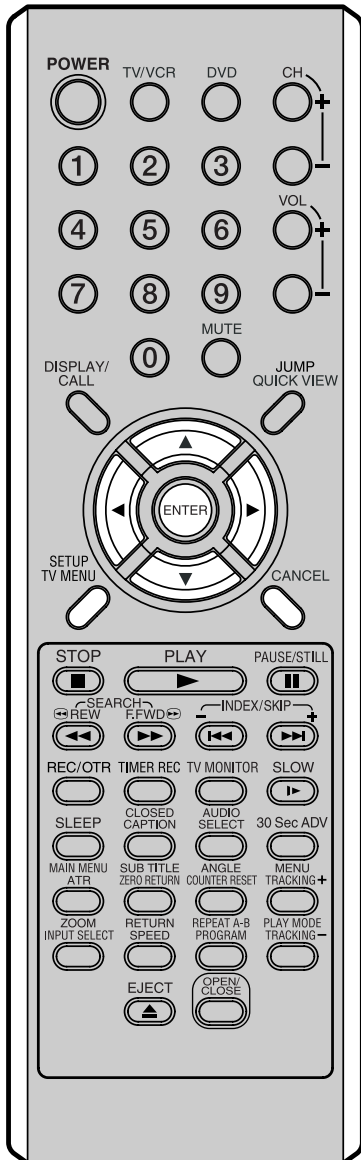

1 Press **TV/VCR**. Press **TV/MENU**, the TV/VCR menu screen will appear.

2 Press **▲** or **▼** to select "TV SETUP", then press **ENTER**.

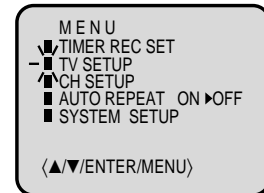

3 Press **▲** or **▼** to select "AUDIO", then press **ENTER**.

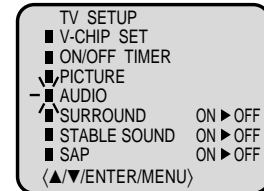

4 Press **ENTER** to select the item you want to adjust. Press **◀** or **▶** to adjust the setting.

BASS:

Press **◀** or **▶** to adjust the bass sound.

TREBLE:

Press **◀** or **▶** to adjust the treble sound.

BALANCE:

Press **◀** or **▶** to obtain an equal sound level from both speakers.

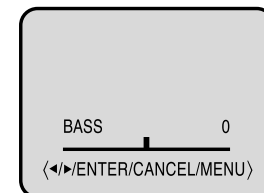

5 After your desired setting press **TV MENU** until the MENU screen is cleared.

CANCEL

Pressing **CANCEL** while making sound adjustments will return all adjustments to the factory preset levels.

NOTE:

- The On-screen display will disappear 6 seconds after finishing an adjustment or by pressing **TV MENU** three times. The setting can only be adjusted when they are displayed on the TV screen.

Loading and Unloading a cassette tape

Use only video cassette tapes marked **VHS**.

Loading

Push the center of the tape until it is automatically inserted.



Insert the cassette tape with its labeled side facing up and the erase prevention tab positioned at your left. An inverted cassette tape cannot be inserted.

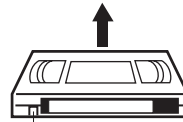

Erase prevention tab

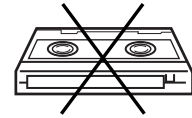

Automatic power ON

When you insert a cassette tape the unit power will turn ON automatically.

Automatic playback

When you insert a cassette tape without an erase prevention tab, playback will start automatically.

Unloading

1 Press **EJECT** on the unit or the Remote.

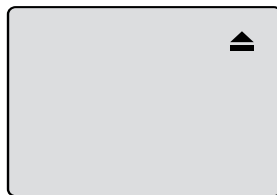

2 Remove the cassette tape.

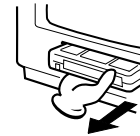

Automatic tape eject

This unit will automatically rewind the tape when the tape has ended. When the tape is rewound to the beginning, it will eject automatically.

To prevent accidental erasure

Remove the erase prevention tab with a screwdriver.

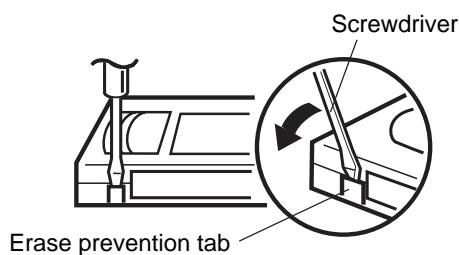

To record again

Cover the hole with a piece of adhesive tape.

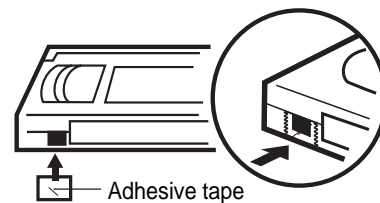

Tape speed and maximum recording time

Tape Speed	Video cassette tape				
	T-160	T-120	T-90	T-60	T-30
SP (Standard Play)	2-2/3 hours	2 hours	1-1/2 hours	1 hour	30 minutes
SLP (Super Long Play)	8 hours	6 hours	4-1/2 hours	3 hours	1-1/2 hours

Cassette tape playback

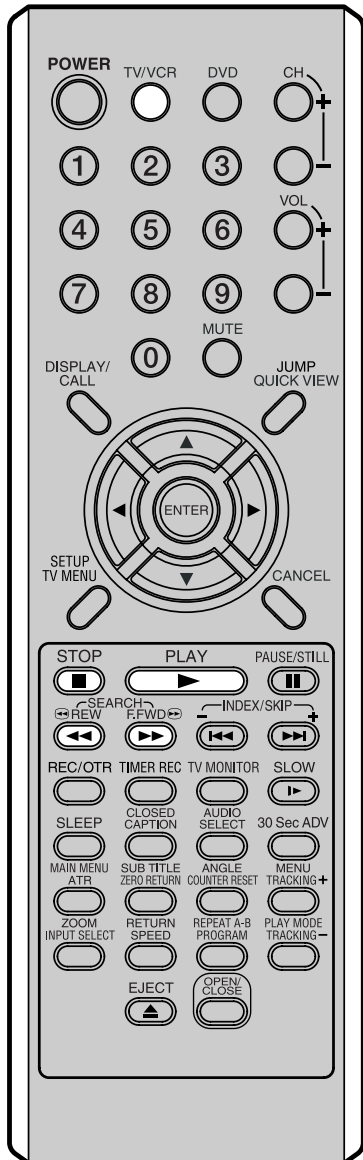

Preparation:

- Press **TV/VCR** to select the TV/VCR mode.

- 1 Insert a prerecorded tape (When loading a cassette tape without the erase prevention tab, playback will start automatically).

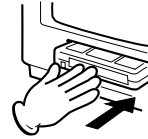

- 2 If the tape doesn't start playing automatically.

Press **PLAY**.

Playback will start.

"▶" will appear on the screen temporarily.



To stop playback

Press **STOP** once.

The tape will stop but remain fully loaded and ready to play.

"■" will appear on the screen temporarily.



To rewind the tape or forward it rapidly

Stop the playback or recording by pressing **STOP**.

To rewind the tape:

Press **REW**.



To forward the tape:

Press **F.FWD**.



To stop the tape-winding, press **STOP**. To switch to playback directly (without **STOP**), press **PLAY**.

Forward/Reverse picture search mode

When the tape is being winded, you can switch to picture search mode (see next page). To do this, press **REW** or **F.FWD** and hold it down. The unit will resume the tape winding as soon as the button is released.

NOTES:

- This unit selects the playback tape speed SP, LP or SLP automatically.
- If you play a prerecorded tape after the DVD playback, you must set the unit to TV/VCR mode using **TV/VCR**.
- When you select the TV/VCR mode during DVD playback, DVD playback will change to the still mode, and after 5 minutes it will change to the stop mode automatically.

Special playback

Picture Search

Reverse picture search function

Press **REW** x 1 or x 2 during the playback.

Forward picture search function

Press **F.FWD** x 1 or x 2 during the playback.

To return to playback: Press **PLAY**.

SPEED SEARCH TIMES

TAPE SPEED	PICTURE SEARCH SPEED	
	PRESS ONCE	PRESS TWICE
SP (Standard Play)	3 X	5 X
LP (Long Play)	7 X	9 X
SLP (Super Long Play)	9 X	15 X

Still Picture

Press **PAUSE/STILL** during playback. To resume normal playback: Press **PLAY**.

Slow Motion

During playback press **SLOW**.

To return to playback: Press **PLAY** or **SLOW**.

Slow tracking and vertical lock adjustment

If noise bars appear in the picture during slow motion, press the **TRACKING +** or **-** to reduce the noise bars. If the still picture jitters excessively, press **TRACKING +** or **-** to stabilize the still picture.

Frame by Frame picture

Press **PAUSE/STILL** during playback.

Press **SLOW** repeatedly. The picture advances frame by frame.

To return to playback: Press **PLAY** or **PAUSE/STILL**.

Adjusting tracking condition

Automatic tracking adjustment

Whenever you insert a tape and start playback, automatic tracking starts working and continuously analyzes the signal to enable optimum picture quality during playback.

Manual tracking adjustment

If automatic tracking cannot eliminate noises well during playback, press **TRACKING +/-** to eliminate the noises. "MANUAL TR." will appear. Press it briefly for a fine adjustment, or press and hold for a coarse adjustment.

- Press **ATR** to reactivate automatic tracking again. "AUTO TR." will appear.

NOTES:

- The audio output is muted during SPEED SEARCH, STILL, FRAME ADVANCE and SLOW MOTION.
- During picture search mode there will be noise bars which are caused by the system.
- If the tape is paused during playback for more than approximately 5 minutes the pause function will automatically release the tape back to play mode to protect the video tape against excessive wear.

Repeat playback

The entire video tape will be played until its end. The tape will then automatically rewind to the beginning and the playback will be repeated.

1 Press **TV MENU**. Press **▲** or **▼** to select "AUTO REPEAT".

2 Then press **ENTER** to select "ON" or "OFF". If "ON" is selected, the playback will be repeated endlessly.

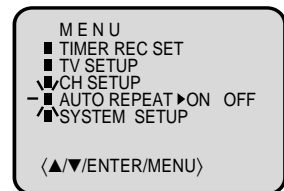

3 Press **TV MENU** until the menu screen is cleared. If you press **DISPLAY/CALL**, "⏪" will appear on the screen.

4 To start the playback, press **PLAY**. The playback will be repeated endlessly.

To cancel repeat mode:

Follow the above step 1, then press **ENTER** to select the OFF position. Press **TV MENU** to return to the TV.

To monitor a TV program

Press **TV MONITOR** while in the playback mode. The video tape will continue to play while the picture switches to the TV channel selected on the unit. Press the button to return to the playback picture.

Advancing

Press **30 Sec ADV** in the PLAY mode. The unit will search forward through approximately 30 seconds of the tape each time you press **30 Sec ADV** (maximum six presses) and then resume normal playback.

For example: 1 press: 30 second of tape
2 press: 60 second of tape
3 press: 90 second of tape

ZERO RETURN function / Video index search system

ZERO RETURN function

This function makes tape-rewinding stop at the counter 00:00:00 position automatically.

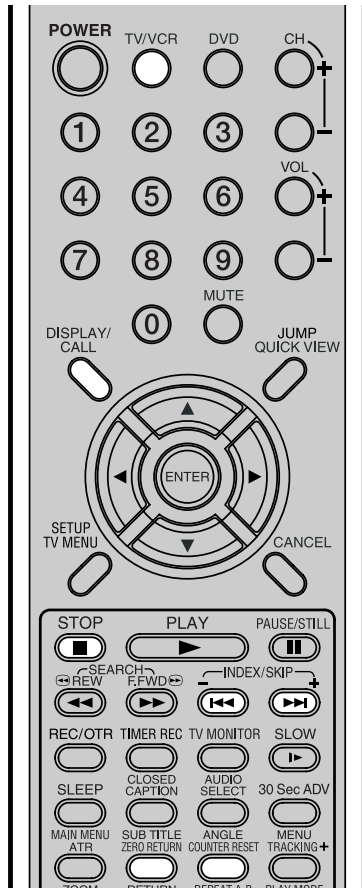

NOTES for Counter Display:

- If you rewind the tape beyond "00:00:00", a minus sign ("-") will be displayed in front of the time.
- When you load a tape, the counter will reset to "00:00:00".
- The counter does not function on nonrecorded (blank) sections of the tape. When you rewind, fast forward or play tapes through blank sections, the counter stops.

NOTES for Video index search system:

- When you record an INDEX mark at the very beginning of the tape, the mark may not be found.
- During INDEX search, the tape may stop and begin to play at a slightly different location.
- INDEX may not function properly with old or worn out video tapes.
- INDEX marks may not be found if it is extremely close to the point where the search began.
- In recording, if you stop recording temporarily, the INDEX mark is not recorded on the tape.

Preparation:

- Press TV/VCR to select the TV/VCR mode.

1 Press **DISPLAY/CALL**.
The counter display shows the tape running time during playback or recording.

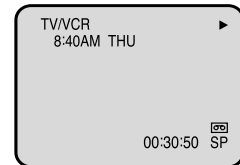

2 Press **COUNTER RESET** at the desired tape position. The counter display will be reset to the "00:00:00" position (e.g. the beginning of recording).

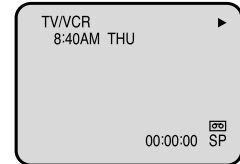

3 Press **STOP** when playback or recording is finished. Press **ZERO RETURN**.
The tape will rewind or fast forward and automatically stop at the "00:00:00" position.

Video index search system

This function enables you to locate the beginning of any recording made on the VCR.

Recording an INDEX MARK

The Index Search function automatically records an INDEX mark on the tape whenever a recording is initiated.

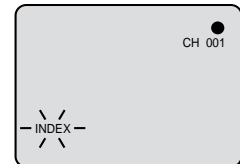

Index Search

Press **INDEX +** or **-** during stop or play mode.

For Succeeding programs: Press **INDEX +**.

For Preceding programs: Press **INDEX -**.
(Additional press increases the INDEX NO. up to 9.)

When the **INDEX +** or **-** is pressed, the unit starts searching the INDEX NO. selected and finds the portion, then playback starts automatically.

To stop the Index Search, press **STOP**.



9 or 8 is displayed
INDEX NO. (up to 9)

Recording a TV program

Recording and viewing the same TV program

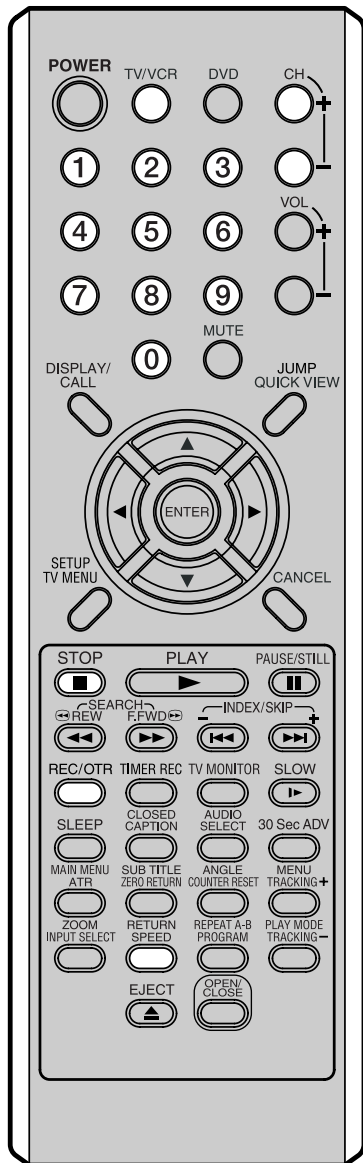

NOTES:

- If power is switched off during recording, the TV and the DVD turn off and the VCR continues to record. Press **STOP** to halt the recording and turn off the VCR.
- The unit channel cannot be changed during recording.
- If you record the TV program after playing a DVD, you must set the unit to TV/VCR mode by pressing **TV/VCR**.
- You cannot record disc material in DVD, Audio CD, etc. onto a video tape with this unit.

Preparation:

- Press **TV/VCR** to select the TV/VCR mode.

- 1 Load a cassette tape with the erase prevention tab intact. The unit will automatically turn on.



- 2 Press **SPEED** to select the desired tape speed SP or SLP. The tape counter and SP or SLP will appear on the screen temporarily.

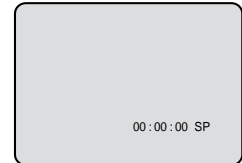

- 3 Make sure the TV/CATV option is set to the appropriate position (See page 22).

TV - VHF/UHF channels
CATV - CABLE TV channels

- 4 Press the **number buttons (0-9)** or **CH +/-** to select the channel to be recorded.

- 1-9 Press **0** twice and then **1-9** as required. Example: To select 2, Press **"002"**.
- 10-12 Press **0** first and then the remaining 2 digits in order from left to right. Example: Press **012** for "12".
- 13-99 Press 2 digits in order. Example: Press **22** for "22".
- 100-125 Press the 3 digits in order. Example: Press **110** for "110".

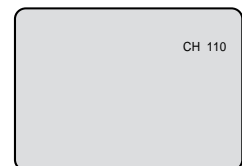

VHF/UHF/CATV CHANNELS

TV	CATV
VHF 2-13	VHF 2-13
UHF 14-69	STD/HRC/IRC 14-36 (A) (W) 37-59 (AA) (WW) 60-85 (AAA) (ZZZ) 86-94 (86) (94) 95-99 (A-5) (A-1) 100-125 (100)(125) 01 (5A)

- 5 Press **REC/OTR**. "●" will appear on the screen temporarily and the REC/OTR indicator will light.

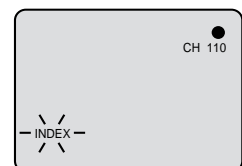

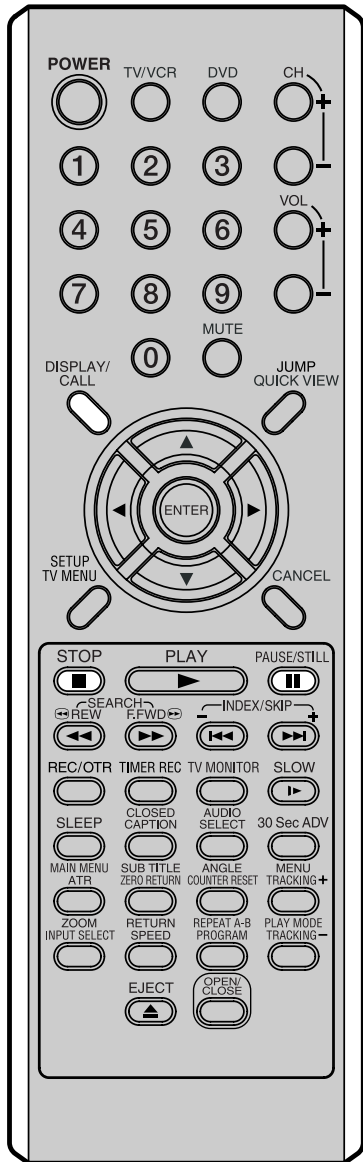

To stop recording

Press **STOP** to stop recording. "■" will appear on screen for about 4 seconds.



To stop recording temporarily

Press **PAUSE/STILL** to avoid recording unwanted material. Press again to continue the recording. "||" will appear on screen temporarily.



NOTES:

- The pause function will be released after 5 minutes to prevent damage to the tape or the unit. The unit will change to the STOP mode.
- You can select a recording channel in the recording pause mode.

To Display VCR operation Status

Press **DISPLAY/CALL**. The clock, day of the week and other information will appear.

While watching TV

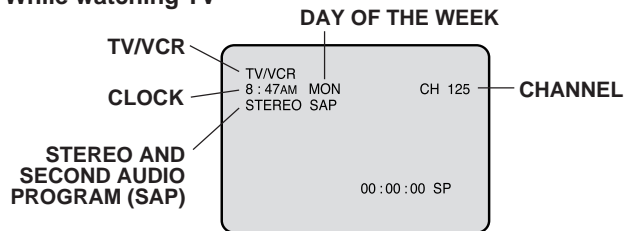

While operating a tape

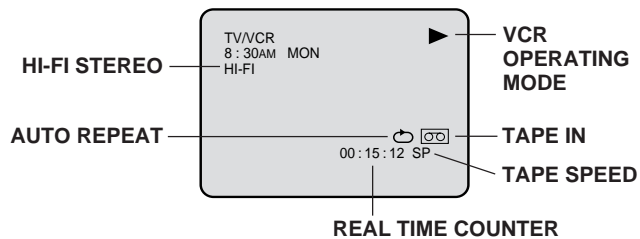

To cancel the display: Press **DISPLAY/CALL** until all indicators disappear.

Auto Rewind feature

This VCR will automatically rewind the tape when the tape has ended (except during OTR and TIMER REC). It will also eject the tape.

One-touch Timer Recording (OTR)

The One-touch Timer Recording feature provides a simple and convenient way to make a timed recording.

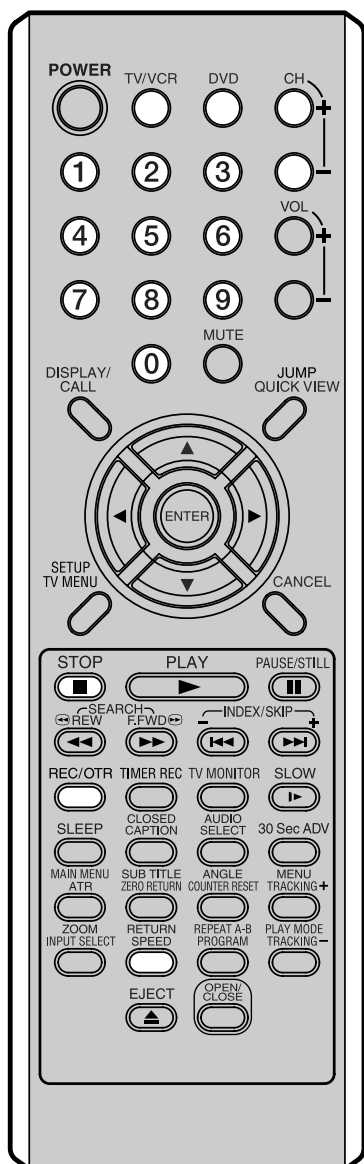

Preparation:

- Press **TV/VCR** to select the TV/VCR mode.

Example: One-touch Timer Recording for 30 minutes.

- 1 Load a cassette tape with the erase prevention tab intact. The unit will automatically turn on.

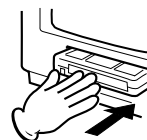

- 2 Press **SPEED** to select the desired tape speed SP or SLP. The tape counter and SP or SLP will appear on the screen temporarily.

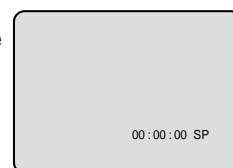

- 3 Set the TV/CATV option to the appropriate position (See page 22).

TV - VHF/UHF channels
CATV - CABLE TV channels

- 4 Press **Direct Channel Selection (0-9)** or **CH +/-** to select the channel to be recorded.

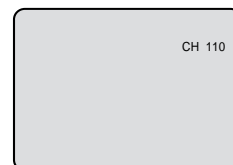

- 5 Press **REC/OTR**. Press the button again to stop recording after 30 minutes. Each additional press of **REC/OTR** will increase recording time as shown in the chart below, up to a maximum of 6 hours. The OTR and recording time will appear on the screen temporarily.

Press	Recording time	Press	Recording time
once	NORMAL REC	6 times	3:00
twice	0:30	7 times	4:00
3 times	1:00	8 times	5:00
4 times	1:30	9 times	6:00
5 times	2:00	10 times	NORMAL REC

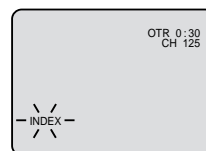

NOTES:

- If you wish to watch the DVD playback during the recording or the OTR, press **DVD** to change to DVD mode and perform the DVD playback.
- The channel cannot be changed during recording.

To cancel OTR

Press **STOP**.

"■" will appear on screen temporarily.



Timer recording

Timer recording can be programmed on-screen with the remote control. The built-in timer allows automatic unattended recording of up to 8 programs within 1 month.

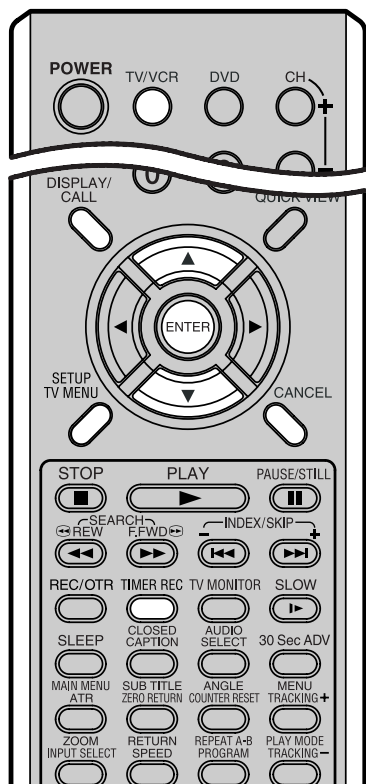

NOTES:

- If the T.REC indicator blinks when the timer recording ended, the TV program has not been completely recorded because of an insufficient tape supply. Press **TIMER REC** to cancel the timer program or press **EJECT** to remove the cassette tape.
- During timer recording standby mode, the VCR operation cannot be used. To use the VCR operation, press **TIMER REC** to deactivate the timer. After you use the VCR, press **TIMER REC** again to put the VCR into timer recording standby mode.
- If you press **TIMER REC** during timer recording, the recording operation will be interrupted. If you press **TIMER REC** again within the programmed time, the recording operation will start again.
- After a power failure or disconnection of the power plug, all programmed recording settings and time display will be lost upon resumption of power. In this case, reset the clock (see pages 16-18) and reprogram any timer recordings.

Preparation:

- Press **TV/VCR** to select the TV/VCR mode.
- Load a cassette tape with the erase prevention tab intact.
- Press **DISPLAY/CALL** to verify that the time and date are correct (see page 36).

Example: Program a timer recording for the 23rd day, channel 125 (CATV), 7:00 - 9:30 PM on timer program number 1 (Tape speed: SLP).

- 1 Press **TV MENU**. Select "TIMER REC SET", then press **ENTER**.

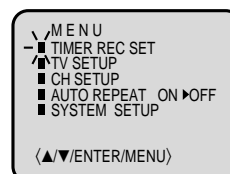

- 2 Press **▲** or **▼** to select one of the program line, then press **ENTER**.

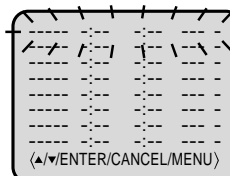

- 3 Press **▲** or **▼** to select the date, then press **ENTER**.

NOTE:

To set up a daily or weekly timer, go to page 39.

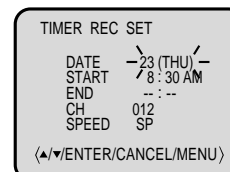

- 4 Set the **start time**, **end time**, **channel** and **tape speed** as in step 3.

NOTES:

- Press **CANCEL** to move cursor backward for correction.
- To record from external source set the channel to "L1" or "L2". "L1" or "L2" will appear next to CH 125 (or 69).

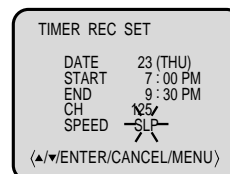

- 5 To enter other programs, repeat step 2 through 4.

- To return to the normal screen, press **TV MENU** twice.

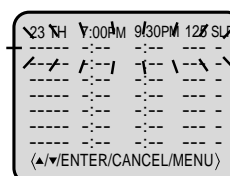

- 6 Press **TIMER REC**. The T.REC indicator will light and the VCR stands by for recording. The timer recording will start at 5 seconds before the time you predetermined.

NOTES:

- If the T.REC indicator does not light in spite of the pressing of **TIMER REC**, the cassette may not have been loaded yet. (see page 31)
- If the cassette is ejected in spite of the pressing of **TIMER REC**, the erase prevention tab of the cassette may have been removed. (see page 31)

Timer recording special case

Weekly (e.g. WKL-TUE: each Tuesday) or daily (e.g. MON-SAT: Monday to Saturday) Timer recording

Follow the procedure of timer recording on the previous page. At picture 3 press ▲ or ▼ repeatedly until the desired setting appears. Then press ENTER.

When you press ▼ repeatedly, the indicator at DATE will change as follows, in this case the day is Friday.

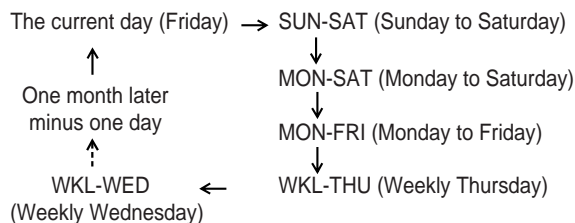

In case Timer programs-overlap

- Do not overlap timer programs as portions of the conflicting programs will be lost. The first recording time has priority over the next recording time as shown in the diagram below.

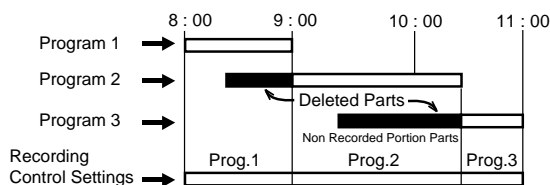

NOTES:

- The daily/weekly recording can be made continuously until the recording is canceled or the tape reaches the end.
- During timer recording the automatic rewinding mechanism does not function.

To confirm the settings

Press PROGRAM once. The TV screen displays the timer program list. Press PROGRAM again. The TV screen displays the ON/OFF TIMER setting.

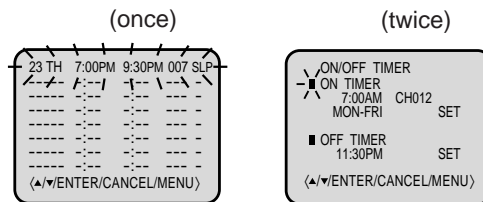

Press PROGRAM 3 times. The screen returns to the normal screen.

To cancel a program

Press ▲ or ▼ to select "TIMER REC SET" in the MENU, then press ENTER. Press ▲ or ▼ to select the unnecessary program, and press CANCEL to cancel the program.

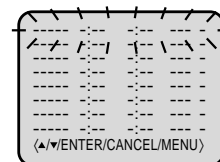

NOTES:

- If there are other timer record programs remaining, **TIMER REC** must be pressed to reactivate the timer, otherwise the remaining timer record programs will be ignored.
- You can correct or cancel a programmed setting in program confirm mode.

Setting the surround sound / Setting the stable sound

Setting the surround sound

The surround sound feature expands the audio listening field wider and deeper to create exceptional sound quality from the TV's speakers.

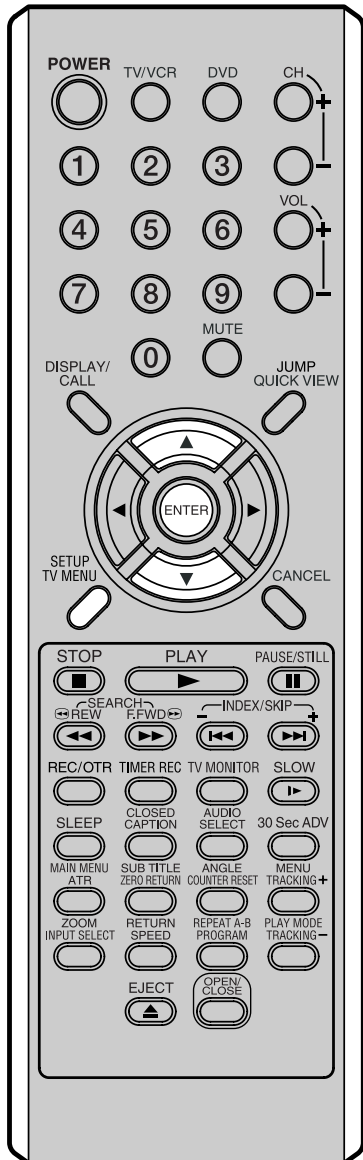

- 1 Press **TV/VCR**. Press **▲** or **▼** to select "TV SETUP", then press **ENTER**.

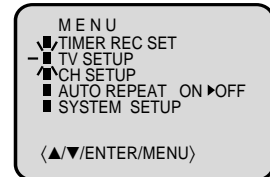

- 2 Press **▲** or **▼** to select "SURROUND". Then press **ENTER** to select "ON".

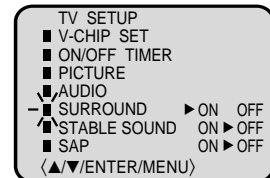

- 3 Press **TV MENU** repeatedly until the menu screen is cleared.

To cancel the surround sound mode:

Follow the above step 2, then press **ENTER** to select "OFF" position. Press **TV MENU** repeatedly until the menu screen is cleared.

Setting the stable sound

The stable sound feature limits the highest volume level to prevent extreme changes in volume when the signal source is changed.

- 1 Press **TV MENU** in the TV/VCR mode. Press **▲** or **▼** to select "TV SETUP", then press **ENTER**.

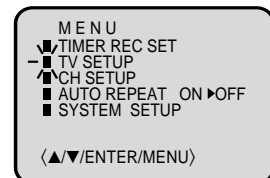

- 2 Press **▲** or **▼** to select "STABLE SOUND". Then press **ENTER** to select "ON".

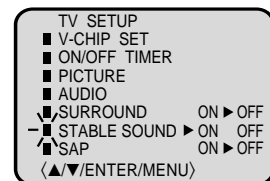

- 3 Press **TV MENU** repeatedly until the menu screen is cleared.

To cancel the stable sound mode:

Follow the above step 2, then press **ENTER** to select "OFF" position. Press **TV MENU** repeatedly until the menu screen is cleared.

Stereo recording and playback / Second Audio Program (SAP)

Stereo recording and playback

The VHS Hi-Fi audio system permits high fidelity recording of MTS STEREO TV broadcasts.

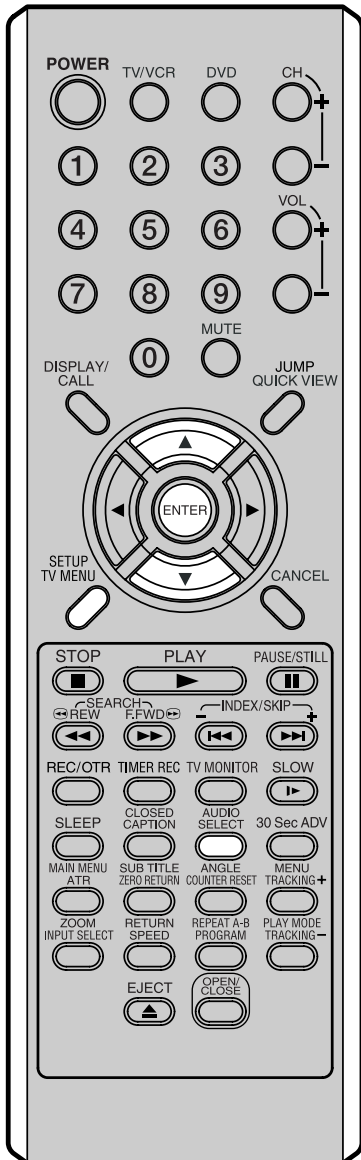

When a MTS STEREO broadcast is received, the word STEREO will appear on the screen and the program can be viewed or recorded in stereo. The Hi-Fi STEREO recording procedure is the same as for normal recordings.

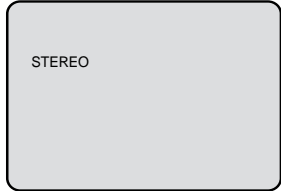

NOTE:

When using a CATV system, stereo TV programs may be transmitted over a mono cable channel. In this case the word "STEREO" will not appear and the sound will be in mono.

Output selection

When viewing an MTS STEREO TV program, or playing a prerecorded VHS Hi-Fi STEREO video tape, press **AUDIO SELECT** to select how the audio will be heard through the speakers. Normally set to the Hi-Fi STEREO position, this button can be set to the MONO position if the stereo broadcast or videotape audio is of poor quality. The "R" and "L" positions allow the audio from the Right or Left Hi-Fi channel to be heard over both TV speakers. This button has no effect when viewing a MONO video tape or TV program. Each time when you press the button, OUTPUT SELECTION display appears on the screen for several seconds. Refer to the chart below.

OUTPUT SELECTION	SOUND HEARD ON BOTH SPEAKERS
STEREO	STEREO
L ch	LEFT CHANNEL AUDIO
R ch	RIGHT CHANNEL AUDIO
MONO	MONO

Second Audio Program (SAP)

Your unit is fitted with a SAP broadcast system which enables you to switch to a second audio program when viewing a selected channel.

This function applies only when the program is broadcast in multi-languages through the SAP broadcast system.

1 Press **TV MENU** in the TV/VCR mode. Then press **▲** or **▼** to select "TV SETUP", then press **ENTER**.

2 Press **▲** or **▼** to select "SAP". Then press **ENTER** to select "ON".

Then press **TV MENU** until the menu screen is cleared.



NOTES:

- When playing back a tape that is not recorded in Hi-Fi stereo mode, the audio will automatically be monaural.
- When listening to a VHS Hi-Fi video tape or MTS broadcast through the VHF/UHF jack (Audio/Video cord not connected), the sound will be monaural.

Listening to SAP

When the unit is turned on or a channel selection is made, make certain the letters "SAP" appear on the screen. This means that the "Second Audio Program" broadcasting is available.

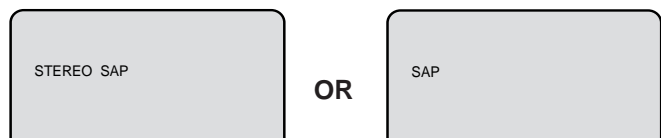

Duplicating a video tape

Duplicating a video tape

If you connect the unit to another VCR or camcorder, you can duplicate a previously recorded tape. Make all connections before turning on the power.

- 1 Load a blank cassette tape with the erase prevention tab intact into the recording unit. Load a previously recorded tape into the playback VCR or CAMCORDER.
- 2 Press **SPEED** to select the desired tape speed SP or SLP. It is recommended that you set the speed to the SP mode on the recording unit for best results.
- 3 Press **INPUT SELECT** to select AUDIO/VIDEO input position. "LINE 1" or "LINE 2" will appear on the screen.

LINE1: on the rear panel
LINE2: on the front panel

- 4 Press **REC/OTR** on the recording unit, then press **PAUSE/STILL**.
- 5 Press the **PLAY** button on the playback VCR or CAMCORDER, then press the **PAUSE/STILL** button.
- 6 Release the recording pause and the playback still simultaneously to begin the duplicating process.

Connection with second Video recorder

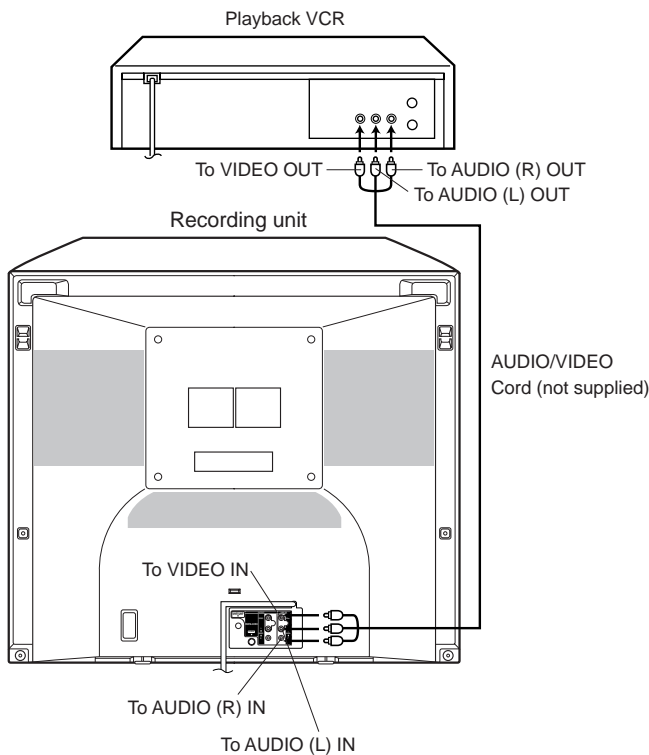

Connection with Video camera

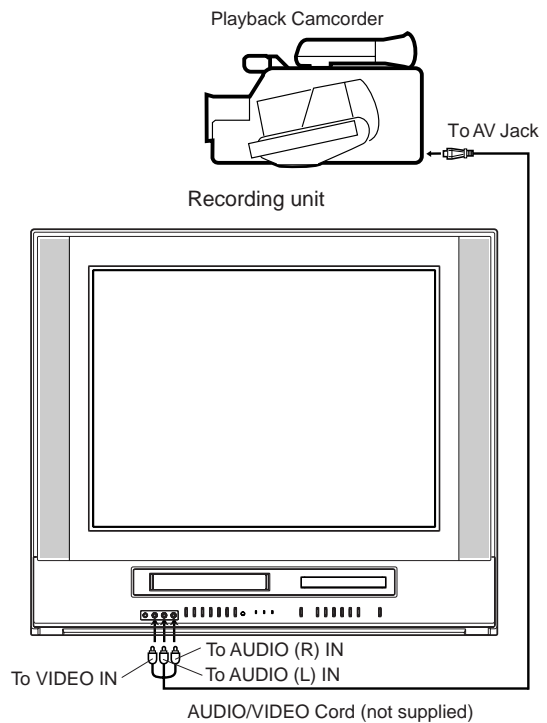

For duplicating a previously recorded tape from a camcorder, follow the camcorder manufacturer's instructions. A typical camcorder dubbing hookup is shown above.

This unit applies to DVD discs from Region 1 only.
 The loaded Disc (DVD, Audio-CD and mp3-CD) will be recognized automatically.
 The suitable Disc-formats are: DVD, CD-R and CD-RW.
 Some CD-R/RW discs may be incompatible.

WARNING

Do not attempt to play DVD-ROM, DVD-Audio, CDV, Video-CD, CD-G or Photo CD. These formats are not supported by this model.

Title

When two or more movies are recorded on a disc, the disc is divided into two or more sections. Each section is called a "TITLE".

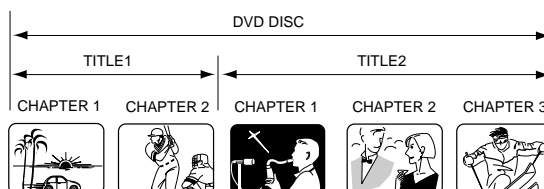

Chapter

The titles can be subdivided into many sections. Each section is called a "CHAPTER".

Track

An Audio CD can contain several items. Each item is called a track.

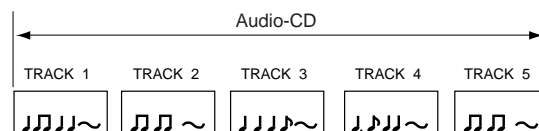

Removing Disc from Case

Be sure to hold the edge of disc. Do not touch the surface of the disc.
 Pick up the disc gently from the case.

- Do not scratch the disc.
- Do not get dirt on the surface of the disc.
- Do not stick a label or adhesive tape on the disc.
- Do not drop or bend the disc.

Storing Disc

- Store the disc in the case to avoid risk of scratches, dirt or damage.
- Do not leave disc exposed to direct sunlight or in hot or humid places.

Cleaning Disc

Wipe the disc with a clean, dry cloth from center to edge.

- Do not wipe the disc around in a circle.
- Do not use liquid or aerosol cleaners.

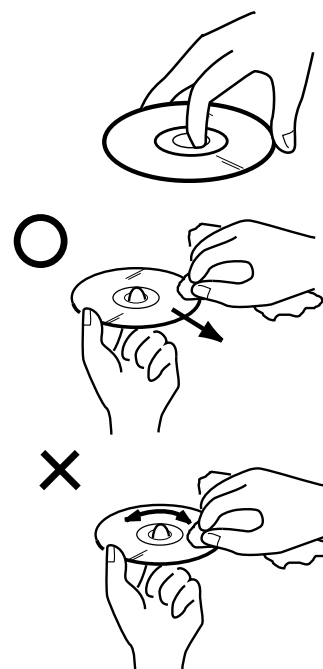

Preparation / Status display of disc

The following pages describe the setup/operation in DVD mode.

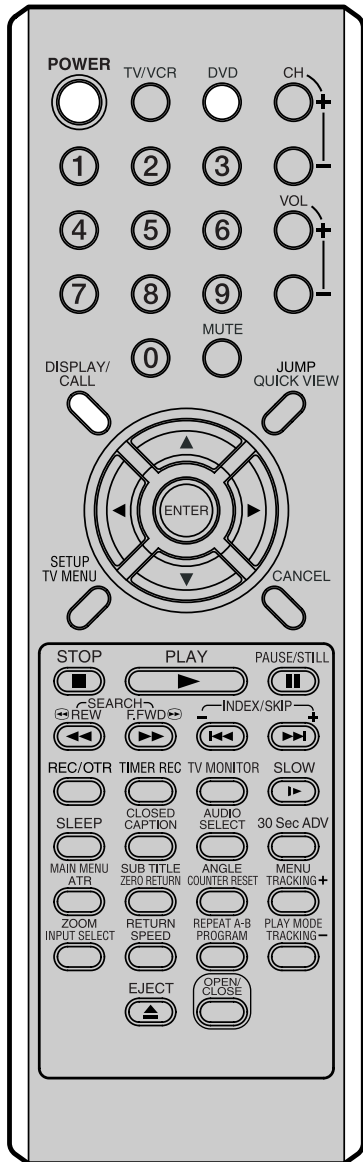

NOTE:
If the unit does not operate properly: Static electricity, etc., may affect the player's operation. Disconnect the AC power cord once, then connect it again.

Preparation

Before DVD/CD operation, please make preparations as follows.

- 1 Insert the AC cord plug into a standard 120V 60Hz polarized AC outlet.
 - If the AC cord plug is plugged in for the first time, wait for about 5 seconds before pressing **POWER**.
- NOTE:** When connecting to other equipment, unplug the unit from the AC outlet.
- 2 Press **POWER** on the unit or on the remote control to turn on the unit. The POWER indicator will light.
 - Every time you press **POWER**, the TV/DVD starts from TV mode.
 - When using an amplifier, switch on the amplifier.
- 3 Press **DVD** to select DVD mode. The DVD startup screen will appear on the screen.



Status display of disc

Press **DISPLAY/CALL**. The status display of the disc will appear on the screen.

DVD

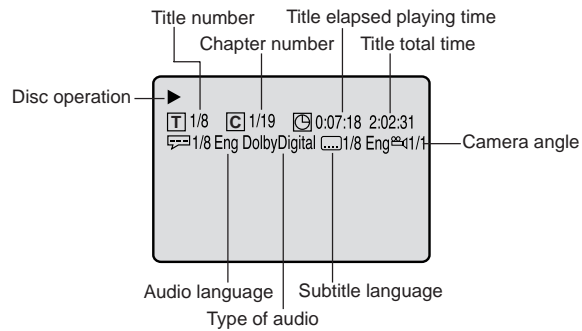

To make status display disappear, press **DISPLAY/CALL** again.

Audio CD

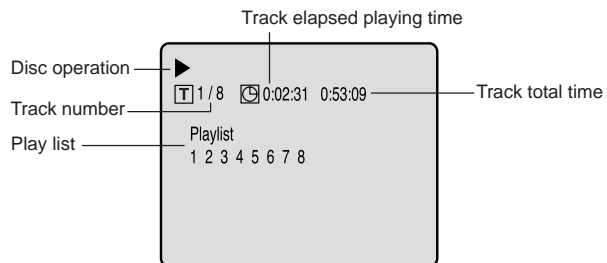

- When you play a CD disc, the status display will appear and remain on the screen.

Playback procedure

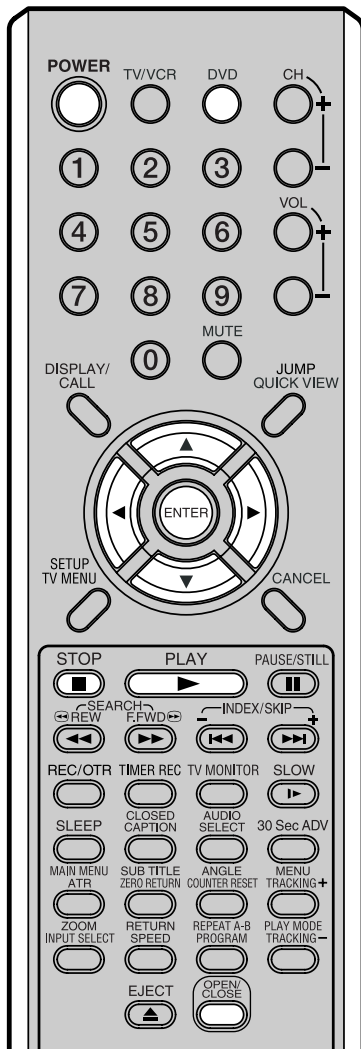

- 1 Press **DVD** to select DVD mode. Press **OPEN/CLOSE** on the unit or the remote control. The disc tray will open.

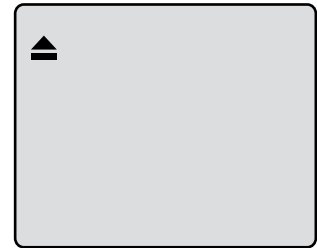

- 2 Place a disc onto the tray. Position it with the printed label side up, align it with the guides, and place it in its proper position.

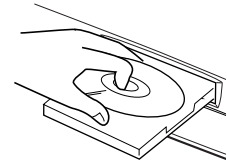

- 3 Press **OPEN/CLOSE** or **PLAY**. The disc tray closes automatically. On the TV-screen, ▲ changes to "Ⓢ" and then playback commences.

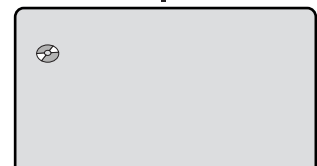

- A menu screen will appear on the TV screen, if the disc has a menu feature.

- 4 Press ▲/▼ or ◀/▶ to make a selection.

- 5 Press **ENTER**.
 - Title is selected and play commences.

- 6 Press **STOP** to end playback.
 - The unit memorizes the stopped point, depending on the disc. "■" appears on the screen. Press **PLAY** to resume playback (from the scene point).
 - If you press **STOP** again or unload the disc ("■" appears on the screen.), the unit will clear the stopped point.

- 7 Press **OPEN/CLOSE**. The disc tray opens. Remove the disc and press **OPEN/CLOSE** then press **POWER**. The disc tray closes automatically and unit turns off.

NOTES:

- If a non-compatible disc is loaded, "Incorrect Disc", "Region Code Error" or "Parental Error" will appear on the TV screen according to the type of loaded disc. If these appear, check your disc again (see pages 43 and 55).
- Some discs may take a minute or so to start playback.
- When you set a single-faced disc label downwards (ie. the wrong way up) and press **PLAY** or **OPEN/CLOSE** on the unit, "Ⓢ" will appear on the display for about 6 seconds and then "No Disc" or "Incorrect Disc" will be displayed.
- Some playback operations of DVDs may be intentionally fixed by software producers. Since this unit plays DVDs according to the disc contents the software producers designed, some playback features may not be available. Also refer to the instructions supplied with the DVDs.

Special playback

Note: There may be a slight delay between when you press the button and when the function is activated.

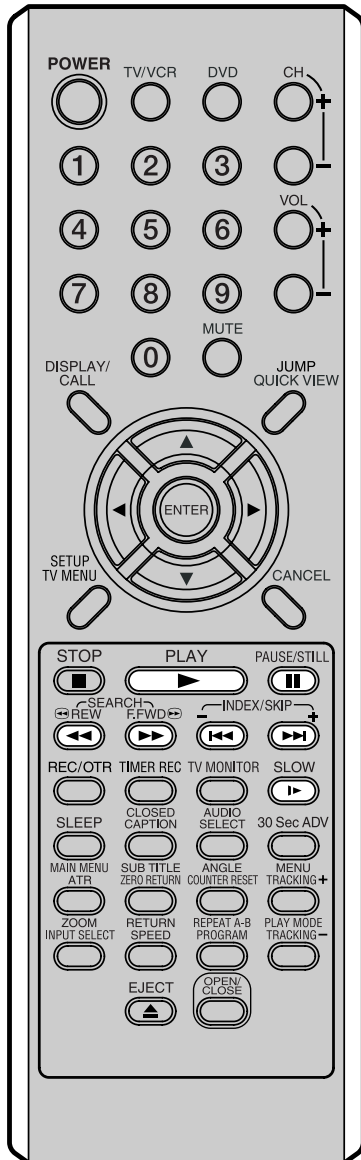

NOTE:

The unit is capable of holding a still video image or On screen display image on your television screen indefinitely. If you leave the still video image or On screen display image displayed on your TV for an extended period of time, you risk permanent damage to your television screen. Projection televisions are especially susceptible to such damage.

Fast Forward Playback

Press **SEARCH** **▶▶** during normal playback.

Each press of the **SEARCH** **▶▶** button will increase the speed of the search **▶▶** (x 2), **▶▶▶** (x 4), **▶▶▶▶** (x 8), **▶▶▶▶▶** (x 15).

[(CD: **▶▶** (x 2), **▶▶▶** (x 4), **▶▶▶▶** (x 8), **▶▶▶▶▶** (x 20))]

- To resume normal playback, press **PLAY**.

Review Playback

Press **SEARCH** **◀◀** during normal playback.

Each press of the **SEARCH** **◀◀** button will increase the speed of the search **◀◀** (x 2), **◀◀◀** (x 4), **◀◀◀◀** (x 8), **◀◀◀◀◀** (x 15).

[(CD: **◀◀** (x 2), **◀◀◀** (x 4), **◀◀◀◀** (x 8), **◀◀◀◀◀** (x 20))]

- To resume normal playback, press **PLAY**.

Still Playback

Press **PAUSE/STILL** during normal playback to pause playback.

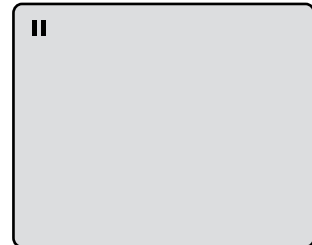

To resume normal playback, press **PLAY**.

Frame Advance

Press **PAUSE/STILL** during still playback.

One frame is advanced each time you press **PAUSE/STILL**.

To resume normal playback, press **PLAY**.

Slow-motion Playback

Press **SLOW** (**▶▶**) during normal playback or still playback. Each press of **SLOW** will change the speed of the slow x1/2, x1/4, x1/6, x1/8.

- To resume normal playback, press **PLAY**.
- To resume the still playback, press **PAUSE/STILL**.

Locating a chapter or track

Press **SKIP** (**▶▶▶**) Forward or **SKIP** (**◀◀◀**) Reverse during playback to locate a chapter that you want to watch.

Each time you press the button, a chapter or track is skipped.

mp3 playback

This player can play back the mp3-data which has been recorded on CD-R or CD-RW. To produce the mp3-data, you need a Windows-PC with CD-ROM drive and a mp3-encoding Software (not supplied). The Apple-HFS-System cannot be played.

mp3 CD Information

Limitations on mp3 CD playback

- mp3 CD is the disc that is standardized by ISO9660, its file name must include 3-digits extension letters, "mp3".
- The directory and file names of the mp3 CD must correspond to the ISO standardized files.
- This unit can read 200 files per disc. If one directory has more than 200 files, it reads up to 200 files, the remaining files will be omitted.
- mp3 CD's cannot be used for playback for the purpose of recording.
- It may take more than one minute for this unit to read mp3 files depending on its structure.
- Music recorded by "Joliet Recording Specification" can be played back, the file name is displayed on the screen. Long file names will be condensed.
- The music files recorded by "Hierarchical File System" (HFS) cannot be played.

Notes on mp3 files

To play back an mp3 CD in the recorded order,

1. Use mp3 software that records data alphabetically or numerically.
2. Name each file including two-digit or three-digit number (e.g. "01" "02" or "001" "002").
3. Refrain from making too many sub-folders.

CAUTION:

- Some mp3 CDs cannot be played back depending on the recording conditions.
- The CD-R/RW that has no music data or non-mp3 files cannot be played back.

Preparation:

- Turn ON the TV and set to the video input mode.
- Press **DVD** to select the DVD mode.

- 1 Press **OPEN/CLOSE**.
The disc tray will open.
Place a disc onto the tray.

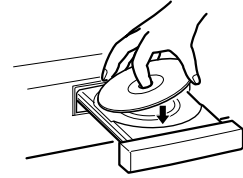

- 2 Press **PLAY** or **OPEN/CLOSE**.
The disc tray closes automatically.
On the TV-screen, "Scanning..." will appear. Scanning will take as much time as the number of files.

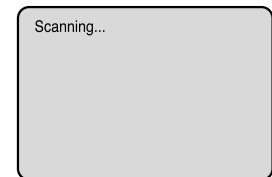

- 3 A mp3 menu screen will appear on the TV screen.
Press **▲/▼** or **◀/▶** or **Number buttons (0-9)** to select the desired track, then press **ENTER**. Track is selected and play commences.

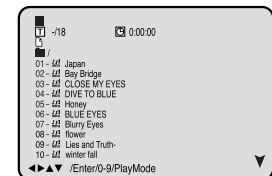

- In case the folder includes more than 11 tracks, press **◀** or **▶** to display next track list.

- 4 Press **STOP** to end playback.
 - The unit records the stopped point. "■" appears on the screen. Press **PLAY** to resume playback (from the stopped point).
 - If you press **STOP** again or unload the disc, the unit will clear the stopped point.

- 5 Then press **OPEN/CLOSE**.
The disc tray opens.
Remove the disc and press **POWER**.
The disc tray closes automatically and the unit turns off.

NOTES:

- During mp3-Playback, you cannot use **SEARCH** or **A-B Repeat** functions.
- You can use **Repeat (Track or All)**, **Random** functions and **Program playback** for mp3 CD Playback. (See page 49)

Zooming / Locating desired scene

Zooming

This unit will allow you to zoom in on the frame image. You can then make selections by switching the position of the frame.

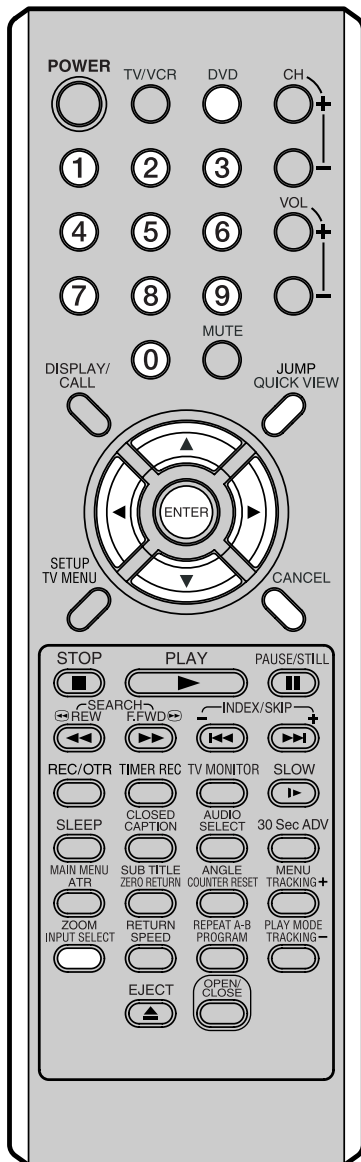

- 1 Press **DVD** to select DVD mode.
Press **ZOOM** during playback.
The center part of the image will be zoomed in.
Each press of **ZOOM** will change the ZOOM Q1 (x 2), Q2 (x 3) and Q3 (x 4).

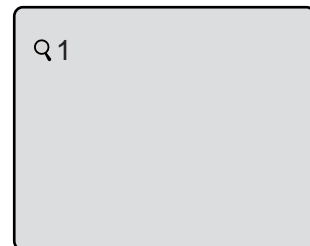

- 2 Press **▲/▼/◀/▶** to view a different part of the frame. You may move the frame from the center position to UP, DOWN, LEFT or RIGHT direction.
- 3 In the zoom mode press **ZOOM** repeatedly to return to a 1:1 view (Q Off).

Locating Desired Scene

Use the title, chapter and time recorded on the disc to locate the desired point to play back.

- 1 Press **JUMP** during playback.

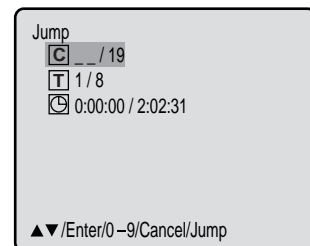

- 2 Press **▲** or **▼** to select the "[C] (Chapter)", "[T] (Title/Track)" or "[G] (Time)".
- 3 Press **Number buttons (0-9)** to input the number.

- If you input a wrong number, press **CANCEL**.
- Refer to the package supplied with the disc to check the numbers.

- 4 Press **ENTER**.

- Playback starts.
- When you change the title, playback starts from Chapter 1 of the selected title.
- Some discs may not work in the above operation.

NOTES:

- You can select the Pause, Slow or Search playback in the zoom mode.
- Some discs may not respond to zoom feature.

Repeat/Random/Program playback and Repeat A-B

Press **PLAY MODE** during playback or stop mode.
Each time you press **PLAY MODE**, playback mode changes as follows.

DVD

On screen display	Operation
↻ Title:	Repeats the current title.
↻ Chapter:	Repeats the current chapter.
↻ Off:	Resumes normal playback.

- During stop mode, **PLAY MODE** key is not effective.

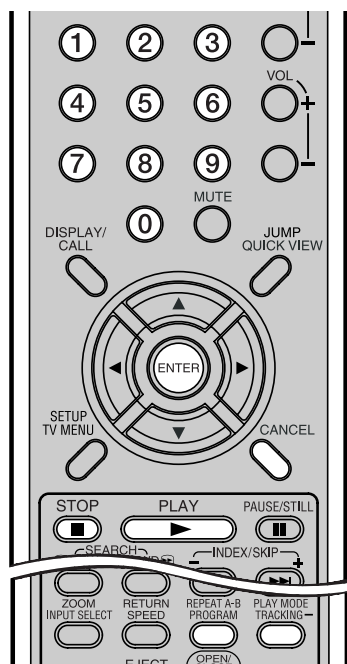

NOTES:

- If you enter a incorrect number – press **CANCEL**.
- To cancel program play, press **STOP** 3 times.
- To clear the programs on the program menu – press **CANCEL** until all programs are cleared.
- The program is cancelled when you open the disc tray or turn off the power.

Repeat A-B

Repeat A-B playback allows you to repeat material between two selected points.

- 1 Press **REPEAT A-B** during playback.
The start point is selected.

- 2 Press **REPEAT A-B** again.
The end point is selected. Playback starts at the point that you selected. Playback stops at the end point, returns to Point A automatically, then starts again.

To resume normal playback press **REPEAT A-B** again. "↻ Off" appears on the screen.

NOTES:

- Some discs may not work with the repeat operation.
- In Repeat A-B mode, subtitles near point A or B may not appear.
- You may not be able to set Repeat A-B, depending on the scenes of the DVD.
- Repeat A-B does not work with MP3 CD and interactive DVDs.

Audio CD /mp3 CD

On screen display	Operation
↻ All:	Repeats entire disc.
↻ Track:	Repeats the current track.
Random Play:	Plays the tracks in random order.
*Program:	Plays the tracks in program order.
(Status display):	Resumes normal playback.

- During stop mode, you cannot select "↻ Track".

*Program menu

Use **number buttons (0–9)** to enter the track's number you want to program, then press **ENTER**. The track number and total time are displayed. Repeat this step to enter additional tracks. When you have finished entering tracks, press **PLAY** to start Program playback. A playlist of your programmed tracks is displayed.

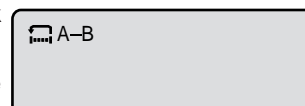
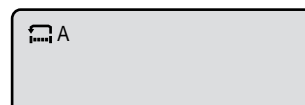
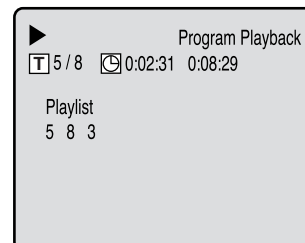
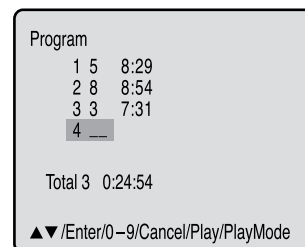

Changing soundtrack language / Subtitles

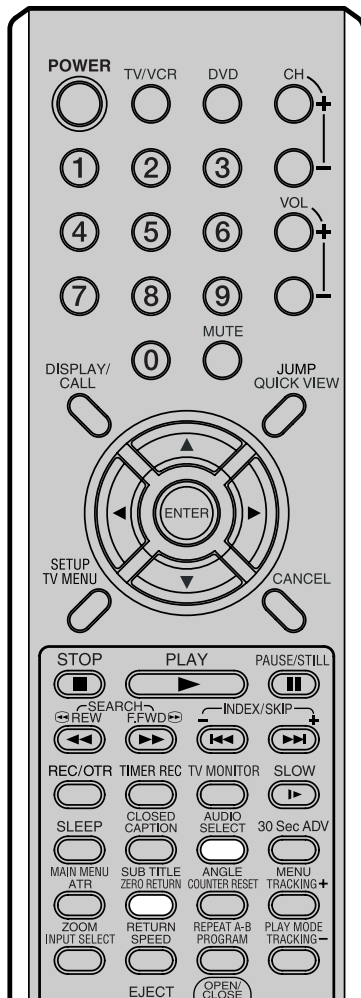

NOTES:

- If the desired language is not heard after pressing **AUDIO SELECT** several times, the language is not recorded on the disc.
- Changing soundtrack language is cancelled when you open the disc tray. The initial default language or available language will be heard if the disc is played back again.
- Changing subtitle language is cancelled when you open the disc tray or turn the power off.
- Some functions may not work on some DVDs. You may not be able to turn subtitles on or off or change subtitles. While playing the DVD, the subtitle may change when:
 - you open or close the disc tray
 - you change the title.
- In some cases, the subtitle language is not changed to the selected one immediately.

Changing soundtrack language

You can select the language when you play a multilingual disc.

- 1 Press **AUDIO SELECT** during playback.

2/8 Fra Dolby Digital

The current soundtrack language will appear.

- 2 Press **AUDIO SELECT** repeatedly until the desired language is selected.

1/8 Eng Dolby Digital

The on-screen display will disappear after a few seconds.

Subtitles

Turning the Subtitles On and Off

When playing back a disc recorded with subtitles, you can turn the subtitles on or off.

Press **SUB TITLE** during playback until "Off" appears.

Off

NOTE:

Subtitles are not available on all discs.

Changing the subtitle language

You can select the language when playing back a disc recorded with multi-lingual subtitles.

- 1 Press **SUB TITLE** repeatedly during playback until your desired language appears.

1/32 Eng

- 2 The on-screen display will disappear after a few seconds.

Changing angles / Title selection / DVD menu

Changing angles

When playing back a disc recorded with multi-angles, you can change the view angle.

- 1 Press **ANGLE** during playback.

The current angle will appear.

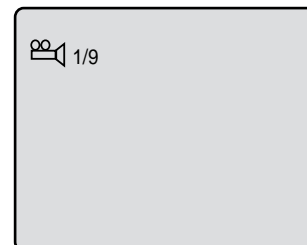

- 2 Press **ANGLE** repeatedly until the desired angle is selected.

Title selection

Two or more titles are recorded on some discs. If the title menu is recorded on the disc, you can select the desired title.

- 1 Press **MAIN MENU** during playback. Title menu appears on the screen.

- 2 Press **▲/▼** or **◀/▶** to select the desired title.

- 3 Press **ENTER** or **PLAY**. The playback of the selected title will start.

DVD menu

Some DVDs allow you to select the disc contents using the menu.

When you play back these DVDs, you can select the subtitle language and sound-track language, etc. using the DVD menu.

- 1 Press **MENU** during playback. The DVD menu appears on the screen.

- Press **MENU** again to resume playback at the scene when you pressed **MENU**.

- 2 Press **▲/▼** or **◀/▶** to select the desired item.

- 3 Press **ENTER**. The menu continues to another screen. Repeat steps 2 and 3 to set additional items if any.

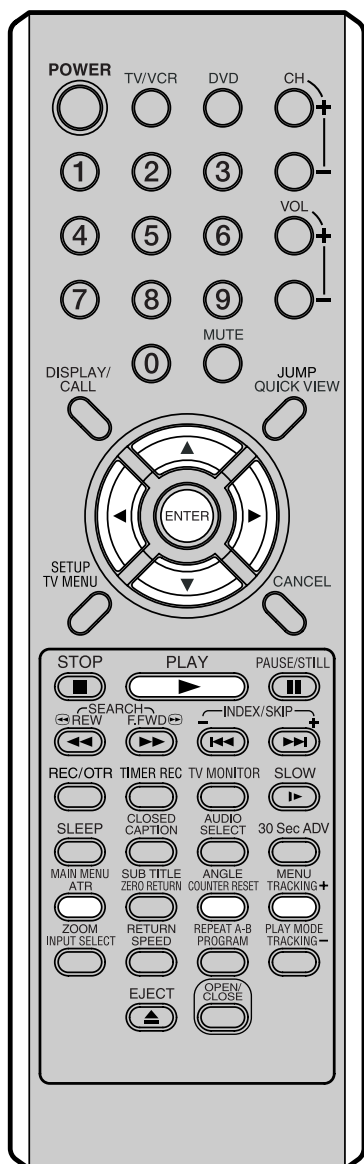

NOTES:

- Depending on the DVD, you may not be able to change the angles even if multi-angles are recorded on the DVD.
- Depending on the DVD, you may not be able to select the title. Depending on the DVD, a "title menu" may simply be called a "menu" or "title" in the instructions supplied with the disc.

Setting language

You can change the default settings to customize performance to your preference.

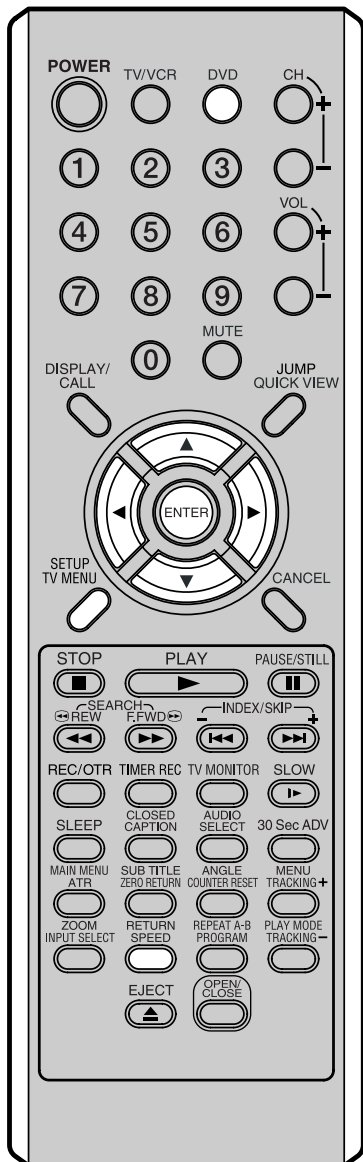

- 1 Press **DVD** to select DVD mode.
Press **SETUP** in the stop mode or No Disc.
Press **▲** or **▼** to select "Language", then press **▶** or **ENTER**.

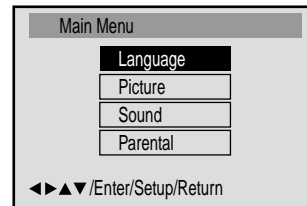

- 2 Press **▲** or **▼** to select "OSD Language", then press **▶** or **ENTER**.

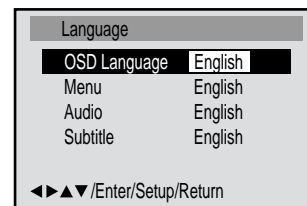

- 3 Press **▲** or **▼** to select desired language (e.g. English), then press **ENTER**.
The menu returns to "Language" menu automatically.

- If you want to return to the previous menu, press **◀** or **RETURN**.

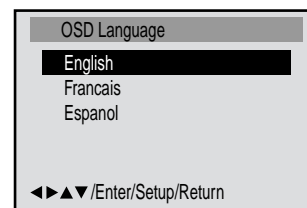

- 4 Repeat steps 2-3 for other "Language" setting.

Other Selection: (Menu/Audio/Subtitle)

If you want to select another language, enter the language code (see the Language code list on page 58).

Off: (subtitle)

Subtitles do not appear.

- 5 Press **SETUP** to remove the Menu screen.

NOTES:

- If the selected soundtrack language is not recorded on the disc, the original language will be heard.
- If the selected subtitle language is not recorded on the disc, the first-priority language is selected.

Setting the aspect ratio of TV screen / Setting on screen display

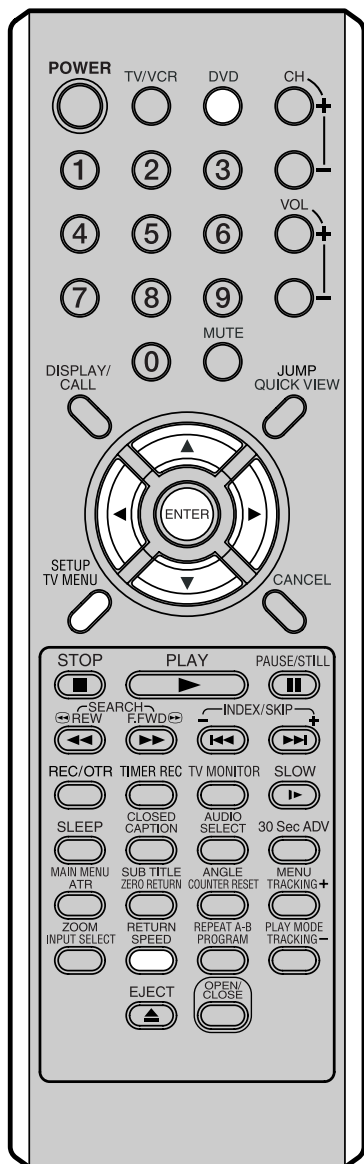

NOTE:

If the DVD disc is not formatted in the pan & scan style, it displays 4:3 style.

Setting the aspect ratio of TV screen

You can select the aspect ratio for your TV.

- 1 Press **DVD** to select DVD mode.
Press **SETUP** in the stop mode or No Disc.
Press **▲** or **▼** to select "Picture", then press **▶** or **ENTER**.

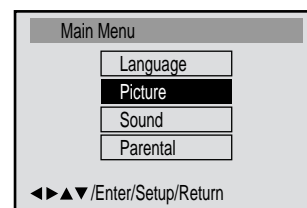

- 2 Press **▲** or **▼** to select "TV Screen", then press **▶** or **ENTER**.

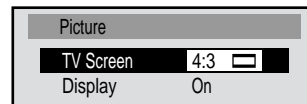

- 3 Press **▲** or **▼** to select your desired screen type, then press **ENTER**.

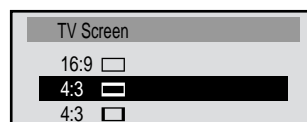

You have the following screen sizes to choose from:

16:9 Wide screen

Select this mode when connecting to a wide-screen TV. A wide screen picture is displayed full size.

4:3 Letterbox

Select this mode when connecting to a conventional TV. When playing back a wide screen-DVD disc, it displays the wide picture with black bands at the top and bottom of screen.

4:3 Panscan

It displays the wide picture on the whole screen with left and right edges automatically cut off.

- If you want to return to the previous menu, press **◀** or **RETURN**.

- 4 Press **SETUP** to remove the Menu screen.

Status on screen display

On screen display can be switched on or off when you press the buttons.

- 1 Press **DVD** to select DVD mode. Press **SETUP** in the stop mode or No Disc. Press **▲** or **▼** to select "Picture", then press **▶** or **ENTER**.

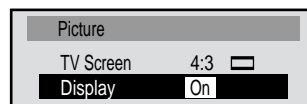

- 2 Press **▲** or **▼** to select "Display".

- 3 Press **▶** or **ENTER** to select "On" or "Off".

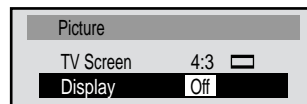

- On:** On screen displays appear when you press the buttons (factory setting).
- Off:** On screen displays do not appear when you press any buttons.

- If you want to return to the previous menu, press **◀** or **RETURN**.

- 4 Press **SETUP** to remove the Menu screen.

Dynamic Range Control

DRC (Dynamic Range Control) enables you to control the dynamic range so as to achieve a suitable sound for your equipment.

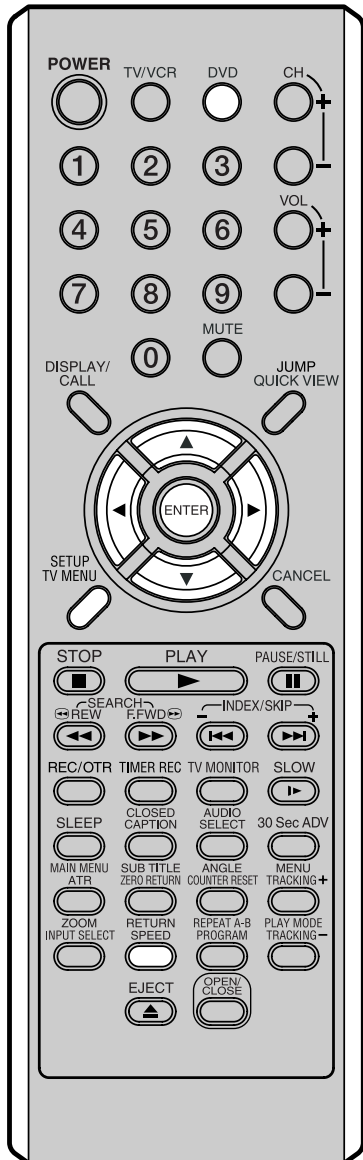

- 1 Press **DVD** to select DVD mode.
Press **SETUP** in the stop mode or No Disc.
Press **▲** or **▼** to select "Sound".

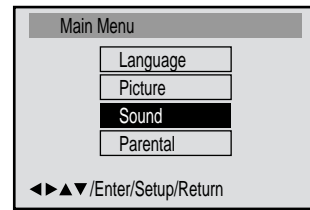

- 2 Press **▶** or **ENTER** to select "DRC".

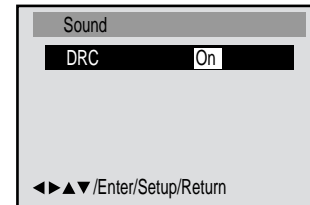

- 3 Press **▶** or **ENTER** to select "On" or "Off".

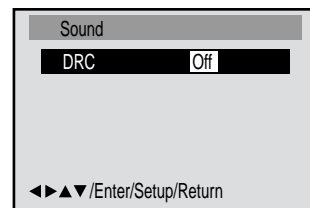

- If you want to return to the previous menu, press **◀** or **RETURN**.

- 4 Press **SETUP** to remove the Menu screen.

NOTES:

- This function works only during playback of Dolby Digital recorded discs.
- The level of Dynamic Range Reduction may differ depending on DVD video disc.

Parental control setting

If you want to limit the types of discs that can be played, set up the Parental Control feature.

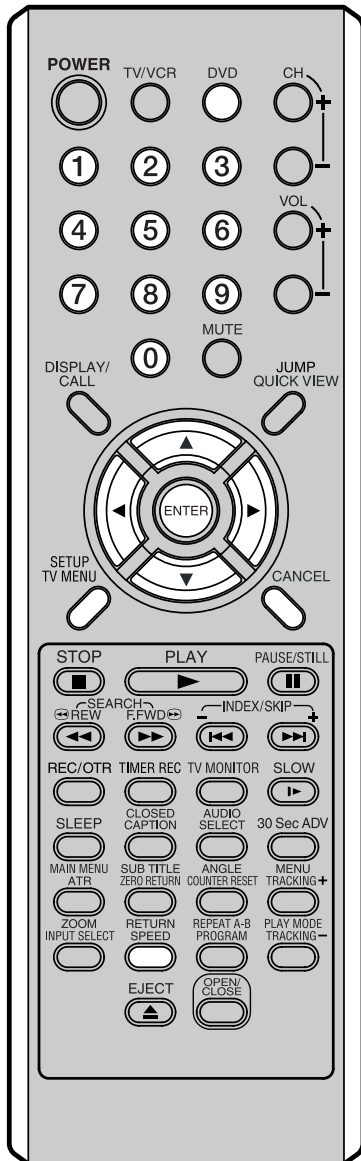

NOTES:

- If each setup (P.52–56) has been completed, the unit can always be operated under the same conditions (especially with DVD discs). Each setup will be retained in the memory when you turn the power off.
- Depending on the discs, the unit cannot limit playback.
- Some discs may not be encoded with specific rating level information though its disc jacket says “adult.” For those discs, the parental control restriction will not work.

- 1 Press **DVD** to select DVD mode. Press **SETUP** in the stop mode or No Disc. Press **▲** or **▼** to select “Parental”, then press **▶** or **ENTER**.

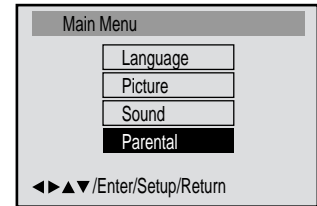

- 2 Press **▲** or **▼** to select “Parental Level”, then press **▶** or **ENTER**.

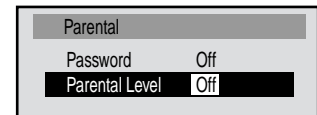

- 3 Press **▲** or **▼** to select a level from Off or 1–8. Press **▶** or **ENTER** to set the selected level.

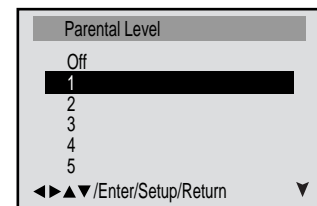

- **Level Off:** The parental control setting does not function.
- **Level 8:** Almost all DVD software can be played back.
- **Level 1:** DVD software for adults cannot be played back.
- Select from the level 1 to level 8. The limitation will be more severe as the level number is lower.

- 4 Press **▲** or **▼** to select “Password”, then press **▶** or **ENTER**.

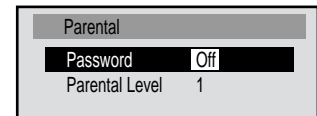

- 5 Press **number buttons (0–9)** for the password. Don't forget the password.
 - If you input a wrong number, press **CANCEL**.

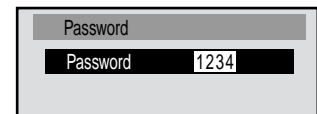

- 6 Press **ENTER** to store the password.

Note: Now the rating is locked and the setting cannot be changed unless you enter the correct password.

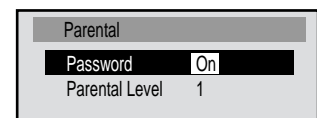

- If you want to return to the previous menu, press **◀** or **RETURN**.

- 7 Press **SETUP** to remove the parental control screen.

To change the parental level

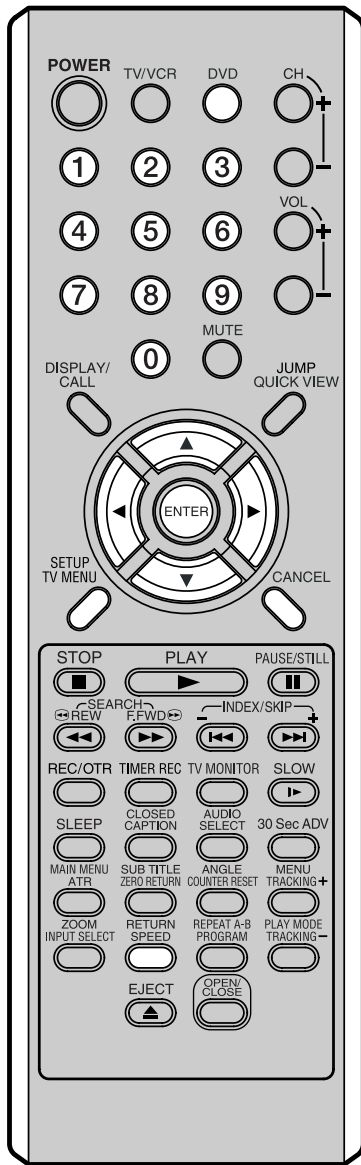

NOTES:

If you forget the password...

1. Disconnect the AC cord plug from the AC outlet and leave the unit unplugged for more than two minutes.
2. Insert the AC cord plug again.
3. In the No Disc DVD mode, press and hold the STOP button on the unit, and simultaneously press and hold the 7 button on the remote control for more than 3 seconds.
4. "PASSWORD CLEAR" appears on the screen. The password has been cleared.

- 1 Press **DVD** to select DVD mode. Press **SETUP** in the stop mode or No Disc. Press **▲** or **▼** to select "Parental", then press **▶** or **ENTER**.

- 2 Press **▲** or **▼** to select "Password", then press **▶** or **ENTER**.

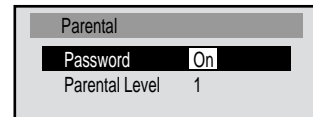

- 3 Press **number buttons (0-9)** to enter the password you have stored.

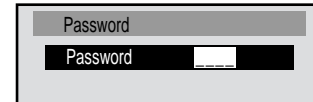

- If you input a wrong number, press **CANCEL**.

- 4 Press **ENTER**. The password is now Off.

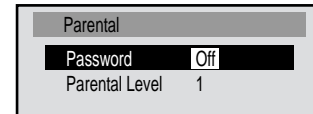

- 5 Press **▲** or **▼** to select "Parental Level". Then press **▶** or **ENTER**. The Parental Level screen is displayed.

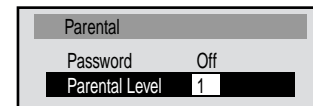

- 6 Press **▲** or **▼** to select a level from Off or 1-8 and then press **▶** or **ENTER**.

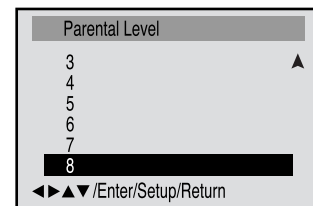

- 7 Press **▲** or **▼** to select "Password" and then press **▶** or **ENTER**.

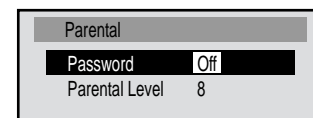

- 8 Press **number buttons (0-9)** to enter a 4-digit password.

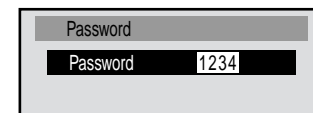

Note: You can enter a new password.

- 9 Press **ENTER**. The parental level is now changed and locked.

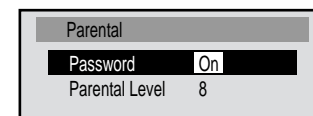

- If you want to return to the previous menu, press **◀** or **RETURN**.

- 10 Press **SETUP** to remove the parental control screen.

Temporary disabling of rating level by DVD disc

Depending on the DVD disc, the disc may try to temporarily cancel the rating level that you have set. It is up to you to decide whether to cancel the rating level or not.

- 1 Load a DVD disc and press **PLAY** (see page 45).

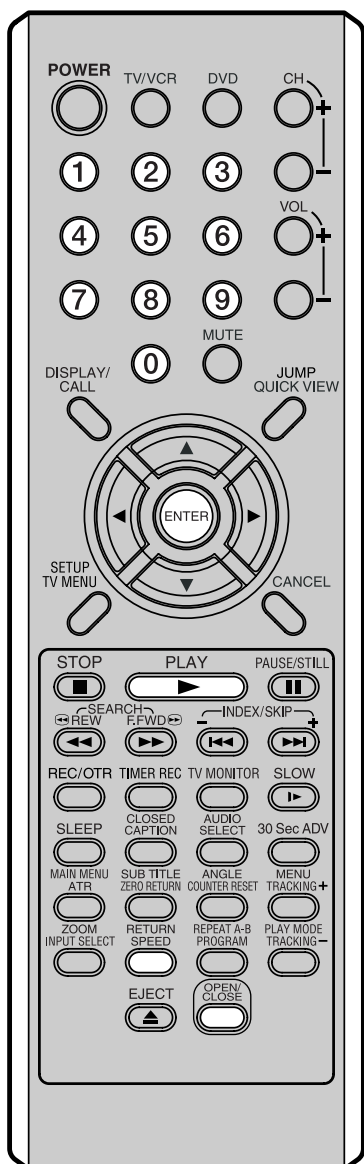
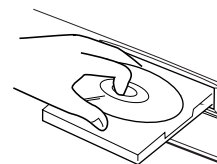

- 2 If the DVD disc has been designed to temporarily cancel the Rating level, the screen which appears after inserting a DVD will change, depending on which disc is played. If you select "YES" with the **ENTER** key, "Your disc exceeds the parental control level." screen will then appear.

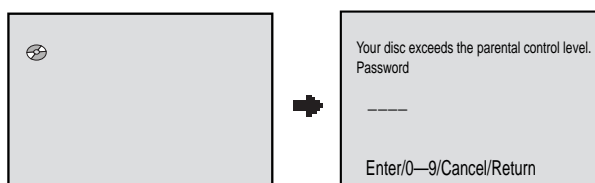

- 3 If you wish to cancel the set rating level temporarily, enter the 4-digit password. Then press **ENTER**. Alternatively, if the password has not been set, playback will commence. If you don't know (or have forgotten) the password, select "STOP". The setting screen will disappear. Press **OPEN/CLOSE** to remove the disc.

To quit entering, press **RETURN**.

- 4 Playback will commence if the entered password was correct.

NOTE:

The rating level will remain disabled until the disc is ejected. When the disc is ejected, the original rating level will be set again automatically.

Language code list

Enter the appropriate code number for the initial settings "AUDIO", "SUBTITLE" and/or "MENU LANGUAGE" (see page 52).

Language Name	Code	Language Name	Code	Language Name	Code
Abkhazian	1112	Fiji	1620	Lingala	2224
Afar	1111	Finnish	1619	Lithuanian	2230
Afrikaans	1116	French	1628	Macedonian	2321
Albanian	2927	Frisian	1635	Malagasy	2317
Amharic	1123	Galician	1722	Malay	2329
Arabic	1128	Georgian	2111	Malayalam	2322
Armenian	1835	German	1415	Maltese	2330
Assamese	1129	Greek	1522	Maori	2319
Aymara	1135	Greenlandic	2122	Marathi	2328
Azerbaijani	1136	Guarani	1724	Moldavian	2325
Bashkir	1211	Gujarati	1731	Mongolian	2324
Basque	1531	Hausa	1811	Nauru	2411
Bengali; Bangla	1224	Hebrew	1933	Nepali	2415
Bhutani	1436	Hindi	1819	Norwegian	2425
Bihari	1218	Hungarian	1831	Oriya	2528
Breton	1228	Icelandic	1929	Panjabi	2611
Bulgarian	1217	Indonesian	1924	Pashto, Pushto	2629
Burmese	2335	Interlingua	1911	Persian	1611
Byelorussian	1215	Irish	1711	Polish	2622
Cambodian	2123	Italian	1930	Portuguese	2630
Catalan	1311	Japanese	2011	Quechua	2731
Chinese	3618	Javanese	2033	Rhaeto-Romance	2823
Corsican	1325	Kannada	2124	Romanian	2825
Croatian	1828	Kashmiri	2129	Russian	2831
Czech	1329	Kazakh	2121	Samoan	2923
Danish	1411	Kirghiz	2135	Sanskrit	2911
Dutch	2422	Korean	2125	Scots Gaelic	1714
English	1524	Kurdish	2131	Serbian	2928
Esperanto	1525	Laothian	2225	Serbo-Croatian	2918
Estonian	1530	Latin	2211	Shona	2924
Faroese	1625	Latvian, Lettish	2232	Sindhi	2914
				Singhalese	2919
				Slovak	2921
				Slovenian	2922
				Somali	2925
				Spanish	1529
				Sundanese	2931
				Swahili	2933
				Swedish	2932
				Tagalog	3022
				Tajik	3017
				Tamil	3011
				Tatar	3030
				Telugu	3015
				Thai	3018
				Tibetan	1225
				Tigrinya	3019
				Tonga	3025
				Turkish	3028
				Turkmen	3021
				Twi	3033
				Ukrainian	3121
				Urdu	3128
				Uzbek	3136
				Vietnamese	3219
				Volapük	3225
				Welsh	1335
				Wolof	3325
				Xhosa	3418
				Yiddish	2019
				Yoruba	3525
				Zulu	3631

Problems and troubleshooting

Use the following check list for troubleshooting when you have problems with your unit. Consult your local dealer or service outlet if problems persist.

Be sure all connections are properly made when using with other units.

SYMPTOMS	CAUSE	POSSIBLE SOLUTIONS	PAGE
POWER			
No power.	The AC power cord is not connected.	Connect the AC power cord to the AC outlet.	5
Although the power is on, the unit does not operate.	Cassette or disc is not inserted.	Insert a video cassette or disc.	31, 45
	The TIMER REC buttons are depressed.	Press the TIMER REC buttons.	38
TV BROADCAST RECEPTION			
Poor or no picture.	TV station experiencing problems.	Try another channel.	19
	Picture control is not adjusted.	Check picture control adjustments.	29
	Possible local interference.	Check for source of reception disturbance.	61
	Antenna (CATV) connector is not connected or possible local interference.	Check CATV connection or VHF/UHF antenna, reposition or rotate antenna.	11, 12
Poor or no color.	TV station experiencing problems.	Try another channel.	19
	Picture control is not adjusted.	Check picture control adjustments.	29
	Possible local interference.	Check for source of reception disturbance.	61
	Antenna (CATV) connector is not connected or possible local interference.	Check CATV connection or VHF/UHF antenna, reposition or rotate antenna.	11, 12
Picture wobbles or drifts.	TV station experiencing problems.	Try another channel.	19
	Antenna (CATV) connector is not connected or possible local interference.	Check CATV connection or VHF/UHF antenna, reposition or rotate antenna.	11, 12
	Cable TV channel is scrambled.	Try another channel.	19
No CATV reception.	CATV connector is not connected.	Check all CATV connections.	12
	TV/CATV Mode menu option is set to the TV mode.	Set the TV/CATV Menu option to the CATV mode.	22
	Cable TV service interrupted.	Contact your Cable TV company.	12
No reception above channel 13.	TV/CATV Mode menu option is not set to the appropriate mode.	Make sure TV/CATV menu option is in the appropriate mode.	22
	UHF antenna is not connected.	Check UHF antenna.	11
Poor or no sound.	TV station experiencing problems.	Try another channel.	19
	Antenna (CATV) connector is not connected or possible local interference.	Check CATV connection or VHF/UHF antenna, reposition or rotate antenna.	11, 12
	Possible local interference.	Check for source of reception disturbance.	61
	The MUTE button is depressed.	Check the MUTE button has not been pressed.	20
TV shuts off.	TV station stopped broadcasting.	Tune new channel.	19
	Sleep timer is set.	Set Sleep Timer to "0".	20
Closed caption is not activated.	TV station experiencing problems or program tuned is not closed captions.	Try another channel.	19
	TV signal is weak.	Check CATV connection of VHF/UHF antenna, reposition or rotate antenna.	11, 12
	The CLOSED CAPTION button is not depressed.	Press the CLOSED CAPTION button to turn on the closed caption.	21
VCR			
TV recording does not work.	The video cassette's erase prevention tab is broken off.	Place a piece of adhesive tape over the hole.	31
Timer recording does not work.	The time is not set correctly.	Reset the present time.	16-18
	The recording start/end time is not set correctly.	Reset the start/end time.	38
Noise bars appear on the screen.	Tape is old or worn.	Replace the tape.	-
	Tracking adjustment is beyond range of automatic tracking circuit.	Adjust tracking manually using the TRACKING +/- buttons on the remote control.	33
	Video heads are dirty.	Clean the video heads.	60

Problems and troubleshooting (continued) / Video head cleaning

SYMPTOMS	CAUSE	POSSIBLE SOLUTIONS	PAGE
DVD			
The playback picture has occasional distortion.	The disc is dirty.	Eject the disc and clean it.	43
	It is in fast forward or fast reverse playback.	Some times a small amount of picture distortion may appear. This is not a malfunction.	–
The unit does not start playback.	No disc is inserted.	Insert a disc.	45
	An unplayable disc is inserted.	Insert a playable disc (Check the disc type and Region Number). This is a Region 1 player.	43
	The disc is placed upside down.	Place the disc with the playback side down.	45
	The disc is not placed within the guide.	Place the disc correctly inside the guide on the disc tray.	45
	The disc is dirty.	Clean the disc.	43
	The parental lock function is set.	Cancel the parental lock function or change the parental lock level.	55, 56
Playback does not follow the course of the disc's program	It is in the mode of repeat playback, memory playback, etc.	These operations may prevent proper progression of the contents.	–
⊘ appears on the screen.	The function is prohibited with the unit or the disc.	–	–
REMOTE CONTROL			
Remote control does not operate.	The remote control is not aimed at the sensor.	Aim the remote control at the remote sensor.	10
	Distance is too far or too much light in the room.	Operate within 5 m or reduce the light of the room.	10
	There is an obstacle in the path of the beam.	Clear the path of the beam.	10
	The batteries are weak.	Replace the batteries.	10
	The batteries are not inserted correctly.	Insert correctly.	10

Video head cleaning

Video head clogging

The video heads are the means by which the unit reads the picture from the tape during playback. In the unlikely event that the heads become dirty enough to be clogged, no picture will be played back. This can easily be determined if, during playback of a known good tape, there is good sound, but no picture (picture is extremely snowy). If this is the case, have the unit checked by qualified service personnel.

- NOTES:**
- DO NOT ATTEMPT TO CLEAN THE VIDEO HEADS OR SERVICE THE UNIT BY REMOVING THE REAR COVER.
 - Video heads may eventually wear out and should be replaced when they fail to produce clear pictures.
 - To help prevent video head clogging, use only good quality VHS tapes. Discard worn out tapes.

Specifications

GENERAL	20F500TDV	24F500TDV	27F500TDV
Power supply:	AC 120V 60Hz		
Power consumption:	Operation: 110W Stand by: 4W	Operation: 135W Stand by: 4W	Operation: 145W Stand by: 4W
Weight:	59.5lbs (27.0 kg)	79.4lbs (36.0 kg)	99.2lbs (45.0 kg)
Dimensions:	Width : 22-9/16 inches (573 mm) Height : 20-3/8 inches (517 mm) Depth : 19-1/8 inches (485 mm)	25-13/16 inches (655 mm) 22-13/16 inches (580 mm) 18-3/4 inches (477 mm)	29-1/8 inches (740 mm) 25-3/8 inches (645 mm) 19-7/16 inches (494 mm)
Inputs/Outputs:	In: 1Vp-p/75 ohm Out: 1Vp-p/75 ohm		
Video:	In: -8dBm/50 K ohm Out: -8dBm/1 K ohm		
Audio:	20Hz to 20,000Hz More than 90dB		
Hi-Fi frequency response:			
Hi-Fi dynamic range:			
TELEVISION			
Picture tube:	20" (508 mm diagonal)	24" (600 mm diagonal)	27" (676.6 mm diagonal)
Tuner type:	Quartz PLL Frequency Synthesized		
Receiving channels:	VHF 2-13 UHF 14-69 CATV 14-36 (A)-(W) 37-59 (AA)-(WW) 60-85 (AAA)-(ZZZ) 86-94 (86)-(94) 95-99 (A-5)-(A-1) 100-125 (100)-(125) 01 (5A)		
Antenna input:	VHF/UHF In 75 ohm coaxial		
Speaker:	1-13/16" (46 mm) x 3-7/8" (99 mm), 8 ohm x 2		
Audio output power:	1.5W + 1.5W		2.5W + 2.5W
VCR section			
Video head:	4 Rotary Heads		
Audio track:	Hi-Fi Sound - 2 Tracks / MONO Sound - 1 Track		
Tuner:	181 Channel Freq. Synthesized VHF 2-13 UHF 14-69 CATV 14-36 (A)-(W) 37-59 (AA)-(WW) 60-85 (AAA)-(ZZZ) 86-94 (86)-(94) 95-99 (A-5)-(A-1) 100-125 (100)-(125) 01 (5A)		
F.FWD/REW Time at 25°C (77°F):	Approx. 1minute and 48 seconds (with T-120 Cassette Tape)		
DVD section			
Signal system:	NTSC		
Applicable disc:	DVD (12cm, 8cm), CD (12cm, 8cm)		
Frequency response:	DVD: 4Hz - 22KHz/CD: 4Hz - 20KHz		
S/N Ratio:	90dB		
Harmonic distortion:	0.06%		
Wow and flutter:	Below Measurable Level		
Output:	Video : (RCA) 1 Vp-p/75 ohm Audio : (RCA) -12 dBm/1 K ohm Digital Audio : 0.5Vp-p/75 ohm		
Pickup:	CD : Wavelength: 775 - 805 nm Maximum output power: 0.5 mW DVD : Wavelength: 640 - 660 nm Maximum output power: 1.0 mW		

ACCESSORIES: Remote control x 1
Batteries (AAA) x 2

Warranty

RCA TruFlat TV/DVD/VCR Combination Limited Warranty

What your warranty covers:

- Defects in material or workmanship.

For how long after your purchase:

- One year from date of purchase for labor charges.
- One year from date of purchase for parts.
- Two years from date of purchase for picture tube.

The warranty period for rental units begins with the first rental or 45 days from date of shipment to the rental firm whichever comes first.

What we will do:

- Pay any Authorized RCA Television Service Center the labor charges to repair your unit.
- Pay any Authorized RCA Television Service Center for the new or, at our option, rebuilt replacement parts and picture tube required to repair your unit.

How you get service:

- For 20" screen size: Take your unit to any Authorized RCA Television Service Center and pickup when repairs are complete.
- For screen sizes larger than 20": Request home or pick up, repair and return service from any Authorized RCA Television Service Center, provided that your unit is located within the geographic territory covered by an Authorized RCA Television Service Center. If not, you must take your unit to the Service Center location at your own expense, or pay for the cost the Service Center may charge to transport your unit to and from your home.
- To identify your nearest Authorized RCA Service Center, ask your dealer, look in the Yellow Pages, visit www.rca.com, or call 1-800-336-1900.
- Proof of purchase in the form of a bill of sale or receipted invoice which is evidence that the product is within the warranty period must be presented to obtain warranty service. For rental firms, proof of first rental is also required.

What your warranty does *not* cover:

- Customer instruction. (Your Owner's Manual describes how to install, adjust, and operate your television. Any additional information should be obtained from your dealer.)
- Installation and related adjustments.
- Signal reception problems not caused by your unit.
- Damage from misuse or neglect.
- Cleaning of audio/video heads.
- Batteries.
- A product that has been modified or incorporated into other products or is used for institutional or other commercial purposes.
- Images burnt onto the screen.
- Acts of nature, such as but not limited to lightning damage.
- A unit purchased or serviced outside the U.S.A.

Product Registration:

Please complete the online Product Registration on www.rca.com or complete and mail the Product Registration Card packed with your unit. It will make it easier to contact you should it ever be necessary. The return of the card is not required for warranty coverage.

Limitation of Warranty:

THE WARRANTY STATED ABOVE IS THE ONLY WARRANTY APPLICABLE TO THIS PRODUCT. ALL OTHER WARRANTIES, EXPRESS OR IMPLIED (INCLUDING ALL IMPLIED WARRANTIES OF MERCHANTABILITY OR FITNESS FOR A PARTICULAR PURPOSE) ARE HEREBY DISCLAIMED. NO VERBAL OR WRITTEN INFORMATION GIVEN BY THOMSON INC., ITS AGENTS OR EMPLOYEES SHALL CREATE A WARRANTY OR IN ANY WAY INCREASE THE SCOPE OF THIS WARRANTY.

REPAIR OR REPLACEMENT AS PROVIDED UNDER THIS WARRANTY IS THE EXCLUSIVE REMEDY OF THE CONSUMER. THOMSON INC. SHALL NOT BE LIABLE FOR INCIDENTAL OR CONSEQUENTIAL DAMAGES RESULTING FROM THE USE OF THIS PRODUCT OR ARISING OUT OF ANY BREACH OF ANY EXPRESS OR IMPLIED WARRANTY ON THIS PRODUCT. THIS DISCLAIMER OF WARRANTIES AND LIMITED WARRANTY ARE GOVERNED BY THE LAWS OF THE STATE OF INDIANA. EXCEPT TO THE EXTENT PROHIBITED BY APPLICABLE LAW, ANY IMPLIED WARRANTY OF MERCHANTABILITY OR FITNESS FOR A PARTICULAR PURPOSE ON THIS PRODUCT IS LIMITED TO THE APPLICABLE WARRANTY PERIOD SET FORTH ABOVE.

How state law relates to this warranty:

Some states do not allow the exclusion nor limitation of incidental or consequential damages, or limitations on how long an implied warranty lasts, so the above limitations or exclusions may not apply to you.

This warranty gives you specific legal rights, and you also may have other rights that vary from state to state.

If you purchased your product outside the United States:

This warranty does not apply. Contact your dealer for warranty information.

Service calls which do not involve defective materials or workmanship are not covered by this warranty. Costs of such service calls are the sole responsibility of the purchaser.

Visit the RCA web site at www.rca.com

Please do not send any products to the Indianapolis address listed in this manual or on the carton. This will only add delays in service for your product.

Thomson Inc.
10330 North Meridian Street
Indianapolis, IN 46290

©2003 Thomson Inc.
Trademark(s)® Registered
Marca(s) Registrada(s)
Printed in Thailand
TOCOM 16255920



Free Manuals Download Website

<http://myh66.com>

<http://usermanuals.us>

<http://www.somanuals.com>

<http://www.4manuals.cc>

<http://www.manual-lib.com>

<http://www.404manual.com>

<http://www.luxmanual.com>

<http://aubethermostatmanual.com>

Golf course search by state

<http://golfingnear.com>

Email search by domain

<http://emailbydomain.com>

Auto manuals search

<http://auto.somanuals.com>

TV manuals search

<http://tv.somanuals.com>