



---

# RCT6672W23 7 Mercury User Manual

English (EN)



It's important to read these instructions prior to using your new product for the first time.

# Safety Precautions

EN



Equipment tested for compliance as a complete unit

## FCC Information

This device complies with Part 15 of the FCC Rules. Operation is subject to the following two conditions: (1) This device may not cause harmful interference, and (2) this device must accept any interference received, including interference that may cause undesired operation.

**Note:** This equipment has been tested and found to comply with the limits for a Class B digital device, pursuant to Part 15 of the FCC Rules. These limits are designed to provide reasonable protection against harmful interference in a residential installation. This equipment generates, uses and can radiate radio frequency energy and, if not installed and used in accordance with the instructions, may cause harmful interference to radio communications.

However, there is no guarantee that interference will not occur in a particular installation. If this equipment does cause harmful interference to radio or television reception, which can be determined by turning the equipment off and on, the user is encouraged to try to correct the interference by one or more of the following measures:

- Reorient or relocate the receiving antenna.
- Increase the separation between the equipment and receiver.

- Connect the equipment into an outlet on a circuit different from that to which the receiver is connected.
- Consult the dealer or an experienced radio/TV technician for help.

**Warning:** Changes or modifications not expressly approved by the party responsible for compliance (MLB International Inc., P.O. Box 1535, Buffalo, NY 14226, Tel: 516-236-4556) could void the user's authority to operate the equipment.

### **CAN ICES-3(B) / NMB-3(B)**

**Warning:** The AC adapter is used as disconnect device and it should remain readily operable during intended use. In order to disconnect the mains plug from mains completely, the AC adapter should be disconnected from the mains socket outlet completely.

### **Service Information**

This product should be serviced only by those specially trained in appropriate servicing techniques. For instructions on how to obtain service, refer to the warranty included in this guide.

# IMPORTANT SAFETY INSTRUCTIONS

EN

## PLEASE READ AND SAVE THIS FOR FUTURE REFERENCE

Some of the following information may not apply to your particular product; however, as with any electronic product, precautions should be observed during handling and use.

- Read these instructions.
- Keep these instructions.
- Heed all warnings.
- Follow all instructions.
- Do not use this apparatus near water.
- Clean only with dry cloth.
- Do not block any ventilation openings. Install in accordance with the manufacturer's instructions.
- Do not install near any heat sources such as radiators, heat registers, stoves, or other apparatus (including amplifiers) that produce heat.
- Protect the power cord from being walked on or pinched particularly at plugs, convenience receptacles, and the point where they exit from the apparatus.
- Only use attachments / accessories specified by the manufacturer.
- Unplug this apparatus during lightning storms or when unused for long periods of time.

- Refer all servicing to qualified service personnel. Servicing is required when the apparatus has been damaged in any way, such as power-supply cord or plug is damaged, liquid has been spilled or objects have fallen into the apparatus, the apparatus has been exposed to rain or moisture, does not operate normally, or has been dropped.

## **ADDITIONAL SAFETY INFORMATION**

- The AC adapter and apparatus shall not be exposed to dripping or splashing and no objects filled with liquids, such as vases, shall be placed on the apparatus.
- Always leave sufficient space around the product for ventilation. Do not place product in or on a bed, rug, in a bookcase or cabinet that may prevent air flow through vent openings.
- Do not place lighted candles, cigarettes, cigars, etc. on the product.
- Care should be taken so that objects do not fall into the product.
- Do not attempt to disassemble the cabinet. This product does not contain customer serviceable components.
- To prevent the risk of fire or electric shock, do not expose this apparatus to rain or moisture.
- Do not play your headset at high volume. Hearing experts warn against extended high-volume play.

# Contents

EN

<b>Safety Precautions</b> .....	<b>1-2</b>
<b>Important Safety Instructions</b> .....	<b>3-4</b>
<b>Startup</b> .....	<b>6-12</b>
Overview of Controls .....	6-7
Buttons .....	7-8
Accessory .....	8
Navigating the Home Screen .....	9-12
<b>Connections</b> .....	<b>13-18</b>
Battery Management and Charging .....	13-14
Micro-USB .....	15
Headphone .....	15
Micro SD .....	16
Wi-Fi .....	17-18
VPN .....	18
<b>Basic Operation</b> .....	<b>19-26</b>
First Time Operation .....	19
Basic Operation .....	19-21
Google Now™ .....	21
Voice Search & Voice Actions .....	22
Google Play™ .....	23
Settings .....	23-25
Google™ .....	25-26
<b>Preinstalled Apps</b> .....	<b>26</b>
<b>Additional Information</b> .....	<b>26-28</b>
Trouble Shooting .....	26-27
Specifications .....	28
Copyright and Trademark Notices .....	28
<b>Limited Warranty</b> .....	<b>29-32</b>

## Overview of Controls

Front Camera



- Rear Camera
- Power Button 
- Headphone Jack
- Microphone
- Micro-USB Port
- DC Jack
- Vol+/- Button
- Micro
- SD Card Slot

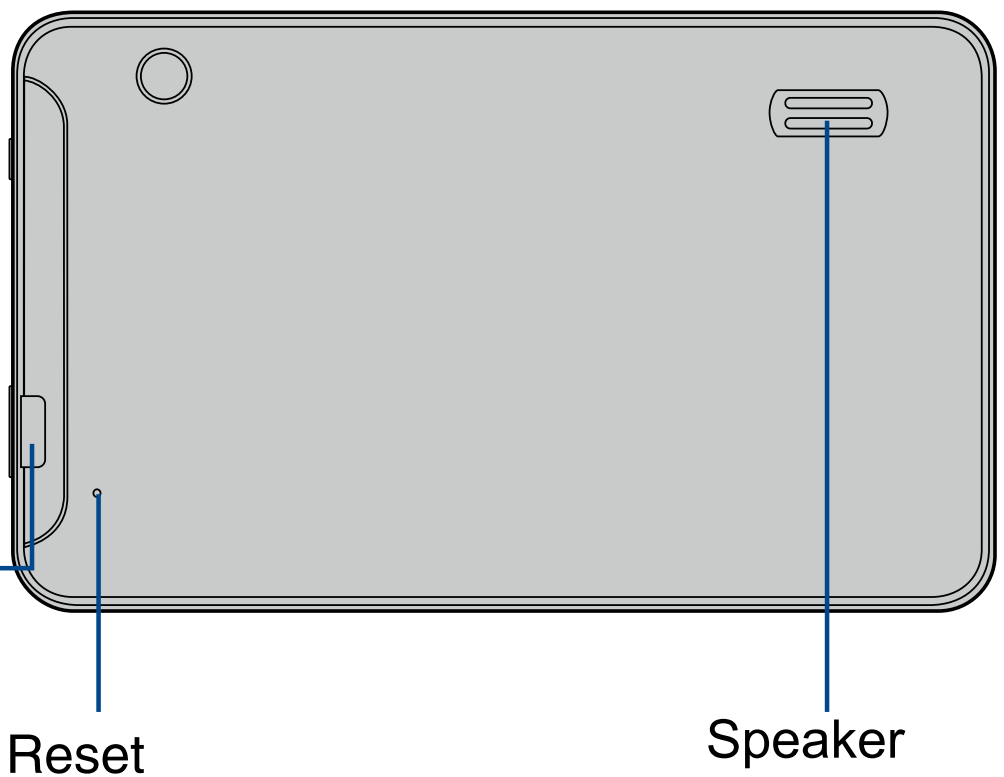

## Item

## Description

---

### Power Button

Press to enter standby/wake up mode, press and hold to switch On/Off the unit.

### Headphone Port

Headphone connection for personal listening.

### Microphone

For voice input.

### Micro-USB Port

MINI USB Port, connect to a PC or USB storage device; for charging.

### DC Jack

Connect with 5V DC charger.

### Vol+/- Key

Press to increase/decrease the volume.

### Micro SD Card Slot

Accepts micro SD card (up to 32G).

### Reset

Reset the tablet.

## Buttons

---

### Power Button

#### Power the Tablet On

Press & hold the **Power**  button until the RCA logo appears.

#### Power the Tablet Off

Press & hold the **Power**  button until a message box displays. Select "Power off". Tap "OK" and the tablet will be powered off.



## Sleep Mode

Briefly press the Power button to put the tablet in sleep mode.

If you don't operate for some time, the tablet will enter sleep mode automatically.

**Tip:** You can go to **Settings > DEVICE > Display > Sleep** to set the screen timeout.

## Wake the Tablet from Sleep Mode

Press the Power button to wake the tablet from sleep mode.

## Vol +/- Button

Press the **Vol +/-** button to increase or decrease the volume.

**Tip:** You can go to **Settings > DEVICE > Sound > Volumes** to adjust volume settings for Music, Video, Games & other media, Notifications and Alarms.

## Accessory

---

The following accessory is included.

AC Adapter ..... x1

# Navigating the Home Screen

EN

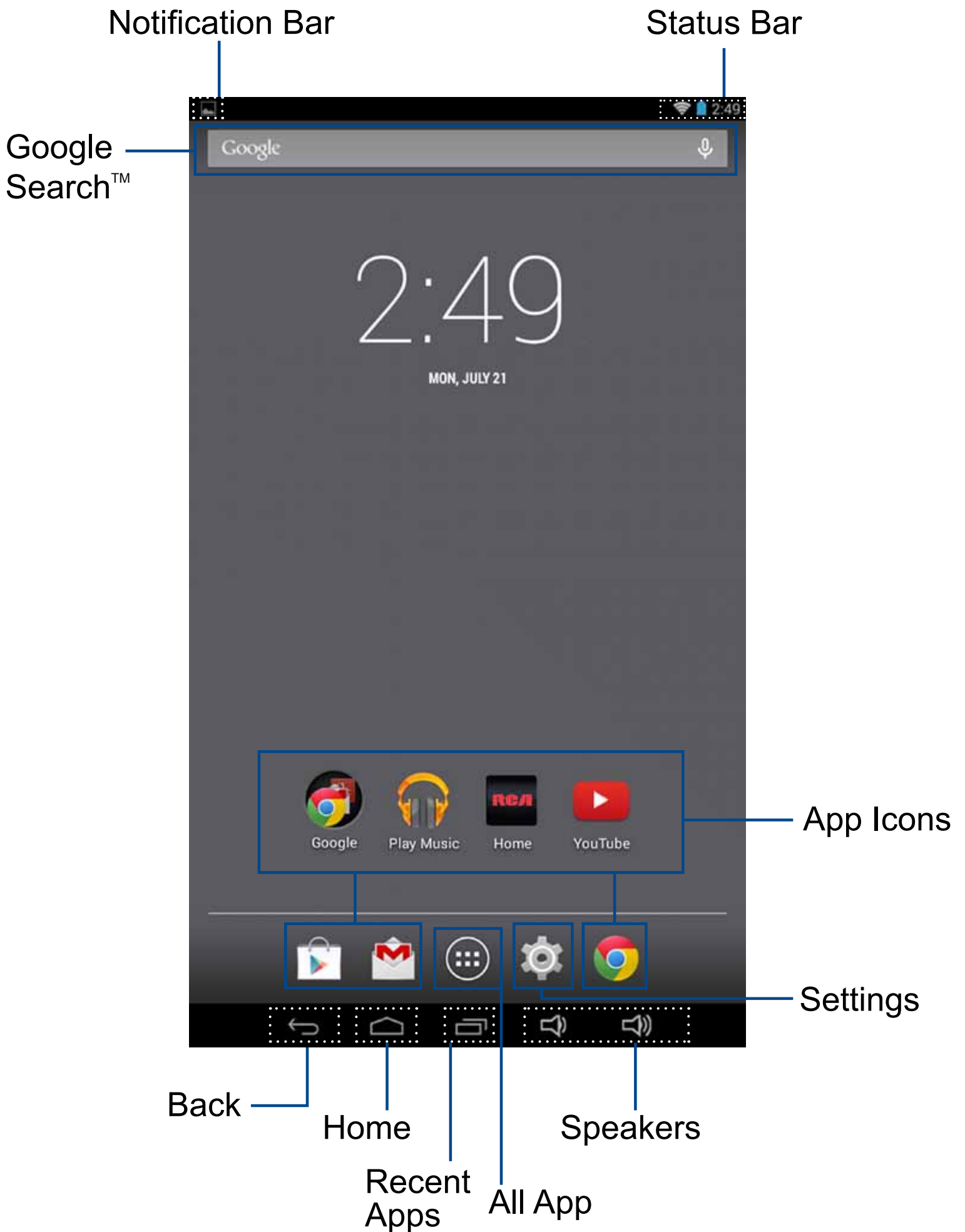

## Notification & Status Bar

Some indicators that inform you about the status of your tablet are shown at the top of the screen.

### Notification Shade

Notifications may come from the system, a game, an application such as E-mail, or the music player.

When Notifications are available, related icons will appear in the top left corner of the screen. To open the Notification Shade, touch the Notification icon and swipe your finger down. Some notifications allow you to take specific actions by tapping icons within the notification.







After you are finished with a notification, just slide it away to the left or right. If you want to dismiss all notifications, tap the Dismiss icon  at the top of the notification.

### Status Bar & Quick Settings

The Status Bar in the top right corner shows various indicators, including Wi-Fi connection and battery status. To access "Quick Settings", touch the status bar and swipe down. You can then adjust various settings on the tablet by touching the corresponding square.

## Notification & Status Icons

The below table lists some of the frequently used icons in the Notification & Status bar:

Item	Description
 Message	Received new message.
 Music	The Google Play Music app is running.
 Screenshots	Screenshot captured.
 USB tethering	Has connected to a PC and the USB tethering is turned on.
 Wi-Fi	Has a Wi-Fi Internet connection.
 Play Store	An update for an app is available.

## Home Screen Icons



All Apps 

Tap the All Apps icon  to enter the All Apps screen.

In All Apps screen, you can:

- Move between screens: Slide left or right.
- Open an App: Tap its icon.
- Copy an App icon to the Home screen: Press & hold the icon or widget icon and slowly to drag it to the Home screen.
- View widgets: Tap the widgets tab at the top of a All

Apps screen. Widgets are app information displays that can be placed on your Home screen.

- Get more apps: Tap the Google Play Store icon .
- View info about an App: Press & hold it, and drag it to the top of the screen, then drop the app over the App Info icon .

**Tip:** Most apps include a Menu icon  near the top or bottom of the screen that lets you control the app's settings.

## Back

Tap Back icon  to return to the previous screen.

- The Back icon remains on the bottom of the screen at all times, allowing you to navigate back to the previous screen.
- Once you go back to the Home screen, you can't go back any further in your history.

## Home

Tap Home icon  from anywhere on your tablet to return to the Home screen.

## Recent Apps

Tap Recent Apps icon  to view recently used apps. Tap an app to use it again.

You can slide down to see more apps. You can also slide it away to the left or right.

## Speakers &

Tap Speaker icon  to increase volume.

Tap Speaker icon  to decrease volume.

# Connections

## Battery Management and Charging

The tablet has a built-in rechargeable battery.

### Battery Icon

The battery icon in the upper-right corner shows the battery level or charging status.

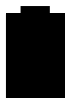

Full battery



Low battery



Need to be  
charged



Charging

### Charging the Battery

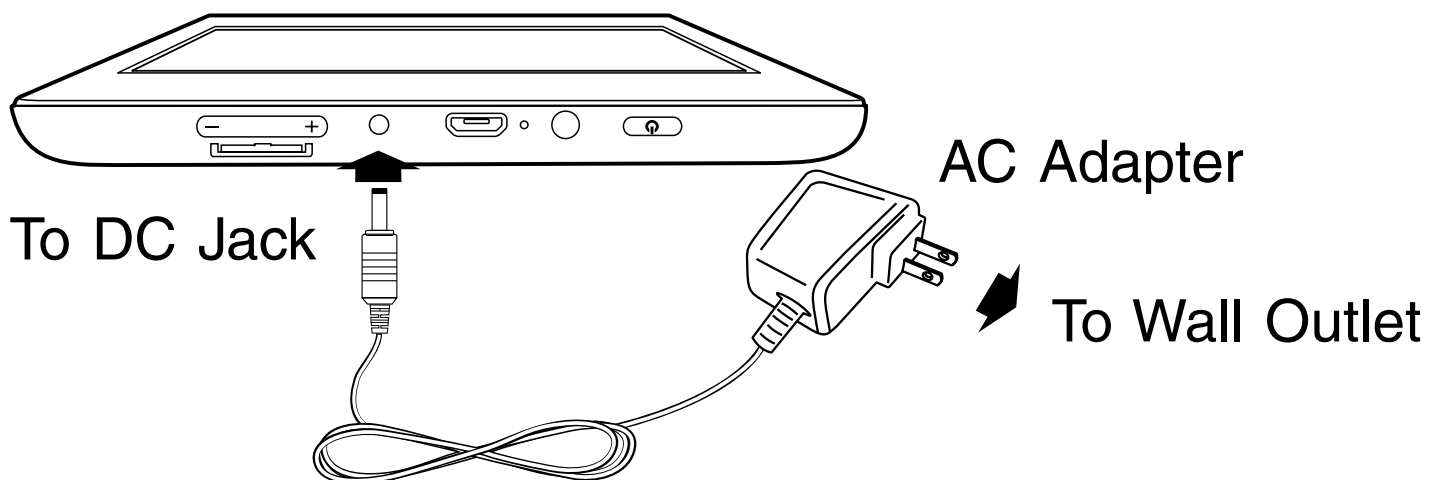

**Note:** In order to keep the battery working in best condition, please pay attention to the following:

- The included AC adapter is for use with this unit only. Do not use it with other equipment.
- Please do not charge the battery in high temperatures.
- Do not wait for the battery to be fully depleted before

charging again. Keep the battery charged as needed.

- If tablet has not been used for a long period of time, the battery might be in over discharge protection mode and may take longer to charge.

## Prolong the Battery Life

Here are some tips for how to prolong the life of the battery:

- If you aren't using Wi-Fi, go to Settings > Wireless & Networks > Wi-Fi, turn it off.
- Don't leave the Maps or Navigation apps open on the screen when you're not using them.
- Turn down screen brightness and set a shorter screen timeout: Settings > Device > Display.
- If you don't need it, turn off automatic syncing for all apps: Settings > Accounts > [Google account-name]. This means you need to sync manually to collect messages, email, and other recent information, and won't receive notifications when updates occur.

## Micro-USB

---

EN

Connect your tablet to a PC or a USB storage device with a USB cable (not included), to transfer music, pictures and other files in both directions.

**Note:** To change your tablet's USB connection options, you should go to **Settings > Device > Storage**, and tap **Menu icon**  at the upper right corner. Then tap **USB computer connection** to enter to setup.

The tablet can be connected to a keyboard, a mouse or other input devices via USB cable and use it just as you would with a PC.

## Headphone

---

Headphone can be connected to the tablet's Headphone Jack.

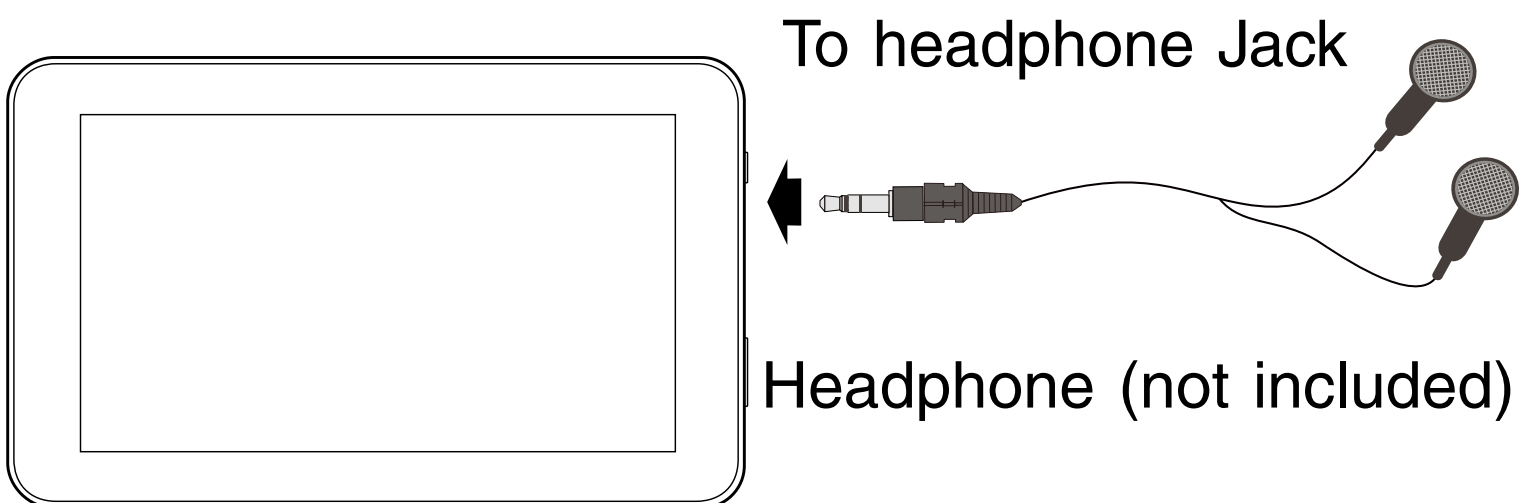



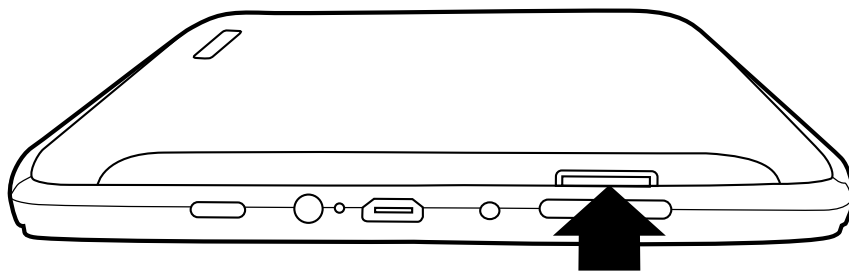

Micro SD Card  
(not included)



To Micro SD Card Slot

Insert the micro SD card, with contacts facing the screen, into the tablet's Micro SD slot until it clicks.

To check the storage of the micro SD card, go to **Settings > Device > Storage**.

Remove the micro SD card by pushing in on the card's edge. The card will pop out and can be removed.

### Notes:

- You can use microSD™ card and microSDHC™ card (up to 32GB, SD card not included).
- Never remove or insert micro SD card in On mode.

## Connect to a Wi-Fi Network

EN

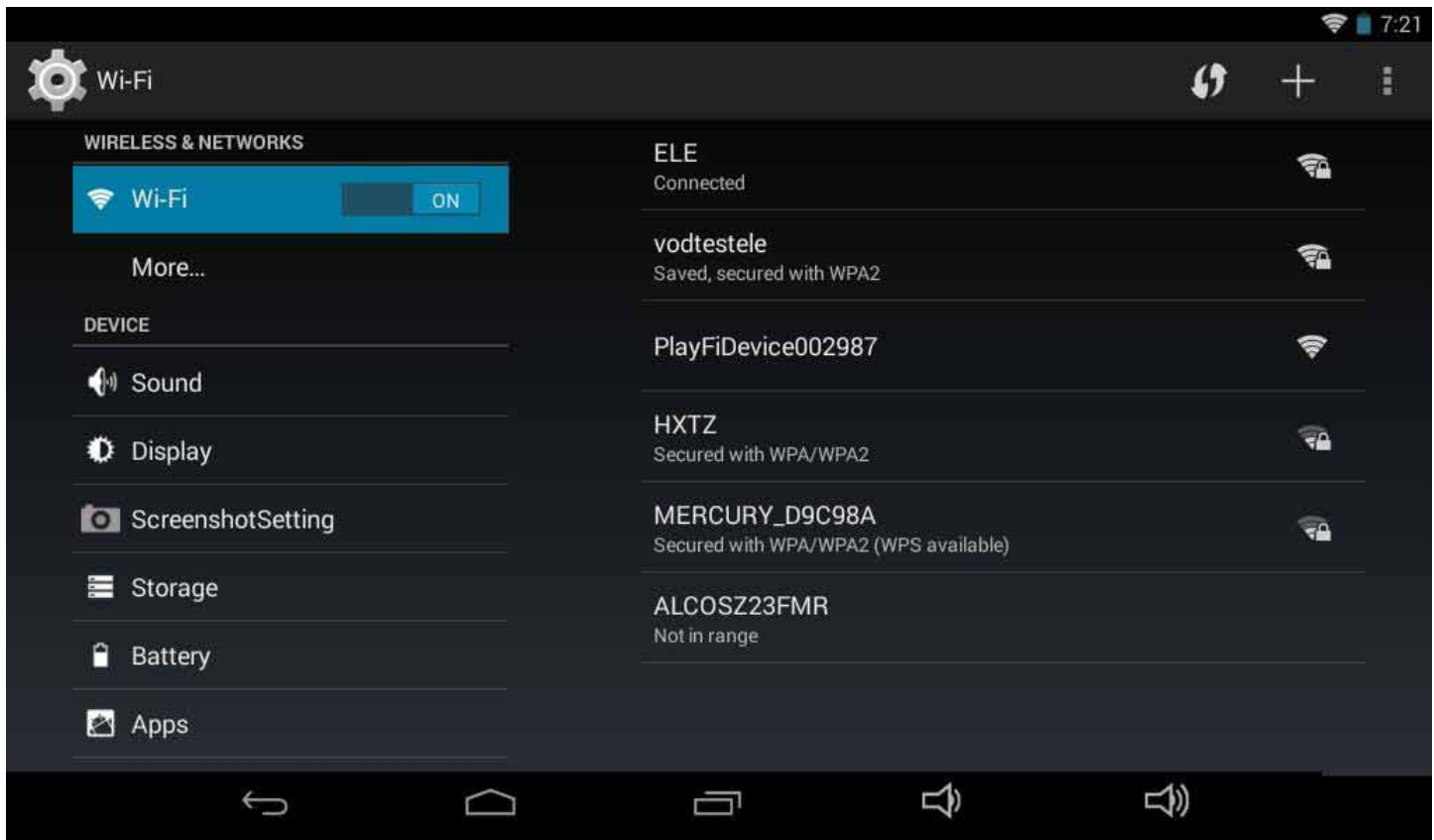

1. Go to **Settings > Wireless & networks > Wi-Fi**, and slide the Wi-Fi switch to the ON position.
2. The device will scan Wi-Fi networks automatically and display the available names.
  - If the device finds a network that you connected to previously, it will connect to it automatically.
3. Tap a network name to connect to it, and enter a password if necessary.
4. Alternatively, if your Wi-Fi router supports Wi-Fi Protected Setup, tap the WPS icon  at the top of the screen, and then press the WPS button on your router.

5. If your network does not broadcast its SSID, tap the Plus icon + at the top of the screen, and enter the Network SSID (name) of the network. If necessary, enter security or other network configuration details.

**Note:** you can tap **Menu icon**  at the upper right corner in the Settings screen for advanced settings.

## VPN (Virtual Private Network)

You can create virtual private network (VPN) and connect to your private network securely through a public network, such as the internet. You must set a lock screen PIN or password before you can use credential storage.

Add VPN network and follow the instructions on the screen.

## First Time Operation

---

EN

### Turning Your Tablet On for the First Time

When using the tablet for the first time, you will be required to setup the following:

1. Select the language, then tap  .
2. Set the Wi-Fi.
3. If you have a Google Account, select "Yes". Then tap a network name to see more details or connect to it, and enter a password if necessary.

When prompted, sign in using the email address and password for your Google Account. If you don't have one yet, go ahead and create one.

4. Follow the onscreen instructions to setup the tablet.

## Basic Operation

---

### Using the Touchscreen

Here are some basic procedures for interacting with the touchscreen.

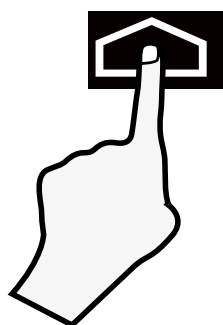

#### Tap

To select an item on the touchscreen, lightly tap it.



## Press & Hold

In some instances, touching the item and holding your finger on it will present other options or menus.

EN

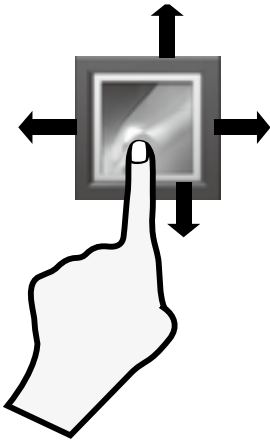

## Drag or Swipe

While holding an item such as an icon, it can sometimes be moved by dragging it to another area or screen. You may also be able to swipe your finger across a screen or item to navigate or move it.

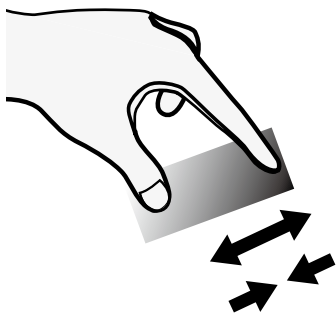

## Zoom

By placing two fingers on the screen, you can slide them apart to "Zoom In", or pinch them together to "Zoom Out".

## Customizing the Home Screen

- From All Apps screen to Home screen: Tap All Apps icon  to open All Apps screen, press & hold an icon or widget and slowly to drag it to the location of your choice. This makes it much easier to change your Home screen layout.
- Move apps or widgets: Press & hold an icon or widget, slowly to drag it to the screen edge, the screen will switch.
- Delete apps or widgets: Press & hold an icon or widget, when the "X" icon appears at the left of the screen, drag the icon or widget into it.
- Press & hold the wallpaper on your Home screen, and choose your wallpaper from Gallery, Live Wallpapers , Photos or Wallpapers.

## Google Now

---

To create a truly personalized experience, using your location and personal Google account information, use Google Now. Touch and Hold the Home icon, and slide up to the Google Now icon. Follow the instructions to setup your Google Now experience.

## Voice Search & Voice Actions

---

### Turn Voice Search or Voice Action On

You can initiate a Voice Search or Voice Action by tapping the Microphone icon in the top left corner of the Home screen.

When you're viewing the Google Now screen, you don't have to touch anything. Just say "Google."

**Note:** To detect when you say "Google" to launch Voice Search or Voice Actions, your tablet analyzes sound picked up by your tablet's microphone in intervals of a few seconds or less.

### Using Voice Search

After tapping the microphone icon, just say whatever it is you want Google to search for.

### Using Voice Actions

There are many actions that the tablet can perform using "Voice Actions". For example, you can send emails, set alarms, play a song, or navigate to a website. Just tap the Microphone icon, and say what you want the tablet to do. As you speak, Voice Search analyzes your speech and initiates the action.

If Voice Search doesn't understand you, it lists a set of possible meanings. Just tap the one you want.

## Google Play

---

EN In addition to the apps that come preinstalled on your tablet, you can download Android™ apps and games, music, movies, TV shows, and magazines on Google Play.

1. On the App menu, touch the Google Play Store icon.
2. To search for an item from the Google Play Store app, touch the search icon in the upper right corner, and then type a keyword to search.
3. Touch an available item to go to its details page. From there you can install or download the item.

## Settings

---

Settings lets you configure the tablet, set app options, add accounts, and change other preferences.

### WIRELESS & NETWORKS

**Wi-Fi**—Enable or disable Wi-Fi, and connect to a wireless network so that you can check email, search the Web, or access social media websites.

**More...** —Enable or disable Airplane mode or VPN.

### DEVICE

**Sound**—Set **Volumes**, **Default notification sound**, and enable or disable **Touch sounds** and **Screen lock sound**.

**Display**—Set **Brightness**, **Wallpaper**, **Sleep**, **Daydream**, **Font size**, **Cast screen** and **Full screen mode**.



**ScreenshotSetting**—Set **Select delay time to capture the screen**, **Set the location of screenshot storage** and enable or disable **Show the screenshot button in the statusbar**.

**Storage**—View available space in **INTERNAL STORAGE**, **SD CARD** and **USB STORAGE** /set the related items.

**Battery**—View battery status.

**Apps**—View downloaded apps and running apps. To view information or uninstall an app, tap the relevant app.

**User**—Set users & Profiles

## PERSONAL

**Location** —Enable or disable Mode ,**RECENT LOCATION REQUESTS** and **LOCATION SERVICES**.

**Security**—Set preferences for **SCREEN SECURITY**, **ENCRYPTION,PASSWORDS**, **DEVICE ADMINISTRATION**, **CREDENTIAL STORAGE** and **USER Experience Program**.

**Language & input**—Set preferences for **Language**, **KEYBOARD & INPUT METHODS**, **SPEECH** and **MOUSE/TRACKPAD**.

**Backup & reset**—Set preferences for **BACKUP & RESTORE**, and **PERSONAL DATA**.

## ACCOUNTS

You can add an email account or another type of account.

## SYSTEM

**Date & time**—Enable or disable **Automatic date & time**, and select preferences for date, time, time zone, time format, and date format.

**Accessibility**—Select preferences for **SERVICES** and **SYSTEM**.

**Printing** — Enable or disable **PRINT SERVICES**.

### About tablet

Check System updates, Status, Legal information etc.

## Google

---

A Google Account lets you organize and access your personal information from any computer or mobile device.

### Add an Account

You can use multiple Google Accounts and Microsoft Exchange ActiveSync accounts on your tablet.

You may also be able to add other kinds of accounts, depending on your apps. To add some accounts, you may need to obtain details from your system administrator about the service to which the account connects. For example, you may need to know the account's domain or server address.

1. Go to **Settings > ACCOUNTS > Add account**.
2. Tap the kind of account to add. And then follow the on-screen instructions.

## Remove an Account

To remove a Google account, go to

**Settings > ACCOUNTS > Google > [account- name]  
Menu icon ≡ > Remove account.**

EN

## Preinstalled Apps

Your tablet comes with many apps preinstalled to allow you to browse the web, send and receive email, and access entertainment. Spend some time exploring these apps to learn how your tablet can be most useful for you.

## Additional Information

### Trouble Shooting

---

#### Tablet displays network or service error message

- When you are located in places with poor signals, your tablet may lose its Wi-Fi connection. Try moving closer to the Wi-Fi router.

#### Touch screen response is slow or incorrect

If the tablet's touch screen response is incorrect, please try the following:

- Remove any protective film of the touch screen. The protective film may prevent the device recognition input.
- Make sure that your fingers dry and clean before you tap the touch screen.
- Restart the tablet to clear any temporary software bugs.

## Tablet is frozen or a serious error appears

- If the tablet is frozen or suspended, you may need to close the app program or reset the tablet.
- If the tablet is frozen or slow to respond, press & hold the power button for 8 seconds to reset the tablet.
- If that doesn't work, insert a paper clip into the RESET hole on the back of the tablet.

## Tablet gets warm

- When using for a long time, the tablet may be warm. This is normal and will not affect the life or performance of the unit.

## Tablet can not show video of opposite side during skype call

- The Wi-Fi signal is poor. Please move close to your wireless router, or disconnect other devices from your wireless router, or increase bandwidth of internet connection.
- Please check the Wi-Fi setting. It's recommended to use an IEEE 802.11 b/g/n certified Wi-Fi network.

## Specifications

---

Power: DC IN 5V (operate with AC adapter)

Front camera: 0.3 Megapixe, rear camera: 2.0 Megapixe

EN

## Copyright and Trademark Notices

---

Android, Google, Google Play and other marks are trademarks of Google Inc.

The Wi-Fi CERTIFIED Logo is a certification mark of the Wi-Fi Alliance. The Wi-Fi Protected Setup Mark is a mark of the Wi-Fi Alliance.

Specifications subject to change without notice.

# Limited Warranty

**AVC MULTIMEDIA (“AVC”)** makes the following limited warranty. This limited warranty extend to the original consumer purchaser and is limited to non-commercial use of the product.

## One Year Parts & Labor Warranty

**AVC** products purchased in the United States or Canada are warranted to be free from defects in materials or workmanship for a period of one year from the date of their original retail purchase. If the unit fails to conform to this warranty, we will service the product using new or refurbished parts and products, at **AVC**'s sole discretion.

During a period of one year from the effective warranty date, **AVC** will provide, when needed, service labor to repair a manufacturing defect at its designated Service Center. To obtain warranty service in the United States or Canada, you must first call our **Customer Support Center at 1-877-252-6873 or 1-855-475-9646, during the hours listed in the box below.** The determination of service will be made by **AVC** Customer Support. **PLEASE DO NOT RETURN YOUR UNIT TO AVC WITHOUT PRIOR AUTHORIZATION.** New or remanufactured replacements for defective parts or products will be used for repairs by **AVC** at its designated Service Center for one year from the effective warranty date. Such replacement parts or products are warranted for an additional one year from the date of repair or replacement. The Customer will be required to ship the unit to the Service Center indicated at the time Customer Support is contacted to make the necessary repairs. The customer is responsible for all transportation charges to the service facility.

## Packaging and Shipping Instruction

When you send the product to the **AVC** service facility you must use the original carton box and packing material or an equivalent as designated by **AVC**.

### Your Responsibility

- (1) You must retain the original sale receipt to provide proof of purchase.
- (2) These warranties are effective only if the product is purchased and operated in the United States or Canada.
- (3) Warranties extend only to defects in material or workmanship, and do not extend to any product or parts which have been lost or discarded, or damage to product or parts caused by misuse, accident, improper operation or maintenance, or use in violation of instructions provided with the product, or to product which has been altered or modified without authorization of **AVC**, or to products or parts thereof which have had the serial number removed or changed.

### Out of Warranty

In the event your product requires repair after the limited warranty period has expired, please contact our Customer Support Center at

**1-877-252-6873 or 1-855-475-9646 or  
[www.RCAtablets.com](http://www.RCAtablets.com)**

**Hours: Monday–Thursday: 9am–7pm,  
Friday: 9am–5pm, Saturday: 9am–NOON Eastern  
time.**

**Important:** You are responsible for any transportation, shipping or insurance relative to the return of product to our Product Returns Center.



All warranties implied by state law, including the implied warranties of merchantability and fitness for a particular purpose, are expressly limited to the duration of the limited warranties set forth above. With the exception of any warranties implied by state law as hereby limited, the foregoing warranty is exclusive and in lieu of all other warranties, guarantees, agreements and similar obligations of manufacturer or seller with respect to the repair or replacement of any parts. In no event shall **AVC** be liable for consequential or incidental damages.

No person, agent, distributor, dealer or company is authorized to change, modify or extend the terms of these warranties in any manner whatsoever. The time within action must be commenced to enforce any obligation of **AVC** arising under the warranty or under any statute, or law of the United States or Canada or any state thereof, is hereby limited to one year from the date of purchase. This limitation does not apply to implied warranties arising under state law.

This warranty gives you specific legal rights and you may also have other rights, which may vary, from state to state. Some states do not allow limitation on how long an implied warranty lasts, when an action may be brought, or the exclusion or limitation of incidental or consequential damages, so the above provisions may not apply to you. For more information on other products and services, please visit our web site at :



**www.RCAtablets.com**

**Important:** Also keep your “Bill of Sale” as proof of purchase.

EN

FOR SUPPORT, SERVICE AND REPAIR, PLEASE VISIT  
**www.RCAtablets.com**

Specifications and external appearance are subject to change without notice.

© 2014 AVC MULTIMEDIA

## Free Manuals Download Website

<http://myh66.com>

<http://usermanuals.us>

<http://www.somanuals.com>

<http://www.4manuals.cc>

<http://www.manual-lib.com>

<http://www.404manual.com>

<http://www.luxmanual.com>

<http://aubethermostatmanual.com>

Golf course search by state

<http://golfingnear.com>

Email search by domain

<http://emailbydomain.com>

Auto manuals search

<http://auto.somanuals.com>

TV manuals search

<http://tv.somanuals.com>