

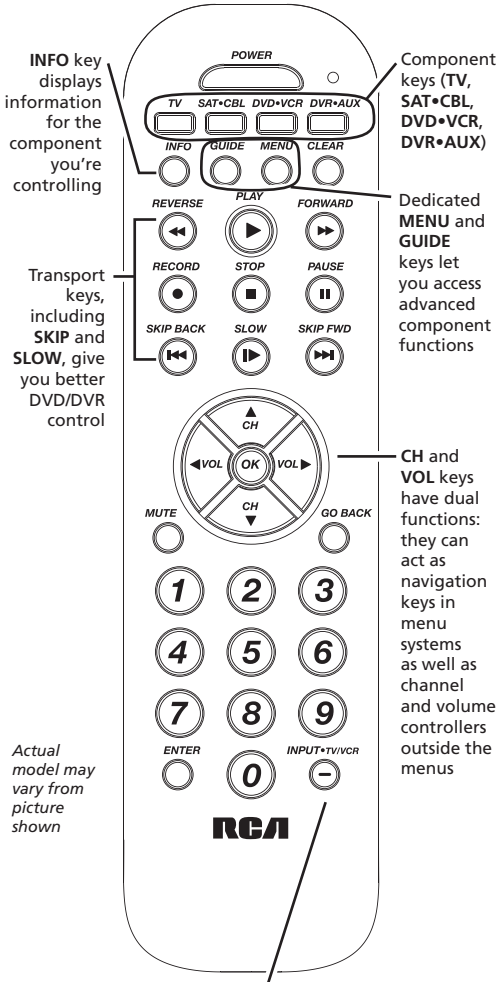

# RCR4273 / RCR4373

## Universal Remote Control Owner's Manual

### Manual del Propietario (parte posterior)



The **INPUT** and **— (dash)** key has three functions: (1) it toggles through all the video sources connected to your TV; (2) when the remote is in VCR mode, this button toggles between VCR and the TV input; (3) when you're entering digital channel numbers directly, this button lets you separate the main channel number from the subchannel number

### Care and Maintenance

- Keep the remote dry. If it gets wet, wipe it dry immediately.
- Use and store the remote only in normal temperature environments.
- Handle the remote gently and carefully. Don't drop it.
- Keep the remote away from dust and dirt.
- Wipe the remote with a damp cloth occasionally to keep it looking new.
- Modifying or tampering with the remote's internal components can cause malfunction and invalidate its warranty.

## Four-Component Universal Remote

Congratulations on your purchase of this four-component universal remote. This universal remote controls up to four electronic components and makes juggling remote controls a thing of the past. Your remote is guaranteed to work with all brands of components. This remote is unusually versatile because it has a **DVR•AUX** key that you can program to control any video component. The four-component universal remote is easy to use, easy to program and gives you control at the touch of your fingertips.

### SAVE THIS MANUAL AND THE CODE LISTS!

*Remote controls can sometimes lose their programming when you change the batteries. Make sure you keep the manual and code lists in a safe place so that you can reprogram the remote if you need to.*

**Tip:** The four-component universal remote is already programmed to operate most **RCA, GE** and **PROSCAN** branded TVs, **VCRs, DVD players** and **satellite receivers**. Just press the corresponding key—**DVD•VCR** for a DVD player, **TV** for a television, **SAT•CBL** for a satellite receiver, **DVR•AUX** for a DVR.

## Battery Installation and Information

Your universal remote requires two AAA Alkaline batteries (batteries may or may not be included, depending on model).

### To install the batteries:

1. Remove the battery compartment cover.
2. Insert the batteries, matching the batteries to the (+) and (-) marks inside the battery compartment.
3. Push the battery cover back into place.

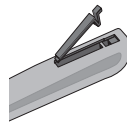

**Note:** If you are replacing batteries, try not to press any buttons after you've taken the old batteries out. Pressing buttons while replacing batteries causes the remote to lose the devices you've programmed. You will need to program the remote again.

### Battery Precautions:

- Do not mix old and new batteries.
- Do not mix alkaline, standard (carbon-zinc) or rechargeable (nickel-cadmium) batteries.
- Always remove old, weak or worn-out batteries promptly and recycle or dispose of them in accordance with Local and National Regulations.

## Battery Saver

Your universal remote control saves battery power by automatically turning off if any key is pressed for more than 60 seconds. This saves your battery life should your remote get stuck in a place where the keys remain depressed, such as between sofa cushions.

## Programming Your Remote

Your universal remote can operate a variety of brands of components. In order for your universal remote to control your components, you need to program the remote with the codes that match the components (See Code Lists enclosed or go to [rca.com/codefinder](http://rca.com/codefinder)). These codes enable the remote to communicate with your components. Each brand and each component has its own "language," and, by programming the correct codes into your remote, you tell the remote to "speak the same language" as your components.

## The RCA Easy Interactive Code Finder

The online interactive code finder at [www.rca.com/codefinder](http://www.rca.com/codefinder) makes it easier to find exactly the right codes for your components. The code finder takes you right to the best code(s) for your component—no need to go through long code lists!

There are four methods you can use to program your remote control to operate your components:

- Brand Code Search and Entry
- Direct Code Entry
- Manual Code Search and Entry
- Auto Code Search and Entry

Most components can be programmed in one of these four ways. Try them in the order listed.

In order to control combo TV/VCR or TV/DVD units, you must program both the TV key and the DVD•VCR key. Once programmed successfully, the TV key controls the TV functions on your unit, and the DVD•VCR key controls the DVD or VCR functions. There is a specific section in the Code Lists for combo units. The codes in this section should be tried first, using Direct Code Entry on the TV and DVD•VCR keys. If this is unsuccessful, follow the normal programming methods for both the TV and the DVD•VCR keys.

### DVD•VCR Key

**Important:** The DVD•VCR key defaults to program a DVD player. If you want the DVD•VCR key to control a VCR, you must preprogram the DVD•VCR key. See the section entitled “Programming the DVD•VCR Key To Control a VCR” on page 3.

### DVR•AUX Key

**Important:** The DVR•AUX key defaults to program a DVR. If you want the DVR•AUX key to control a component other than a DVR (an additional TV or DVD, for example), you must preprogram the DVR•AUX key. See the section entitled “Programming the DVR•AUX Key To Control Other Components” on page 4.

## Brand Code Search and Entry

If your brand is listed in the Brand Code List (See Code Lists enclosed), you may be able to program your universal remote by searching through only the Code Lists for that specific manufacturer. Brand Code Search and Entry can be the quickest method to program your remote, if your component is one of those brands listed.

If your brand is not listed in the Brand Code List, use one of the other programming methods that follow.

Follow these instructions to program your remote using the Brand Code Search and Entry method.

**CLEAR** **TIP:** To exit without saving at any point in the Brand Code Search, press and release the CLEAR key.



1. Manually turn on the component you want the remote to control (TV, VCR, DVD, DVR, satellite receiver, or cable box).
2. Locate the Brand Codes in the Code Lists and keep it handy.

**Note:** If you press an invalid key during the Brand Code Search, the remote does not respond. If you do not press a valid Brand Code Search key (TV, SAT•CBL, DVD•VCR, DVR•AUX, POWER, CLEAR, and number keys 0-9), the search times out after two minutes. When the search times out, the LED blinks four times and turns off. The last programmed code under that component key is retained.

### Notes:

- To program the DVD•VCR key to control a VCR, see page 3.
- To program the DVR•AUX key to control a component other than a DVR, see page 4.

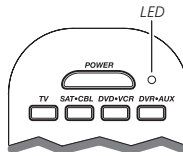

3. Press and hold the component key (TV, SAT•CBL, DVD•VCR, DVR•AUX) you wish to program. The LED turns on and remains on. Keep holding down the component key.

4. While holding the component key down, press and hold the POWER key. The LED turns off. After holding both keys down for three seconds, the LED turns back on.
5. Release both keys. The LED remains on.
6. Refer to the Brand Codes in the enclosed Code Lists. Use the number keys to enter the number for your brand. The LED blinks once.  
**TIP:** Throughout the programming of each key, be sure to keep the remote pointed at the IR sensor of the component you are currently programming the remote to control.
7. Press and release the POWER key repeatedly until your component turns off. Each time you press the POWER key, the LED blinks and the next code is sent. The Brand Code Search begins with the first code in the chosen brand list for that component and cycles through all the codes for that brand.

If your component turns off, you have found the correct code. If the remote cycles through and the LED blinks four times and turns off, all codes in the chosen brand lists have been searched and another programming method should be tried. The Brand Code Search mode is exited.



8. Once you have found the correct code, you must save that code by pressing and releasing the STOP key. The LED turns off.

**IMPORTANT:** You must press the STOP key to save the code or the correct code will not be stored!

## Testing the Code for Maximum Functionality

Different remote control codes can provide different levels of functionality. To confirm that the component key is programmed with the correct code for maximum functionality, follow the steps below.

1. Attempt to control a variety of the component's functions with the remote. If some features of your components do not work, go to step 2 to try a different code.
2. Repeat the Brand Code Search and Entry Method from step 1. When the component turns off for the first time, do not press the STOP key, which would store the code. Instead, with the unit now off, continue to press the POWER key repeatedly until the unit turns back on.
3. Once the unit turns back on, you have found another code that operates the component. Press the STOP key.
4. Test the key's functionality again by attempting to control a variety of the component's functions. If the code that has been stored controls the majority of the component's functions, programming is complete. If the code stored does not give maximum functionality, try another code.
5. Repeat the Brand Code Search and Entry Method from step 1. Each time a code turns the component on or off, you have found a code that operates the component and needs to be tested for maximum functionality. Continue through the code lists, cycling through the codes you have already tried, until you find one that offers maximum functionality.

## Direct Code Entry

To use the direct code entry method to program your universal remote to control your components, follow the steps below.

1. Manually turn on the component you want the remote to control (TV, VCR, DVD, DVR, satellite receiver, or cable box).
2. Locate the enclosed Code Lists. Find the list for the component you wish to program. Find your component's brand. You will see a listing of four-digit codes for each brand. If your brand isn't listed, use one of the Code Search methods to program the remote control. (Refer to pages 3–8 for Manual and Auto Code Search methods.)

**Note:** You can also use the online code finder at [www.rca.com/codefinder](http://www.rca.com/codefinder) to find the best code for your component.

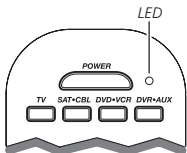

3. Press and hold the component key (TV, SAT•CBL, DVD•VCR, DVR•AUX) you wish to program. The LED turns on and remains on.

Keep holding down the component key. If you release the component key any time during the Direct

Code Entry procedure, the LED blinks four times, and the process is exited. The last programmed code under the component key is retained.

### Notes:

- To program the DVD•VCR key to control a VCR, see below.
- To program the DVR•AUX key to control a component other than a DVR, see page 4.

4. While holding down the component key, consult the Code Lists for the four-digit code that corresponds to your component's brand and use the number keys (0-9) to enter it. After you press the first number, the LED turns off. After the fourth number is entered, the LED turns on.

**TIP:** Throughout the programming of each key, be sure to keep the remote pointed at the IR sensor of the component you are currently programming the remote to control.

5. Release the component key. If the LED turns off, you have entered a valid code and have followed the correct procedure for Direct Code Entry. Proceed to the next step. If the LED blinks four times, you have either entered a code number that is not in the code lists or missed a step in the code entry procedure. Repeat the Direct Code Entry process from step 3 and try the next code listed.
6. To confirm that the component key is programmed with the correct code for maximum functionality, test the component. Attempt to control a variety of the component's functions with the remote. If some features of your components do not work, try programming the remote with a different code in the list until you find the code that allows the remote to control the majority of your component's functions. Different codes can provide different levels of functionality.

**IMPORTANT:** Remember to enter the code for future reference in the box provided in the Code Retrieval section of this manual. (See page 5.)

## Manual Code Search and Entry

If your component's brand isn't listed in the Code Lists, or if you have tried all of the codes for your brand and the remote does not operate your component, try one of the Code Search methods below—Manual Code Search or Auto Code Search. Both Code Search methods cycle through all of the codes in the Code Lists in the event that your component's code is listed under another brand.

**Note:** The Manual Code Search method may take a long time because the remote searches through all of the codes in its memory for the code that operates your component. Therefore, if your brand is listed in the Brand Codes or the Code Lists, first try the Brand Code Search or the Direct Code Entry method described on the left.

### CLEAR



**TIP:** To exit without saving at any point in the Manual Code Search, press and release the CLEAR key.

1. Manually turn on the component you want the remote to control (TV, VCR, DVD, DVR, satellite receiver, or cable box).

### Notes:

- To program the DVD•VCR key to control a VCR, see page 3.
- To program the DVR•AUX key to control a component other than a DVR, see page 4.

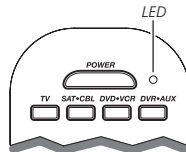

2. Press and hold the component key (TV, SAT•CBL, DVD•VCR, DVR•AUX) you wish to program. The LED turns on and remains on. Keep holding down the component key.

3. While holding the component key down, press and hold the POWER key. The LED turns off. After holding down both keys for three seconds, the LED turns back on.
4. Release both keys. The LED remains on.

**Note:** If you press an invalid key during Manual Code Search, the remote does not respond and the search times out after two minutes. When the search times out, the LED blinks four times and turns off. The last programmed code under that component key is retained.

**TIP:** Throughout the programming of each key, be sure to keep the remote pointed at the IR sensor of the component you are currently programming the remote to control.

5. Press and release the POWER key repeatedly until your component turns off. Each time you press the POWER key, the LED blinks, and the next code in the list is sent. This process continues until all of the codes in the Code Lists have been tried. If your component turns off, you have found the correct code. (If it cycles through and the LED blinks four times and turns off, all codes have been searched. The Manual Code Search method is exited.)

**TIP:** Because there are so many codes, you may have to press the POWER key many times—possibly hundreds of times.

### STOP



6. Once you have found the correct code, you must save the new code by pressing and releasing the STOP key. The LED turns off. You must press the STOP key to save the code or the correct code will not be stored! When you press the STOP key, the code is stored.
7. Be sure to retrieve the code your remote programmed by finishing the Code Retrieval process found on page 5.

### Programming the DVD•VCR Key to Control a VCR

The DVD•VCR key defaults to control a DVD player. If you want the DVD•VCR key to control a VCR, you must preprogram the DVD•VCR key.

1. Press and hold the DVD•VCR key. The LED turns on. Keep holding down the DVD•VCR key.
2. While holding down the DVD•VCR key, press and release the number 2 key on the keypad. The LED turns off.
3. Release the DVD•VCR key. The LED blinks four times and then turns off. The DVD•VCR key is now "set" to control a VCR.
4. Next, program the DVD•VCR key to control the brand of VCR you have. Remember to consult the VCR code list.

## Testing the Code for Maximum Functionality

Different remote control codes can provide different levels of functionality. To confirm that the component key is programmed with the correct code for maximum functionality, follow the steps below.

1. Attempt to control a variety of the component's functions with the remote. If some features of your components do not work, go to step 2 to try a different code.
2. Repeat the Manual Code Search and Entry Method from step 1. When the component turns off for the first time, do not press the STOP key, which would store the code. Instead, with the unit now off, continue to press the POWER key repeatedly until the unit turns back on.
3. Once the unit turns back on, you have found another code that operates the component. Press the STOP key.
4. Test the key's functionality again by attempting to control a variety of the component's functions. If the code that has been stored controls the majority of the component's functions, programming is complete. If the code stored does not give maximum functionality, try another code.
5. Repeat the Manual Code Search and Entry Method from step 1. Each time a code turns the component on or off, you have found a code that operates the remote and needs to be tested for maximum functionality. Continue through the code lists, cycling through the codes you have already tried, until you find one that offers maximum functionality.

## Auto Code Search and Entry

The Auto Code Search and Entry Method enables the remote to automatically search through all the codes in the Code Lists for the one that operates your component.

**Note:** The Auto Code Search method may take a long time because the remote searches through all of the codes in its memory for the code that operates your component. Therefore, if your brand is listed in the Brand Codes or the Code Lists, first try the Brand Code Search or the Direct Code Entry method described on pages 2–3.

**CLEAR** **TIP:** To exit without saving at any point in the Auto Code Search, press and release the CLEAR key.

1. Manually turn on the component you want the remote to control (TV, VCR, DVD, DVR, satellite receiver, or cable box).

### Notes:

- To program the DVD•VCR key to control a VCR, see page 3.
- To program the DVR•AUX key to control a component other than a DVR, see below.

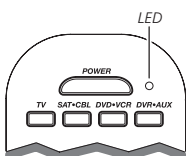

2. Press and hold the component key (TV, SAT•CBL, DVD•VCR, DVR•AUX) you wish to program. The LED turns on and remains on. Keep holding down the component key.

3. While holding the component key down, press and hold the POWER key. The LED turns off. After holding down both keys for three seconds, the LED turns back on.
4. Release both keys. The LED remains on.

**Note:** If you press an invalid key during Auto Code Search, the remote does not respond and the search times out after two minutes. When the search times out, the LED blinks four times and turns off. The last programmed code under that component key is retained.

**TIP:** Throughout the programming of each key, be sure to keep the remote pointed at the IR sensor of the component you are currently programming the remote to control.



5. Press and release the PLAY key, then wait five seconds to see if your component turns off. If your component does not respond, continue to press the PLAY key every five seconds until your component turns off.

Each time you press the PLAY key, the LED blinks several times and a block of 10 codes are sent to your component. This process continues until all of the codes in the Code Lists have been searched. If your component has not turned off after all codes have been searched, the LED blinks four times and turns off. The Auto Code Search Entry method is exited.



6. When your component turns off, you know the correct code is in the last block of 10 codes sent. Press and release the REVERSE key. Wait two seconds to see if your component turns on again.

If your component does not respond, continue to press the REVERSE key every two seconds until your component turns on again. This will isolate the correct code in the last block of codes sent. Each time the REVERSE key is pressed, the LED blinks.

**Note:** If you accidentally press the REVERSE key after your component responds, press and release the FORWARD key. Then, wait two seconds to see if your component turns off again.



7. Once your component turns on, you have found the correct code. You must save the new code by pressing and releasing the STOP key. The LED turns off. When you press the STOP key, the code is stored.

**IMPORTANT:** You must press the STOP key to save the code or the correct code will not be stored!

8. To confirm that the component key is programmed with the correct code for maximum functionality, it is necessary to test the component. If some of the features of your component do not work, different codes in the list can be tried until you find the code that allows the remote to control the majority of your component's functions. See the section entitled "Testing the Code for Maximum Functionality" on the next page for more information.

## Programming the DVR•AUX Key To Control Other Components

The DVR•AUX key defaults to control a DVR. If you want the DVR•AUX key to control a different component (an additional TV, DVD, satellite or cable box, for example), you must preprogram the DVR•AUX key.

### DVR•AUX KEY CONTROLS:

Additional TV	press 1
VCR or DVR	press 2
Additional DVD	press 3
Additional satellite or cable box	press 5

4. Next, program the DVR•AUX key to control the brand of component you have. Remember to consult the appropriate component code list. For instance, if you have programmed the DVR•AUX key to control an additional DVD, consult the DVD Code List. Program the key to control your component with the Code List enclosed.



## Testing the Code for Maximum Functionality

Different remote control codes can provide different levels of functionality. To confirm that the component key is programmed with the correct code for maximum functionality, follow the steps below.

1. Attempt to control a variety of the component's functions with the remote. If some features of your components do not work, go to step 2 to try a different code.
2. Repeat the Auto Code Search Method from step 1. When you've found the code that turns your component back on, do not press the STOP key, which would store the code. Instead, with the unit now on, continue to press the REVERSE key repeatedly until the unit turns back off.

**Note:** If you cannot find another code in this block that works, press the PLAY button to continue searching through the code blocks. When the component turns off again, press the REVERSE key to find the code in that block that makes your component turn back on.

3. Once the unit turns back on, you have found another code that operates the component. Press the STOP key.
4. Test the key's functionality again by attempting to control a variety of the component's functions. If the code that has been stored controls the majority of the component's functions, programming is complete. If the code stored does not give maximum functionality, try another code.
5. Repeat the Auto Code Search Method from step 1. Each time a code turns the component on or off, you have found a code that operates the remote and needs to be tested for maximum functionality. Continue through the code lists, cycling through the codes you have already tried, until you find one that offers maximum functionality.

## Code Retrieval

Once you've programmed the remote to control your components, you may want to record the codes for future reference. If you used the Direct Code Entry method, this is easy. Just find the codes you entered and make a note of them in the boxes below. If you used one of the Code Search methods to program your remote or if you used the Direct Entry method but don't remember the code, you will need to retrieve each component's four-digit code. Retrieving the actual code and writing it down will save you time if you ever need to program the remote again (e.g., if programming is lost when you change the batteries). If the codes are recorded, you can use the Direct Entry method to reprogram your remote to control your components, which is quick and easy.

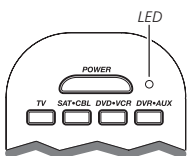

1. Press and hold the component key (TV, SAT•CBL, DVD•VCR, DVR•AUX) whose code you wish to retrieve. The LED turns on. Keep pressing the component key.

2. While holding the component key down, press and hold the INFO key. The LED turns off. After holding down both keys for three seconds, the LED turns back on.
3. Release both keys. The LED remains on.
4. Starting with the number 1 key, press and release each number key on the keypad in the following order (1-9, then 0). The number that causes the LED to blink is the first number of the code. As you find each number of the code, write it down for future reference.

**Note:** All TV codes begin with the number 1; all VCR and DVR codes begin with the number 2; all DVDs, the number 3; and all satellite receivers and cable boxes, the number 5.

5. Repeat step 4 until you have retrieved all four numbers in the code. After the fourth number is retrieved, the LED blinks briefly, then turns off.

### CLEAR



**TIP:** To exit the Code Retrieval Mode, press and release the CLEAR key at any time.

**Note:** If you press an invalid key during the Code Retrieval process, the remote will not respond. If you do not press a valid Code Retrieval key (TV, SAT•CBL, DVD•VCR, DVR•AUX, INFO, CLEAR), Code Retrieval times out after 15 seconds. The LED blinks four times, and then turns off.

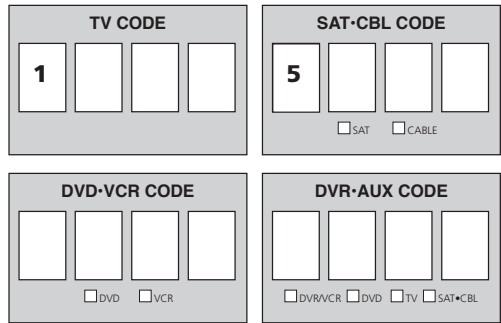

## Using the Remote to Control Your Components

Because this remote controls more than one component, you must first "tell" the remote which component you wish to operate. That means, if you wish to operate your TV, you must first press the TV key to put the remote in the TV Mode.

The remote stays in the chosen component mode (such as TV Mode) until you change it. If your remote is in TV Mode, you must change the mode in order to operate your DVD, VCR, DVR, auxiliary component, satellite receiver, or cable box. For example, if you are in DVD Mode, and you wish to turn off your TV, you must press the TV key first before pressing the POWER key.

## Accessing Component Menus and Guides

Today's advanced components use on-screen menus and guides to help you navigate through all their features and programming. While this remote may not access every menu or guide system of every component model, it does offer some menu and guide functionality.

To use a component's on-screen menu or guide system, you first have to put the remote in Menu or Guide Mode.

1. Make sure your components are turned on and your TV is set to a component input (Use the INPUT key to toggle through inputs when in TV Mode.)
2. Press the component key whose menu you want to access.
3. To access menus, press the MENU key. To access guides, press the GUIDE key. The LED blinks, indicating you are in Menu or Guide Mode.
4. Use the VOL+/- and CH+/- keys to navigate through the on-screen menu system or guide. To select the highlighted item, press the OK key.

**TIP:** If the remote doesn't respond, check to see that the LED is still blinking. The

LED times out after 20 seconds. If this happens, just press the MENU key again, and then retry your selection.

## Exiting a Menu Mode

The remote automatically times out of Menu Mode after 20 seconds of inactivity (no keys being pressed). At that time, the remote clears the displayed menu from the TV.

If you want to exit the Menu Mode yourself, press the corresponding component key on the remote (TV, SAT•CBL, DVD•VCR, DVR•AUX). The LED turns off.

# Troubleshooting

## **Problem: The remote does not operate your component.**

- You must put the remote in the correct mode by pressing the corresponding component key (TV, SAT•CBL, DVD•VCR, DVR•AUX) so the remote knows which component you want to operate.
- Remove any obstacles between the remote and the component. Make sure to aim the remote at the IR sensor on the component.
- Make sure the batteries are fresh and are properly installed. (See Battery Installation on page 1.) Replace the batteries with two new AAA batteries, if necessary. Reprogramming may be required.
- Reset the remote. Remove the batteries, then press and hold the number 1 key on the remote for several seconds to reset the microprocessor inside the remote. Release the number 1 key, reinstall the batteries, and press the POWER key. If the LED lights up, reprogram the remote and try again. If the LED doesn't light up, replace the batteries with new ones.

## **Problem: The remote can't be programmed to operate your component.**

- If you are testing the remote after you have entered the code, you may be too far away from the component or at a wrong angle. This remote uses IR (infrared) technology to communicate with components. The remote sends the code, and the component's IR sensor reads the code. Therefore, there must be an unobstructed path between the remote and the IR sensor on the component. Move closer and make sure you point the remote at the component (DVD player or VCR when programming the DVD•VCR key; TV when programming the TV key; satellite or cable box when programming the SAT•CBL key, DVR or auxiliary component when programming the DVR•AUX key).
- If you've used the Direct Entry programming methods to enter the codes for your brand and the unit is still not functioning properly, try one of the Code Search methods. (See pages 3–5.)
- To control combo units, like TV/VCRs or TV/DVDs, you must program the individual corresponding component keys to control each part of the combo unit. Once programmed successfully, the TV key controls the TV functions, and the DVD•VCR key controls the VCR or DVD functions. There is a specific section in the Code Lists for combo units. The codes in this section should be tried first using Direct Code Entry on the TV and DVD•VCR keys. If this is unsuccessful, follow the normal programming methods for both the TV and the DVD•VCR keys.
- Make sure the batteries are fresh and are properly installed.

## **Problem: The remote doesn't perform commands properly.**

- You must put the remote in the correct mode by pressing the corresponding component key (TV, SAT•CBL, DVD•VCR, DVR•AUX) so the remote knows which component you want to operate.
- Make sure component is "ready" (e.g., DVD player has disc loaded; VCR has tape loaded, etc.).
- You may have pressed an invalid key for the mode the remote is in.
- If you're trying to turn on an RCA, GE, or PROSCAN component, press the component key (TV, SAT•CBL, DVD•VCR, DVR•AUX) instead of the POWER key.
- If you're trying to enter a channel number directly, try pressing the ENTER key after entering the channel number as this is a requirement of certain models and brands.
- There is a possibility that a programmed code may only be able to control some of your component features (e.g., only turns a component on and off). To confirm that the component key is programmed with the correct code for maximum functionality, test the component. Attempt to control a variety of the component's functions with the remote. If some of the features of your components do not work, try programming the remote with a different code in the list using the Direct Code Entry Method, until you find the code that allows the remote to control the majority of your component's functions. Different codes can provide different levels of functionality.

## **Problem: The LED does not light when you press a key.**

- You may have pressed an invalid key for the mode the remote is in. You must put the remote in the correct mode by pressing the corresponding component key (TV, SAT•CBL, DVD•VCR, DVR•AUX) so the remote knows which component you want to operate.

- Make sure the batteries are fresh and are properly installed. (See Battery Installation on page 1.) Replace the batteries with two new AAA batteries, if necessary. Reprogramming may be required.

## **Problem: The VCR won't record.**

- Make sure the remote is in DVD•VCR Mode.
- Make sure the tape is properly loaded in the VCR.
- Make sure the tape is not write-protected. If the safety tab is removed the tape is write-protected, and you cannot record onto that tape.

## **Problem: The remote will not change channels on component.**

- You must put the remote in the correct mode by pressing the corresponding component key (TV, SAT•CBL, DVD•VCR, DVR•AUX) so the remote knows which component you want to operate.
- Press the ENTER key after you enter a channel number.
- Remove any obstacles between the remote and the component. Make sure to aim the remote at the IR sensor on the component.

## **Problem: The component's menu does not appear on the TV screen.**

- Make sure you have connected your component to your TV properly and selected the correct input. (See your components' Owner's Manuals for proper connection procedures.)
- You must put the remote in the correct mode by pressing the corresponding component key (TV, SAT•CBL, DVD•VCR, DVR•AUX) so the remote knows which component you want to operate.
- Menu access isn't supported for all brands. If that's the case, you'll need to use your original remote control to access menu functions for these components.

**For more information, please visit [www.rca.com](http://www.rca.com)**

## **Limited Lifetime Warranty**

Audiovox Electronics Corporation (the "Company") warrants to you the original retail purchaser of this product that should it, under normal use and conditions, be proven defective in material or workmanship during its lifetime while you own it, such defect(s) will be repaired or replaced (at the Company's option) without charge for parts and repair labor. To obtain repair or replacement within the terms of this Warranty, the product is to be delivered with proof of warranty coverage (e.g. dated bill of sale), specification of defect(s), transportation prepaid, to the Company at the address shown below.

This Warranty does not cover product purchased, serviced or used outside the United States or Canada. This Warranty is not transferable and does not extend to costs incurred for installation, removal or reinstallation of the product. This Warranty does not apply if in the Company's opinion, the product has been damaged through alteration, improper installation, mishandling, misuse, neglect, accident, or the simultaneous use of different battery types (e.g. alkaline, standard or rechargeable).

THE EXTENT OF THE COMPANY'S LIABILITY UNDER THIS WARRANTY IS LIMITED TO THE REPAIR OR REPLACEMENT PROVIDED ABOVE AND, IN NO EVENT, SHALL THE COMPANY'S LIABILITY EXCEED THE PURCHASE PRICE PAID BY PURCHASER FOR THE PRODUCT.

This Warranty is in lieu of all other express warranties or liabilities. ANY IMPLIED WARRANTIES, INCLUDING ANY IMPLIED WARRANTY OF MERCHANTABILITY OR FITNESS FOR A PARTICULAR PURPOSE SHALL BE LIMITED TO DURATION OF THIS WARRANTY. IN NO CASE SHALL THE COMPANY BE LIABLE FOR ANY CONSEQUENTIAL OR INCIDENTAL DAMAGES WHATSOEVER. No person or representative is authorized to assume for the Company any liability other than expressed herein in connection with the sale of this product.

Some states/provinces do not allow limitations on how long an implied warranty lasts or the exclusion or limitation of incidental or consequential damage so the above limitations or exclusions may not apply to you. This Warranty gives you specific legal rights and you may also have other rights, which vary from state/province to state/province.

U.S.A.: Audiovox Electronics Corporation, 150 Marcus Blvd., Hauppauge, New York 11788

CANADA: Audiovox Return Center, c/o Genco, 6685 Kennedy Road, Unit 3, Door 16, Mississauga, Ontario L5T 3A5

©2007 Audiovox Corporation  
Accessories Group  
111 Congressional Blvd., Suite 530  
Carmel, IN 46032

Trademark(s) © Registered  
RCR4273 US 03  
RCR4373 US 03

## Free Manuals Download Website

<http://myh66.com>

<http://usermanuals.us>

<http://www.somanuals.com>

<http://www.4manuals.cc>

<http://www.manual-lib.com>

<http://www.404manual.com>

<http://www.luxmanual.com>

<http://aubethermostatmanual.com>

Golf course search by state

<http://golfingnear.com>

Email search by domain

<http://emailbydomain.com>

Auto manuals search

<http://auto.somanuals.com>

TV manuals search

<http://tv.somanuals.com>