

RCA

Digital Media Recorder User's Guide

Changing Entertainment. Again.



GUIDE *plus+*
GAMESMAN

DRC7005N

Table of Contents

Chapter 1: Connections and Setup

Things to consider before you connect	2
Choose your connection	3
Connection: Digital Media Recorder + TV + VCR (optional)	4
Connection: Digital Media Recorder + TV + Cable Box	6
Connection: Digital Media Recorder + TV + Satellite Receiver	8
Connecting the Digital Media Recorder to an Audio Receiver	10
Connect the G-LINK cable	11
Install batteries in the remote control	12
Turn on the TV and the Digital Media Recorder	12
Complete On-Screen Setup	12
What to Expect	15
How to find your TV's Video Input Channel	16
Next Steps	16

Chapter 2: The Remote Control17

Explanation of buttons	18
Programming the remote to operate your TV	19
Programming the remote to operate other components	19
Code list for programming the remote control	20

Chapter 3: Using the Recorder's Features

Watching TV	24
Pausing Live TV	24
Recording	24
Stopping or pausing recording	24
Watching one channel while you record another channel	25
Recording from the GUIDE Plus+ on-screen programming guide	25
Setting up Timer Recordings to record programs automatically	25
Copying music and/or pictures	26
Playback	27
About the GUIDE Plus+ On-Screen Programming Guide	28
Listings	29
Sort	29
News	30
Messages	30
Promotions	30
Schedule	30
Setup	30

Chapter 4: Playing Discs31

Regional Coding	32
Using Different Menus	32
How to Load and Play Discs	32
Search Options	33
Playback Options	33
Using the On-Screen Info Display	34
Time Display	35
Selecting a Title	35
Selecting a Chapter	35
Selecting Subtitles	35
Repeat Feature	36
Changing the Audio Language	36
Changing the Camera Angle	37
Play Mode Feature (Audio CD only)	37
IntroScan (Audio CD only)	38
PlayBack Control (PBC), Video CD only	38
Playing mp3 Discs	39
Viewing JPEG files	40

Chapter 5: The Menu System41

Overview of the Menu System	42
Channels Menu	43
Disc Menu	43
Start	43
Screen Format	43
Playlist	43
Save	43
AutoPlay	43
DVD Menu	43
DVD Title	43
Video Menu	44
Music Menu	44
Pictures Menu	44
Recordings Menu	44
Timer	44
GUIDE Plus+	44
Recording Quality	44
Setup Menu	45
Parental Controls	45
Options	45
Digital Output	45
SRS/TruSurround	45
Black Level	45
Dimmer	45
Languages Menu	45
Display	45
Audio	45
Subtitles	45
Disc	45
Installation Menu	46
Interactive Setup	46
Channel Search	46
Manual Clock	46
Channel List	46
Guide Plus	46
How to use Parental Control Feature	47
Lock and Unlock	47
Password	47
Rating Limits	48
Unrated Titles	48

Chapter 6: Additional Information49

Troubleshooting	50
Handling Cautions	53
Back of the Digital Media Recorder (explanation of jacks)	54
Front of the Digital Media Recorder (explanation of buttons and controls) ..	55
Explanation of Input Jacks, Output Jacks and Cables	56
Limited Warranty	57
Accessories	59
Copying content stored on the Digital Media Recorder to a VCR	60

Chapter 1: Connections and Setup

Things to consider before you connect

Protect components from overheating

- Don't block ventilation holes on any of the components. Arrange the components so that air can circulate freely.
- Don't stack components.
- When you place components in a stand, make sure you allow adequate ventilation.
- If you connect an audio receiver or amplifier, place it on the top shelf.

CAUTION: You must turn off the Digital Media Recorder before you move it. Moving the unit while it is powered on could damage the hard disk drive.

Position cables properly to avoid audio interference

- Insert each cable firmly into the designated jack.
- If you place components above the TV, route all cables down the side of the back of the TV instead of straight down the middle of the back of the TV.
- If your antenna uses 300-ohm twin lead cables, do not coil the cables. Also, keep the twin lead cables away from audio/video cables.

Connection Pictures

Audio/video cables are usually bundled together. For better visibility, the connection pictures in this book show each cable separately (audio left, audio right, and video).
Graphics contained within this publication are for representation only.



Some discs may not be compatible due to laser pickup and disc design.

Types of discs your DVD player can play

- DVD discs – contain picture and sound (DVD-R, DVD+RW are compatible with this player) .
- CDs (CD-R, CD-RW) – Audio CDs contain musical or sound content only. mp3 discs are CDs that contain mp3 files. This product also plays CDs that contain JPEG files and Multisession CDs.
- Video CD (VCD) and Super Video CD (S-VCD) discs – Like DVD video discs, VCDs contain picture and sound content. The difference is the amount of information that can be stored on the disc. VCDs typically have lower picture and sound quality than DVD discs. Super Video CDs (S-VCDs) can be used to record up to 70 minutes of digital sound and video, with MPEG-2 standard video and MPEG-1 standard audio. S-VCD disc compatibility is dependent on which MPEG coding software, disc design software, disc writer software are used, and the discs themselves.

Unpack the Box

Your Digital Media Recorder came with the following items:

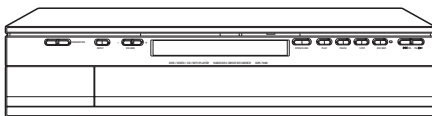

Digital Media Recorder

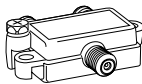

2 Way Splitter (part number VH47)

You must connect the 2 Way Splitter in order to watch one program while you record another one to the Digital Media Recorder's hard disk drive.

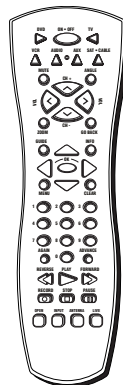

Remote control and batteries (part number 257873)



Power cord (part number 218104)



G-LINK cable (part number 246990)

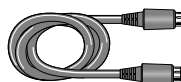

S-Video cable (part number 257982)

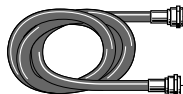

RF Coaxial cable (part number 221396)

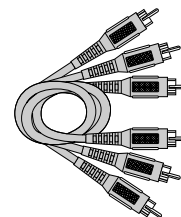

1 set of audio video cables (part number 233086)

Choose Your Connection

There are several ways to connect your Digital Media Recorder. Please use the following chart to determine which connection is best for you. Turn to the appropriate page for specific instructions.

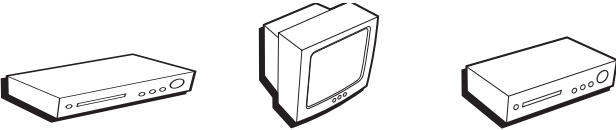
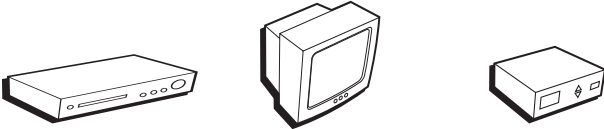
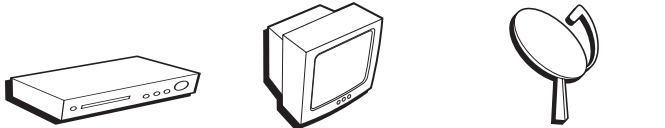
Components	Cables Needed	Connection Title	Go to...
 <p>Digital Media Recorder TV VCR (optional)</p>	<ul style="list-style-type: none"> • Coaxial • Audio/video • S-Video (optional) 	<p>TV + VCR</p>	<p>4</p>
 <p>Digital Media Recorder TV Cable Box</p>	<ul style="list-style-type: none"> • Coaxial • Audio/video • S-Video (optional) 	<p>TV + VCR + cable box</p>	<p>6</p>
 <p>Digital Media Recorder TV Satellite Receiver</p>	<ul style="list-style-type: none"> • Coaxial • Audio/video • S-Video (optional) 	<p>TV + satellite receiver</p>	<p>8</p>

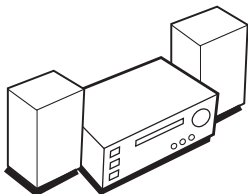

Connecting an optional audio receiver: After you connect the Digital Media Recorder to your TV (choose an option above), go to page 10 for general information.

Chapter 1: Connections and Setup

Details about the different kinds of cables used to connect your Digital Media Recorder are on page 56.

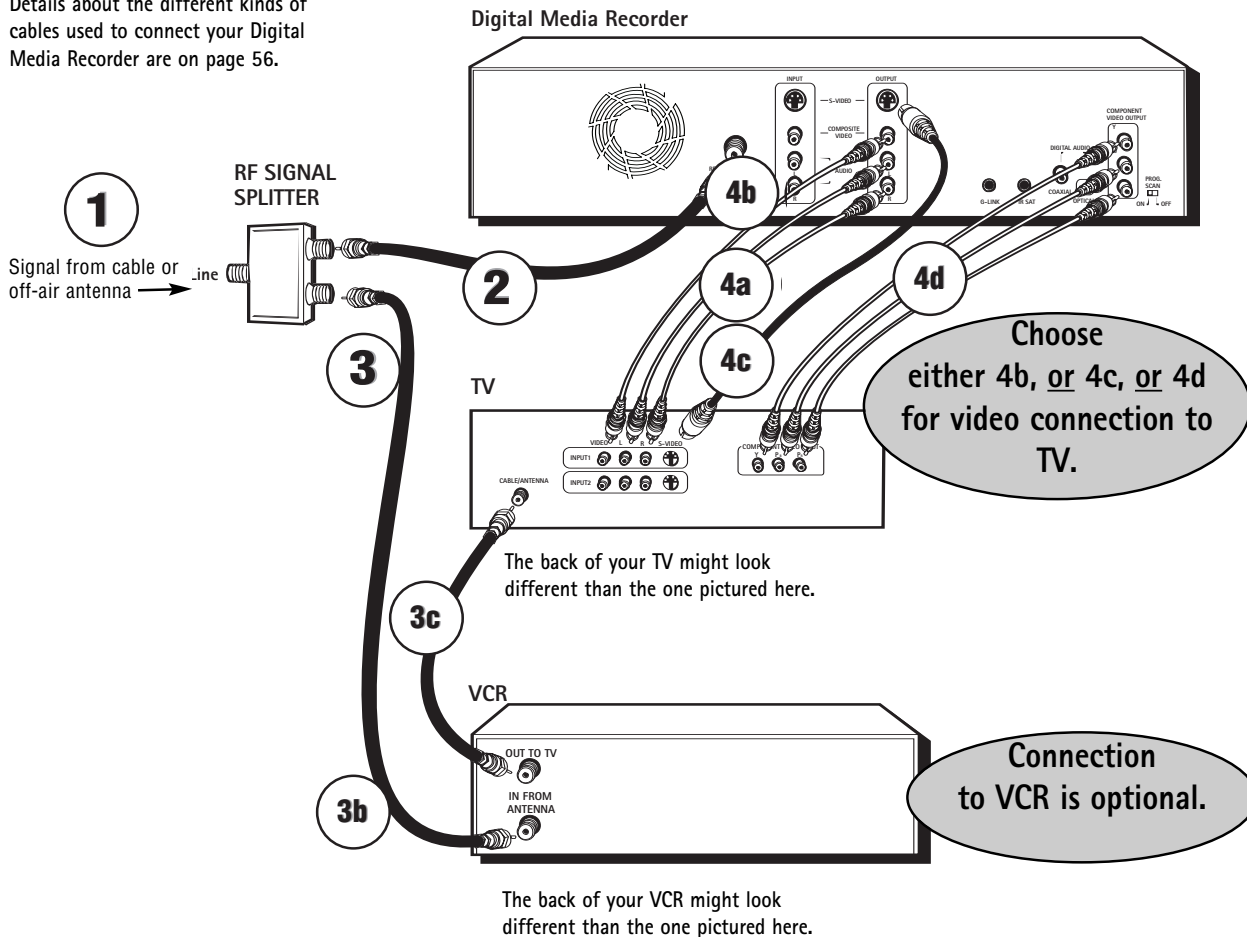

If you connect your components as described, you must access different Video Input Channels on your TV to see programming— whether the programming is a regular TV show, a program you saved to the Digital Media Recorder's hard disk drive, or a disc you're playing in the Digital Media Recorder. If you don't know how to access Video Input Channels on your TV, go to page 16 for help. A general explanation, based on the connection shown above, follows:

-
- | | |
|--|--|
| To watch one program while you record another: | <p>Tune the TV to its Input 1 channel or Vid 1 channel</p> <p>Tune the Digital Media Recorder to the channel you want to record, and press RECORD.</p> <p>Use the buttons on the TV (or the TV's remote control*) to tune to the channel you want to watch – you won't be able to pause live TV because you aren't watching TV through the Digital Media Recorder.</p> |
| <hr/> | |
| To play a disc or a show you've recorded to the Digital Media Recorder's hard disk drive: | <p>Tune the TV its Input 1 channel or Vid 1 channel.</p> |
| <hr/> | |
| To play a videotape: | <p>Tune the TV to the VCR input channel (usually channel 3 or 4).</p> |
-

If you need help finding your TV's various Video Input Channels, go to page 16.

* The remote control packed with your Digital Media Recorder is capable of being programmed to operate many brands and models of TVs and VCRs. For instructions, go to page 19.

Connection: Digital Media Recorder + TV + VCR (optional)

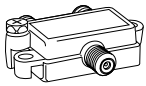

2 Way Splitter
(provided)

1. Connect the signal (cable or antenna)

Note: Depending upon how you currently have your TV and/or a VCR connected, you'll have to disconnect the cable from your TV's Antenna Input jack (sometimes labelled CABLE/ANTENNA) or from your VCR's IN FROM ANTENNA before you connect it as explained below.

Cable service: If you have cable service via a cable that comes out of the wall, connect the end of that cable that to the 2 Way Splitter (provided) – connect the cable to the end of the 2 Way Splitter that only has one connector. If you have a cable box, go to page 6.

Off-air antenna: If you use an off-air antenna to get TV programming, connect the antenna's RF coaxial cable to the end of the 2 Way Splitter that only has one connector.

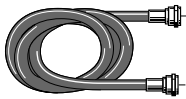

RF Coaxial cable

2. Use the RF Coaxial cable that was packed with your Digital Media Recorder, and connect one end to the 2 Way Splitter – connect the cable to the end that has two connectors (it doesn't matter which of the two connectors you use). Connect the other end to the RF ANTENNA/CABLE INPUT jack on the back of the Digital Media Recorder.

3. Connect another RF Coaxial cable to the other connector that's available on the 2 Way Splitter. If you want to keep a VCR connected to the TV, go to 3b.

3a. If you aren't connecting a VCR to the TV, (not shown) connect the other end of this RF Coaxial cable to your TV's Antenna Input jack (sometimes labeled CABLE/ANTENNA or ANTENNA IN).

3b. If you want to keep a VCR connected to the TV, connect the other end of this RF Coaxial cable to your VCR's Antenna Input jack (sometimes labeled IN FROM ANTENNA).

3c. Connect one end of another RF Coaxial cable to your VCR's Antenna Output jack (sometimes labeled OUT TO TV), and connect the other end to the TV's Antenna Input jack (sometimes labeled CABLE/ANTENNA).

For more information about the other Input jacks on the back of the Digital Media Recorder, go to page 54.

Connect the Digital Media Recorder to the TV

4. You need to connect cables to the Digital Media Recorder's OUTPUT jacks to the TV's INPUT jacks in order to see the content from the Digital Media Recorder (whether it's a TV program, something you recorded to the hard disk drive, or a disc you're playing).

- 4a. Connect the audio cables.

A set of audio/video cables was packed with your Digital Media Recorder. Connect the audio cables to the OUTPUT AUDIO L (left – white) and R (right – red) jacks on the back of your Digital Media Recorder, and to the corresponding Audio Input jacks on your TV (sometimes labeled AUDIO IN L and R).

- 4b. Connect the video cable. The cables you use for the video determine the quality of the picture you'll see on your TV when you're playing DVDs. For more information about cables and signal quality, go to page 56.

Good: Connect the video cable (yellow) to the OUTPUT COMPOSITE VIDEO jack on the back of your Digital Media Recorder, and to the Video Input jack on your TV (sometimes labeled VIDEO IN).

OR

- 4c. **Better:** If your TV has an S-VIDEO jack, connect one end of the S-Video cable (provided) to the S-VIDEO jack on the back of the TV and the other end to the OUTPUT S-VIDEO jack on the back of the Digital Media Recorder.

OR

- 4d. **Best:** If your TV has Component Input Jacks (Y, Pb, Pr), you can achieve even greater picture quality by connecting the Digital Media Recorder to the TV using these jacks (COMPONENT VIDEO OUTPUT, Y, Pb, Pr on the Digital Media Recorder). Go to page 56 for more information.

Note: If your TV is capable of progressive scan, connect the Digital Media Recorder to the TV using the COMPONENT VIDEO OUTPUT jacks (see 4d above), and slide the PROG SCAN switch to the ON position to see DVD titles (movies) in progressive scan format. If you need more explanation, go to page 55.

5. Attach the AC power cord to the unit.
6. Insert the other end of the AC power cord into an AC outlet (or power strip).

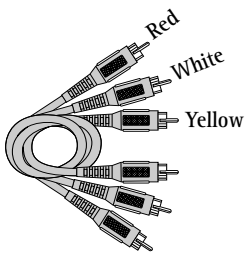

Audio video cables are usually color-coded red, white, and yellow.

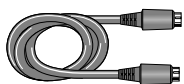

S-Video cable

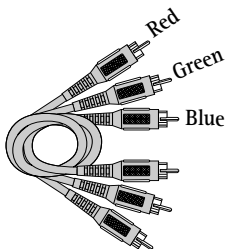

Component video cables are sometimes color-coded red, green, and blue. You can also use three standard video cables (usually color-coded yellow).

Go to page 12

Chapter 1: Connections and Setup

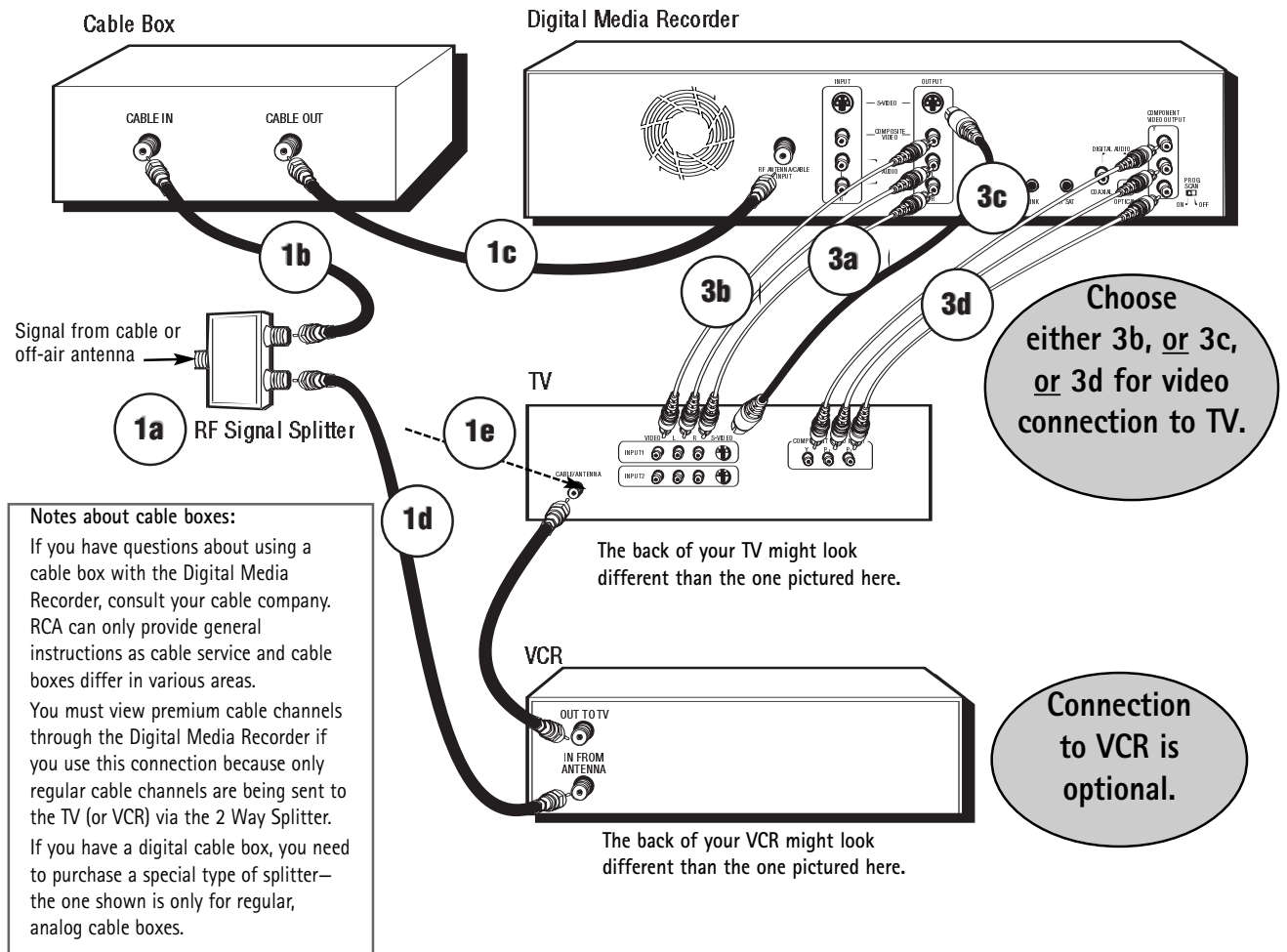

If you connect your components as described, you must access different Video Input Channels on your TV to see programming— whether the programming is a regular TV show, a program you saved to the Digital Media Recorder's hard disk drive, a videotape you're playing in the VCR, or a disc you're playing in the Digital Media Recorder. If you don't know how to access Video Input Channels on your TV, go to page 16 for help. A general explanation, based on the connection shown above, follows:

To watch one program while you record another:

- Tune the TV to its Input 1 channel or Vid 1 channel
- Tune the Digital Media Recorder to the cable box channel (usually channel 2, 3, or 4).
- Tune the cable box to the channel you want to record.
- Press the RECORD button on the Digital Media Recorder.
- Use the buttons on the TV (or the TV's remote control*) to tune to the channel you want to watch – you won't be able to pause live TV because you aren't watching TV through the Digital Media Recorder.

To play a disc or a show you've recorded to the Digital Media Recorder:

- Tune the TV its Input 1 channel or Vid 1 channel.

To play a videotape:

- Tune the TV to the VCR input channel (usually channel 3 or 4).

If you need help finding your TV's various Video Input Channels, go to page 16.

* The remote control packed with your Digital Media Recorder is capable of being programmed to operate many brands and models of TVs and VCRs. For instructions, go to page 19.

Connection: Digital Media Recorder + TV + Cable Box

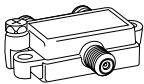

2 Way Splitter
(provided)

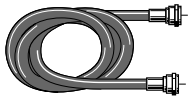

RF Coaxial cable

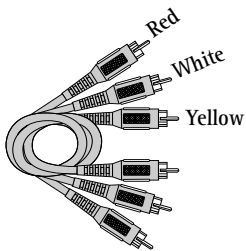

Audio video cables are usually color-coded red, white, and yellow.

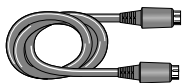

S-Video cable

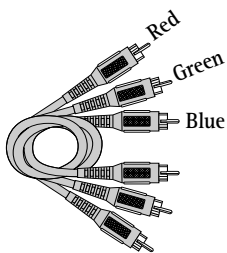

Component video cables are sometimes color-coded red, green, and blue. You can also use three standard video cables (usually color-coded yellow).

1. Connect the 2 Way Splitter (provided) to split the cable signal

Note: Before you connect the Digital Media Recorder, you'll need to disconnect some of the cables first in order to re-connect them.

1a. Disconnect the RF Coaxial cable that originates from the cable signal coming into your house, and goes to the cable box. Connect this RF Coaxial cable to the 2 Way Splitter that was packed with your Digital Media Recorder – connect the cable to the end of the 2 Way Splitter that has only one connector.

1b. Use the RF Coaxial cable that was packed with your Digital Media Recorder, and connect one end to the 2 Way Splitter – connect the cable to the end that has two connectors (it doesn't matter which of the two connectors you use). Connect the other end of this cable to the Cable Signal Input jack on the cable box.

1c. Connect another RF Coaxial cable to the cable box's TV Output Jack (sometimes labeled OUT TO TV); and connect the other end to the RF ANTENNA/CABLE INPUT jack on the back of the Digital Media Recorder.

1d. Connect another RF Coaxial cable to the other connector that's available on the 2 Way Splitter. Connect the other end of that cable to your VCR's Antenna Input jack (sometimes labeled CABLE/ANTENNA IN). **If you're NOT connecting a VCR, go to 1e.**

1e. Connect another RF Coaxial cable to the other connector that's available on the 2 Way Splitter. Connect the other end of that cable to your TV's Antenna Input jack (sometimes labeled CABLE/ANTENNA).

For more information about the other Input jacks on the back of the Digital Media Recorder, go to page 54.

2. Connect the VCR to the TV (optional)

If you connected a VCR (step 1d above), connect one end of an RF Coaxial cable to the VCR's Output jack (sometimes labeled OUT TO TV) and the other end to the TV's Input jack (sometimes labeled CABLE/ANTENNA). If you didn't connect a VCR, skip this step and proceed to step 3.

3. Connect the Digital Media Recorder to the TV

You need to connect cables to the Digital Media Recorder's OUTPUT jacks to the TV's INPUT jacks in order to see the content from the Digital Media Recorder (whether it's a TV program, something you recorded to the hard disk drive, or a disc you're playing).

3a. Connect the audio cables.

A set of audio/video cables was packed with your Digital Media Recorder. Connect the audio cables to the OUTPUT AUDIO L (left – white) and R (right – red) jacks on the back of your Digital Media Recorder, and to the corresponding Audio Input jacks on your TV (sometimes labeled AUDIO IN L and R).

3b. Connect the video cable. The cables you use for the video determine the quality of the picture you'll see on your TV when you're playing DVDs. For more information about cables and signal quality, go to page 56.

Good: Connect the video cable (yellow) to the OUTPUT COMPOSITE VIDEO jack on the back of your Digital Media Recorder, and to the Video Input jack on your TV (sometimes labeled VIDEO IN)

OR

3c. **Better:** If your TV has an S-VIDEO jack, connect one end of the S-Video cable (provided) to the S-VIDEO jack on the back of the TV and the other end to the OUTPUT S-VIDEO jack on the back of the Digital Media Recorder.

OR

3d. **Best:** If your TV has Component Input Jacks (Y, Pb, Pr), you can achieve even greater picture quality by connecting the Digital Media Recorder to the TV using these jacks (COMPONENT VIDEO OUTPUT, Y, Pb, Pr on the Digital Media Recorder). For more explanation, go to page 56.

Note: If your TV is capable of progressive scan, connect the Digital Media Recorder to the TV using the COMPONENT VIDEO OUTPUT jacks (see 3d above), and slide the PROG SCAN switch to the ON position to see DVD titles (movies) in progressive scan format. If you need more explanation, go to page 55.

4. Attach the AC power cord to the unit.

5. Insert the the other end of the AC power cord into an AC outlet (or power strip).

Go to page 11

Notes: This connection enables you to watch one channel while you record another channel to the Digital Media Recorder's hard disk drive by splitting the cable signal. If your cable box is necessary for premium channels, you won't be able to access them when watching TV directly (i.e., without going through the Digital Media Recorder by tuning the TV to its Video Input Channel).

Chapter 1: Connections and Setup

Details about the different kinds of cables used to connect your Digital Media Recorder are on page 56.

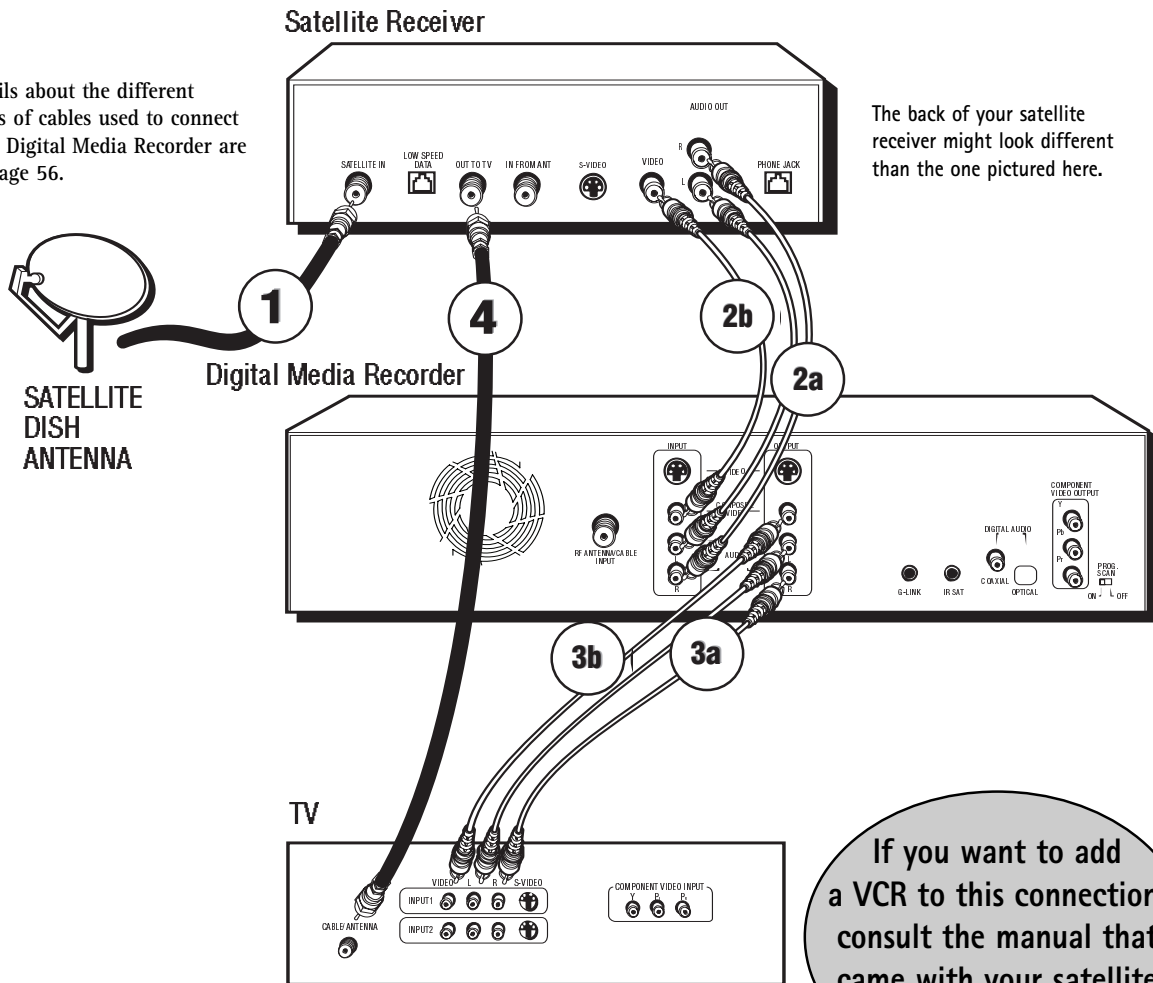

The back of your satellite receiver might look different than the one pictured here.

If you want to add a VCR to this connection, consult the manual that came with your satellite receiver.

The back of your TV might look different than the one pictured here.

-
- To watch TV (satellite programming)**
 - Tune the TV to its Input 1 channel or Vid 1 channel
 - Tune the Digital Media Recorder to the INPUT 1 channel (press INPUT on the remote).
 - Tune the satellite receiver to the channel you want to watch.

 - To watch TV (satellite programming) with the Digital Media Recorder turned off.**
 - Note: You won't be able to pause programming or record to the Digital Media Recorder.
 - Tune the TV its CABLE/ANTENNA INPUT channel (usually channel 2, 3, or 4).
 - Tune the satellite receiver to the channel you want to watch.

- To play a disc or a show you've recorded to the Digital Media Recorder:**
 - Tune the TV to Input 1 channel or Vid 1 channel.

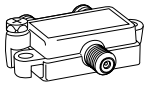

2 Way Splitter
(provided)

Connection: Digital Media Recorder + TV + Satellite Receiver

The following instructions enable you to record the programs from your satellite receiver to the Digital Media Recorder's hard disk drive. Keep in mind that the author of these instructions doesn't know exactly what jacks are on the back of your satellite receiver or your TV. Therefore, the steps provided are general guidelines. If you have cable TV service AND satellite TV, you can connect the cable signal to the Digital Media Recorder's RF ANTENNA/CABLE INPUT jack.

1. Leave the cable in place that comes from the satellite dish and goes to the satellite receiver.
2. **Connect the satellite receiver to the Digital Media Recorder**
 - 2a. Connect audio cables (red and white) to the satellite receiver's output jacks [sometimes labeled Audio Left (white) and Audio Right (red)]. Connect the other ends of these cables to the corresponding INPUT AUDIO L and AUDIO R jacks on the back of the Digital Media Recorder.
 - 2b. Connect the video cable (yellow) to the Video Output jack on the satellite receiver (sometimes labelled VIDEO) to the INPUT COMPOSITE VIDEO jack on the back of the Digital Media Recorder.

Note: If your satellite receiver doesn't have a Video Output jack, connect an RF coaxial cable to the satellite receiver's OUT TO TV jack, and to the Digital Media Recorder's RF ANTENNA/CABLE INPUT jack.

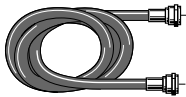

RF Coaxial cable

3. **Connect the Digital Media Recorder to the TV**

You need to connect cables to the Digital Media Recorder's OUTPUT jacks to the TV's INPUT jacks in order to see the content from the Digital Media Recorder (whether it's a TV program, something you recorded to the hard disk drive, or a disc you're playing).

- 3a. Connect the audio cables.

A set of audio/video cables was packed with your Digital Media Recorder. Connect the audio cables to the OUTPUT AUDIO L (left - white) and R (right - red) jacks on the back of your Digital Media Recorder, and to the corresponding Audio Input jacks on your TV (sometimes labeled AUDIO IN L and R).

- 3b. Connect the video cable. The cables you use for the video determine the quality of the picture you'll see on your TV when you're playing DVDs. For more information about cables and signal quality, go to page 56.

Good: Connect the video cable (yellow) to the OUTPUT COMPOSITE VIDEO jack on the back of your Digital Media Recorder, and to the Video Input jack on your TV (sometimes labeled VIDEO IN)

OR

- 3c. **Better (Not shown):** If your TV has an S-VIDEO jack, connect one end of the S-Video cable (provided) to the S-VIDEO jack on the back of the TV and the other end to the OUTPUT S-VIDEO jack on the back of the Digital Media Recorder.

OR

- 3d. **Best (Not shown):** If your TV has Component Input Jacks (Y, Pb, Pr), you can achieve even greater picture quality by connecting the Digital Media Recorder to the TV using these jacks (COMPONENT VIDEO OUTPUT, Y, Pb, Pr on the DVD Recorder). For more information about cables and signal quality, go to page 56.

Note: If your TV is capable of progressive scan, connect the Digital Media Recorder to the TV using the COMPONENT VIDEO OUTPUT jacks (see 3d above), and slide the PROG SCAN switch to the ON position to see DVD titles (movies) in progressive scan format. If you need more explanation, go to page 55.

4. **Connect the satellite receiver to the TV**

Connect an RF coaxial cable to the OUT TO TV jack on the satellite receiver, and to the Cable/Antenna input jack on the TV (sometimes labelled CABLE/ANTENNA)

5. Attach the AC power cord to the unit.
6. Insert the the other end AC power cord into an AC outlet (or power strip).

7. **Connecting a VCR (not shown)**

If you want to connect a VCR to the satellite receiver and the TV, connect the RF Coaxial cable in step 4 to the VCR's Cable/Antenna Input jack. Connect another RF Coaxial cable to the VCR's OUT TO TV jack, and to the TV's CABLE/ANTENNA INPUT jack. For more information, consult the manuals that came with these products.

Go to page 11

Notes:

The GUIDE Plus+ System won't work if you use this connection because it doesn't interpret information from satellite programming. It only downloads cable TV listings and/or off-air broadcast listings.

You can't use the 2 Way Splitter that came with the Digital Media Recorder to split the satellite signal because it won't read digital signals properly. Therefore, you can't record one program and watch a different program at the same time.

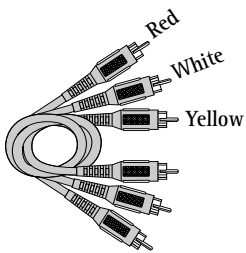

Audio video cables are usually color-coded red, white, and yellow.

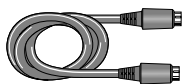

S-Video cable

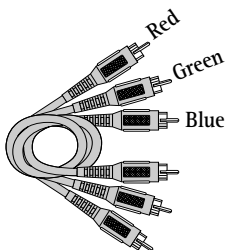

Component video cables are sometimes color-coded red, green, and blue. You can also use three standard video cables (usually color-coded yellow).

Chapter 1: Connections and Setup

Consult the manual that came with your receiver to connect it properly.

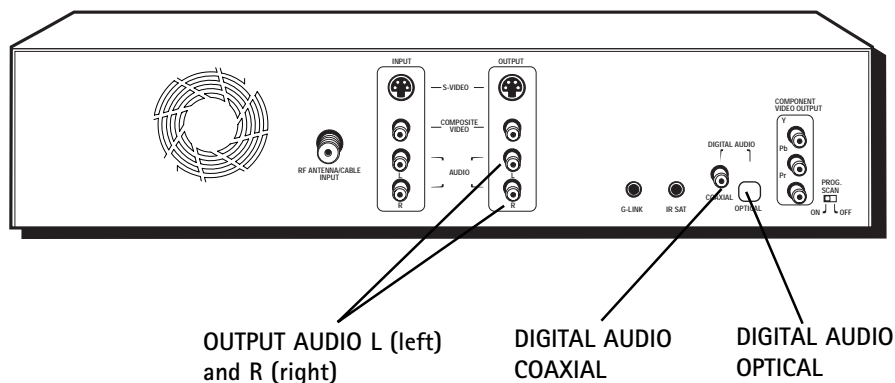

Advanced Audio Connection Information

Both Dolby Digital® and DTS® are audio formats used to record 5.1-channel audio signals onto the digital track of film (while the film is being made). Both of these formats provide up to six separate channels: left, right, center, left rear, right rear, and common subwoofer. The disc will play 5.1-channel sound only if you've connected a DTS or Dolby Digital receiver or decoder and if the disc is encoded in the Dolby Digital or DTS format.

Please Read This Before Using the DIGITAL AUDIO Jacks!

This unit's digital output jacks are designed for a connection to a Dolby Digital or DTS receiver or decoder. Older digital equipment may not be compatible with the Dolby Digital bitstream. Such a connection can create a high level of noise that may be harmful to your ears, and could damage headphones or speakers. It is important to choose the correct Digital Output setting in the Options menu, especially when you use either of the DIGITAL AUDIO jacks. For more information, go to page 45.

Connecting your Digital Media Recorder to an audio/video receiver

You'll need to consult instructions that came with your audio video receiver in order to connect it properly. The information below provides general guidelines for the Digital Media Recorder's Audio Output Jacks.

For a basic audio connection, connect the left and right audio cables to your audio/video receiver and to the OUTPUT AUDIO L (left – white) and R (right – red) jacks on the back of your Digital Media Recorder.

If you have a Dolby Digital or DTS receiver, use one of the DIGITAL AUDIO jacks to connect the receiver to the Digital Media Recorder. You must also adjust the *Digital Output* setting (go to page 45 for information).

Notes:
The DIGITAL AUDIO OUTPUT jack has two options: OPTICAL and COAXIAL. Some Dolby Digital receivers have one type of Digital Audio Input jack, and some have both. Under most conditions, optical and coaxial connections work equally well – the only difference is the type of cable you connect to the jack.

If you want to use a less expensive cable, connect a coaxial cable to the COAXIAL jack. Rarely, but sometimes, coaxial cables – especially long ones, pick up radio frequency (RF) interference from household appliances, nearby power lines, and/or broadcast towers.

If you would rather use the OPTICAL jack, connect an optical digital cable to the Digital Media Recorder and to the corresponding digital optical input jack on the receiver.

Remove the protective cover that's in the DIGITAL AUDIO OPTICAL jack before connecting cables.

Manufactured under license from Dolby Laboratories. "Dolby" and the double-D symbol are trademarks of Dolby Laboratories. Confidential unpublished works. © 1992-1997 Dolby Laboratories, Inc. All rights reserved.

DTS is a registered trademark of Digital Home Theater Systems, Inc.

Connect the cables to the G-LINK and/or IR SAT jacks on the back of the Recorder

If you connected a cable box or satellite receiver to the recorder, you must connect the G-LINK cable (provided) in order for all of the Digital Media Recorder's features to work correctly.

The G-LINK cable (provided) enables the Digital Media Recorder to control the cable box or satellite receiver so you can set up timer recordings. Connecting the G-LINK cable also enables the GUIDE Plus+ system (the on-screen programming guide) to list the correct programs.

Note: The GUIDE Plus+ System doesn't interpret information from satellite programming. It only downloads cable TV listings and/or off-air broadcast listings. Therefore, there won't be any program listings in the Digital Media Recorder's GUIDE Plus+ programming guide if you have satellite service.

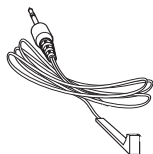

G-LINK cable

- 1a. If you connected a cable box, insert the G-LINK cable into the G-LINK jack on the back of the Digital Media Recorder.
- 1b. If you connected a satellite receiver, insert the G-LINK cable into the IR SAT jack on the back of the Digital Media Recorder.
2. Connect the other end of the cable (called a wand) in front of the remote sensor that's on front of the cable box or satellite receiver (see picture at the bottom of this page). Some cable boxes and satellite receivers have the remote sensor labelled, but some don't. If you see the remote sensor label on your cable box or satellite receiver, go to step 7 (sometimes it's labeled IR or remote or sensor). If you don't see a remote sensor label on your cable box or satellite receiver, go to step 3.
3. Turn off the cable box or satellite receiver.

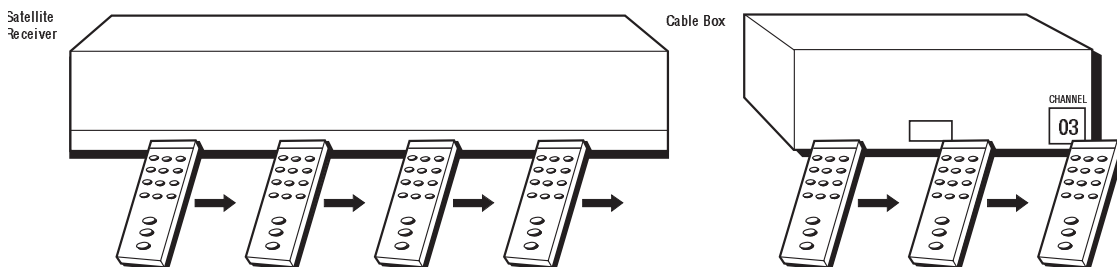

4. Hold the satellite receiver remote control or cable box remote control so that it is touching the front of the satellite receiver or cable box.
5. Slowly move the remote control in front of the satellite receiver or cable box while you press the power button on and off. You must press and release the power button each time you move the remote (holding down the button won't work).
6. When the satellite receiver (or cable box) turns on, you've located the sensor.

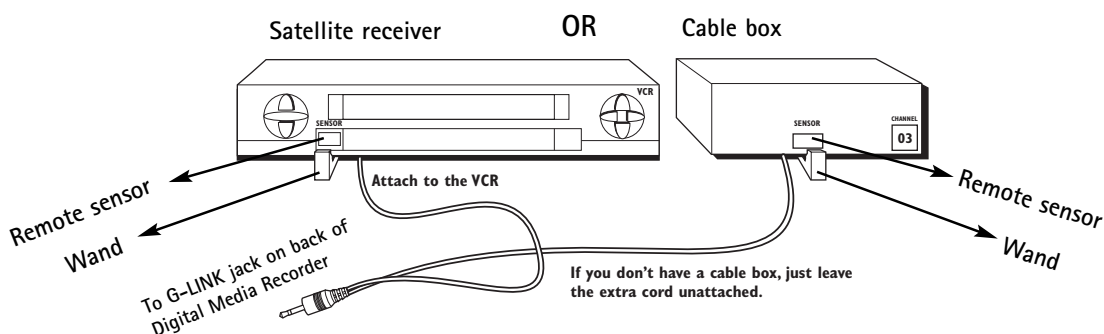

7. Place the wand in front of the remote sensor, approximately one inch away from the remote sensor.

Go to page 12

Chapter 1: Setup and Connections

Install Batteries in the Remote

1. Remove the battery compartment cover on the back of the remote.
2. Insert new batteries. Match the polarities (+ and -) on the batteries with the diagram on the remote.
3. Put the battery compartment cover back on the remote.

Important Battery Information

- If you're not going to use the remote for a month or more, be sure to remove the batteries because they can leak and cause damage.
- Dispose of batteries in the proper manner, according to federal, state, and local regulations.
- Any battery may leak electrolyte if mixed with a different battery type, if inserted incorrectly, if all batteries are not replaced at the same time, if disposed of in fire, or if an attempt is made to charge a battery not intended to be recharged.
- Discard leaky batteries immediately. Leaking batteries can cause skin burns or other personal injury.

Point the Remote in the Right Direction and Put it in DVD Mode

When you want the remote to operate the Digital Media Recorder, point the remote at the Digital Media Recorder, not the TV. The remote has to be pointed in the correct direction and toward the correct component in order for the remote control's signal to communicate with the sensor on the component. Make sure there is a clear path between the remote control and the component you want to operate, so the signal isn't blocked.

Make sure the remote is in DVD mode – press the DVD button.

Turn on the TV and Digital Media Recorder

1. If you have an RCA, GE, or Proscan TV, press the TV button on the remote and then press the INPUT button on the remote (the TV turns on and tunes to the correct Video Input Channel).

If you have another brand of TV, turn on the TV and tune the TV to the correct Video Input Channel (if you don't know how to access the Video Input channel on your TV, go to page 16 for help).

Note: You can program your remote to operate most brands of remote controllable TVs. Instructions are on page 19.

2. Press the DVD button on the remote control to put it in the correct mode, and turn on the Digital Media Recorder.

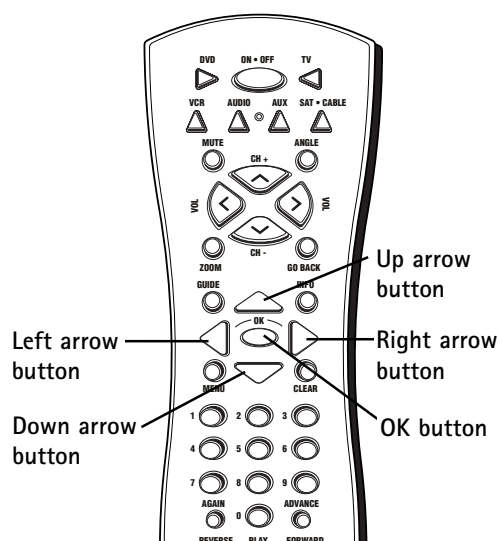

Use the arrow buttons on the remote to move through on-screen menus and highlight different options. Press the OK button to select a menu item that is highlighted.

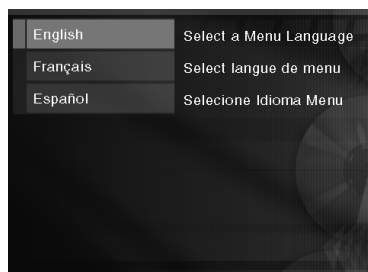

Complete the Interactive Setup

The next few pages step you through the series of screens that will appear the first time you turn on your Digital Media Recorder.

Use the remote control to follow the on-screen instructions. The arrow buttons move the on-screen highlight in the corresponding directions on the screen (up, down, left, right).

Press the OK button to select a highlighted item.

Notes:

You can access the setup screens from the main menu. If you move, get a different program provider for TV shows, or change your connections, you'll need to complete the Interactive Setup again.

If you don't see the Language selection screen (below) the first time you turn on the Digital Media Recorder, make sure you've tuned your TV to the Video Input Channel that corresponds to the way you've connected the TV to the Digital Media Recorder. If you need help, go to page 16.

1) Select on-screen menu language

Make sure the remote is in DVD mode (press the DVD button). If you want the on-screen menus to appear in *English*, press the OK button on the remote control. If you prefer another language, press the arrow down button until that language is highlighted. Press OK to select the language.

Note: If you don't see the Language selection screen the first time you turn on the Digital Media Recorder, make sure you've tuned your TV to the Video Input Channel that corresponds to the way you've connected the TV to the Digital Media Recorder. If you need help, go to page 16.

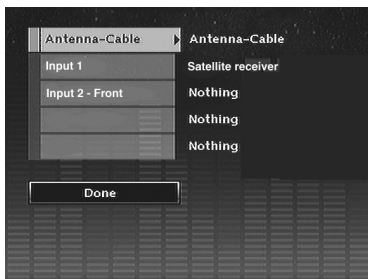

2) Connection List

Completing this information lets the Digital Media Recorder know what program signals are being sent to it. Choose the component that is connected to each of the jacks on the Recorder.

a. **Cable-Antenna** (RF ANTENNA/CABLE INPUT jack connection): Press the right arrow button to choose what you connected to the RF ANTENNA IN jack on the back of your Digital Media Recorder. The choices follow:

Antenna-Cable (cable without a cable box)

Antenna Only (no cable service, just off-air antenna)

Cable Receiver (cable service with a cable box)

Satellite Receiver (satellite programming)

Nothing (select this setting if you didn't connect anything to the RF ANTENNA/CABLE INPUT jack on the back of the Digital Media Recorder).

Follow this procedure for all of the other INPUT jacks on the Digital Media Recorder.

- b. **INPUT 1** (the INPUT jack, S-VIDEO or COMPOSITE VIDEO, on the back of the Digital Media Recorder)
- c. **INPUT 2-Front** (the jacks on the front of the Digital Media Recorder – you have to open the door on left side of the unit to see them).
- d. When you're finished, press the down arrow button on the remote to highlight Done and press the OK button.

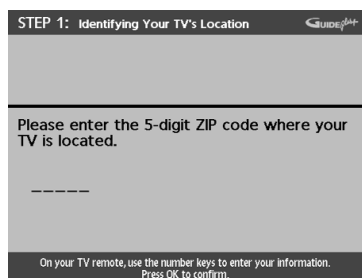

3) GUIDE Plus+ setup

Your Digital Media Recorder is equipped with the GUIDE Plus+ system, a no-fee, interactive, on-screen program guide that lists what shows are on TV in your area. In order to see program listings, you need to complete the following steps.

Note: The setup screens may tell you to locate a Quick Setup guide. Please disregard, as the instructions are contained in this User's Guide.

a. First, identify your TV's location. Use the arrow buttons to select your country and press OK. Use the number buttons on the remote to enter your zip code or postal code, and press OK.

b. The next series of screens asks you about your cable setup. Follow the on-screen instructions.

If you don't have a cable box connected to your TV or Digital Media Recorder, skip to step 3d.

c. If you connected a cable box to the Digital Media Recorder, the IR Control cable (G-LINK cable) must be connected to the back of your Digital Media Recorder and the other end of the cable (called a wand) must be placed in front of the remote sensor on the cable box in order for all of the features of the system to work.

Identify the channel you tune your TV to when using the cable box, and the brand of cable box. If your brand isn't listed, choose *Not Listed*.

After you've followed the on-screen instructions to enter the correct cable box information, the GUIDE Plus+ System performs a test to make sure it has received the appropriate information.

After the Digital Media Recorder completes its test, it gives you feedback. If the test failed, choose another brand or set it manually.

Note:

Since you must connect your cable box to your Digital Media Recorder instead of your TV, you'll need to tune the Digital Media Recorder to the cable box channel (usually either channel 2, 3, or 4) to watch TV programs.

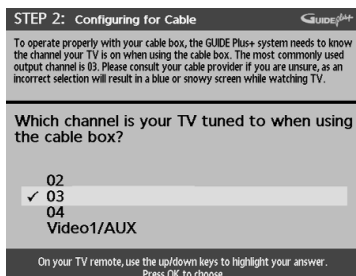
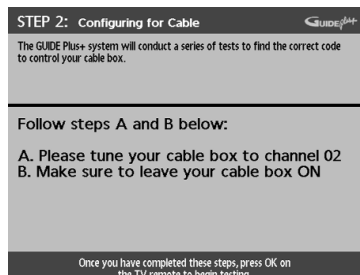

Chapter 1: Connections and Setup

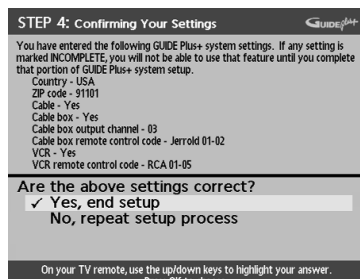

3d. Confirming Your Settings

Once you've finished the GUIDE Plus+ Setup, a screen appears listing the pertinent information you've given. Check to make sure all settings are complete and correct.

Note: If the cable box test failed, you should see *INCOMPLETE* next to the Cable Box category.

If all of the settings are accurate, highlight *Yes, end setup*, and press OK.

If any settings are incomplete or incorrect, highlight *No, repeat setup* process, and press OK. Follow the instructions on the screen to complete the setup.

➔ If you didn't connect a satellite receiver, go to step 5

➔ If you connected a satellite receiver, go to step 4

4) Satellite Receiver

If you connected a satellite receiver to the Digital Media Recorder, the IR Control cable must be connected to the back of your Digital Media Recorder (IR SAT) and the other end of the cable must be placed in front of the remote sensor on the satellite receiver in order for the Digital Media Recorder to control the satellite receiver for Timer Recordings.

Follow the on-screen instructions to select your satellite receiver brand. If your brand isn't listed, highlight *Not Listed*.

After you complete the on-screen satellite receiver setup, the Digital Media Recorder will perform a box test – follow the on-screen instructions.

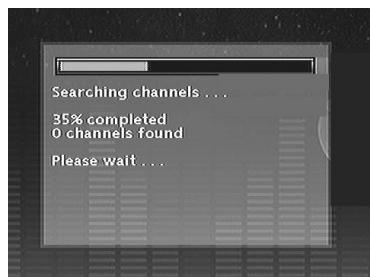

5) Channel Search

The Digital Media Recorder automatically scans the signal coming through the cable connected to the RF ANTENNA/CABLE INPUT or the INPUT jacks, and prepares the channel list. The channel list determines what channels appear when you press the channel up and down buttons.

A progress indicator appears on the TV screen. When the Channel Search reaches 100%, press OK (the Channel List appears)

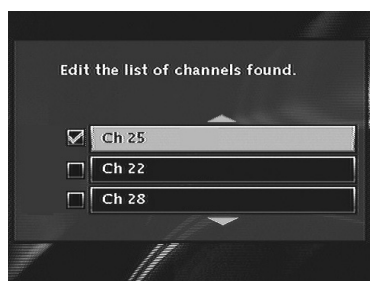

6) Channel List

The Channel List contains the channels you tune to when you press the CH+ and CH- (channel up and channel down) buttons on the remote control. From the Channel List screen, you can delete channels you rarely watch. You'll still be able to tune to the channels directly by using the number buttons on the remote control, but the Digital Media Recorder won't tune to a channel you delete when you press the channel up and/or down buttons on the remote control.

Press the down arrow button to scroll through the channels. A checkmark in the box next to the channel means it has been stored in the channel list. Follow the on-screen instructions to delete a channel in the list, or add one that isn't in the list. You can also label channels by pressing the INFO button.

To skip editing the channel list, press the right arrow button.

7) Time and Date

You must set up the clock accurately in order for Timer Recordings to work.

Use the number buttons on the remote to enter *Year*, *Date*, and *Time*. To change the AM/PM setting when you're entering the Time, press the right arrow button.

Note: If this screen doesn't appear, you can set the time later from the main menu— with the remote in DVD mode, press MENU, select *Setup*, select *Installation*, select *Manual Clock* and follow the on-screen instructions.

Watch TV

When the set-up procedure is complete, the main menu appears with the *Channels* menu highlighted. To watch TV, just press the OK button on the remote.

What to Expect

Since this technology integrates a hard disk drive into a DVD Player, and it is connected to your TV, you might experience some things that you're not used to.

Turn on the Digital Media Recorder to Watch TV

In order to use the features of the Digital Media Recorder (i.e., pausing live TV and/or recording programs to the hard disk drive), you'll have to get used to turning on your Digital Media Recorder to watch TV. You also need to tune the TV to the appropriate Video Input Channel – instead of changing channels with the TV's channel up and channel down buttons, you change channels via the Digital Media Recorder's channel up and down buttons and the TV stays on the Video Input Channel that corresponds to the Input Jacks on the TV you used to connect the TV to the Digital Media Recorder. If you need help finding the TV's Video Input Channel, go to page 16.

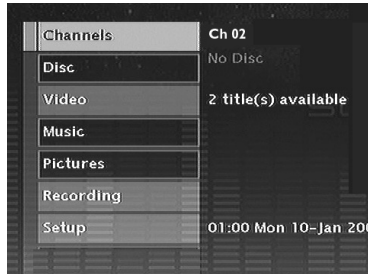

The main menu appears when you turn on the Digital Media Recorder. To watch TV, press OK when the *Channels* menu is highlighted. To see the GUIDE Plus+ System, press the GUIDE button.

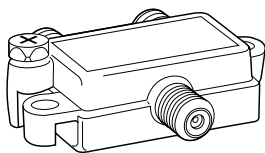

In order to watch one channel while you record another, you must connect the 2 Way Splitter correctly and change channels via the TV instead of the Digital Media Recorder. Operation with cable boxes varies.

The Main Menu Appears

The main menu appears whenever you turn on the Digital Media Recorder. To watch TV, press the OK button when the *Channels* menu is highlighted.

Slower Channel Change

When you change channels, you might notice that it takes longer than you're used to. This is perfectly normal and happens because the TV signal is going to the Digital Media Recorder and then back to the TV. This type of "signal flow" is the technology that enables you to record programming to the Recorder's hard disk drive and pause live TV.

You can't change channels while recording if you want to record one TV program while you watch another TV program

A 2 Way Splitter is packed with this product. Connected properly, this splitter enables you to watch one program while you record another. The connections provided show this 2 Way Splitter because you must use it if you want to record a program to the hard disk drive and watch another program that is being broadcast on TV at the same time.

When you're recording one program and watching a different program, you can't change channels via the Digital Media Recorder. You must change the channel on the TV (via the TV's remote control; the channel buttons on the TV; or using the remote packed with the Digital Media Recorder* provided you program the remote to operate the TV and put the remote in TV mode by pressing the TV button).

Notes:

If you have a cable box, you might not be able to record premium program stations to the Digital Media Recorder when using the 2 way splitter. Consult your cable company and/or cable box manual for help.

If you have a **digital cable box**, you must purchase a special digital splitter because the one provided is for regular, analog cable boxes only.



To see program listings, press the GUIDE button on the remote control.

The first time you access the GUIDE Plus+ system, the programs might not be listed yet. The program information has to be downloaded and is usually sent at night.

The GUIDE Plus+ Program Guide

The GUIDE Plus+ system is a no-fee, on-screen programming guide that lists TV schedules for your area (cable programming and/or off-air broadcasts only). To see the GUIDE Plus+ System programming guide, press the GUIDE button on the remote control.

The GUIDE Plus+ System is not available until it completes its first download of program information. Program information is usually sent at night. To ensure that your first download of data is complete, leave your Digital Media Recorder off overnight but it must remain plugged into a working AC outlet. If you use a cable box, be sure to leave it on. Downloads occur several times a day.

Note: the GUIDE Plus+ system doesn't list satellite programming.

*The Universal Remote Control packed with the Digital Media Recorder operates most RCA, GE, Proscan, and Scenium TVs. It is also capable of being programmed to operate many other brands and models. Go to page 19 for more information.

Chapter 1: Connections and Setup

How to find your TV's Video Input Channel

In order to see what's playing on your DVD Player, you need to tune the TV to the Video Input Channel that corresponds to the Input Jacks on your TV that you used to connect the Digital Media Recorder to the TV. The Video Input Channel(s) varies for different brands and different models of TVs.

RCA, GE, and Proscan TVs

If your brand of TV is RCA, GE, or Proscan, the remote control packed with your Digital Media Recorder will most likely access the TV's Video Input Channel— with the Digital Media Recorder turned on, press the TV button, and then press INPUT until you see the Digital Media Recorder's menu on your TV screen.

Other Brands of TVs

Since access to a TV's Video Input Channel varies from one manufacturer to the next, it's difficult to provide specific instructions for your particular brand. Below is a list of suggestions.

- Consult the Instruction Manual that came with your TV.
- If you can't find the information in the manual, or can't find the manual, review the following list.
 - There might be a button on the TV's remote control that accesses the Video Input Channel (see table below for examples).
 - You might select the Video Input Channel from the TV's menu system.
 - You might tune to it by pressing a specific channel number (see table below)
 - Press the Channel up and/or down buttons on the TV's remote control (sometimes the Video Input Channel is stored in your TV's channel list).

Video Input Channel Variations				
<u>Button/Switch on the TV</u>	<u>Button on the TV remote</u>		<u>Channel Number</u>	
VIDEO	VID1	S-VID	00	93
SIGNAL	LINE	INPUT	90	VID 1
VID 1	VID	SOURCE	91	VID 2
VID 2	VIDEO	AUX	92	INPUT

Next Steps

This chapter is dedicated to connecting your Digital Media Recorder. Choose what you want to do next, and go to the appropriate chapter for instructions.

Chapter 2: The Remote Control (page 17)

This product comes with a Universal Remote Control that can be programmed to operate your other components (VCR, satellite receiver, etc.). Go to page 19 for instructions.

Chapter 3: Using the Digital Media Recorder's Features (page 23)

This chapter tells you how to pause live TV; record programs onto the hard disk drive; copy music to the hard disk drive; transfer pictures (JPEG files) from a disc to the hard disk drive; and how to use the GUIDE Plus+ System programming guide.

Chapter 4: Playing Discs (page 31)

If you're ready to pop in a DVD (or a CD), this chapter explains how different discs function in the Digital Media Recorder and describes the features you can use with different types of discs.

Chapter 5: The Digital Media Recorder's Menu System (page 41)

Since this product is multi-functional, there are many on-screen menus to control settings and access features. Chapter 5 describes the menus and why you would want to use them.

Chapter 6: Additional Information (page 49)

If you're having trouble, go to Chapter 6. It includes troubleshooting information, the product's warranty, accessories you might want to purchase, and an overview of the jacks and controls on the front and back of the Digital Media Recorder.

Chapter 2

The Remote Control

- Explanation of the buttons
- Find out if the remote can operate your TV
- Programming the remote to operate your TV
- Programming the remote to operate other components

Graphics contained within this User's Guide are for representation only. Some of the menu screens, buttons, and display messages might be different in your product than they appear in this book. The on-screen help text provides the most current operational information.

Chapter 2: The Remote Control

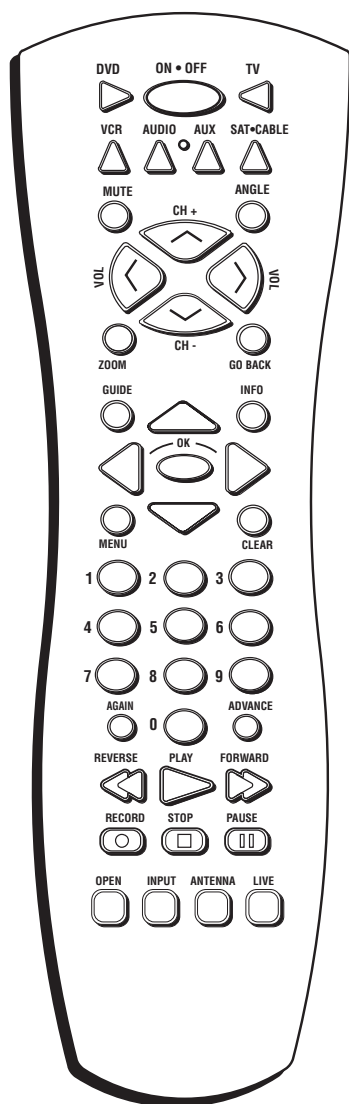

The Universal Remote Control that came with your Digital Media Recorder operates most RCA, GE, and Proscan branded components.

Additionally, the remote is capable of being programmed to operate many other brands and models of consumer electronics components such as satellite receivers, TVs, VCRs, etc.

Explanation of Buttons

You can use this remote to operate the Digital Media Recorder, and to access the features available. The remote is also designed to operate most RCA, GE, and Proscan components (TVs, VCRs, and satellite receivers). If you have another brand, you can program the remote control to operate those components (go to page 19 for instructions).

The descriptions that follow, describe how each button works when operating the Digital Media Recorder.

0-9 (Number buttons) Use the number buttons to input information such as chapter numbers, track numbers, to make selections on some menu screens, and/or to change channels.

Arrow buttons (up, down, left, right) Use the arrow buttons to highlight options that appear on the screen (the arrow buttons move the highlight in the corresponding directions – up arrow moves the highlight up; left arrow moves the highlight left, etc.).

ADVANCE Moves forward approximately 30 seconds.

AGAIN Accesses the Scene Again™ feature – replays the last several seconds (approximately 10) of the DVD disc you're playing or the program you're watching.

ANGLE Accesses various camera angles that might have been added to the disc when it was created. Only available for DVD discs, not for TV viewing or other discs.

Note: Currently, very few movies provide multiple camera angles.

ANTENNA In VCR mode, functions as a TV/VCR button. In SAT•CABLE mode, functions as a Satellite/Receiver button.

AUDIO Must be programmed in order to operate some brands and types of audio equipment.

AUX Program a second TV, VCR, satellite receiver, or cable box to this button.

CH + Goes to the next channel in the channel list. Advances to the next chapter or track when you're playing discs.

CH - Goes to the previous channel in the channel list. Goes back to the preceding chapter or track when you're playing a disc.

CLEAR Removes on-screen menus and displays.

DVD Puts the remote in DVD mode so it operates the Digital Media Recorder.

FORWARD Searches forward through the disc.

GO BACK Returns you to the previous menu. In TV mode, goes back to the previous channel.

GUIDE Accesses the GUIDE Plus+ system.

INFO Displays the on-screen Info Display (for details about the Info Display, go to page 34.)

INPUT Accesses the Input Jacks on the Recorder (RF ANTENNA/CABLE INPUT, INPUT 1, and INPUT 2 on the front of the Digital Media Recorder).

LIVE Goes to Live TV.

MENU When you're not playing a disc, accesses the Digital Media Recorder's menu. When you're playing a disc, accesses the disc's menu (disc guide) if one is available.

MUTE Lowers the volume to its minimum level. Press again to restore volume.

OPEN Opens and closes the disc tray.

OK When a menu is on the screen, selects the highlighted item.

ON•OFF Turns the Digital Media Recorder on and off.

PAUSE Pauses disc play or live TV broadcast

PLAY Begins disc play. If you've paused live TV, begins playback of the program you paused.

RECORD Records programming to the hard disk drive.

REVERSE Searches backward through the disc.

SAT•CABLE Puts the remote in Satellite or Cable mode in order for the remote to operate a satellite receiver or cable box. This remote is capable of being programmed to operate most brands of satellite receivers and cable boxes. This remote is already programmed to operate RCA, GE, and Proscan brand satellite receivers.

STOP Stops playback or recording.

TV Puts the remote in TV mode in order for it to operate your TV. This remote is already programmed to operate RCA, GE, and Proscan brand satellite receivers. This remote is capable of being programmed to operate many brands of TVs.

VCR Puts the remote in VCR mode. This remote is capable of being programmed to operate many brands of VCRs. This remote is already programmed to operate RCA, GE, and Proscan brand VCRs.

VOL >/< If your remote is capable of operating your TV, increases and decreases the volume level.

ZOOM Enlarges the image on the screen so you can zoom in on details. To pan and scan after you've zoomed in on an image, use the arrow buttons. The Zoom feature isn't available on all discs. Typically, it works with DVD discs and CDs with JPEG files.

Find out if the remote can operate your TV

This remote control is designed to operate most RCA, GE, and Proscan TVs.

1. Press the TV button.
2. Press the ON•OFF button (if the TV turns on or off, this remote will operate the TV).
3. If that doesn't work, you can try programming the remote by following the instructions below.

Programming the Remote to Operate your TV

The remote can be programmed to control many brands and models of remote controllable TVs.

1. Turn on the TV.
2. Look up the brand and code number(s) from the list on page 20.
3. Press and hold the TV button on the remote.
4. Keep holding down the TV button, and enter the first code from the code list for your brand.
5. Release the TV button.
6. Point the remote toward the TV and press the ON•OFF button to see if the TV turns off. If it doesn't, press the TV button and then press ON•OFF. If you get no response, follow steps 1-4 again, but enter the next code from the code list for your brand of television.

Note: This remote may not be compatible with all brands and models of televisions.

Programming the remote to operate other components (VCR, satellite receiver, etc.)

This remote is already programmed to operate most RCA, GE, and Proscan VCRs and satellite receivers – just press the corresponding button (i.e., VCR button for VCR, SAT•CABLE button for a satellite receiver). If you have other brands, follow the instructions for Programming the Remote to Operate Your TV, but press the component button that applies to the component (i.e., VCR button for VCR; SAT•CABLE for a cable box or satellite receiver).

Note: The AUX button can be programmed to operate an additional TV, VCR, or SAT•CABLE box. The AUDIO button can only be programmed to operate some audio devices.

Chapter 2: The Remote Control

Television Codes

Abex	1172
Admiral	1001, 1173, 1211
Adventura	1174
Aiko	1016
Akai	1002
Alleron	1046
Amtron	1038
Anam National	1003, 1038, 1192, 1193, 1194
AOC	1004, 1005, 1006, 1007, 1175, 1176, 1195
Audiovox	1038
Belcor	1004
Bell & Howell	1001, 1083, 1162
Bradford	1038
Brokwood	1004
Candle	1004, 1006, 1008, 1174
Celebrity	1002
Centurion	1009
Citizen	1004, 1006, 1008, 1016, 1038, 1105, 1171, 1174, 1177
Colortyme	1004, 1006, 1010
Concerto	1004, 1006
Contec/Cony	1012, 1013, 1014, 1038
Craig	1038
Crown	1038, 1171
Curtis Mathes	1000, 1004, 1006, 1015, 1105, 1162, 1171, 1212
CXC	1038
Daewoo	1004, 1005, 1006, 1016, 1017, 1018, 1127, 1171, 1196
Daytron	1004, 1006, 1171
Dimensia	1000
Dumont	1004, 1151
Electroband	1002
Electrohome	1003, 1004, 1006, 1019, 1020, 1022
Emerson	1004, 1006, 1012, 1023, 1024, 1025, 1026, 1027, 1028, 1029, 1030, 1031, 1032, 1033, 1034, 1035, 1036, 1037, 1038, 1039, 1041, 1042, 1043, 1044, 1046, 1047, 1123, 1124, 1162, 1171, 1177, 1179, 1191, 1208
Envision	1004, 1006
Fisher	1048, 1049, 1051, 1162, 1180
Fujitso	1046
Funai	1038, 1046
Futuretec	1038
GE	1000, 1003, 1004, 1006, 1022, 1052, 1054, 1055, 1087, 1164, 1165, 1166, 1167, 1168, 1181, 1213
Gibraltar	1004, 1151
Goldstar	1004, 1005, 1006, 1012, 1019, 1056, 1057, 1058, 1155, 1156, 1171, 1172
Grundy	1038, 1046, 1171
Hallmark	1004, 1006
Harvard	1038
Hitachi	1004, 1006, 1012, 1013, 1014, 1059, 1060, 1061, 1135, 1136, 1137, 1138, 1139, 1140, 1141, 1142, 1143, 1144, 1145, 1146, 1148, 1150, 1179, 1198, 1199
IMA	1038
Infinity	1062
JCPenney	1000, 1004, 1005, 1006, 1008, 1022, 1052, 1054, 1058, 1063, 1064, 1072, 1087, 1105, 1128, 1171, 1172, 1181, 1201
Janeil	1174
JBL	1062
JCB	1002
Jensen	1004, 1006
JVC	1012, 1013, 1014, 1054, 1060, 1065, 1066, 1067, 1157, 1158, 1159, 1182
Kawasho	1002, 1004, 1006
Kenwood	1004, 1006, 1019
Kloss Novabeam	1068, 1069, 1174, 1183
KTV	1038, 1070, 1171, 1177
Loewe	1062
Logik	1083
Luxman	1004, 1006
LXI	1000, 1006, 1049, 1062, 1071, 1072, 1073, 1162, 1181, 1207, 1088, 1130, 1131, 1132, 1133, 1134, 1183, 1219, 1235
Magnavox	1004, 1006, 1008, 1019, 1062, 1068, 1069, 1075, 1076, 1077, 1088, 1130, 1131, 1132, 1133, 1134, 1183, 1219, 1235
Majestic	1083
Marants	1062
Marantz	1004, 1006, 1062, 1078
Megatron	1006, 1059
Memorex	1001, 1006, 1082, 1083, 1162
MGA	1004, 1005, 1006, 1019, 1022, 1051, 1079, 1080, 1082
Midland	1054, 1151, 1171, 1172, 1181
Mitisubishi	1004, 1005, 1006, 1019, 1022, 1051, 1079, 1080, 1081, 1082, 1125
Minutz	1052
Montgomery Ward	1083
Motorola	1003, 1173
MTC	1004, 1005, 1006, 1105
Multitech	1038
Multivision	1084
NAD	1006, 1071, 1072, 1185
NEC	1003, 1004, 1005, 1006, 1200
Nikko	1006, 1016
NTC	1016
Onwa	1038
Optimus	1185
Optonica	1095, 1173
Orion	1035, 1191
Panasonic	1003, 1054, 1062, 1170, 1214
Philco	1003, 1004, 1005, 1006, 1008, 1012, 1019, 1062, 1068, 1069, 1075, 1077, 1183
Philips	1003, 1004, 1008, 1012, 1019, 1062, 1068, 1069, 1075, 1076, 1086, 1087, 1088, 1089
Pilot	1004, 1171
Pioneer	1004, 1006, 1090, 1091, 1092, 1179, 1185
Portland	1004, 1005, 1006, 1016, 1171
Price Club	1105
Prism	1054
Proscan	1000, 1181
Proton	1004, 1006, 1012, 1093
Pulsar	1004, 1151
Quasar	1003, 1054, 1070, 1094
Radio Shack/Realistic	1000, 1004, 1006, 1012, 1038, 1049, 1095, 1162, 1171, 1172
RCA	1000, 1003, 1004, 1005, 1006, 1007, 1019, 1096, 1098, 1099, 1100, 1101, 1102, 1103, 1129, 1179, 1181, 1187, 1188, 1190, 1202, 1203, 1215, 1233
Runco	1151
Sampo	1004, 1006, 1171, 1172
Samsung	1004, 1005, 1006, 1012, 1015, 1019, 1104, 1105, 1106, 1171, 1172, 1204
Samsux	1171
Sansui	1191
Sanyo	1004, 1048, 1049, 1080, 1107, 1108, 1162, 1169, 1180
Scotch	1006
Scott	1004, 1006, 1012, 1024, 1035, 1038, 1046
Sears	1000, 1004, 1006, 1013, 1014, 1019, 1046, 1048, 1049, 1051, 1066, 1071, 1072, 1109, 1110, 1162, 1180, 1181, 1189
Sharp	1004, 1006, 1012, 1029, 1095, 1111, 1112, 1113, 1122, 1171, 1173
Shogun	1004
Signature	1001, 1083, 1115
Simpson	1008
Sony	1002, 1205, 1216, 1218
Soundesign	1004, 1006, 1008, 1038, 1046
Squareview	1189
SSS	1004, 1038
Starlite	1038
Supre-Macy	1174
Supreme	1002
Sylvania	1004, 1006, 1008, 1019, 1062, 1068, 1069, 1075, 1076, 1077, 1088, 1116, 1161, 1183
Symphonic	1033, 1038, 1189
Tandy	1173
Tatung	1003

Technics1054
 Techwood1004, 1006, 1054
 Teknika1004, 1005, 1006, 1008, 1012, 1013, 1014, 1016, 1038, 1046,
 1076, 1082, 1083, 1105, 1170, 1171
 Telecaption1117
 TMK1004, 1006
 Toshiba1049, 1071, 1072, 1105, 1109, 1117, 1118, 1160, 1162
 Totevision1171
 Universal1052, 1087
 Victor1066, 1182
 Vidtech1004, 1005, 1006
 Viking1174
 Wards1000, 1001, 1004, 1005, 1006, 1019, 1024, 1033, 1046, 1052,
 1062, 1068, 1069, 1075, 1076, 1083, 1087, 1088, 1095, 1119, 1120
 Yamaha1004, 1005, 1006, 1019
 Zenith1004, 1083, 1151, 1152, 1153, 1154, 1210, 1217

VCR Codes

Admiral2132
 Adventura2026
 Aiko2027
 Aiwa2026
 Akai2003, 2004, 2005, 2007, 2008, 2111, 2112, 2113
 American High2021
 Asha2013
 Audio Dynamics2009, 2010
 Audiovox2014
 Beaumark2013
 Bell & Howell2011
 Broksonic2012, 2025
 Calix2014
 Candle2013, 2014, 2015, 2016, 2017, 2018, 2019
 Canon2021, 2022, 2114
 Capehart2020, 2110
 Carver2062
 CCE2027, 2061
 Citizen2013, 2014, 2015, 2016, 2017, 2018, 2019, 2027
 Colortyme2009
 Colt2061
 Craig2013, 2014, 2023, 2061
 Curtis Mathes2000, 2009, 2013, 2016, 2018, 2021, 2022, 2024, 2115, 2131
 Cybernex2013
 Daewoo2015, 2017, 2019, 2025, 2026, 2027, 2028, 2110
 Daytron2110
 DBX2009, 2010
 Dimensia2000, 2131
 Dynatech2026
 Electrohome2014, 2029
 Electrophonic2014
 Emerson2012, 2014, 2015, 2021, 2024, 2025, 2026, 2029, 2030, 2031,
 2032, 2033, 2034, 2035, 2036, 2037, 2038, 2039, 2040, 2041, 2042, 2044, 2045, 2046,
 2047, 2065, 2113, 2116, 2117, 2130
 Fisher2011, 2023, 2048, 2049, 2050, 2051, 2052, 2118
 Fuji2021, 2119
 Funai2026
 Garrard2026
 GE2000 (VCR1), 2001 (VCR2), 2013, 2021, 2022, 2053, 2115, 2120,
 2131
 Goldstar2009, 2014, 2018, 2054
 Gradiente2026
 Harley Davidson2026
 Harman Kardon2009
 Harwood2061
 Headquarter2011
 Hi-Q2023
 Hitachi2055, 2056, 2057, 2107, 2111, 2120, 2122
 Instant Replay2021

JCPenney2009, 2010, 2011, 2013, 2014, 2021, 2022, 2055, 2056, 2058,
 2059, 2060, 2107, 2118
 JCL2021
 Jensen2055, 2056, 2111
 JVC2009, 2010, 2011, 2018, 2111, 2123
 Kenwood2009, 2010, 2011, 2016, 2018, 2111, 2123
 KLH2061
 Kodak2014, 2021
 Lloyd2026
 Logik2061
 LXI2014
 Magnavox2021, 2022, 2062, 2063, 2104, 2105, 2108, 2124
 Magnin2013
 Marantz2009, 2010, 2011, 2016, 2018, 2021, 2062, 2064
 Marta2014
 Masushita2021
 MEI2021
 Memorex2011, 2013, 2014, 2021, 2023, 2026, 2104, 2132
 MGA2029, 2065, 2113
 MGN Technology2013
 Midland2053
 Minolta2055, 2056, 2107
 Mitsubishi2029, 2055, 2056, 2065, 2066, 2067, 2068, 2069, 2070, 2071,
 2072, 2073, 2074, 2106, 2113, 2123
 Montgomery Ward ...2075, 2132
 Motorola2021, 2132
 MTC2013, 2126
 Multitech2013, 2016, 2026, 2053, 2061
 NEC2009, 2010, 2011, 2016, 2018, 2064, 2076, 2078, 2079, 2111,
 2123
 Nikko2014
 Noblex2013
 Olympus2021
 Optimus2014, 2132
 Optonica2096
 Panasonic2021, 2022, 2109, 2125, 2126, 2127
 Pentax2016, 2055, 2056, 2107, 2120
 Pentex Research2018
 Philco2021, 2022, 2062, 2063
 Philips2021, 2062, 2096, 2124
 Pilot2014
 Pioneer2010, 2055, 2080, 2081, 2123
 Portland2016, 2017, 2019, 2110
 Proscan2000 (VCR1), 2001 (VCR2), 2131
 Protec2061
 Pulsar2104
 Quarter2011
 Quartz2011
 Quasar2021, 2022, 2125
 Radio Shack/Realistic .2011, 2013, 2014, 2021, 2022, 2023, 2026, 2029, 2049, 2050,
 2096, 2132
 Radix2014
 Randex2014
 RCA2000 (VCR1), 2001 (VCR2), 2003, 2013, 2021, 2055, 2056,
 2082, 2083, 2084, 2085, 2086, 2087, 2088, 2089, 2090, 2091, 2107, 2115, 2120, 2125,
 2131, 2133
 Ricoh2128
 Runco2104
 Samsung2005, 2013, 2015, 2033, 2053, 2112
 Sanky2104, 2132
 Sansui2010, 2092, 2111, 2123
 Sanyo2011, 2013, 2023
 Scott2012, 2015, 2025, 2032, 2038, 2065, 2093, 2116
 Sears2011, 2014, 2021, 2023, 2048, 2049, 2050, 2051, 2055, 2056,
 2107, 2118
 Sharp2017, 2029, 2094, 2095, 2096, 2097, 2132
 Shintom2004, 2056, 2061, 2098
 Shogun2013

Chapter 2: Remote Control

VCR Codes (continued)

Signature	.2132
Singer	.2021, 2061, 2128
Sony	.2004, 2098, 2099, 2119
STS	.2021, 2107
Sylvania	.2021, 2022, 2026, 2062, 2063, 2065, 2124
Symphonic	.2026
Tandy	.2011
Tashiko	.2014
Tatung	.2111
Teac	.2026, 2085, 2111
Technics	.2021, 2109
Teknika	.2014, 2021, 2026, 2100, 2129
TMK	.2013, 2024, 2047
Toshiba	.2015, 2049, 2051, 2055, 2065, 2093, 2116
Totevision	.2013, 2014
Unitech	.2013
Vector Research	.2009, 2010, 2015, 2016
Victor	.2010
Video Concepts	.2009, 2010, 2015, 2016, 2113
Videosonic	.2013
Wards	.2013, 2014, 2015, 2021, 2023, 2026, 2029, 2055, 2056, 2061, 2096, 2101, 2102, 2103, 2107, 2116, 2132
XR-1000	.2021, 2026, 2061
Yamaha	.2009, 2010, 2011, 2018, 2111
Zenith	.2004, 2098, 2104, 2119, 2128

Audio Receivers (RCA and Dimensia)

RCA and Dimensia

AM/FM	.4003, 4270
Aux	.4004
CD	.4007, 4190, 4211
Phono	.4005
Tape	.4006
Aiwa	.4261, 4262, 4263, 4264, 4265, 4266, 4267, 4277
Denon	.4283
Harmon Kardon	.4276
JVC	.4268
JVL	.4276
Kenwood	.4269
Onkyo	.4278
Optimus	.4284
Panasonic	.4279, 4280
Pioneer	.4275
RCA	.4270
Sherwood	.4282
Sony	.4271, 4272, 4281
Technics	.4279, 4280
Wards	.4275
Yamaha	.4274, 4275

Cable Box

ABC	.5002, 5003, 5004, 5006, 5053
Antronix	.5008, 5009
Archer	.5008, 5009, 5010
Cabletenna	.5008
Cableview	.5008
Colour Voice	.5012, 5013
Comtronic	.5014
Contec	.5016
Eastern	.5017
GC Electronics	.5009
GE	.5000, 5001
Gemini	.5018, 5019
General Instrument	.5003
Hamlin	.5020, 5021, 5022, 5028, 5035, 5045
Hitachi	.5003
Jerrold	.5003, 5018, 5023, 5024, 5046, 5053
Magnavox	.5025
Memorex	.5026
Movie Time	.5027
NEC	.5005
NSC	.5027
Oak	.5016, 5029
Panasonic	.5048, 5052
Philips	.5011, 5012, 5013, 5015, 5019, 5025, 5030, 5031, 5032
Pioneer	.5033, 5034
Proscan	.5000, 5001
RCA	.5007, 5047, 5049, 5052
Realistic	.5009
Regal	.5022, 5035
Regency	.5017
Rembrandt	.5003
Samsung	.5034
Scientific Atlanta	.5006, 5036, 5037, 5038
Signal	.5018
Signature	.5003
Sprucer	.5052
Standard Components	.5039, 5044
Starcom	.5018, 5053
Stargate	.5018
Starquest	.5018
Tocom	.5004, 5023
Tusa	.5018
TV86	.5027
Unika	.5008, 5009
United Cable	.5053
Universal	.5008, 5009, 5010
Viewstar	.5025, 5027
Zenith	.5050, 5051

Satellite

Alphastar	.5079
Chapparral	.5056, 5057
Dishnet	.5078
Drake	.5058, 5059
Echostar	.5089
GE	.5000 (SAT1), 5001 (SAT2)
General Instruments	.5060, 5061, 5062
Hitachi	.5083, 5084
Hughes Network	.5077, 5090
JVC	.5082
Panasonic	.5075
Philips	.5085
Primestar	.5076
Proscan	.5000 (SAT1), 5001 (SAT2)
RCA	.5000 (SAT1), 5001 (SAT2), 5071, 5080, 5081
Realistic	.5063
Sony	.5072
STS1	.5064
STS2	.5065
STS3	.5066
STS4	.5067
Toshiba	.5068, 5073
Uniden	.5069, 5086

Chapter 3

Using the Recorder's Features

- **Watching TV**
- **Pausing TV**
- **Recording**
- **Playing content you've recorded**
- **The GUIDE Plus+ System**
- **Playback**
- **GUIDE Plus+ System**

Extra Info

The following list is provided to give you an idea of what you can do with the Digital Media Recorder, and when.

What you can do

Pause Live TV

Play discs (audio CDs; DVD discs; Video CDS, CDs with mp3 files, CDs with JPEG files).

Record Live TV

Play programs that you recorded to the hard disk drive

Play music or pictures that you've placed on the hard disk drive

Record a program to the hard disk drive while you're playing a disc

Record a program to the hard disk drive while you watch another program (dependent upon connection of 2 Way Splitter and the ability to split the signal that provides programming to your TV)

Record a program to the hard disk drive while you play another program from the hard disk drive

What you can't do

Record a program while you're pausing live TV*

Save a program to the hard disk drive once you've paused it.

Record copyrighted, production DVD movies to the hard disk drive

Simultaneously record programs/content to the Digital Media Recorder's hard disk drive from two channels or sources

Watch, playback, record, or pause TV while you're copying JPEG files or music (mp3 files) to the hard disk drive (the length of time that it takes to transfer this kind of content varies).

* Applicable only if you're recording a different program than the one you're watching.

Graphics contained within this User's Guide are for representation only. Some of the menu screens, buttons, and display messages might be different in your product than they appear in this book. The on-screen help text provides the most current operational information.

Chapter 3: Using the Recorder's Features

Watching TV

Turn on the Digital Media Recorder to Watch TV

In order to use the Digital Media Recorder's features such as pausing live TV, the GUIDE Plus+ system's on-screen programming guide, and recording, you must watch TV with the Digital Media Recorder turned on and the TV tuned to the correct Video Input Channel.

1. Turn on the TV, and tune it to your Video Input Channel (this channel corresponds to the input jacks on your TV that you used to connect the Digital Media Recorder to the TV).
2. Turn on the Digital Media Recorder (the Digital Media Recorder's main menu appears).
3. Since the *Channels* menu is already highlighted, just press the OK button on the remote (the Digital Media Recorder tunes to the last station you watched and a channel banner appears). The channel banner provides information about the channel and you can change the audio setting. To see the channel banner after it disappears from the screen, press INFO on the remote control.

Note: When you change channels, you might notice a delay. This is perfectly normal because the programming must pass through the Digital Media Recorder before it appears on the TV screen.

Pausing Live TV

Since your Digital Media Recorder has a hard disk drive, you can essentially pause a program that's being broadcast and start watching it again when it's convenient for you. You can pause up to 45 minutes of programming.

1. The Digital Media Recorder must be on while watching TV (see instructions above).
2. Press PAUSE.
3. When you're ready to watch the program, press PLAY and the program starts playing from the place you left off. While you're watching the program, you can fast forward through commercials by pressing the ADVANCE button. When you want to return to regular TV broadcasting time (live TV), press the LIVE button on the remote.

Notes:

If you've paused live TV, you must watch the program continuously – you can't change channels and then come back later because the hard disk drive records the signal continuously (i.e., if you pause channel 13 for 5 minutes, change to channel 6 and watch it for 15 minutes; that is exactly what is stored on the hard disk drive – the 5 minutes of channel 13 you paused and the 15 minutes of channel 6).

Once a program is paused, you can't save it to the hard disk drive because it is stored in a different section of the hard disk drive.

Features might work differently if you use a cable box for programming.

Each time you access the *Channels* menu from the main menu, the hard disk drive's memory is reset. The memory is the part of the hard disk drive that continuously records the broadcast signal (up to 45 minutes) enabling you to pause live TV and play it back later.

Recording

There are several ways to record programming. The quickest way is to press the RECORD button while you're watching a show (the recording banner appears). You don't even need to remember to press the stop button when you're finished recording if you use the Express Recording feature in the recording banner.

Express Recording Feature

Each time you press the RECORD button on the remote the recording time increases by 30 minutes, up to the maximum limit (the status is listed on the recording banner).

Stopping and/or Pausing a Recording

How you stop or pause a recording affects the way the program is listed in the Digital Media Recorder's *Video* menu— that's where the recorded programs are stored and how you access recorded programs to play them back.

To pause or stop recording, press the STOP button on the remote control (a screen appears with the following options: *No, don't stop recording*; *Yes, stop recording temporarily*; *Yes, stop recording*). If you want to start recording this program again and want it to appear in the *Video* menu as one continuous program, highlight *Yes, stop recording temporarily* – press the RECORD button when you're ready to start recording again – or *No, don't stop recording*.

If you choose *Yes, stop recording* the part of the program you recorded will appear as one program in the *Video* menu. If you start recording again, the next part of the program will appear as a separate program (or recording session).

Watching one channel while you record another channel to the Digital Media Recorder

If you want to watch another channel while you're recording, you need to make sure you've connected a 2 Way Splitter (go to page 4 for details), and do the following:

1. Make sure the Digital Media Recorder and the TV are on. Tune the TV to the appropriate Video Input Channel (if you need help, go to page 16).
2. Using the Digital Media Recorder's channel buttons, tune to the program you want to record. Press the RECORD button.
3. If the remote that came with your Digital Media Recorder operates your TV, just press the TV button and use the channel up and down buttons to go to a different channel.
If the remote doesn't operate your TV, use the TV's remote control to change channels.
4. When you're finished recording, remember to turn the TV back to its Video Input Channel and watch TV through the Digital Media Recorder.

Notes:
This feature might work differently if you receive programming via a cable box. If you receive programming via satellite receiver, this feature is only possible if you purchase a compatible, digital signal splitter.

The remote that came with your Digital Media Recorder is a programmable Universal remote that can be programmed to operate many brands and models of TVs. Go to page 19 if you want to program the remote).

You won't be able to pause live TV when you're recording one channel, and watching another channel.

Record continuously so the program will appear as one title in the Video menu.

Recording from the GUIDE Plus+ on-screen programming guide

You can schedule recordings from the GUIDE Plus+ on-screen programming guide (not available for satellite programming).

1. If the program guide isn't on the TV, press the GUIDE button on the remote control (the listings guide appears).
2. Use the remote control's arrow button to highlight the program you want to record.
3. Press the 3 button on the remote.
Note: The 3 button corresponds to the GUIDE Plus+ System's action buttons and says record next to it. DON'T press the RECORD button.
4. To change the frequency of the recording (one time, daily, weekly, etc.), go to the GUIDE Plus+ *Schedule* menu (see page 30 for more info).

Note:
If the recording you set up through the GUIDE Plus+ system conflicts with a timer recording that you set up via the Digital Media Recorder's *Recording* menu, the Timer recording you set up in the Digital Media Recorder's *Recording* menu system will be recorded instead of the one you scheduled through the GUIDE Plus+ system.

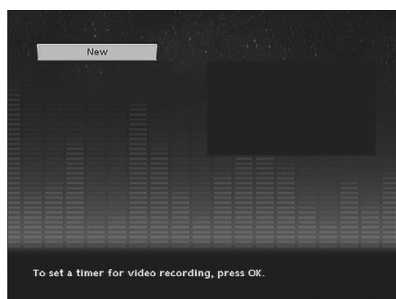

Setting up timer recordings to record programs automatically

1. From the Digital Media Recorder's main menu, use the remote's arrow buttons to highlight *Recording*, and press the OK button.
2. If necessary, highlight *Timer*, and press OK.
3. If necessary, highlight *New*, and press OK.
4. If you want to give the Timer a name, highlight *Name* and press the right arrow button (the on-screen keyboard appears – follow the on-screen instructions to name the timer). When finished entering the name, make sure you press the right arrow button to highlight *Done* and press OK.
5. Highlight the *Channel* field and use the number buttons on the remote to enter the channel number, and press OK.
6. Highlight *Day* and use the number buttons to enter month and day. To change the frequency (once, daily, weekly, etc.), press the right arrow button.
7. Use the number buttons to enter the time you want to start recording. Press the right arrow button to change the a.m./p.m. setting. Use the number buttons to enter the time you want the Digital Media Recorder to stop recording. Press the right arrow button to change a.m./p.m. setting.
8. You can change the quality of the recording by pressing the right arrow button. The better the quality, the more space the recording takes up on the Digital Media Recorder's hard disk drive—less recording time available (go to page 44 for more information). Press OK to confirm the quality recording setting.
9. When you're finished, press the down arrow button to highlight *Keep* and press the OK button.



Notes: The Digital Media Recorder's clock must be set in order for Timer Recordings to work properly. For more information about the One-Touch Record feature available via the GUIDE Plus+ System's Schedule menu, go to page 30.

Chapter 3: Using the Recorder's Features

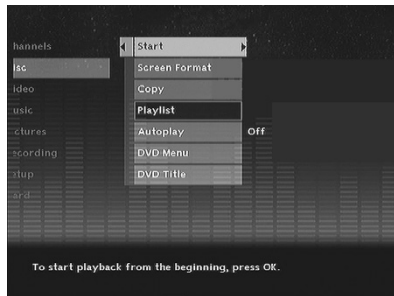

Copying music or pictures to the Digital Media Recorder

1. Place the disc in the Digital Media Recorder's disc tray.
Note: Make sure the disc contains the JPEG and mp3 files you want to save to the hard disk drive because you can't select individual files or folders – all JPEG files and mp3 files that are on the disc will be copied to the hard disk drive.
2. If the main menu isn't on the screen, press MENU on the remote control.
3. From the main menu, use the down arrow button on the remote to highlight *Disc*, and press OK (the Disc options appear).

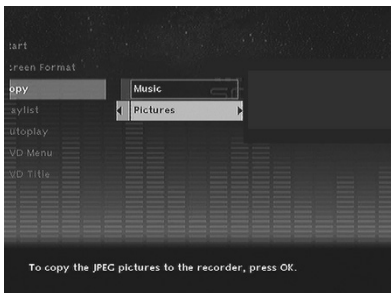

4. Highlight *Music* or *Pictures*, depending on which one you're copying.

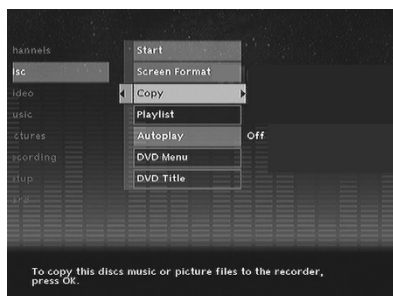

5. Highlight *Copy*, and press OK.

Note: While the files are being copied, you can't use the Digital Media Recorder. The amount of time it takes for the files to copy varies.

Only true mp3 files can be played and/or copied. Some mp3 players use software that converts mp3 files to other formats, such as MPX. Similarly, only JPEG files can be played and/or copied.

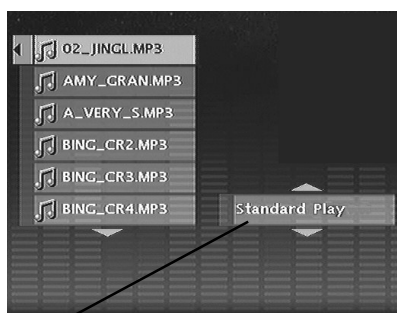

Renaming picture and/or music files

1. After you copy mp3 files, they're stored in the *Music* menu. JPEG files are stored in the *Pictures* menu. To rename a file, highlight it from the appropriate menu and then press the right arrow button to highlight the *Standard Play* box on the right of the screen.
2. Use the up and/or down arrow buttons to scroll through the choices and follow the on-screen instructions.

From the list of songs or pictures, press the right arrow button on the remote to highlight the *Standard Play* box. Press up and down arrow buttons until *Rename* appears and press OK.

Playback: Watch and/or listen to content that's stored on the Recorder's hard disk drive

Once you've recorded programs to your Digital Media Recorder, they will be saved on the Digital Media Recorder's hard disk drive.

Playing programs you've recorded

To play back shows you've recorded, do the following:

1. From the Digital Media Recorder's main menu (press the MENU button on the remote), use the arrow buttons on the remote to highlight *Video* and press the OK button (a list of programs that have been saved to the Digital Media Recorder appears).
Note: By default, the order the programs appear is newest to oldest. To change the order, press right arrow button to highlight the Standard Play box; press the ANGLE button on the remote (the oldest programs recorded appear at the top of the list). To see the programs in alphabetical order, press the ANGLE button again.
2. Use the up and down arrow buttons on the remote to highlight the show you want to play.
3. To watch the program, press PLAY. If you want to name the program, delete it, or change the play mode, press the right arrow button to highlight *Standard Play*. Once highlighted, use the up and down arrow buttons to scroll through choices.

Playing a program from the Video Menu while you record another program

1. Use the channel buttons on the remote to tune to the channel you want to record.
2. Press RECORD.
3. Press MENU (the main menu appears).
4. Highlight *Video* and press OK. Choose the program you want to watch by highlighting it and press PLAY.

Playing back music you've saved to the Digital Media Recorder's hard disk drive

Follow the instructions for "Playing programs you've recorded" (above), but choose *Music* from the main menu instead of *Video*. When you select *Music*, the files and folders appear. To open a folder, highlight it and press the OK button (the mp3 files in the folder appear). Press PLAY.

Notes:

For more information about playing mp3 files, go to page 39.

Only true mp3 files can be played and/or copied. Some mp3 players use software that converts mp3 files to other formats, such as MPX.

The Info Display isn't available for mp3 files.

Playing back Pictures (JPEG files) that you've saved to the hard disk drive

Follow the instructions for "Playing back programs you've recorded" (above), but choose *Pictures* from the main menu instead of *Video*.

When you select *Pictures*, the files and folders appear. To open a folder, highlight it and press the OK button (the JPEG files in the folder appear). Press PLAY

Notes:

JPEG files can be played and/or copied. However, if the file is large, it might not be displayed.

For more information about playing JPEG files, go to page 40.

Chapter 3: Using the Recorder's Features

Deleting Programs, Music and/or Pictures from the Digital Media Recorder

Your Digital Media Recorder has 40 GB of memory – which translates to approximately 40 hours of video programs, dependent upon the recording quality you've chosen; up to 10,000 JPEG files; or 1,000 mp3 files that can be saved onto the hard disk drive. You can see the status of the space left on the hard disk drive in the *Video* menu. The information is only an approximation based on current Recording Quality setting (page 44). When you want to delete programs, music, or pictures to make more space available, follow the instructions below:

1. From the main menu, select the menu that corresponds to the content you want to delete (*Video*, *Music*, or *Pictures*), and press the OK button.
2. Use the arrow buttons on the remote control to highlight a video program, mp3 song, or JPEG picture.
3. Press the right arrow button to highlight the box to the right of the content list (it has arrows at the top and bottom to indicate that you can see choices by pressing up and down arrow buttons on the remote control).
4. Press the down arrow button until *Delete* appears. Press OK (a screen appears asking you to confirm that you want to delete the program).

Saving Program, Music, and/or Pictures from the Digital Media Recorder to a VCR

If your hard disk drive is full, you can always connect it to your VCR's Input Jacks and copy the content onto a videocassette. For instructions, go to page 60.



About GUIDE Plus+ System Program Guide

The GUIDE Plus+ system is a no-fee, on-screen, program guide that lists TV schedules for your area and allows your Digital Media Recorder direct control of a cable box. The GUIDE Plus+ system doesn't list satellite programming.

There are six sections of the GUIDE Plus+ system:

- Action buttons at the top of the screen (1, 2, 3)
- A video window
- Program information
- A row of on-screen menu options (Listings, Sort, News, Messages, Promotions, Schedule, and Setup,)
- Channel listings
- Promotional information

Notes:

The GUIDE Plus+ system screens illustrated in this book are representations of what you are likely to see. Not all channels, programs, and GUIDE Plus+ information depicted will be available in your area.

New features and options can be downloaded to the GUIDE Plus+ system, so these are subject to change also.

The GUIDE Plus+ system doesn't display program listings for satellite TV. If you receive programming through satellite TV service, your Digital Media Recorder's Guide Plus+ System won't work.

Using the GUIDE Plus+ System

To enter the GUIDE Plus+ system:

- Press the GUIDE button on the remote control.

To exit the GUIDE Plus+ System:

- Highlight a program and press OK to exit the GUIDE Plus+ system and tune to the program (channel).
- Press GUIDE to exit the GUIDE Plus+ system and tune to the program (channel) displayed in the video window.
- Press CLEAR to exit the GUIDE Plus+ system and return to the original channel.



GUIDE Plus+ System menu bar

The GUIDE Plus+ System Menu Bar

The GUIDE Plus+ system offers eight different options on the menu bar: *Listings*, *Sort*, *News*, *Messages*, *Promotions*, *Schedule*, and *Setup*. To access the Menu bar:

1. Press the GUIDE button (the GUIDE Plus+ programming guide appears).
2. To highlight the Menu bar items, press MENU or press the up arrow button (the *Listings* Guide appears by default).
3. Use the left and right arrow buttons to access other menus in the Menu bar.



Listings Guide

The Listings Guide appears each time you enter the GUIDE Plus+ system. It displays the current programming for each channel. The current program is displayed in the video window.

- Press the up and down arrow buttons on the remote to browse channel listings one at a time and the channel up and down buttons to browse channel listings a page at a time. Use the right arrow button to browse future program listings.
- To tune to a channel, highlight the program you want to watch in the channel listing and press OK. To exit the GUIDE Plus+ system and return to the original channel, press the CLEAR button. To tune to the channel that is displayed in the video window, press the GUIDE button.

Locking the Video Window

By default, the video window changes when you highlight different programs. If you want the video to stay on the same channel while you surf the Listings Guide, use the left arrow button to highlight the channel name or logo (the left column on the channel listing), and press 1 (lock).

Action buttons



Grid Guide Action Buttons

The Action buttons change according to where you are in the GUIDE Plus+ system. Be sure to look at the action bar before pressing any of the command numbers.

When a program is highlighted, the following Action buttons appear:

- **Watch** Press 1 on the remote control to place a timer into the Schedule so the TV will turn on and tune to the program highlighted in the channel listing.
- **Go To** Press 2 on the remote to bring up the direct dial box and enter the number of the channel you want.
- **Record** Press 3 on the remote to place a timer in the Schedule so the Digital Media Recorder will record the program highlighted in the channel listing.

When the *Listings* menu is highlighted on the menu bar, the following Action buttons appear depending upon where you are in the program listings:

- **+ 24 hrs** Press 3 on the remote control to go 24 hours ahead in the Listings guide.
- **- 24 hrs** Press 1 on the remote control to go back 24 hours in the Listings guide.

Note: The GUIDE Plus+ System doesn't list previous shows – only programs from current time and up to 3 days in advance appear in the Listings.

Sort

The *Sort* menu lets you browse programs by different categories, such as Sports, Movies, or Children's programs – alphabetical order (A-B-C) is the default listing when you access the *Sort* menu. Use the arrow buttons to highlight a letter and press the OK button (the programs beginning with that letter appear).

You can also sort by other categories such as Sports, Movies, and Children's programs. Use the arrow buttons to highlight the option you want and press OK.

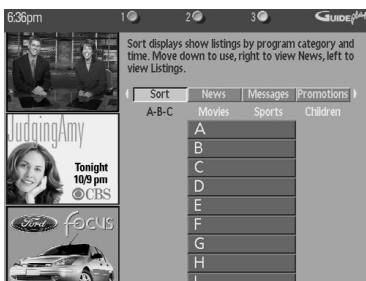

Chapter 3: Using the Recorder's Features

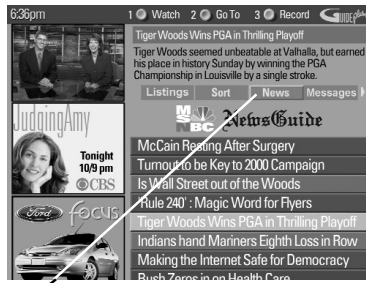

Menu bar

News

The *News* menu lets you browse current news stories by headline.

After you've highlighted the *News* menu from the Menu Bar, use the up and down arrow buttons to browse the list one story at a time. To scroll through the stories a page at a time, press the channel up and/or down buttons.

Press the right arrow or the INFO button to see all of the text for the story.

Messages

Occasionally you will receive messages regarding your GUIDE Plus+ system, as well as special programming information. You can access these messages from the *Messages* menu on the Menu bar.

Promotions and Advertising

To find out more information about a program, advertisement or special, use the left arrow button on the remote to highlight the channel listing or promotional information box. You can view a list of all advertisements and promotions, by selecting the *Promotions* menu from the Menu bar.

Action buttons

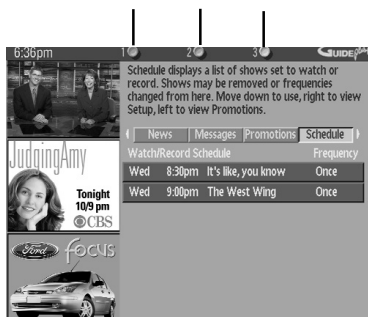

Schedule

The *Schedule* menu allows you to alter the timers you have scheduled via the *Schedule* menu. To change a Watch or Record Timer, highlight the program and use the Action buttons:

- *Remove* Press the 1 button on the remote to remove the program from the Schedule menu.
- *Change* Press 3 on your remote control to change the frequency. Each time you press the 3 button, a different choice is highlighted:
 - DAILY* records the same program each day Monday through Friday.
 - ONCE* records only on that day.
 - WEEKLY* records the program each week at the same time.

Setup

You can do the following in the *Setup* menu:

- *Change system settings* Confirms the settings you completed in the GUIDE Plus+ system setup.
- *Change channel display* You can choose whether to turn channels on (displayed in the Listings Guide), or off (not displayed in the Listings Guide).

Chapter 4

Playing Discs

- **Regional Coding**
- **Using Different Menus**
- **Loading and Playing a Disc**
- **Search Options**
- **Playback Options**
- **Using the On-screen Info Display**
- **Playing MP3 discs**
- **Viewing JPEG files**

Graphics contained within this User's Guide are for representation only. Some of the menu screens, buttons, and display messages might be different in your product than they appear in this book. The on-screen help text provides the most current operational information.

Chapter 4: Playing Discs



- DVD Video discs – contain picture and sound (DVD-R, DVD-RW, DVD+R, DVD+RW, and DVD ROM are compatible with this player)
- CDs (CD-R, CD-RW, CD ROM) – Audio CDs contain musical or sound content only. MP3 discs are CDs that contain MP3 files. This player is also capable of playing CDs that contain JPEG files, and Multisession CDs.
- Video CD discs – Like DVD video discs, VCDs contain picture and sound content. The difference is the amount of information that can be stored on the disc. VCDs typically have lower picture and sound quality than DVD discs.

Super Video CDs (S-VCDs) can be used to record up to 70 minutes of digital sound and video, with MPEG-2 standard video and MPEG-1 standard audio. S-VCD disc compatibility is dependent on which MPEG coding software, disc design software, disc writer software are used, and the discs themselves.

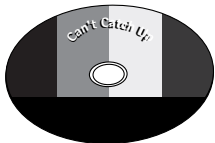

This is an example of a one-sided disc.



This is an example of a two-sided disc – the title is usually in the center of the disc.

Note: Some discs may not be compatible due to laser pickup and disc design.

Regional Coding

Both the Digital Media Recorder and the discs are coded by region. These regional codes must match in order for the disc to play. This player's code is region 1.

Using Different Menus

Each disc is programmed with different features. There are three separate types of menus that you can use to access features:

- **The Disc menu** – The Disc menu is part of each disc and is separate from the Digital Media Recorder's menu. The contents of each Disc menu vary according to how the disc was authored and what features are included.
To make the Disc menu appear, press the MENU button while the disc is playing.
- **The Digital Media Recorder's Info Display** – The Info Display appears as icons across the top of the screen when a disc is playing. It can only be accessed while you are playing a disc. It's turned on and off with the INFO button on the remote. The Info Display icons change based on the type of disc you're playing. Go to page 34 for more information.
- **The Digital Media Recorder menu** – If you're playing a disc, press STOP (the Digital Media Recorder's menu appears automatically).

Remember: A feature will only work if the disc was programmed with that feature. For example, if you choose subtitles on the Info Display, the subtitles will only appear if the disc was created with subtitles. If a menu or icon is "grayed out" it means that item (or feature) isn't available.

To Load and Play Discs

Turn on the TV and your Digital Media Recorder (press ON•OFF on the remote or press the STANDBY/ON button on the Digital Media Recorder).

1. Make sure the TV is tuned to its Video Input channel (if you need more information, go to page 16).
2. Press the OPEN/CLOSE button (the disc tray opens).
3. Place a disc gently into the tray with the disc's label facing up (double-sided discs have content on both sides, so you can place either side up).
4. Press the OPEN/CLOSE or PLAY button. The disc tray closes. The Digital Media Recorder reads the disc's table of contents, and then one of three things happens depending on how the disc was programmed:
 - The disc starts playing.
 - The disc menu appears on the screen. One of the options will start disc play. Highlight that option and press OK.
 - The Digital Media Recorder's main menu appears on the screen. Highlight the Disc menu and press PLAY.

Note: If you don't see a picture, press STOP (the main menu appears), and check the position of the PROG SCAN switch on the back of the unit. Make sure the PROG SCAN switch is in the OFF position. Try playing the disc again.

The only time the PROG SCAN switch should be in the ON position is if you connected this unit to a progressive scan TV via COMPONENT jacks.

When you stop playing a disc, the player remembers where you stopped. When you start playing the disc again, the Digital Media Recorder picks up where you left off unless the disc is removed or the player is unplugged, or you press the STOP button twice.

Search Options

Picture Scan

To search a disc, use the FORWARD or REVERSE button. Each time you press FORWARD or REVERSE, your Digital Media Recorder scans the disc faster until you reach the fastest scan speed. To resume normal playback, press PLAY.

Freeze Frame and Frame Advance

While a disc is playing, press PAUSE to freeze the picture. To advance one frame at a time, press PAUSE again (the on-screen icon changes from *PAUSE* to *FRAME*). Each time you press the FORWARD or REVERSE button, the picture goes to the next (or previous) frame. To resume normal playback, press PLAY.

Slow Motion (in Freeze Frame Mode)

While a disc is playing, press PAUSE. Press REVERSE or FORWARD (each time you press REVERSE or FORWARD the slow motion will get even slower until you reach slowest speed). To resume normal playback, press PLAY.

Time Search

Make sure the Time Display in the Info Display is highlighted, and then use the number buttons to enter a specific time on the disc that is playing. Go to page 35 for more information about the Time Display.

Quick Fast Forward and Quick Reverse

While you're playing a disc, press the AGAIN button on the remote (the disc automatically repeats the last 10 seconds of the movie).

Similarly, press the ADVANCE button to go forward approximately 30 seconds.

Playback options

Many of your Digital Media Recorder's playback features are accessed through the Info Display (described on pages 32 through 37). Additionally, with some discs you can use the Zoom Feature to see details of an image.

Zoom

1. While you're playing a disc, press ZOOM (the player zooms in on the image). Each time you press ZOOM, the picture is magnified even more (until you get to the maximum zoom level).
2. To see other parts of the picture when you've zoomed in on the image, press the up, down, left, and/or right arrow buttons to go in corresponding directions.

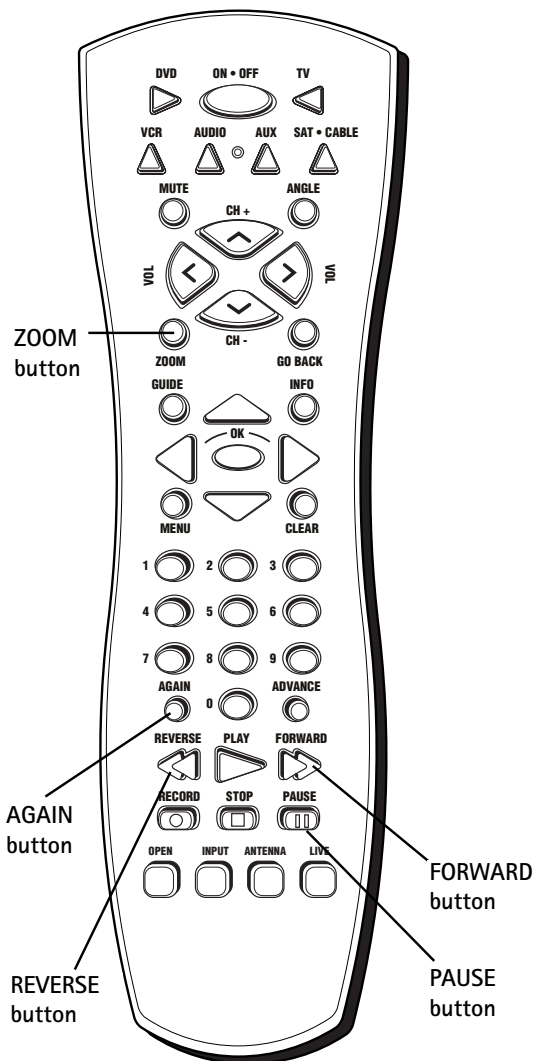

Chapter 4: Playing Discs

Using the On-Screen Info Display

The on-screen Info Display contains many playback features. To see the Info Display, press the INFO button on the remote while a disc is playing (the Info Display appears across the top of the screen). Each feature is illustrated with an icon. Use the left and right arrow buttons to move through the different icons in the Info Display. When an icon is highlighted, use the up and down arrow buttons on the remote to scroll through the choices.

Remember, you can only access the Info Display when you're playing a disc. Also, the Info Display features are only available if the disc was created with that particular feature (i.e., if you select the Angle icon, you won't be able to change the camera angle unless the disc was created with different camera angles). If one of the icons is "grayed out," the Info Display feature isn't available for the disc you're playing.

 The invalid symbol appears on the screen when you press a button that doesn't have any function. To make the Info Display disappear from the screen, press INFO on the remote control.

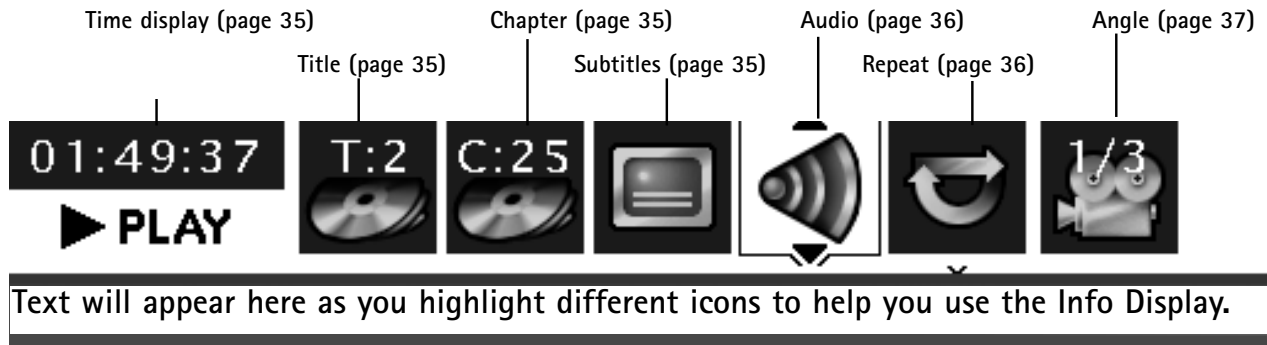

This is the Info Display you'll see when you're playing a DVD disc.

To make the Info Display appear, press the INFO button on the remote control. Use the left and right arrow buttons to highlight different icons. Use the up and down arrow buttons to scroll through the choices available.

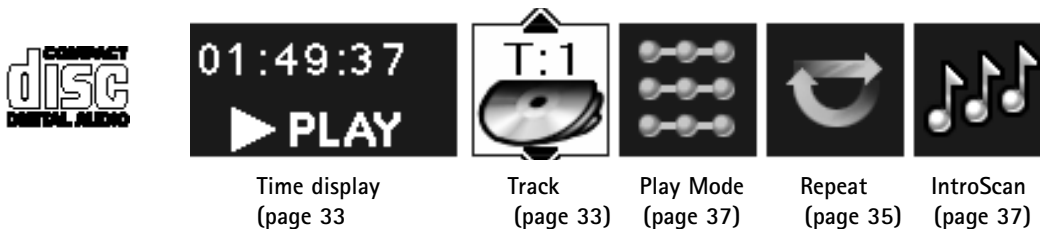

This is the Info Display you'll see when you're playing an audio CD.

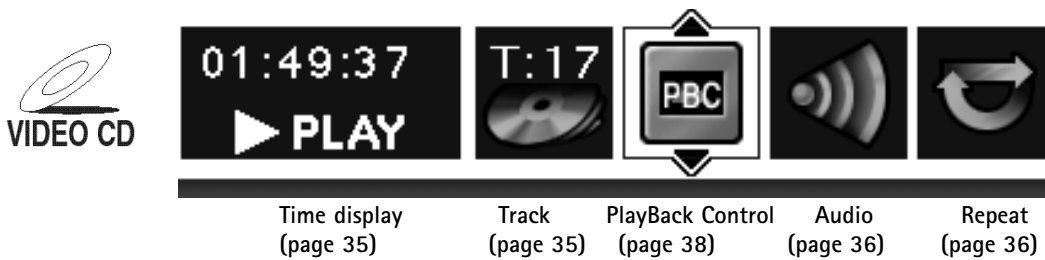

This is the Info Display you'll see when you're playing a Video CD, also called a VCD.

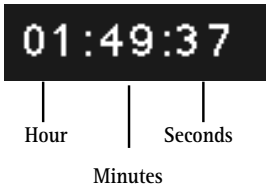

Time Display (DVD, Video CD, and Audio CD)

This feature displays the time that has elapsed during playback. For DVD discs, the time displayed refers to the current title and acts as a Time Search feature. For example, if you like a particular scene in a movie, you can enter the elapsed time the scene plays and skip right to it.

1. Highlight the Time Display and use the number buttons on the remote to enter the elapsed time you want to go to in that title. You must use two digits for each field. For example, if you enter 01:35:12, playback will start one hour, 35 minutes, and 12 seconds into the title.

Note: For Audio CDs, the time displayed refers to the track that's playing.

Selecting a Title on DVDs or a Track on Audio CDs or Video CDs

Some discs contain more than one title. For example, there might be four movies on one disc (each movie might be considered a title). Each title is divided into chapters.

To select a title via the Info Display, highlight the Title icon with the right arrow button on the remote control. Press the up or down arrow button to go to the next title: When you're playing a VCD or an Audio CD, use these instructions to go to a different Track.

Note: Many discs only have one title.



Chapter Icon (DVD)

Because DVD discs use digital technology, a title can be divided into individual chapters (similar to tracks on a CD). You can skip to a specific chapter by using the Chapter feature in the Info Display.

1. While a disc is playing, press INFO on the remote (the Info Display appears).
2. Press the right arrow button until the chapter icon is highlighted.
3. Press the up and/or down arrow buttons to go to different chapters.

Notes:

You can also use the number button(s) on the remote to enter the chapter you want to play—enter 2 digits (for example, to go to chapter 4, press 0 and then press 4). The movie starts playing at the beginning of the chapter you entered.

The Chapter feature won't work if the disc isn't formatted with separate chapters.

Shortcut
While you're playing a disc, you can use the CH +/ CH- buttons to go to the next chapter or previous chapter.



Subtitle Icon (DVD)

To change the subtitle language, highlight the subtitle icon and press the up or down arrow buttons to scroll through the choices (the subtitle language options appear in the box at the bottom of the Info Display).

Notes:

Changing the subtitle language with the Info Display will only affect the disc you are currently playing. When the disc is removed or the player is turned off, the subtitle language will revert to the language setting specified through the Digital Media Recorder's Language menu.

If the disc doesn't contain the language you want to use, the disc's default language is automatically selected.

Some discs are programmed to only allow you to access the subtitle feature through the disc's menu. If changing subtitle language via the Info Display doesn't work (as described above), press MENU and change the subtitle language via the disc's menu.

Chapter 4: Playing Discs (DVDs)



Repeat Icon (DVD, Video CD, and Audio CD)

By default, the Repeat feature is Off. There are three Repeat options:

- Title – repeats the title that is playing
- Disc – repeats the chapter that is playing
- A-B – repeats a segment of the disc that you select.

Repeating Titles, Chapters, or Tracks

1. While a disc is playing, press INFO (the Info Display appears).
2. Press the right arrow button until the Repeat icon is highlighted.
3. Press the up or down arrow button to scroll through the different Repeat options – *Repeat title*, *Repeat disc*, *Repeat AB*, and *Repeat Standard* (the modes appear at the bottom of the Info Display).
4. To turn off the Repeat feature, press the up or down arrow button repeatedly until *Repeat Mode: Standard* appears.

AB Repeat

AB Repeat lets you define a specific segment on the disc that you want to repeat. For example, you might want to watch a specific scene from a movie repeatedly:

1. Follow steps 1 and 2 above.
2. Press the up (or down) arrow button until *Repeat Mode: AB. Press OK to set A point* appears at the bottom of the Info Display. Press OK when the disc gets to the beginning point of the segment (the A point) that you want to repeat.
3. Allow the disc to play to the end of the segment you want to repeat. Don't fast forward – you must let the disc play in standard playback mode to set the B point (the ending point of the segment). Press OK to set the B point (the segment you marked will play repeatedly until you turn off the Repeat feature).
4. To turn off the Repeat feature, highlight the Repeat icon, and press the up arrow button on the remote until *Repeat Mode: Standard* appears at the bottom of the Info Display.

Note: Repeat is also cancelled when you eject the disc from the Digital Media Recorder.



Audio Icon (DVD and Video CD)

If the disc was created with different language tracks (recorded in different languages) or different audio formats (Dolby, DTS, stereo, etc.), you can change the audio option while you're playing the disc.

1. While a disc is playing, press INFO (the info display appears).
2. Press the right arrow button until the Audio icon is highlighted.
3. Press the down arrow button on the remote to scroll through the available audio options.
4. When the option you want to use is highlighted, press the OK button.

Notes:

The language feature only works if the disc was created with multiple language tracks. If the disc doesn't contain the language you selected, the disc will play in the default language.

When you choose an audio language during disc playback, you only override the audio language setting in the Digital Media Recorder's Language menu temporarily.

Some discs are programmed to only allow the audio setting to be changed via the disc's menu. If changing audio option via the Info Display doesn't work (as described above), press MENU and change the audio setting via the disc's menu.



Camera Angle Icon (DVD)

Some discs contain multiple angles of a particular scene or sequence. If the disc only has one angle, this feature won't work. Currently, very few discs have this feature.

1. While a disc is playing, press ANGLE on the remote. If the disc wasn't created with multiple angles, the invalid symbol appears. If the disc contains multiple angles, the Angle icon appears with the current angle number and the number of angles available. For example, 1/4 indicates that Angle 1 is displayed and there are 4 different angles available.
2. Press the up arrow button to go to the second camera angle. Press the arrow button again to go to the third angle, etc.
3. To resume normal playback, scroll through the camera angles until you get to Angle Off.

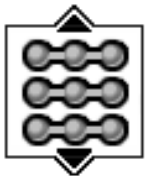

Play Mode Icon (Audio CD)

When you play audio CDs, the various Play Modes are available from the Info Display. The Play Mode feature lets you set up the order in which you want the tracks on the CD to play. There are three Play Modes:

Standard: the tracks play in the same order as listed on the CD (starting with track 1). This is the default play mode.

Random: the tracks on the CD play in a random order.

Program: the tracks play in the order you designate. To use the Program play mode, you must set up the order in which you want the tracks to play in the Digital Media Recorder's main menu system (go to page 43 for instructions).

Random

The Random option plays the tracks in a random order.

1. While you're playing a disc, press INFO (the Info Display appears).
2. Press the left or right arrow button to highlight the Play Mode icon.
3. Press the down arrow button until *Play Mode: Random* appears in the text at the bottom of the Info Display (the tracks start playing in random order).

To switch back to Standard Playback, follow steps 1 through 3 above until *Play Mode: Standard* appears underneath the Info Display icons.

Note: The player defaults to Standard Playback whenever you put a new CD into the Digital Media Recorder.

Program

The Program Play Mode is only available after you set up a playlist via the Digital Media Recorder's *Disc* menu (page 43).

Chapter 4: Playing Discs (Audio CDs)



IntroScan Icon (Audio CD)

Use the IntroScan feature to preview each track on the CD.

1. While the CD is playing, press INFO (the Info Display appears).
2. Use the arrow buttons to highlight the IntroScan icon.
3. Press OK (the first 20 seconds of each track starts playing).



Playback Control (PBC) Icon (Video CD)

Use the arrow buttons to highlight the Playback Control icon. Press the up or down arrow button to go back and forth between On and Off. Playback Control enables you to access the VCD's menu if it has one.



Playing mp3 Discs

MP3 (MPEG-3, which stands for Motion Picture Experts Group-Layer 3, meaning the third layer of information) is a format used to compress digital audio. Since the audio is compressed, it takes up less space.

Note: You can only play true MP3 files in the Digital Media Recorder – some products use software to compress MP3 files and convert them to other formats such as MPX. Your Digital Media Recorder won't recognize or play MPX files or other types of converted MP3 files.

Creating an MP3 Disc on Your Computer

Your Digital Media Recorder handles MPEG-1, layer III audio. If you encode your own MP3 files from an audio CD, avoid using the features of MPEG-2, such as the 22kHz sampling frequency.

Be sure to make a data CD rather than an audio CD. If you make an audio CD, you will lose the extra features and compression of the MP3 format.

When you burn a CD, select ISO-9660 for the file system in your CD burning software.

Notes:

Help – For more information regarding MP3 encoding software and MP3 sites, visit www.lyrazone.com.

The Joliet file system is not recommended. Using the Joliet file system may result in shortened file names.

Some transport modes (reverse and fast forward) are not available for MP3 CDs.

For more help and recommendations about MP3 files, go to page 52.

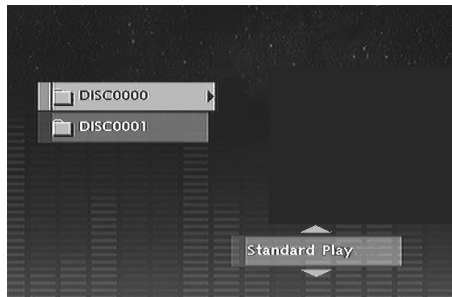

The mp3 Display

MP3 discs contain individual songs that can be organized into folders – similar to how you use your computer to put documents (files) into different folders when you burn them onto the CD. The contents of a folder can either be songs or more folders (subdirectories).

Selecting Folders and Songs

Use the arrow buttons on the remote control to highlight various files and folders. Press OK to select a file and/or folder.

1. Insert the disc.
2. From the main menu, highlight *Disc* and press OK (the mp3 files and/or folders that are on the disc appear).
3. Use the arrow buttons to highlight songs and/or folders.
4. To play a song (or the songs in a folder) that is highlighted, press PLAY.
5. To return to the main menu, press STOP twice or the left arrow button.

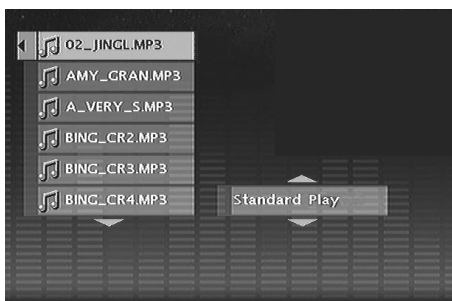

Saving mp3 files to the hard disk drive

1. Press MENU (the main menu appears).
2. Highlight *Disc*, and press OK.
3. Highlight *Copy*, and press OK.
4. When you copy mp3 files to the Digital Media Recorder's hard disk drive, they are saved in the *Music* menu. For information about the *Music* menu, go to page 44. For information about renaming and deleting mp3 files, go to pages 26, 27, and/or 28.

Note: There isn't an Info Display when playing MP3 files.

Note: If you choose to copy the mp3 files to the hard drive, be aware that all MP3 files will be saved to the hard disk drive – you can't select particular files and/or folders. Also, you won't be able to use your Digital Media Recorder while MP3 (or JPEG) files are being saved to the hard disk drive.

Chapter 4: Playing Discs (JPEG files)

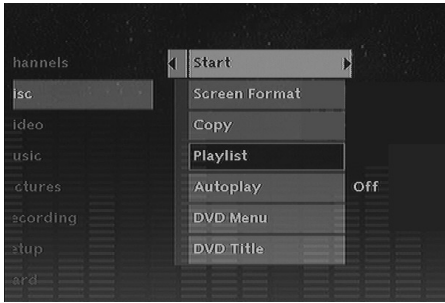

Viewing JPEG files

The Digital Media Recorder can play discs with JPEG files on them.

1. After you put the disc in the Digital Media Recorder, choose *Disc* from the main menu.
2. Since *Start* is highlighted, press the OK button on the remote.
3. If *Music/Pictures* selection screen appears, select *Pictures* and press OK (the folders and/or JPEG files appear on the screen). Use the up and/or down arrow buttons to highlight a folder. To start playback, you have several options:
 - Press PLAY (all of the files in the folder selected will play).
 - Press the right arrow button to highlight the box entitled *Normal* (right side of screen)To play the JPEG files press OK (the JPEG files will play one after another in a slideshow format at normal speed).
To speed up the slide show or slow it down, press the up and/or down arrow buttons until *Slow* or *Fast* is visible and press OK.
4. If the picture appears upside down or sideways during playback, press the PAUSE button. To rotate clockwise, press the right arrow button. To rotate the picture counter-clockwise, press the left arrow button.
5. To magnify the image, press ZOOM (the player zooms in on the image). Each time you press ZOOM, the picture is magnified even more (until you get to the maximum zoom level and it returns to regular view).
6. To see other parts of the picture when you've zoomed in on the image, press the up, down, left, and/or right arrow buttons to go in corresponding directions.

Notes:

You can't play other types of pictures in the Digital Media Recorder — only JPEG files.

If the Digital Media Recorder isn't reading the disc, one or more of the files might be too large. Recommended size is less than 2MB (megabytes).

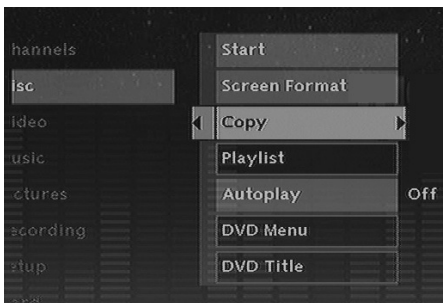

Saving JPEG files to the hard disk drive

1. Press MENU (the main menu appears).
2. Highlight *Disc*, and press OK.
3. Highlight *Copy*, and press OK.

Note: All JPEG files will be saved to the hard disk drive — you can't select particular files and/or folders. You won't be able to use your Digital Media Recorder while JPEG files are being saved to the hard disk drive.

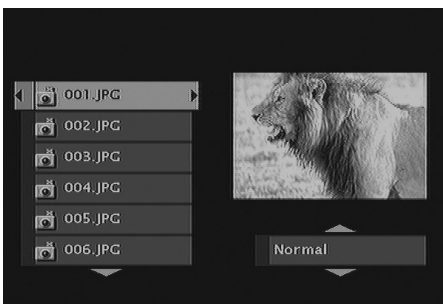

4. When you copy JPEG files to the Digital Media Recorder's hard disk drive, they are saved in the *Pictures* menu.

For information about the *Pictures* menu, go to page 44. For information about renaming and deleting JPEG files, go to pages 26, 27, and/or 28.

Chapter 5

The Menu System

- Overview of the Digital Media Recorder's Menu System
- Channels Menu
- Disc Menu
- Video Menu
- Music Menu
- Pictures Menu
- Recordings Menu
- Setup Menu
- Using the Parental Control Feature

Graphics contained within this User's Guide are for representation only. Some of the menu screens, buttons, and display messages might be different in your product than they appear in this book. The on-screen help text provides the most current operational information.

Chapter 5: The Menu System

Overview of the Digital Media Recorder's Menu System

Since this product has many features, it has a wealth of menus and options. To access the main menu during playback, press the STOP button on the remote. To access the main menu when you're not playing a disc or a program that you recorded to the hard disk drive, press the MENU button.

How to navigate through on-screen menus

Throughout the Digital Media Recorder's menu system, you'll see arrows on the on-screen menu bars to indicate that more choices are available. Use the corresponding arrow buttons on the remote control to scroll through the choices. To select a choice or a menu, press the OK button.

To return to the previous menu, press the left arrow button or GO BACK.

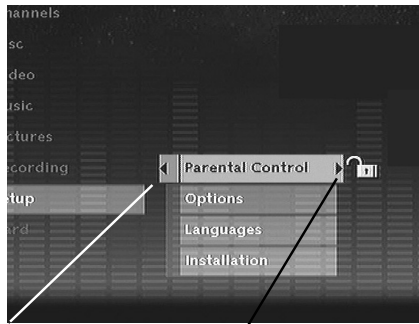

Press the left arrow button on the remote to go to the previous menu.

Press the right arrow button or the OK button on the remote to see the Parental Control menus.

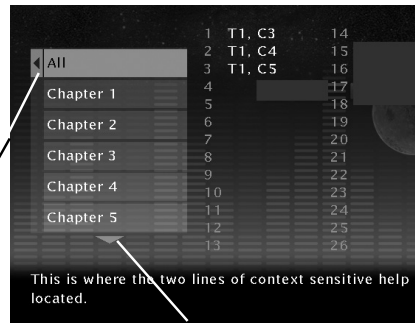

Press the left arrow button on the remote to go to the previous menus.

Press the down arrow button on remote control to see more options.

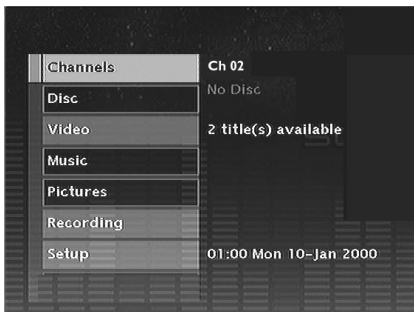

The Main Menu

The main menu is divided into the following submenus:

Channels - shows current channel number or input.

Disc - plays a disc, enables you to create a customized playlist for DVD discs and audio CDs, enables you to transfer contents from a disc to the Digital Media Recorder's hard drive, selects the screen format for DVDs, and accesses title menus and disc menus for DVDs. Go to page 43 for details.

Video - shows you the programs that are stored on the Digital Media Recorder's hard disk drive (the content you've recorded). Video refers to content that has both audio and video, like a TV show. Go to page 44 for details.

Music - lists the files and folders of MP3 music you've copied to the Digital Media Recorder's hard drive. Go to page 44 for details.

Pictures - lists files and folders of JPEG pictures. Go to page 43 for details.

Recording - accesses recording options such as timer recording and recording quality. Go to page 44 for details.

Setup - accesses all of the menus from the Interactive Setup (the menu you went through the first time you turned on the product); parental controls (rating limits); language options for on-screen menus and discs; and advanced settings for audio and component video. Go to page 45 for more information.



Channels

Shows the current channel or input. To watch TV, press OK when the *Channels* menu is highlighted (the channel banner appears to show you channel, audio selection, and the current mode, such as Live, Delayed, Pause, etc.).

Disc Menu

You can only access the disc menu when you've inserted a compatible disc into the Digital Media Recorder. The submenus follow:

Start: starts playing the disc.

Screen format: the setting you choose adjusts the way a movie appears on your TV (DVD discs only). Standard TVs are 4 x 3 format. Depending on the type of television you have, you may want to adjust the screen setting (also called the aspect ratio). The choices follow:

4 x 3 Standard – Choose this setting if you want the movie to fill the entire screen of your TV. This might mean that parts of the picture (the left and right edges) won't be seen. Most discs that are produced in a widescreen format only can't be cropped in this fashion. This means the black bars might appear at the left and right sides of the screen.



4 x 3 Letterbox – Choose this setting if you want to see movies in their original aspect ratio (height-to-width ratio). You'll see the entire frame of the movie, but it will take up a smaller portion of the screen vertically. The movie might appear with black bars at the top and bottom of the screen.

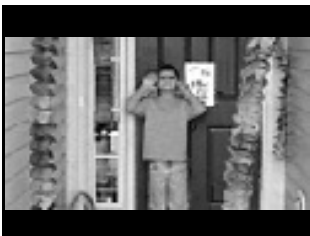

16 x 9 – Choose this setting if your Digital Media Recorder is connected to a widescreen TV. If you choose this setting and you don't have a widescreen TV, the images on the screen might appear distorted due to vertical compression. If you play a disc recorded in 4 x 3 format on a widescreen TV, the left and right sides of the screen will appear black.



Save: available when you've inserted a CD (with MP3 or JPEG files on it), and enables you to transfer the content from the disc to the Digital Media Recorder's hard disk drive.

Playlist (available for Audio CDs only): You can create a customized playlist just like you can with many CD players where you rearrange the order in which the songs play. The playlist is played via the *Program Play* option in the Info Display (page 37). To set up a playlist, follow the on-screen instructions.

Autoplay: When you select *On*, a disc immediately starts playing after you insert it into the player (there's no need to press the PLAY button).

DVD Menu: available when you've inserted a DVD disc that has its own menu. Press OK to access the disc's menu.

DVD Title: less common than DVD disc menus, some discs have Title Menus – the DVD might have more than one title and each title might have a separate menu for each movie or program.

Chapter 5: The Menu System

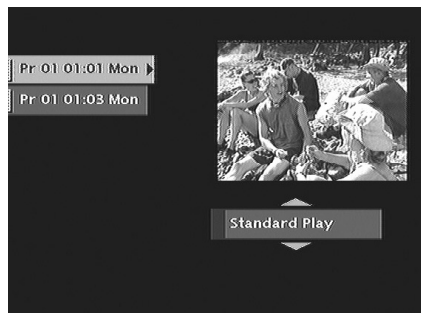

Note:

To go back to a previous menu, press the left arrow button or GO BACK.

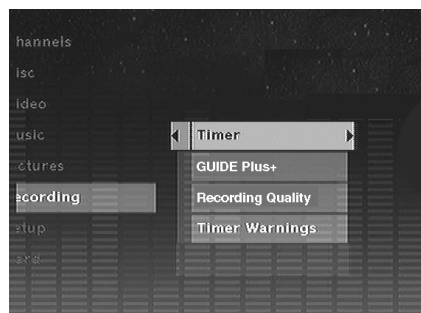
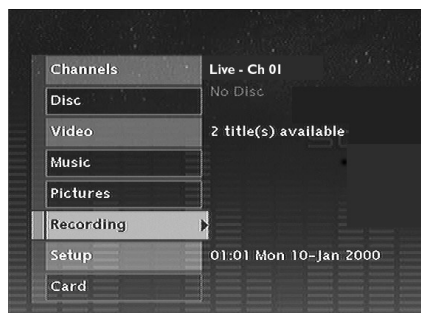
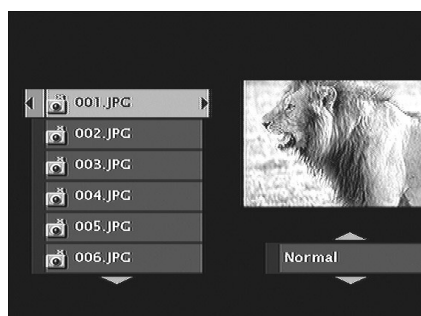

Note:

Times listed in Recording Quality menu are approximate. How much recording time there is on the hard disk drive is also affected by the number and size of JPEG or MP3 recordings that are stored on the hard disk drive.

Video

Video refers to programs you recorded from the TV to the Digital Media Recorder's hard disk drive. From the *Video* menu, you can choose to play a program by using the arrow buttons to highlight it, and pressing the PLAY button. To delete or rename a program, press the right arrow button to highlight the box on the right side of the screen. Use the up and down arrow buttons to scroll through the options and follow the on-screen instructions. When you're recording a program, it appears in this menu as *In progress*. For more playback information, go to page 27.

Music

Music refers to mp3 songs.

From the *Music* menu, you can choose to play a song (or a folder of songs) stored on the hard disk drive or delete it (them), or rename a file or folder. Once you've highlighted a file or folder from the *Music* menu, use the right arrow button to go to the box on the right side of the screen. Use the up and down arrow buttons to scroll through the options. Press OK to select the option that appears in the box. For more information about playing mp3 songs, go to page 39.

Pictures

From the Pictures menu, you can choose to view pictures (JPEG files) stored on the hard drive, rename them, or delete them. For more information about JPEG files, go to page 40.

Recordings

The *Recordings* menu contains special settings for recording to the hard disk drive.

Timer: Sets up automatic recordings. Timer recordings are especially useful when you have a favorite program that you want to record every week and/or every day. If you use a cable box, the cable box must be On during the timer recording; if you're recording from satellite, the satellite set-top box, also called a receiver, must be On).

GUIDE Plus+: Your on-screen GUIDE Plus+ program guide also has an automatic recording feature. You can only set up recordings that the guide lists such as programs from cable, cable box, or off-air reception. The Guide Recording menu can't set up recordings from a satellite program provider.

Recording Quality: Similar to quality settings on a VCR, you tell the Digital Media Recorder what quality you want to use for the recording – the better the quality, the more memory (space) the recording will use on the Digital Media Recorder's hard drive and the less recording time you'll have. The recording quality choices are listed as the amount of time you can record onto the hard disk drive – the more time you can record, the lower the video quality. The choices are:

10h (hours)	high quality
20h (hours)	normal quality
30h (hours)	basic quality
40h (hours)	low quality

Timer Warnings: This menu lets you set how far in advance you would like the Digital Media Recorder to send a warning if the hard disk drive is full.

Changing the *Timer Warning* setting is helpful if you're planning to be out of town, and you've set up 5 different timer recordings via the *Timer* menu. Since you're going to be out of town, you might want to change the setting to 36 hours (if you leave it set at 12 hours, you won't be there when the Recorder alerts you).

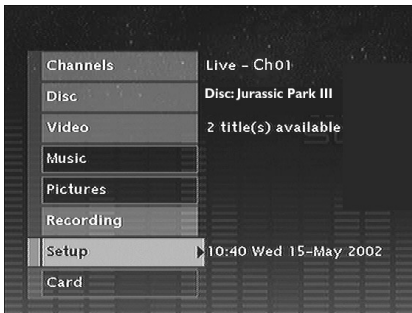

Setup

The Setup menu contains many submenus that are explained on the following pages. The following list is an overview. Follow the instructions at the bottom of the screen.

Note: To return to a previous menu, press the left arrow button.

Parental Controls: set ratings limits and a password for DVD discs. For details, go to page 47.

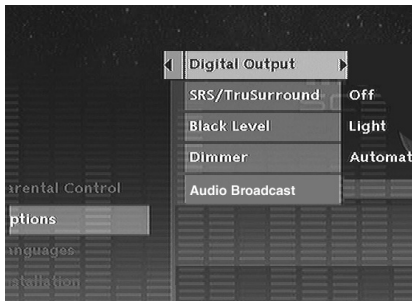

Options: Contains settings and menus for audio features, as well as black level settings and dimmer options for the front display of your Digital Media Recorder.

Digital Output: If you connected your Digital Media Recorder to a receiver via the DIGITAL AUDIO OUT jack (COAXIAL or OPTICAL) on the back of the player, choose the type of receiver (or decoder) you have: Dolby Digital and/or DTS.

Note: If you select DTS, and you don't have a DTS receiver connected to the Digital Media Recorder you won't hear any audio or the audio will be distorted.

SRS/TruSurround: The TruSurround® feature simulates a six-speaker listening experience through just two speakers. The default setting is *Off*. To turn on the Virtual Surround® feature highlight *SRS/TruSurround*, and press OK. Highlight *On* and press the OK button.

Black Level: Adjusts how bright the picture appears. Choose between *Dark* and *Light*. Use the arrow buttons to highlight a choice and the OK button to select the choice that's highlighted.

Dimmer: Adjusts the brightness of the display on the front of the Digital Media Recorder. Use the arrow buttons to highlight a setting, and the OK button to select the option that's highlighted. The choices follow: *Automatic* (the display automatically dims during playback); *Bright*; *Dim*.

Audio Broadcast: Selects audio format from the broadcast signal – *Mono*, *Stereo*, *SAP* (Second Audio Program). If you select *SAP* and the program you record is available with *SAP* audio, both *SAP* and mono audio will be recorded. During playback, you can decide which audio you want to play – *SAP* on the right channel or *Mono* on the left channel.

Languages: Selects different languages for on-screen menus, subtitles and audio language of certain discs.

Display: the language that appears when you access this menu the first time reflects the option you chose during the interactive setup. To change the language of the on-screen displays (menus), use the arrow buttons to highlight a language and press OK to select it.

Audio: the language that appears when you access this menu the first time reflects the option you chose during the interactive setup. You can change the audio language by highlighting an option and pressing the OK button.

Subtitles: Some movies on DVD discs have subtitles. Set up your default settings in this menu. You can quickly override these settings while playing a disc by using the Info Display (go to page 35 for information).

Automatic: matches the language you selected during interactive setup.

Off: subtitles won't appear on the screen.

On: if the title (movie) has subtitles available, they will appear automatically.

Original: subtitle language will match the original audio (dialogue) language of the title (movie).

Disc: Many discs have their own menu that appears on the screen. You can select the language in which you want the disc menu displayed. In order for your setting to take effect, the disc's menu must have been created with the corresponding language option.

Note: Currently, very few Region 1 discs have multiple language disc menus.

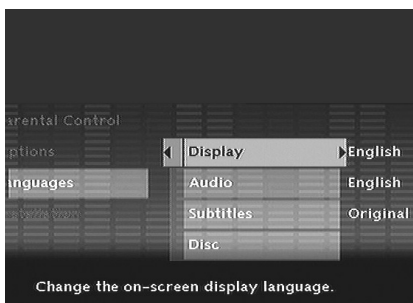

TruSurround  is a trademark of SRS Labs, Inc. TruSurround technology is incorporated under license agreement from SRS Labs, Inc.

Chapter 5: The Menu System

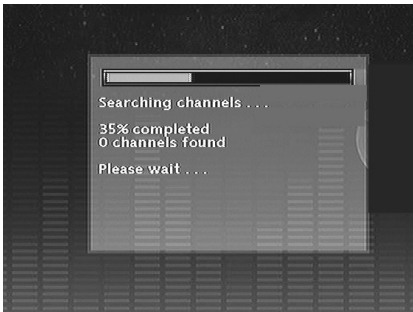
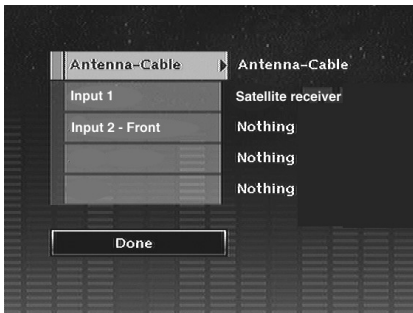

Installation: The submenus contained in the *Installation* menu pertain to the way you've connected the Digital Media Recorder to other components such as your TV, satellite receiver, and or cable box. If you move, or change any of the information you gave the Digital Media Recorder when you set it up initially, you need to change the information in these menus.

Interactive Setup: The first time you turned on your Digital Media Recorder, you had to complete an interactive setup so your Digital Media Recorder could have the information it needs to function properly. For details about the Interactive Setup, go to page 12. To go through this procedure again to change settings, highlight *Interactive Setup* and press the OK button.

Channel Search: If you've changed program providers (cable and/or satellite), the Channel Search will automatically search the signal and put the latest channels in the Digital Media Recorder's channel list. Use the arrow buttons to highlight *Channel Search*, and press OK to begin (a progress indicator appears to let you know how quickly the search is being completed).

Manual Clock: If the clock is incorrectly set or you skipped this step during the initial setup, you can set the Digital Media Recorder's clock using the number buttons on the remote and the arrow buttons to navigate. Follow the on-screen instructions.

Note: In order for Timer Recordings to work, you must set the clock to the correct time and date.

Channel List: Enables you to change what channels are accessed when you press the Digital Media Recorder's channel up and down buttons (if you delete a channel from the channel list, you can still access it by using the number buttons on the remote). For more explanation, go to page 14.

GUIDE Plus+: Enables you to change settings that pertain to the on-screen programming guide that's built into your Digital Media Recorder.

Setup: The first time you turned on your Digital Media Recorder, you had to complete an interactive setup so your Digital Media Recorder could have the information it needs to function properly – part of this initial setup included information for the GUIDE Plus+ programming guide. If any of your information has changed (you moved, or you've changed cable your cable service), access this menu to complete the GUIDE Plus+ Setup again.

Label: If you choose On, the station name appears when you change channels. If your set Label to Off, the station name doesn't appear when you change channels.

Using Parental Controls

You can set up ratings limits and turn on the Parental Control feature in order to control the type of discs people can play in the Digital Media Recorder. The padlock icon on the Lock menu indicates whether the player is locked or unlocked.

 **Locked:** You need to enter the password in order to play discs that have a higher rating than what you've allowed. When the player is locked, nobody can access the Lock menu without entering the password.

 **Unlocked:** No password required to play discs. Even if you've set ratings limits, they won't be enforced when the player is unlocked.

Notes:

The player is shipped unlocked without any rating limits set. If you want to use the Parental Control feature, set Ratings Limits and then lock the player.

Don't confuse the Digital Media Recorder's Parental Control feature with a parental control feature that may be in your TV, often referred to as V-Chip. The ratings described here refer to discs that you play in the recorder, not TV programs.

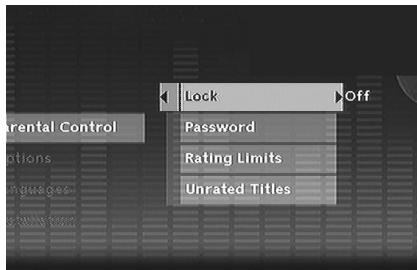
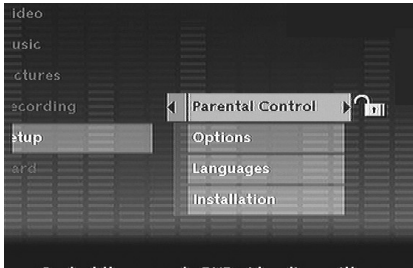

Lock (and Unlock)

1. From the Digital Media Recorder's main menu, select *Setup* and press OK (the *Setup* menu items appear).
2. Since *Parental Control* is highlighted, just press the OK button (the *Parental Control* menu items appear).
3. Since *Lock* is highlighted, just press the OK button on the remote.
4. If prompted to enter a password, use the number buttons on the remote control and press OK (*Confirm Password* appears). Enter the same numbers you entered before and press OK.
5. To return to the previous menu, press the left arrow button.

Once the player is locked, you'll need to enter the password everytime you access the menu.

Note: The player is shipped without any rating limits set. You need to set Ratings Limits (go to page 48 for instructions) in order for the player to prevent people from playing discs with certain ratings.

Password

You can change your password.

1. From the Digital Media Recorder's main menu, select *Setup* and press OK (the *Setup* menu items appear).
2. Since *Parental Control* is highlighted, just press the OK button (the *Parental Control* menu items appear).
3. Highlight *Password*, and press OK.
4. Use the number buttons on the remote to enter the four-digit number that you want to use as your new password, and press OK (you will be prompted to enter your new password again to confirm). Enter your password, and press OK.

Chapter 5: The Menu System

Rating Limits

The *Rating Limits* menu lets you determine what types of discs can be played in the player, and what types of discs will require a password to override the rating limit that you've set. In the U.S., the ratings feature is based on the ratings set up by the MPAA (Motion Pictures Association of America) such as R, PG, G, etc.

The system ranks the ratings from 1 to 8 in order to accommodate ratings systems used in other countries (1 is considered material that is least offensive and 8 is considered the most offensive).

Note: In order for the Ratings to be enforced, the Digital Media Recorder must be locked and the disc you're playing must contain a movie (or a title) that is rated.

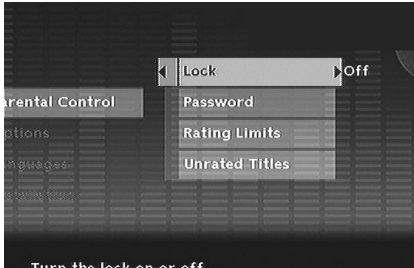

To set Ratings:

1. From the Digital Media Recorder's main menu, select *Setup* and press OK (the *Setup* menu items appear).
2. Since *Parental Control* is already highlighted, just press OK (the *Parental Control* menu items appear).
3. Highlight *Rating Limits* and press OK (the 8-level rating list appears).
4. Use the up and down arrow buttons to move the bar to the rating level you find acceptable.
Ratings that don't require a password (free access) appear under the bar.
Ratings that require a password appear above the bar.
5. Press OK.

Note: You must lock the player (page 47) in order for the ratings to be enforced.

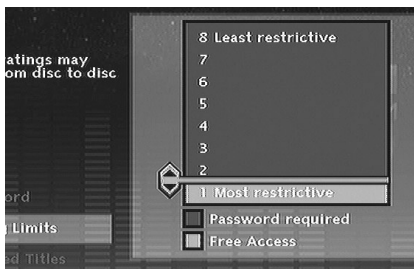

Unrated Titles

Some discs contain titles (or movies) that don't have a rating assigned to them. Sometimes, movies you might find the most explicit are unrated. In order to prevent these movies from being played, you need to choose *Password Required* from the *Unrated Titles* menu, and lock the player.

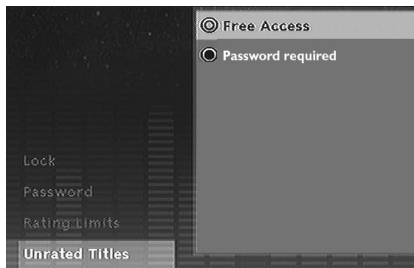

Chapter 6

Additional Information

- **Troubleshooting**
- **Back of the Digital Media Recorder**
- **Front of the Digital Media Recorder**
- **Explanation of Input Jacks and Cables**
- **Limited Warranty**
- **Accessory Information**
- **Saving Digital Media Recorder Content to a VCR**

Graphics contained within this User's Guide are for representation only. Some of the menu screens, buttons, and display messages might be different in your product than they appear in this book. The on-screen help text provides the most current operational information.

Chapter 6: Additional Information

Troubleshooting

GENERAL PROBLEMS

Player won't work (locks up)

- Try unplugging the AC power cord and plugging it back in.
- Reset the Digital Media Recorder: on the front of the unit, press and hold the STANDBY/ON button while you press and hold STOP and OPEN/CLOSE buttons – wait at least 3 seconds before you release all of the buttons. You'll need to set up your menu preferences because this Reset Procedure returns the Digital Media Recorder's menus to the factory default settings.

No power

- Plug in the Digital Media Recorder. Make sure both ends of the AC power cord are securely plugged into the Recorder and into an AC outlet.
- Make sure you've plugged it into a working outlet and/or a power strip that is turned on.
- Don't plug the unit into an outlet that is operated by a wall switch.

Disc tray won't open

- Maybe the Tray Lock feature has been activated. To unlock the disc tray, press and hold the STOP button on the front of the unit and then press and hold the OPEN/CLOSE button on the front of the unit at the same time - wait 3 seconds before releasing both buttons.

No picture

- Turn on the TV.
- Tune your TV to the Video Input Channel that corresponds to the jacks you used to connect the TV to the Digital Media Recorder (go to page 16 for more help).
- If you're playing a DVD, press STOP (the main menu appears). Check the PROG SCAN switch on the back of the unit to make sure it is in the OFF position. Try playing the disc again.
- If you've activated the V-Chip parental control feature in your TV and you are using the Digital Media Recorder's GUIDE Plus+ programming guide, you may have highlighted a channel in the guide that is rated higher than the settings in the TV's V-Chip. Just press the GUIDE button, and then use the Channel buttons to tune to another channel.
- Make sure your Digital Media Recorder is connected properly.

Light is blinking

- There is a problem with a Timer Recording – you've either set up two programs to record at the same time; two programs that overlap; or there's not enough room on the hard disk drive to record. Turn on the TV and Digital Media Recorder, and go to the *Recordings* menu to find out what's wrong.

A screen saver appears on the TV

- Your player is equipped with a screen saver that appears on the TV after your player has been idle for several minutes. To make it disappear, press STOP or CLEAR on the remote.

The menu is displayed in a foreign language

- The *Language* menu (*Display* menu) is set to that language. Go to the *Setup* menu and choose *Languages* (in Spanish, shown as *Idiomas*; in French, as *Langues*), choose the *Display* option. Highlight the language you prefer, and press OK.

Disc won't eject

- When you put a disc into the player, the player may take up to 15 seconds to read the disc. You won't be able to eject the disc during this time. Wait 15 seconds and try again.
- Maybe the Tray Lock feature has been activated. To unlock the disc tray, press and hold the STOP button on the front of the unit and then press and hold the OPEN/CLOSE button on the front of the unit at the same time - wait 3 seconds before releasing both buttons.

I forgot my password

- Press the STOP button on the front of the unit while you press the STOP button on the remote control – keep pressing both buttons for approximately 3 seconds (until the  icon disappears from the front panel display). Release both buttons (the player should be unlocked). If that doesn't work, try resetting the Digital Media Recorder (instructions are listed below).
- Reset the Digital Media Recorder: on the front of the unit, press and hold the STANDBY/ON button while you press and hold STOP and OPEN/CLOSE buttons – wait at least 3 seconds before you release all of the buttons. You'll need to set up your menu preferences because this Reset Procedure returns the Digital Media Recorder's menus to the factory default settings.

PLAYBACK PROBLEMS

Disc won't play

- Insert a disc with the label side facing up.
- Check the type of disc you put into the player. This player only plays DVD video discs, Video CDs, audio CDs, and CDs with true MP3 files and/or JPEG files. MP3 files that have been converted to MPX files (or similar types of files) won't be recognized by your Digital Media Recorder.
- Both the Digital Media Recorder and the disc are coded by region. If the regional codes don't match, the disc cannot be played. This player is Region No. 1.
- Press STOP (the main menu appears). Check the PROG SCAN switch on the back of the unit to make sure it is in the OFF position. Try playing the disc again.
- If you're playing a Multisession CD, you might not have closed the session before ejecting it from your computer. Close the session and try the disc again.

Play starts, but then stops immediately

- The disc is dirty. Clean it.
- Condensation has formed in the Digital Media Recorder. Allow it to dry out.

The picture is distorted and/or fuzzy; or "jumps" during disc playback

- The disc might be damaged. Try another disc.
- It is normal for some distortion to appear during forward or reverse scan.
- The disc might be dirty. Clean it (go to page 52 for instructions)
- Some discs have defects that cause them to jump from one scene to the next.
- Turn the PROG SCAN switch on the back of the Digital Media Recorder to the "off" position. This switch should only be turned on if you've connected the Digital Media Recorder to a television that uses progressive scanning to display the image. Some, but not all High Definition Televisions (HDTVs) and multimedia monitors use progressive scan.
- If you have a progressive scan TV connected, a slight jumping of the signal is normal when you first play a DVD disc. A more detailed explanation follows:

If you have a progressive scan TV connected to the Digital Media Recorder via the COMPONENT jacks (Y, Pb, Pr) and turned on the PROG SCAN switch, the Digital Media Recorder automatically switches between progressive scan and regular interlace because progressive scan is only available when you play DVD discs. As the signal is converted from interlace to progressive (and vice versa), the Recorder resynchronizes the signal. Depending upon your TV, this resynchronization process might cause a slight "jump" in the picture when you start playing a DVD disc and again when you return to watching TV.

No sound or distorted sound

- Make sure your player is connected properly. Make sure all cables are securely inserted into the appropriate jacks.
- You may need to readjust the Digital Output setting (from the *Options* menu). Go to page 45. If you select DTS, and your Digital Media Recorder isn't connected to a DTS-capable receiver, you won't hear any sound, or the sound will be distorted.
- Turn your TV to its Video Input Channel (go to page 16).
- Sound is muted when you're using search features (fast forward, reverse, frame advance, etc.).
- If you connected an audio receiver to your Digital Media Recorder, make sure you chose the correct input setting on the receiver.

Can't advance through a movie

- You can't advance through the opening credits and warning information that appear at the beginning of movies because the disc is programmed to prohibit that action.

Subtitle and/or audio language is not the one selected from the initial setting

- If the subtitle and/or audio language does not exist on the disc, the disc's priority language will be selected instead. Set the subtitle and/or audio language manually through the Info Display or the Digital Media Recorder's menu system.

Play doesn't begin

- The rating of the title on the disc exceeds the rating limit set in the Ratings Limits menu. Unlock the player and/or change the rating limit in those menus. Go to page 47 for more information.

No forward or reverse scan

- Some discs have sections that prohibit rapid scanning, or title and chapter skip.
- If you're trying to skip through the warning information and credits at the beginning of a movie, you won't be able to. This part of the movie is often programmed to prohibit skipping through it.

Desired angle cannot be changed

- Most discs don't have the multi-camera angle system, and some discs only have multiple angles during certain parts of the movie.

Picture is too tall and thin

- Change the *Screen Format* in the menu system. Go to page 43 for more information.

Picture is too short and wide

- Change the *Screen Format* in the menu system. Go to page 43 for more information.

RECORDING/COPYING PROBLEMS

Not enough hours on the hard disk drive

- To get more recording time (space on the Digital Media Recorder's hard disk drive), you can change the Recording Quality setting (page 44).

Cannot copy discs to videotape

- You can't record DVD discs onto videocassettes because the discs are encoded with anti-copy protection. You may see a distorted picture on your VCR if you attempt to copy a protected disc.

Chapter 6: Additional Information

GUIDE PLUS+ SYSTEM

No listings

- If you have satellite TV service, the GUIDE Plus+ system won't list the programs.
- If you have a cable box, you must set up the G-LINK cable correctly (page 11), and complete the interactive setup (page 13).

Won't work with cable box

- You can't access pay-per-view programs via the GUIDE Plus+ system, and some other cable box features. Cable companies configure their boxes and services differently so it is difficult to know the specific solution. Contact your cable company.

The GUIDE Plus+ program guide goes blank when I highlight a channel/program

- If you've activated the V-Chip parental control feature in your TV and you are using the Digital Media Recorder's GUIDE Plus+ programming guide, you may have highlighted a channel in the guide that is rated higher than the settings in the TV's V-Chip. Just press the GUIDE button, and then use the Channel buttons to tune to another channel.

REMOTE CONTROL

Remote won't work

- You might be in the wrong mode. To operate your Digital Media Recorder, press DVD on the remote before you press any other buttons. If you're operating the TV, press the TV button first, etc. (this remote operates most RCA, GE, and Proscan TVs, and you can program it to operate other brands of televisions).
- Insert new batteries in the remote.
- Operate the remote control at a distance of no more than 20 feet.
- Remove any obstacles between the remote and the Digital Media Recorder or other component. If your Digital Media Recorder is in an entertainment cabinet, the glass doors might obstruct the remote control from operating the Digital Media Recorder. Open the doors.

Can't program the remote

- The universal remote control that came with your Digital Media Recorder is already programmed to operate most RCA, GE, and Proscan consumer electronics products. You can program it to operate many other brands and models of VCRs, TVs, cable boxes, and digital satellite receivers. Instructions are explained on page 19.

Lost the remote control

- To order a new remote control, go to page 59. The buttons on the front of the Digital Media Recorder operate the Digital Media Recorder's basic functions, but you won't be able to use the menu system without the remote control. The buttons on the front of the unit are described on page 55. Also, if you have another RCA, GE, or Proscan brand product with a remote control that has a DVD button, some of the buttons will probably operate this product if you press the DVD button first.

MP3 FILES

The following recommendations can't be taken as a guarantee that the Digital Media Recorder will play MP3 recordings, or as an assurance of sound quality. Certain technologies and methods for MP3 file recording on CD-R discs prevent optimal playback of these files on your product.

- Make sure the file is a true MP3 file. You can only play true MP3 files in the Digital Media Recorder – some products use software to compress MP3 files and convert them to other formats such as MPX. Your Digital Media Recorder won't recognize or play MPX files or other types of converted MP3 files.
- When naming MP3 files, don't exceed 12 characters, and enter .mp3 as the file extension. When using a general name format of: Title.mp3, make sure the title is 8 characters or less, don't use spaces, and don't use special characters (such as, =, +, /, %, &, etc.).
- Whatever the real recording capacity of the CD-R, don't use more than 630MB of recording space on the disc.
- Use a decompression transfer rate of at least 128 kb/sec (kilobits/second) when recording MP3 files. Sound quality with MP3 files basically depends on the rate of compression you choose. Getting audio CD quality sound requires an analog/digital sampling rate, that is conversion to MP3 format, of at least 128 kb/sec and up to 160 kb/sec. However, choosing higher rates like 192 kb/sec or more, only rarely give even better sound quality. Conversely, files with sampling rates below 128 kb/sec won't be played.

Can't get to Digital Media Recorder's main menu

- Press the STOP button until the main menu appears or press the left arrow button to return to the previous menu. If that doesn't work, remove the MP3 disc from the disc tray.

Can't make the Info Display appear

- The Info Display is only available when playing DVD discs, Audio CDs, Video CDs, and watching TV. The Info Display disappears automatically (times out)

Handling Cautions

- Before connecting other components to this Digital Media Recorder, be sure to turn all components off.
- Don't move the player while a disc is being played. The disc may get scratched or broken, and the player's internal parts may be damaged.
- Don't move the Digital Media Recorder while the power is on – you could damage the hard disk drive permanently.
- Don't put any container filled with liquid or any small metal objects on the Digital Media Recorder.
- Don't put your hand into the disc tray.
- Don't place anything other than the disc in the disc tray.
- Exterior influences such as lightning and static electricity can affect normal operation. If this occurs, turn the unit off and on again with the STANDBY•ON button, or disconnect and then reconnect the AC power cord to the AC power outlet. The unit should operate normally.
- Be sure to remove the disc and turn off the player after use.

Maintenance of Cabinet

For safety reasons, when cleaning the cabinet be sure to disconnect the AC power cord from the AC outlet.

- Do not use benzene, thinner, or other solvents for cleaning.
- Wipe the cabinet with a soft cloth.

Formation of Condensation

- Due to sharp changes in temperature and humidity, condensation may form if warm air comes in contact with any cold parts inside the player.
- When condensation forms inside the player, the player may not operate correctly. If this occurs, leave the player at room temperature until the inside of the player becomes dry and operational.
- If condensation forms on a disc, wipe the disc with a soft, dry cloth by moving the cloth from the center hole toward the outer edge.

Handling Discs

- Don't touch the disc's signal surfaces. Hold by the edges or by one edge and the hole in the center.
- Don't affix labels or adhesive tape to label surfaces. Don't scratch or damage the label.
- Do not use damaged (cracked or warped) discs.

Cleaning Discs

- Dirty discs can cause reduced video and audio performance. Always keep discs clean by wiping them gently with a soft cloth from the inner edge toward the outer perimeter.
- If a disc becomes very dirty, wet a soft cloth in water, wring it out well. Wipe the dirt away gently, and remove any water drops with a dry cloth.
- Do not use record-cleaning sprays or anti-static agents on discs. Also, never clean the discs with benzene, thinner, or other volatile solvents which may cause damage to the disc surface.

Chapter 6: Additional Information

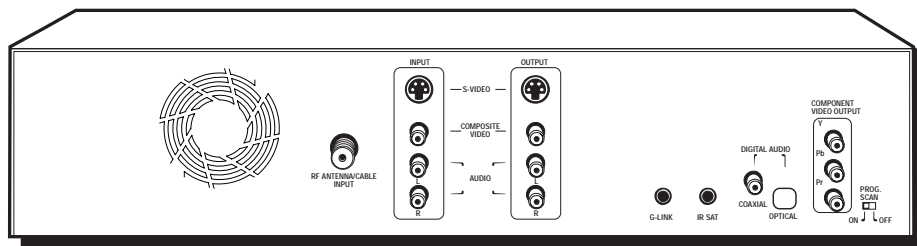

Back of the Digital Media Recorder

The back of your recorder might look a little overwhelming at first. This section explains what goes where and why. There are two sets of jacks on the back of your Digital Media Recorder – INPUT jacks and OUTPUT jacks.

Each jack is explained individually below, but the basic idea is about sending and receiving information to be played on or through your recorder and displaying that information on your TV screen. We call it Signal Flow.

INPUT Jacks bring the signal that carries the content INTO the Digital Media Recorder. Connecting the Input jacks on the DVD Recorder to corresponding output jacks on your TV is what makes it possible to record programs on your Digital Media Recorder and pause Live TV.

The Output Jacks are sending the signal from the Digital Media Recorder to the TV so you can see it on the screen. When you're playing a DVD, the Digital Media Recorder interprets the information on the disc and sends it to the TV so you can see it. It's the same idea with programs you've recorded to the hard drive of the Digital Media Recorder – the correct cables must be connected to the Digital Media Recorder's Output jacks and the corresponding Input Jacks on the TV so you can see the program on the TV.

Explanation of Jacks (from left to right)

RF ANTENNA IN: Connect an RF Coaxial cable from an off-air antenna, cable box, or cable outlet to this jack. The cable is sending the programming from the source to the DVD Recorder. Our connections show the cable coming from an RF Splitter (which enables you to watch one program on TV while you record another to your Digital Media Recorder's hard drive).

INPUT 1: These jacks receive audio and video from a compatible component, such as a satellite receiver. INPUT 2 jacks are on the front of the Digital Media Recorder.

S-VIDEO: If your satellite receiver has S-VIDEO, connect the S-Video cable to this jack because it provides better picture quality than standard composite video.

COMPOSITE VIDEO: Color coded yellow, the video cable you use with this jack provides better quality than an RF Coaxial cable but isn't as good as S-Video.

AUDIO L (left): Color coded white, connect corresponding audio cable to a compatible component such as a satellite receiver.

AUDIO R (right): Color coded red, connect corresponding audio cable to a compatible component such as a satellite receiver.

OUTPUTS (VIDEO, COMPOSITE VIDEO, AUDIO L, AUDIO R, COMPONENT VIDEO OUTPUT Y, Pb, Pr): These jacks send the content (audio and video) from your Digital Media Recorder (a disc, something you've saved on your Recorder's hard drive, or TV programming) OUT to the TV so you can see it on the TV screen and hear it through the TV's speakers. There are three video options: Composite Video, S-Video, and Component Video (for detailed explanation, go to page 56).

IR CABLE: If you have a cable box connected, connect the IR Cable (provided) to this jack in order for the Digital Media Recorder to control the cable box for timer recordings and program listings. For instructions, go to page 11.

IR SAT: If you have a satellite receiver connected, connect the IR Cable (provided) to this jack in order for the Digital Media Recorder to control the cable box for timer recordings and program listings. For instructions, go to page 11.

DIGITAL AUDIO (OPTICAL and COAXIAL)

Use one of these jacks to connect your Digital Media Recorder to a Dolby Digital or DTS receiver or decoder. Some receivers have either the COAXIAL or OPTICAL type of Digital Audio Input jack, and some have both. Under most conditions, optical and coaxial connections work equally well – the only difference is the type of cable you connect to the jack.

Rarely, but sometimes, coaxial digital cables – especially long ones, pick up radio frequency (RF) interference from household appliances, nearby power lines, and/or broadcast towers. If you want to use a less expensive cable, connect a coaxial cable to the COAXIAL jack if your receiver has a Coaxial input jack.



OPTICAL - connect an optical cable (SPDIF) to the OPTICAL jack on the Digital Media Recorder and Digital Audio Optical Input jack on your receiver.

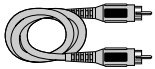

COAXIAL - connect a digital coaxial cable to this jack and to the Digital Audio Coaxial Input jack on your receiver. The cable is not a black coaxial cable, but an RCA-type cable.

PROG. SCAN switch - If you've connected your Digital Media Recorder to a TV that uses progressive scanning to display the image via the Y, Pb, Pr jacks, turn the switch to the "on" position for progressive scan playback of DVD discs. Typically, only some High Definition Televisions and high-end multimedia monitors use progressive scanning. Leave the switch in the OFF position for S-VIDEO or COMPOSITE VIDEO connections.

Note: If you turn the PROG SCAN switch on, and your TV isn't capable of progressive scanning you won't see a clear picture on the TV screen. Additionally, when playing DVDs you won't see any picture— press STOP (the main menu appears) and turn the PROG SCAN switch to the OFF position. Try playing the disc again.

Open the door to access the front audio video input jacks (INPUT 2).

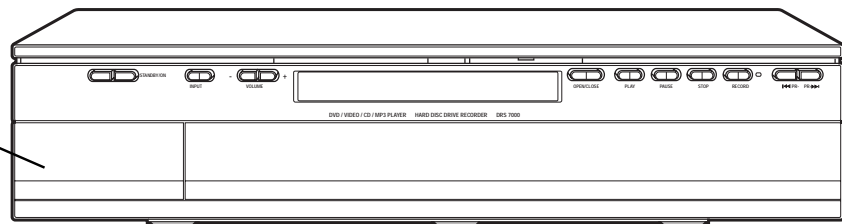

Front Panel Controls

Underneath the door:

INPUT 2: Audio/Video jacks - These Input Jacks are provided for convenient connection of a temporary component, such as a camcorder.

STANDBY/ON - Turns the digital media recorder on and off.

INPUT - Accesses different Video Input Channels (the "channel" to which you tune the DVD Recorder so you can see the signal coming from a component that is connected with cables to the different Input Jacks on the DVD Recorder). For example, if your camcorder is connected to the Audio and Video Input jacks on the front of the Digital Media Recorder (behind the door), you would press INPUT until *INPUT 2-Front* appears.

VOLUME + and - Increases or decreases the volume.

OPEN/CLOSE - Opens and closes the disc tray.

PLAY - Press to begin playback of a disc or content stored on the hard disk drive.

PAUSE - Pauses playback (also, pauses live TV).

STOP - Stops playback and/or recording.

RECORD - Records live TV.

CH- (channel down) - Goes to the previous channel in the channel list when you're watching TV. When playing a disc, goes to the beginning of the preceding title, chapter, or track on a disc.

CH+ (channel up) - Goes to the next channel in the channel list when you're watching TV. When playing a disc, goes to the beginning of the next title, chapter, or track on a disc (in effect, "skipping" the title, chapter, or track).

Chapter 6: Additional Information

Explanation of Input Jacks and Cables

This section describes the jacks and cables you can use to make connections (only audio/video cables are packed with your Digital Media Recorder – you can purchase cables by calling 1-800-338-0376, details are on page 62, or order online at www.rca.com, or go to your local electronics store). There are several ways to connect your Digital Media Recorder to your TV depending upon the cables you have and the jacks that are on the back of your TV.

Different jacks and cables provide a different level of performance. It's important to remember, we're talking about degrees of picture improvement for comparison. If your TV has Component jacks (Y, Pb, Pr), S-VIDEO, and composite video (often color-coded yellow and grouped with Audio Left and Right jacks that are white and red); Component (Y, Pb, Pr), would be considered excellent, S-Video would be very good, and the composite video jack (yellow) would be considered good.



Component Video (Y, Pb, Pr) Jacks and Cables

The Y, Pb, Pr jacks provide optimum picture quality because the video is separated into three signals (two signals are dedicated to the color portion of the image, and the other signal is dedicated to the black and white part of the image).

To ensure maximum picture quality, use three video-grade cables for the connection. There are bundled component video cables sold that are color-coded to match the Y, Pb, Pr jacks (red, green, and blue). Component Video Input jacks are usually found on Digital Televisions (HDTV).

Note: Also, remember to connect the left and right audio cables because the Y, Pb, Pr jacks and cables carry only the picture signal, not the sound.

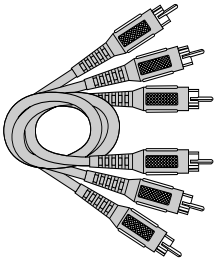

S-VIDEO



S-Video Jacks and Cables

The S-Video (separate video) jack provides better picture quality than a composite video jack (sometimes labeled VIDEO and color-coded yellow on TVs) because S-Video keeps the color (chrominance, also called chroma) part of the signal separate from the black and white (luminance) part of the picture.

S-Video cables are designed to keep the color information separated. If your TV has an S-VIDEO jack, connect the Digital Media Recorder to the TV with an S-Video cable (not provided) for a better quality picture.

Note: Remember to connect the left and right audio cables because the S-Video cable carries only the picture signal, not the sound.

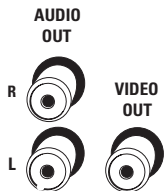

Audio/Video Jacks and Cables (RCA-type)

Audio

These jacks are used to send the audio from the disc you're playing in the Digital Media Recorder to the TV. The audio jacks and cables are often color-coded (red for right audio, and white for left audio). You must connect audio cables to the AUDIO L and R jacks on the Digital Media Recorder and the corresponding Audio Input Jacks on the TV no matter which Video jack you connect (VIDEO; S-VIDEO; Y, Pb, Pr)

Note: If your component has only one input for audio (mono), connect it to the left (white L/Mono) audio jack on the TV and don't connect the right audio part of the cable.

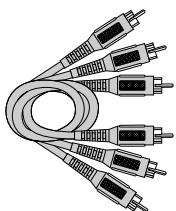

Video

The basic Video jack (usually color-coded yellow) is also referred to as composite video. Composite video doesn't keep color information separated (like S-Video), but it's better than the video quality you get from an RF coaxial cable (the type used to plug the cable feed into a TV).

Limited Warranty

What your warranty covers:

- Defects in materials or workmanship.

For how long after your purchase:

- One year from date of purchase for parts and labor.

The warranty period for rental units begins with the first rental or 45 days from date of shipment to the rental firm, whichever comes first.

What we will do:

- Pay any Authorized RCA Service Center the labor charges to repair your Digital Video Recorder.
- Pay any Authorized RCA Service Center for the new or, at our option, refurbished replacement parts required to repair your Digital Video Recorder.

How you get service:

- Take your Digital Video Recorder to any Authorized RCA Service Center. To identify your nearest Authorized RCA Service Center, ask your dealer, look in the Yellow Pages, or call 1-800-336-1900.
- Proof of purchase in the form of a bill of sale or receipted invoice which is evidence that the product is within the warranty period must be presented to obtain warranty service. For rental firms, proof of first rental is also required.
- Pick up your Digital Video Recorder when repairs are completed.

What your warranty does not cover:

- Acts of nature, such as but not limited to lightning damage.
- Adjustment of customer controls.
- Damage from misuse or neglect.
- A unit that has been modified or incorporated into other products or is used for institutional or other commercial purposes.
- Batteries.
- Units purchased or serviced outside the U.S.A.

Product Registration:

- Please complete the online Product Registration on RCA.com or complete and mail the Product Registration Card packed with your unit. It will make it easier to contact you should it ever be necessary. The return of the card is not required for warranty coverage.

Continued on next page

Chapter 6: Additional Information

Limitation of Warranty:

- THE WARRANTY STATED ABOVE IS THE ONLY WARRANTY APPLICABLE TO THIS PRODUCT. ALL OTHER WARRANTIES, EXPRESS OR IMPLIED (INCLUDING ALL IMPLIED WARRANTIES OF MERCHANTABILITY OR FITNESS FOR A PARTICULAR PURPOSE) ARE HEREBY DISCLAIMED. NO VERBAL OR WRITTEN INFORMATION GIVEN BY THOMSON INC., ITS AGENTS OR EMPLOYEES SHALL CREATE A WARRANTY OR IN ANY WAY INCREASE THE SCOPE OF THIS WARRANTY.
- REPAIR OR REPLACEMENT AS PROVIDED UNDER THIS WARRANTY IS THE EXCLUSIVE REMEDY OF THE CONSUMER. THOMSON INC. SHALL NOT BE LIABLE FOR INCIDENTAL OR CONSEQUENTIAL DAMAGES RESULTING FROM THE USE OF THIS PRODUCT OR ARISING OUT OF ANY BREACH OF ANY EXPRESS OR IMPLIED WARRANTY ON THIS PRODUCT. THIS DISCLAIMER OF WARRANTIES AND LIMITED WARRANTY ARE GOVERNED BY THE LAWS OF THE STATE OF INDIANA. EXCEPT TO THE EXTENT PROHIBITED BY APPLICABLE LAW, ANY IMPLIED WARRANTY OF MERCHANTABILITY OR FITNESS FOR A PARTICULAR PURPOSE ON THIS PRODUCT IS LIMITED TO THE APPLICABLE WARRANTY PERIOD SET FORTH ABOVE.

How state law relates to warranty:

- Some states do not allow the exclusion nor limitation of incidental or consequential damages, or limitations on how long an implied warranty lasts, so the above limitations or exclusions may not apply to you.
- This warranty gives you specific legal rights, and you also may have other rights that vary from state to state.

If you purchased your product outside the United States:

- This warranty does not apply. See your dealer for warranty information.

Note: RCA and/or Thomson multimedia are not responsible for loss of contents saved to the unit's hard disk drive, or any damages attached to the loss of contents stored to the hard disk drive.

Accessory Information

There are various accessories available to complement your Digital Media Recorder. Prices are subject to change without notice. All accessories are subject to availability.

A shipping and handling fee will be charged upon ordering, and we are required by law to collect the appropriate sales tax for each individual state, country, and locality to which the merchandise is being sent.

How to Order

To place an order by phone, have your Visa, MasterCard, or Discover Card ready and call the toll-free number listed below.

Use this number only to place an order for accessory items.

1-800-338-0376

You can buy some accessories on-line at www.rca.com

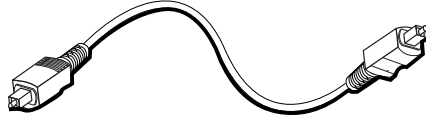

Optical Plug to Optical Plug for Optical Audio connection to a compatible receiver.

3 feet (part number DV3); price \$15.95

6 feet (part number DV6); price \$19.95



Optical Plug to Mini Plug

3 feet (part number DV3M); price \$15.95

6 feet (part number DV6M); price \$19.95

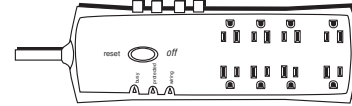

Surge Protector (part number SCTV 160), price \$49.95



Remote Control (RCR160DALM1) part number 257873

Chapter 6: Additional Information

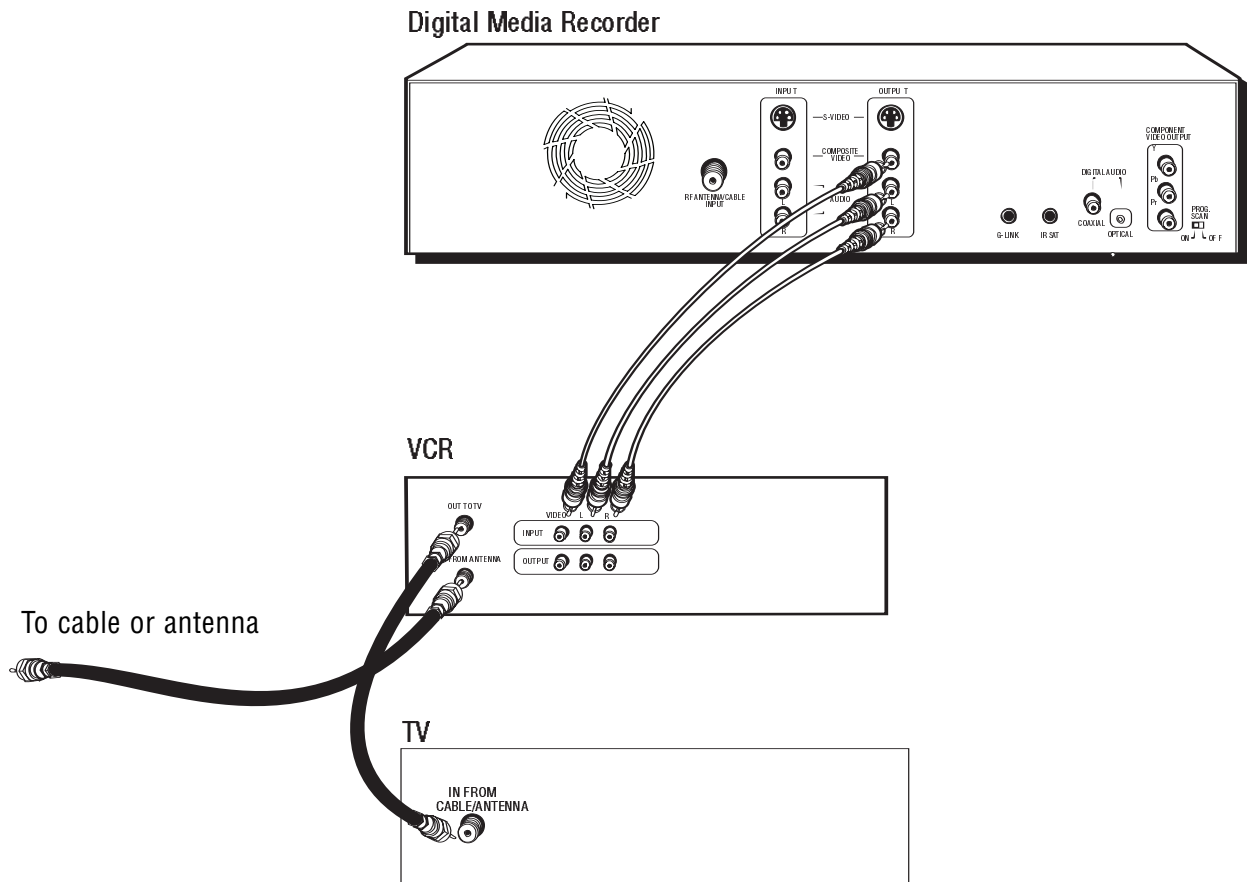

Copying content from the Digital Media Recorder to a VCR videocassette

The following instructions are provided for a general connection in case you might want to copy content from the Digital Media Recorder's hard disk drive to a VCR videocassette. The back of your TV and VCR probably don't exactly match the ones shown here. In general, you just need to connect the Digital Media Recorder's Output jacks to the VCR's Input Jacks. Also, you need to be able to see what your copying, so the TV needs to be connected.

1. Connect the Digital Media Recorder to the VCR.
 - 1a. Connect a set of audio/video cables to the Digital Media Recorder's OUTPUT COMPOSITE VIDEO (yellow), AUDIO L (white), and AUDIO R (red) jacks, to the VCR's Input Jacks (sometimes labeled VIDEO and AUDIO L and R).
2. Connect the VCR to the TV. Connect an RF coaxial cable to the OUT TO TV jack on the VCR and to the IN FROM CABLE/ANTENNA jack on the TV.
3. Make sure all of the components (TV, VCR, and Digital Media Recorder) are plugged into working power outlets.
4. Turn on all of the components.
5. Tune the TV to channel 3 or 4 (depending on whether the VCR's 3/4 switch is set to 3 or 4).
6. Change the channel on the VCR to its Video Input Channel (sometimes called LINE or LINE INPUT).
7. Access the menu in the Digital Media Recorder (*Video*, *Music*, or *Pictures*) that contains the content you want to copy.
8. Insert a working videocassette tape into the VCR.
9. Press the RECORD button on the VCR.
10. Start playback of the video, music, or pictures on the Digital Media Recorder that you want to record onto the VCR's videocassette.

This page intentionally left blank.

Visit our website at www.rca.com

Please do not send any products to the Indianapolis address listed in this manual or on the carton. This will only add delays in service for your product.

Thomson Inc.
10330 North Meridian Street
Indianapolis, IN 46290

©2003 Thomson Inc.
Trademark(s) ® Registered
Marca(s) Registrada(s)
Printed in Thailand
TOCOM 16166240

THOMSON

THOMSON 

Free Manuals Download Website

<http://myh66.com>

<http://usermanuals.us>

<http://www.somanuals.com>

<http://www.4manuals.cc>

<http://www.manual-lib.com>

<http://www.404manual.com>

<http://www.luxmanual.com>

<http://aubethermostatmanual.com>

Golf course search by state

<http://golfingnear.com>

Email search by domain

<http://emailbydomain.com>

Auto manuals search

<http://auto.somanuals.com>

TV manuals search

<http://tv.somanuals.com>