

VG4251



VCR User's Guide



We bring good things to life.

Important Information

WARNING

To reduce the risk of fire or shock hazard, do not expose this VCR to rain or moisture.

WARNING

RISK OF ELECTRIC SHOCK
DO NOT OPEN

TO REDUCE THE RISK OF ELECTRIC SHOCK, DO NOT REMOVE COVER (OR BACK). NO USER SERVICEABLE PARTS INSIDE. REFER SERVICING TO QUALIFIED SERVICE PERSONNEL.



This symbol indicates "dangerous voltage" inside the product that presents a risk of electric shock or personal injury.



This symbol indicates important instructions accompanying the product.

Cautions

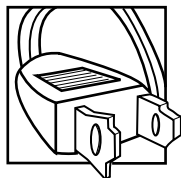

CAUTION: To reduce the risk of electric shock, match wide blade of plug to wide slot, fully insert.

ATTENTION: Pour éviter les chocs électriques, introduire la lame la plus large de la fiche dans la borne correspondante de la prise et pousser jusqu'au fond.

Refer to the identification/rating label on the back of the product for the proper operating voltage. FCC Regulations state that unauthorized changes or modifications to this equipment may void the user's authority to operate it.

Note To Cable TV Installer

This reminder is provided to call your attention to Article 820-40 of the National Electrical Code (Section 54 of the Canadian Electrical Code, Part 1) which provides guidelines for proper grounding and, in particular, specifies that the cable ground shall be connected to the grounding system of the building as close to the point of cable entry as practical.

Product Registration

Please fill out the product registration card and return it immediately. Returning this card allows us to contact you if needed.

Keep your sales receipt to obtain warranty parts and service and for proof of purchase. Attach it here and record the serial and model numbers in case you need them. The numbers are located on the back of the VCR.

Model No. VG4251

Serial No. _____

Purchase Date: _____

Dealer/Address/Phone: _____

Table of Contents

Important Information		Slow Motion_____ 14
Warnings_____ i		Automatic Tracking _____ 14
Cautions _____ i		Manual Tracking _____ 14
Note to Cable TV Installer _____ i		DISPLAY Button _____ 15
Product Registration _____ i		Time Counter _____ 15
		Commercial Scan _____ 16
Hooking Up the VCR		Index Search _____ 16
Choosing a Hookup _____ 2		Zero Search _____ 16
Antenna or Cable System Without a		Tape Playback: HI-FI/LINEAR/
Cable Box _____ 3		MIX Feature _____ 17
Cable System With Cable Box to		
Unscramble All Channels _____ 4		Recording a Program
Cable System With Cable Box to		Types of Recordings _____ 18
Unscramble Pay Channels Only _____ 5		Recording Speeds _____ 18
Connecting Two VCRs for Copying		Recording Pause _____ 18
Tapes _____ 6		Basic Recording –
		Operating Instructions _____ 19
Setting Up the VCR		Watch a TV Channel While VCR
Startup		is Recording a Different Channel ____ 19
Check Accessories With VCR _____ 7		One Touch Recording _____ 20
Insert Batteries in Remote _____ 7		Recording While You're Away
Turn on the TV _____ 8		Timer Recording _____ 21
Turn on the VCR _____ 8		Checking or Clearing
Place Channels in VCR's Memory ____ 8		Timer Recordings _____ 22
Add or Remove Channels from		Timer Recording From the
VCR's Memory _____ 9		VCR's Line Input _____ 22
Select a Language/Choisissez une		Recording Broadcast Stereo TV or SAP ____ 23
Langue _____ 9		Recording Audio Only _____ 24
Set the Time and Date _____ 9		Using Two VCRs for Copying
Use TV•VCR Button _____ 10		and Editing Tapes _____ 25
Set Auto TV/VCR Feature _____ 10		
Using the Remote Control		References
VCR Function Buttons _____ 11		Location of Controls
Playing a Tape		Front Panel _____ 26
Operating Instructions _____ 12		Back Panel _____ 27
Using the Playback Features		Display Panel _____ 28
Auto Play Feature _____ 13		Specifications _____ 29
Pause for Stop-Action _____ 13		Cleaning the VCR _____ 29
Picture Search _____ 13		Trouble Checks _____ 30-31
Frame Advance _____ 14		Limited Warranty _____ 32
		Index _____ 33

Choosing a Hookup

The hookups on pages 3 through 5 are divided into two hookup types: Basic (A) and Advanced (B).

The basic hookups show the backs of TVs that have only an antenna/cable connection. It is the easier of the two and additional accessories may not be needed.

The advanced hookups show the VCR hooked up to a monitor/receiver (TV with audio and video jacks). This connection may improve the picture quality as well as convenience of operation.

Answer the questions to choose the hookup for your VCR.

1. How do you receive your TV signals?

Choose one answer from below.

- A. Outside antenna – Turn to page 3.
- B. Rabbit ears (set-top) and/or bow tie antenna – Turn to page 3.
- C. Cable System – Go to question 2.

2. What type of cable-TV system* do you have?

Choose one answer from below.

- A. Cable without a box – Turn to page 3.
- B. Cable box to unscramble all the channels – Turn to page 4.
- C. Cable box to unscramble only pay channels, such as HBO, Showtime, Cinemax, etc. – Turn to page 5.

*You may need to contact your local cable company for assistance.

Optional Hookups

How to hook up two VCRs for copying tapes?

- A. Select a hookup by answering the questions above.
- B. Then modify the connections as shown on page 6.

Antenna or Cable System Without a Cable Box

A. Basic hookup.

Use this hookup for a simple connection which requires fewer accessories.

1. **Set the CH3 CH4 switch on back of VCR to either channel 3 or 4.**

You will tune the TV to this channel and use the TV•VCR button to watch the VCR.

2. **Connect as shown.**

This connection may require additional accessories not provided.

3. **Plug in power cords of VCR and TV.**

4. **Continue to page 7.**

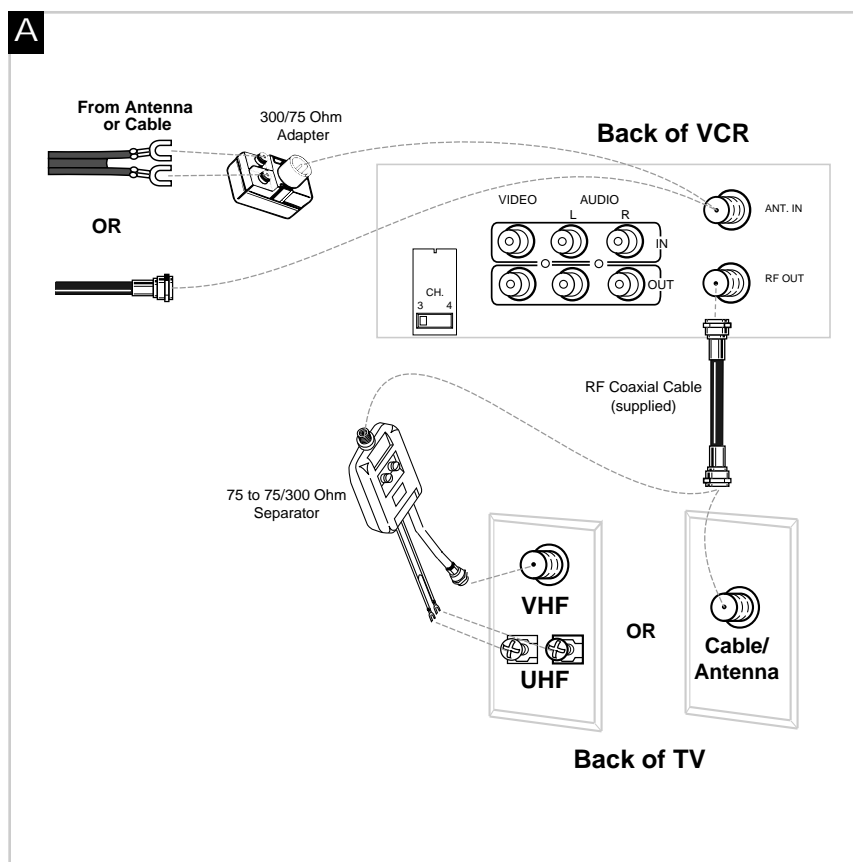

B. Advanced hookup.

Use this hookup for slightly improved picture quality, hi-fi stereo sound, and more convenient operation — use of TV•VCR button not required.

1. **Connect as shown.**

This connection requires additional accessories not provided.

If your TV is not stereo, you may need a Y-adapter to hear sound from both left and right channels.

2. **Plug in power cords of VCR and TV.**

3. **Continue to page 7.**

You will tune the TV to its video input to watch the VCR.

Set the Auto TV/VCR feature to OFF. See page 10.

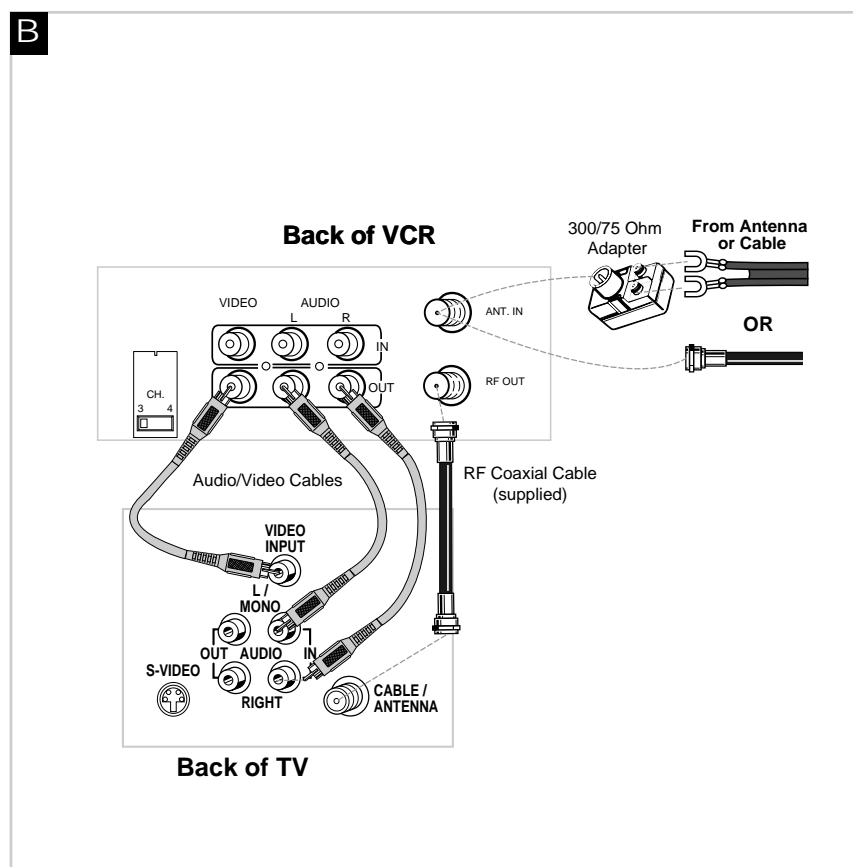

Cable System With Cable Box to Unscramble All Channels

A. Basic hookup.

Use this hookup for a simple connection which requires fewer accessories.

- Set the CH3 CH4 switch on back of VCR to either channel 3 or 4.**
You will tune the TV to this channel and use the TV•VCR button to watch the VCR.
- Connect as shown.**
This connection may require additional accessories not provided.
- Plug in power cords of VCR, TV, and cable box.**
- Continue to page 7.**

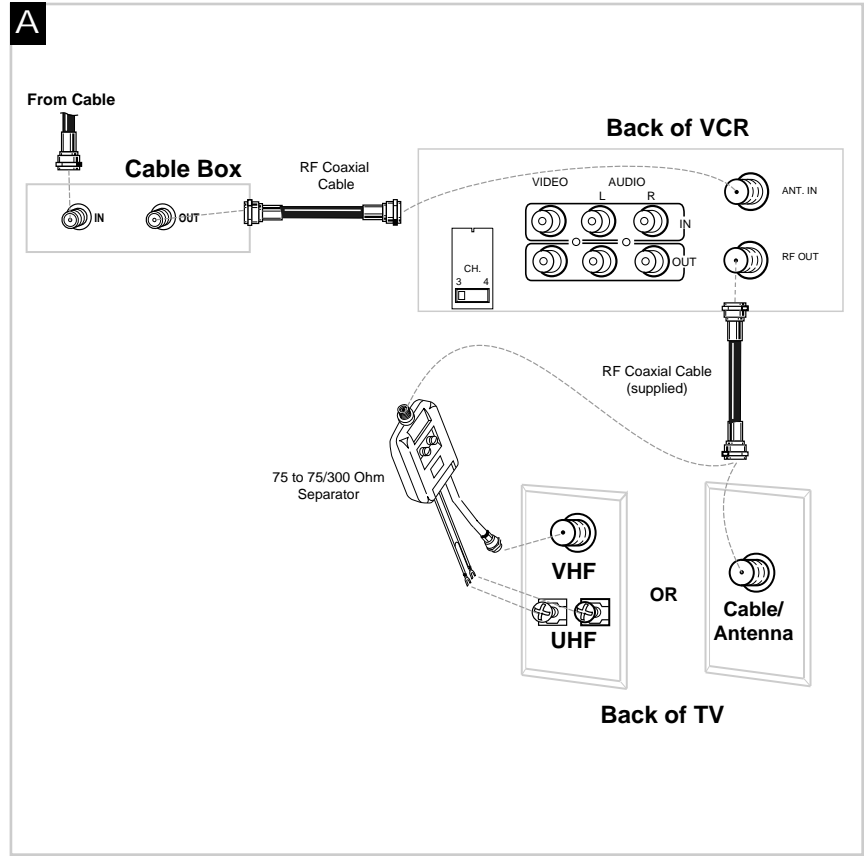

B. Advanced hookup.

Use this hookup for slightly improved picture quality, hi-fi stereo sound, and more convenient operation — use of TV•VCR button not required.

- Connect as shown.**
This connection requires additional accessories not provided.
If your TV is not stereo, you may need a Y-adapter to hear sound from both left and right channels.
- Plug in power cords of VCR, TV, and cable box.**
- Continue to page 7.**

You will tune the TV to its video input to watch the VCR.
Set the Auto TV/VCR feature to OFF. See page 10.

Caution: The unauthorized recording of satellite broadcasts, television programs, or other materials may infringe the rights of others.

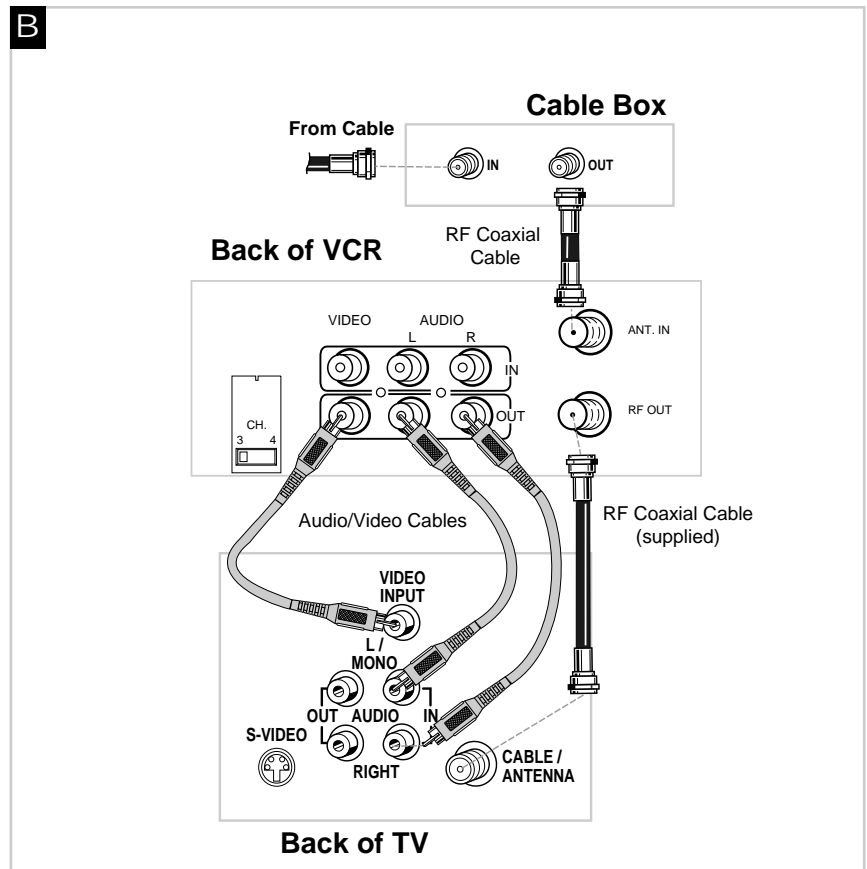

Hooking Up the VCR

Cable System With Cable Box to Unscramble Pay Channels Only

(such as HBO, Showtime, Pay-Per-View, etc.)

A. Basic hookup.

Use this hookup for a simple connection which requires fewer accessories.

1. **Set the CH3 CH4 switch on back of VCR to either channel 3 or 4.**

You will tune the TV to this channel and use the TV•VCR button to watch the VCR.

2. **Connect as shown.**

This connection may require additional accessories not provided.

3. **Plug in power cords of VCR, TV, and cable box.**

4. **Continue to page 7.**

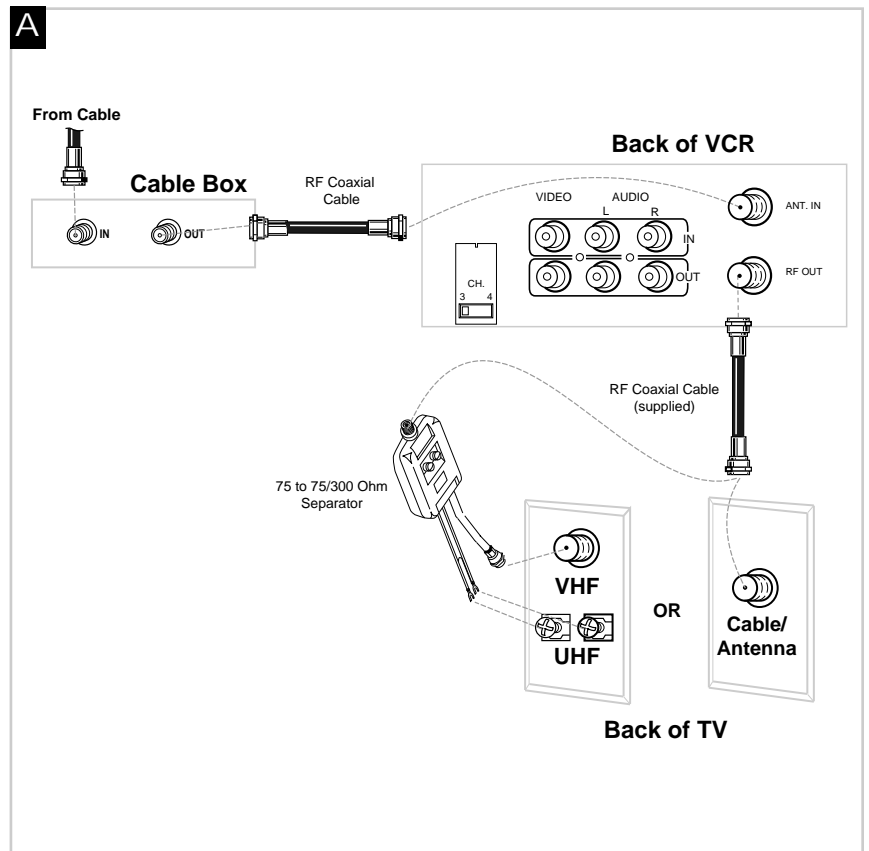

B. Advanced hookup.

Use this hookup for slightly improved picture quality, hi-fi stereo sound, and more convenient operation — use of TV•VCR button not required.

1. **Connect as shown.**

This connection requires additional accessories not provided.

If your TV is not stereo, you may need a Y-adaptor to hear sound from both left and right channels.

2. **Plug in power cords of VCR, TV, and cable box.**

3. **Continue to page 7.**

You will tune the TV to its video input to watch the VCR. All pay channels are viewed through the VCR.

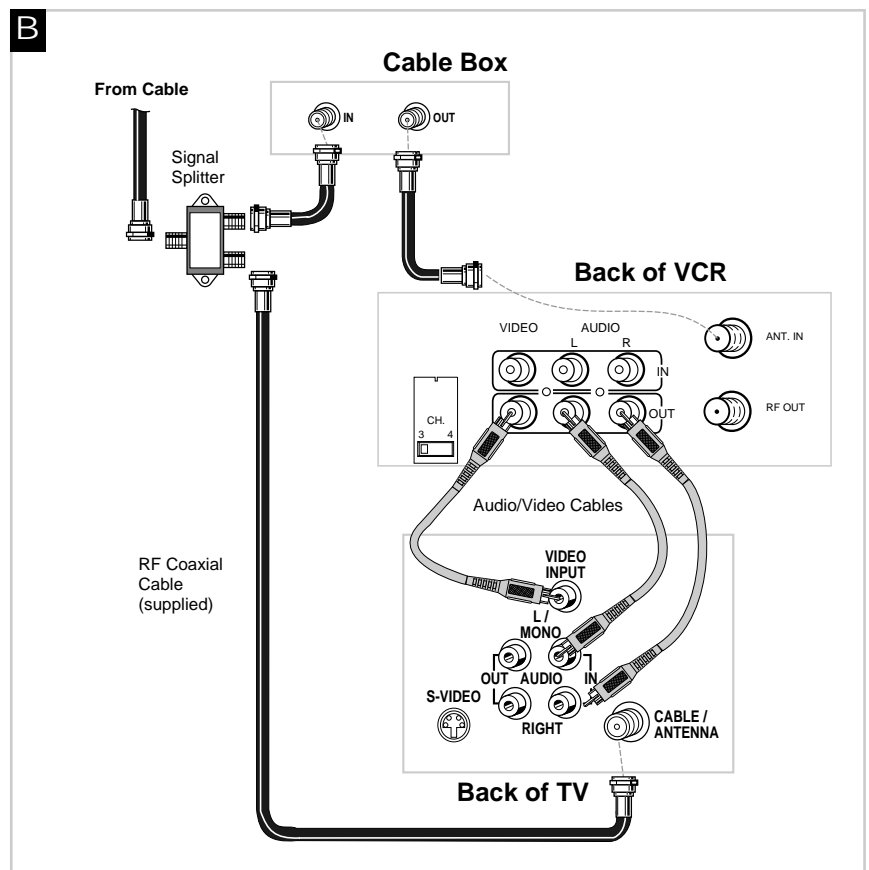

Connecting Two VCRs for Copying Tapes

Option A hookup.

Use this hookup for a simple connection which requires fewer accessories.

1. **Select a hookup from pages 2 through 5 and then modify with this connection.**
2. **Set the CH3 CH4 switch on the playback VCR to either channel 3 or 4.**
You will tune the recording VCR to this channel to receive the signal from the playback VCR.
3. **Connect as shown.**
This connection may require additional accessories not provided.
4. **Plug in power cords of VCRs and TV.**
5. **Continue to page 7.**

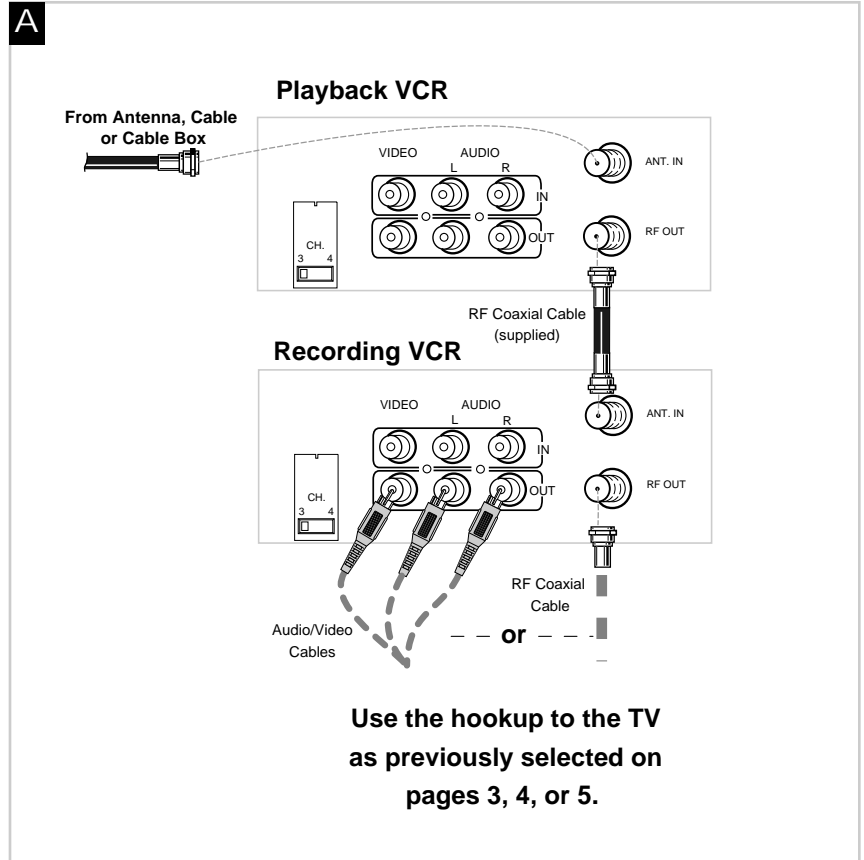

Option B hookup.

Use this hookup for slightly improved copy quality and more convenient operation — use of TV•VCR button not required.

1. **Select a hookup from pages 2 through 5 and then modify with this connection.**
2. **Connect as shown.**
This connection requires additional accessories not provided.
If your other VCR is not stereo, you may need a Y-adaptor to hear sound from both left and right channels.
3. **Plug in power cords of VCRs and TV.**
4. **Continue to page 7.**

You will select the line (audio/video) input on the recording VCR to receive the signal from the playback VCR.

Caution: The unauthorized recording of satellite broadcasts, television programs, or other materials may infringe the rights of others.

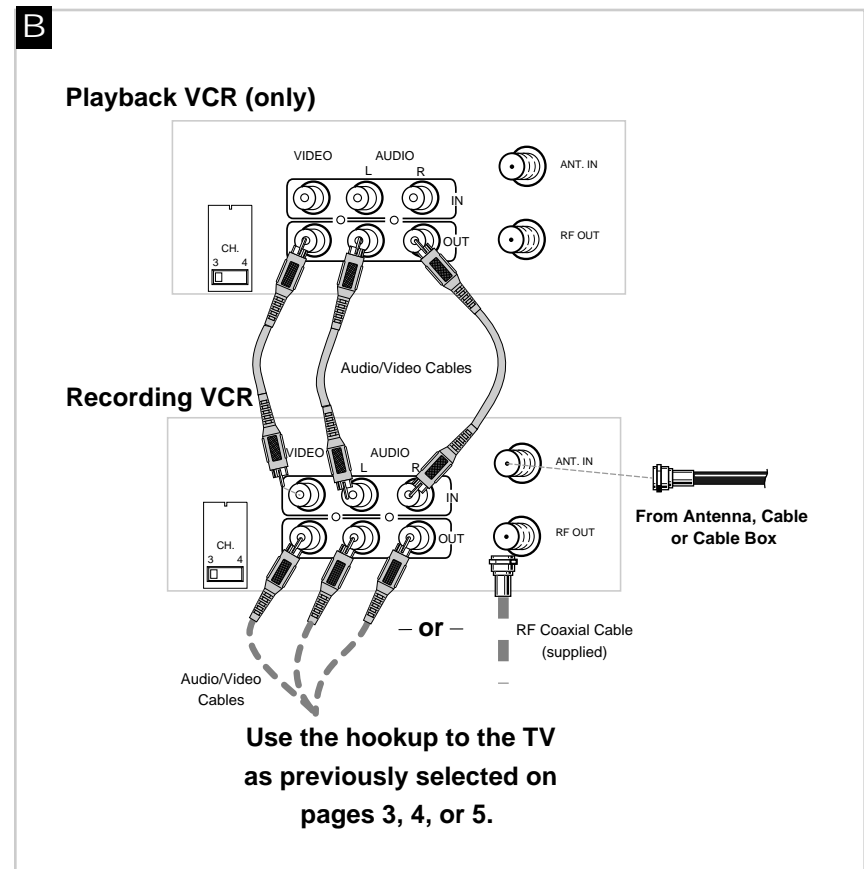

Startup

1. Check accessories with VCR.

Contact your dealer if any items are missing.

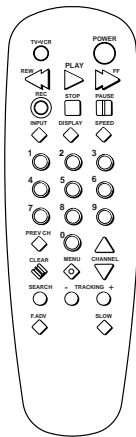

Remote
(Stock No. 221342)

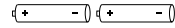

2 "AA" Batteries



RF Coaxial Cable
(Stock No. 221396)

2. Insert batteries in remote.

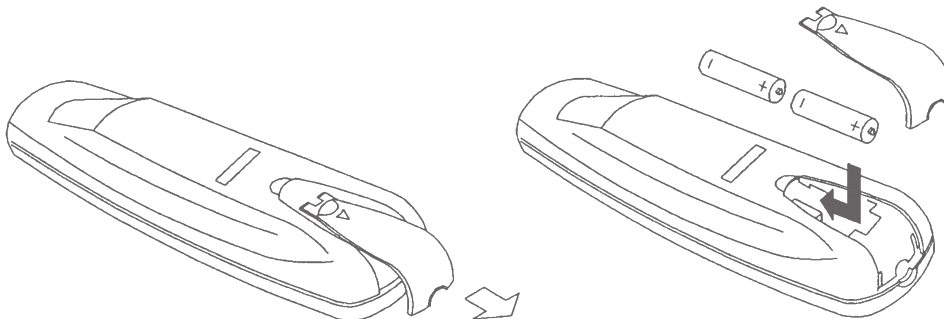

continued on next page

Startup

3. Turn on the TV.

- A. Turn on the TV.
- B. If you used one of the basic hookups, tune the TV to the channel selected with the CH3 CH4 switch on back of VCR.

If you used one of the advanced hookups, tune the TV to the TV's video input. (See TV owner's manual for details.)

4. Turn on the VCR.

- A. Press POWER on the remote.

5. Place channels in the VCR's memory.

The first time you turn on the VCR or after a power interruption, perform the AUTO CHANNEL SEARCH so that your VCR can locate the channels available through your signal type—cable or antenna. The signal type is automatically selected when you perform the AUTO CHANNEL SEARCH function. Also, if you change the signal type, you will need to perform AUTO CHANNEL SEARCH again.

- A. Press MENU to display the VCR MAIN MENU on the TV screen. If this menu does not appear:
 - Make sure TV is tuned to same channel as the CH3 CH4 switch on the back of the VCR or the TV's video input (refer to TV's manual).
 - Press MENU again.
 - If you use a basic hookup, check VCR indicator in display panel – it should be on. Press TV•VCR to turn it on.
 - Check the connections.
- B. Press 3 to display the CHANNELS menu.
- C. Press 1 to begin AUTO CHANNEL SEARCH.

The VCR automatically selects CABLE (cable TV) or ANTENNA. If you need to change the setting manually, press 3.

Wait until the channel numbers stop changing. This takes about one to two minutes. The TV will then tune to the lowest channel found. Pressing CHANNEL will select only the active channels.

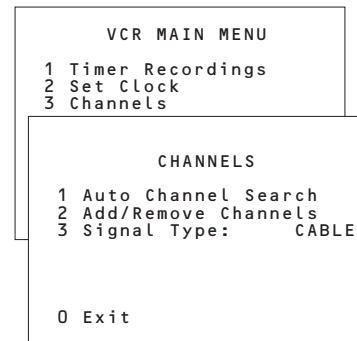
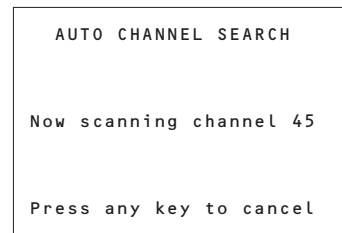

Startup

6. Add or remove channels from the VCR's memory.

You may want to add or remove channels if some of the channels are not active, have weak signals, or you do not want to watch them.

We recommend channels be placed in memory using the AUTO CHANNEL SEARCH feature *described on the previous page* before adding or removing channels. Channels 2-13 and VID1 were placed in memory at the factory.

- A. Press MENU on the remote to see the VCR MAIN MENU on the TV screen.
- B. Press 3 to display the CHANNELS menu.
- C. Press 2 to display the ADD/REMOVE CHANNELS menu.
- D. Follow the directions on the screen.
- E. Add or remove more channels by entering channel numbers or using CHANNEL up or down.

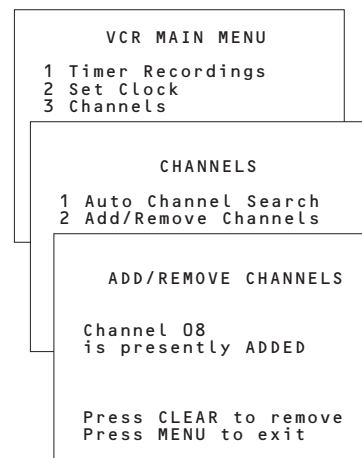

7. Select a language./Choisissez une langue.

You can select the language for the displays on the VCR.

- A. Press MENU on the remote to see the VCR MAIN MENU on the TV screen.
- B. Press 6 to display the LANGUAGE menu.
- C. Select English or French.
 - Press 1 to select English.
 - Press 2 to select Français (French).

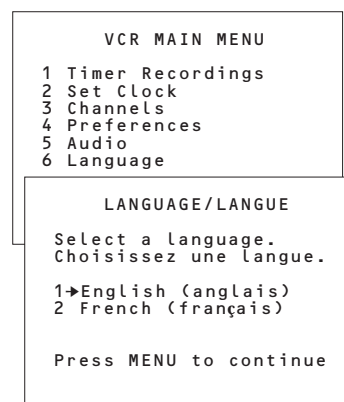

8. Set the time and date.

When you first turn on the VCR, --:-- appears in the clock area of the VCR's display panel.

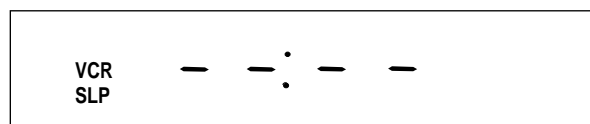

- A. Press MENU on remote to display the VCR MAIN MENU on the TV screen.
- B. Press 2 to display SET TIME AND DATE.
- C. Enter the time and date with the number buttons on the remote.
 - Press 0 before single-digit numbers.
Example: press 0, then 5, then 0, then 7 for a time of 5:07. Press 1 for AM or 2 for PM.
 - Press CLEAR on the remote to change incorrect entries.
- D. Press MENU on remote to remove SET TIME AND DATE from the TV screen and start the clock. The time will appear in the VCR's display panel and the time and date will appear on the TV screen when you press DISPLAY.

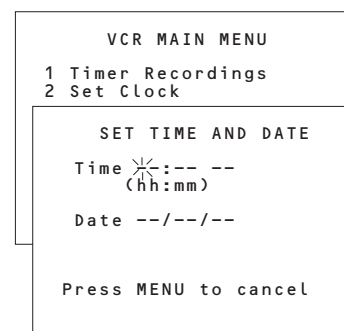

continued on next page

Startup

9. Use TV•VCR button.

Skip this step if you used one of the advanced hookups.

When using one of the basic hookups, the TV•VCR button lets you switch between the picture coming from the VCR or the picture from the TV channel. This button lets you record a program on the VCR while watching another channel on the TV. *Details are on page 19.*

- A. Press TV•VCR to see the picture from the VCR.
The VCR indicator lights in the display panel.
- B. Press CHANNEL up or down to change channels on the VCR.
The channel number changes in the display panel.
- C. Press TV•VCR to see the TV channels.
The VCR indicator does not light in the display panel. Change channels using the TV's remote.
- D. Return the TV to the VCR viewing channel — CH3 or CH4.
- E. Press VCR, then TV•VCR to switch back to the picture from the VCR.

10. Set Auto TV/VCR feature.

If you used one of the basic hookups and did not connect the audio/video jacks of the VCR to the TV, leave the Auto TV/VCR feature set to ON.

If you have connected your VCR using the audio/video input of your TV, you can prevent the VCR indicator from turning on automatically and interrupting the cable or antenna signal to your TV.

- A. Press MENU on the remote to see VCR MAIN MENU on the TV screen.
- B. Press 4 to display PREFERENCES.
- C. Press 2 to select Auto TV/VCR: ON or OFF.
 - Select ON if you used one of the basic hookups and watch the VCR on channel 3 or 4 of your TV. The VCR will automatically switch the TV•VCR setting to VCR every time the VCR is turned on, a tape with the safety tab removed is inserted, or you press PLAY.
 - Select OFF if you used one of the advanced hookups and watch your VCR on the video input channel of your TV. The VCR indicator will not turn on automatically and the signal from your antenna or cable to your TV will not be interrupted. Pressing TV•VCR on the remote will still turn the VCR indicator on or off and switch the antenna signal.

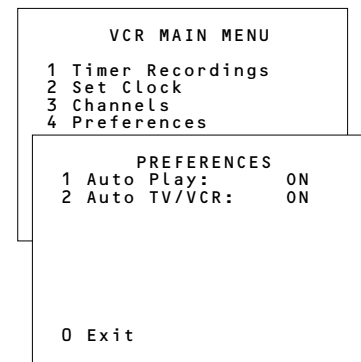

VCR Function Buttons

VCR Function Buttons

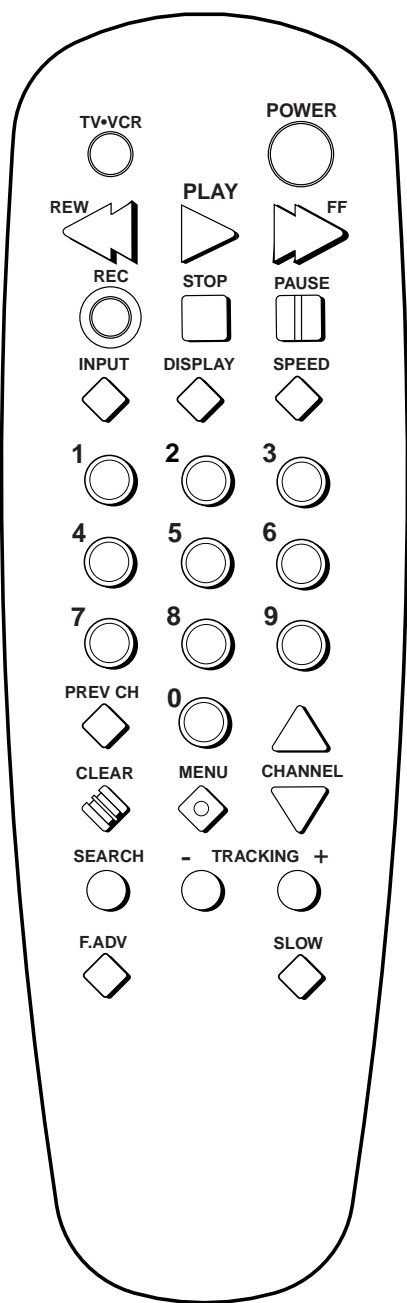

CHANNEL Up or Down

Selects next higher or lower channel in the VCR's channel memory.

CLEAR

Resets time counter to 0:00:00.

Allows you to change entries when setting the clock or VCR for a timer recording.

DISPLAY

Shows VCR operating displays on the TV screen.

Displays the time counter.

F.ADV (Frame Advance)

Lets you view one frame with each press of the button while the tape is paused.

FF (Fast Forward)

Fast forwards the tape when the VCR is stopped.

Searches the picture in forward motion during playback.

INPUT

Turns the line input on or off. VID1 appears in VCR's display panel and VIDEO appears on TV screen.

Line input refers to the signal coming from the component connected to the AUDIO/VIDEO IN jacks on the back of the VCR.

MENU

Displays the VCR MAIN MENU on the TV screen.

Removes a menu from the screen.

Numbers (0 through 9)

Select a channel up to 99 by pressing two numbers.

Select a cable channel over 99 by pressing and holding 1 until 1-- appears on the screen. Then press the other two numbers.

PAUSE

Pauses action for viewing during playback.

Pauses recording to prevent recording of unwanted scenes.

PLAY

Plays a tape.

POWER

Turns the VCR on and off.

PREV CH (Previous Channel)

Switches between two channels.

Select one channel and then use the number buttons to select another. Press PREV CH to switch between the two channels.

REC

Starts VCR recording.

Used for one touch recording . See page 20.

REW (Rewind)

Rewinds the tape when the VCR is stopped.

Searches the picture in reverse motion during playback.

SEARCH

Displays INDEX and ZERO SEARCH menus on TV.

Lets you advance tape 60 or 120 seconds during playback.

SLOW

Used for slow-motion playback.

SPEED (Tape Speed)

Selects a recording speed (SP or SLP).

STOP

Stops the normal functions such as record, playback, rewind, fast forward, and pause.

TRACKING - and +

Lets you manually reduce the streaks that may appear on the picture during play or pause.

TV•VCR

Switches the picture signal so that it either comes from the VCR or the TV channel. See page 10.

Operating Instructions

To Play a Tape

1. Turn on the TV and tune it to channel 3, 4, or TV's video input to see the picture from the VCR.

2. Insert a tape in the VCR.

VCR automatically turns on. The cassette-in indicator  lights, and the VCR indicator lights if the Auto TV/VCR feature is set to ON. The tape automatically begins playback if the safety tab on the cassette has been removed and the Auto Play feature is turned on.

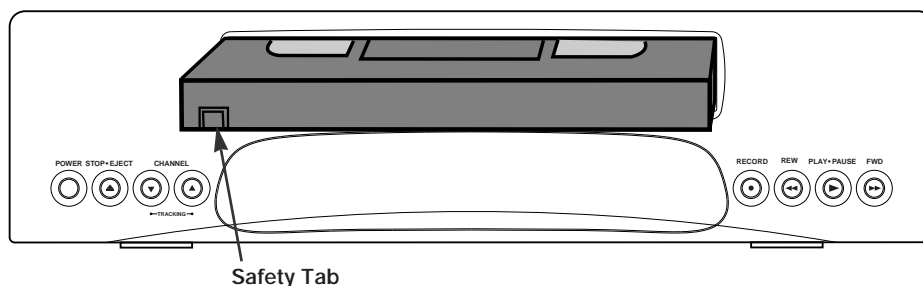

3. Press PLAY on the remote or PLAY•PAUSE on the VCR, if necessary. PLAY appears in the VCR's display panel.
4. Press TRACKING up or down to remove any streaks from the picture, if necessary. *Details are on page 14.*
5. Press STOP on the remote or STOP•EJECT on the VCR.
6. Press REW. REW will appear in the VCR's display panel.
The VCR will automatically rewind the tape if it reaches the end of the tape during playback. While rewinding, you can press POWER and the VCR will turn off after rewinding.
7. Press STOP•EJECT on the VCR to eject the tape once it is completely rewound.

Using the Playback Features

Auto Play Feature

This feature lets you tell the VCR whether you want it to automatically start playing a tape that is inserted with the safety tab removed.

1. Press MENU on the remote to see the VCR MAIN MENU on the TV screen.
2. Press 4 to display the PREFERENCES menu.
3. Press 1 to select Auto Play: ON or OFF.
 - Select ON to have a tape with its safety tab removed start playing automatically.
 - Select OFF if you do not want a tape with its safety tab removed to start playing automatically.

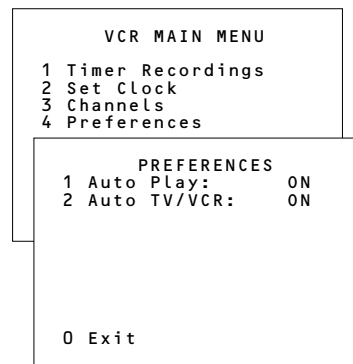

Pause for Stop Action

This feature stops the tape in action and allows you to examine the details of the scene. Stop action works best for tapes recorded in the SP and SLP speed.

1. Press PAUSE on the remote or PLAY•PAUSE on the VCR during playback to stop the action.
PAUS appears in the VCR's display panel.
Press TRACKING up or down during stop-action pause to reduce picture "jitter".
2. Press PLAY•PAUSE on the VCR or PLAY on the remote to return to playback.
The VCR will automatically switch from stop-action playback to stop after a few minutes.

Picture Search

You can search a picture during playback by fast forwarding or rewinding the tape. Sound is turned off during picture search. Picture search works best for tapes recorded in the SP and SLP speed.

Fast Forward Search

1. During playback, press FF on the remote or FWD on the VCR to search forward at a faster-than-normal speed.
SRCH+ appears in the VCR's display panel.
2. To return to playback, press FF or FWD, PLAY on the remote, or PLAY•PAUSE on the VCR.

Rewind Search

1. During playback, press REW to search in reverse at a faster-than-normal speed.
SRCH- appears in the VCR's display panel.
2. To return to playback, press REW, PLAY on the remote or PLAY•PAUSE on the VCR.

Using the Playback Features

Frame Advance

Frame advance lets you view one stop-action frame after another. Frame advance works best for tapes recorded in the SP or SLP speed.

1. Press PAUSE to stop the action.
PAUS appears in the VCR's display panel.
2. Press F.ADV each time you want to view a frame of the scene.
3. Press PAUSE or PLAY on the remote or PLAY•PAUSE on the VCR to resume normal playback.

Slow Motion

You can view the picture in slow motion during play or play pause. Sound is turned off during slow-motion playback. Slow motion works best in the SP or SLP speed.

1. During playback, press SLOW to start slow-motion playback.
SLOW appears in the VCR's display panel.
2. Use TRACKING up or down to remove any streaks from the picture.
3. Press PLAY on the remote or PLAY•PAUSE on the VCR to return to playback.
The VCR will automatically switch from slow-motion playback to stop after a few minutes.

Automatic Tracking

The VCR has automatic tracking which adjusts the picture when playing back a tape recorded on another VCR. Automatic tracking is turned on whenever a tape is inserted or the VCR's power is turned on.

Manual Tracking

Occasionally, you may need to manually adjust tracking on a tape recorded on a different VCR or camcorder. The TRACKING buttons on the remote or VCR are used when playing a tape. They have no effect during recording.

- When streaks or snow appear, press TRACKING up or down for the best possible picture.
- Press TRACKING up or down during stop-action pause to reduce picture "jitter".
- Press both TRACKING buttons on the VCR at the same time to turn automatic tracking back on or eject the tape and re-insert it.

Using the Playback Features

DISPLAY Button

1. Press DISPLAY to display the status of the VCR, channel number, time counter, date, time, and tape speed on the TV screen. The VCR status will appear in the display panel.
The time and date must be set before they are displayed. If you do not press DISPLAY again, these displays will time out.
2. Press DISPLAY again to have only the time counter remain on the TV screen. The time counter will appear instead of the time in the VCR's display panel.
3. Press DISPLAY again to remove the time counter from the TV screen.
The time counter will remain in the VCR's display panel.
4. Press DISPLAY again to return to the normal status displays.
The time will appear in the VCR's display panel.
Turning off the VCR automatically returns the displays to normal.

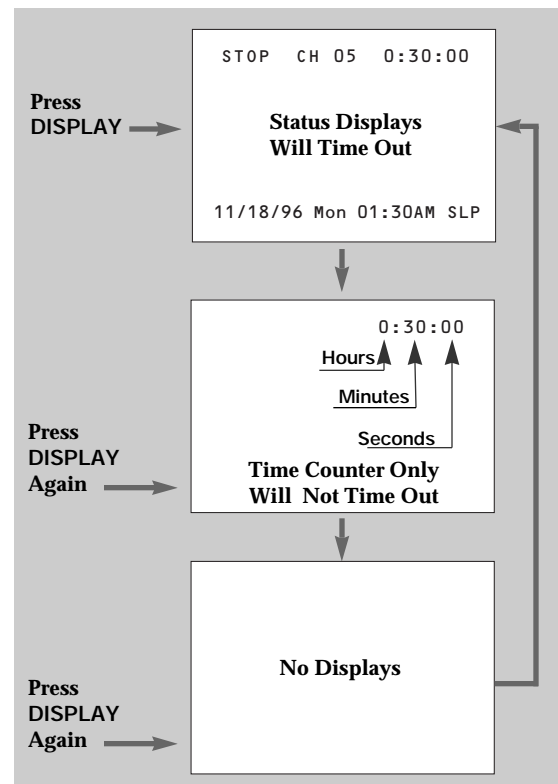

Time Counter

The time counter shows the elapsed time it takes to record a program or play back a segment of a prerecorded tape. It helps locate the beginning or end of programs you taped. The time counter resets to 0:00:00 whenever the tape is ejected from the VCR.

For example, if a 30-minute program was recorded at the beginning of the tape, you would:

1. Insert the prerecorded tape. Make sure the tape is rewound. Press STOP on the remote or STOP•EJECT on the VCR.
2. Press DISPLAY twice to display only the time counter on the TV screen.
3. Press CLEAR to reset the time counter to 0:00:00.
4. Press FF on the remote or FWD on the VCR to fast forward the tape until the time counter reads 0:30:00. Press STOP on the remote or STOP•EJECT on the VCR.
This is the approximate end of the program and you can begin recording at this spot.
5. Press DISPLAY to remove the time counter from the screen and return to the normal displays.

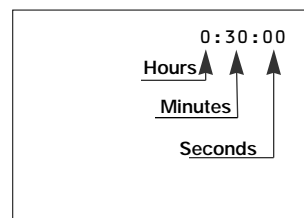

Using the Playback Features

Commercial Scan (SEARCH Button)

This is useful for scanning commercials or short program segments.

1. Press SEARCH once during playback to advance the tape approximately 60 seconds.
2. Press SEARCH twice during playback to advance the tape approximately 120 seconds.
SRCH+ appears in the VCR's display panel.

Index Search

The VCR has a "VHS Index Search System" that automatically records an index mark on the tape every time you begin recording a program. During playback you can locate the program you want to play by the number of index marks.

The VCR will automatically locate the index number you select. The VCR will search forward or reverse from the location you are on the tape.

1. Insert the prerecorded tape and press STOP.
2. Press SEARCH on the remote to display the INDEX SEARCH menu on the TV screen.
3. Press FF or REW to search for the next index mark or press two number buttons to enter the specific index mark you want the VCR to search for.

Press CLEAR to correct an entry.

4. Press FF to search forward or press REW to search in reverse.
5. Press STOP to stop index searching.

Some index marks may be missed by the VCR.

- A mark too close to your location on the tape.
- The mark at the beginning of a recorded segment of five minutes or less.
- The first index mark on the tape when you start at the beginning of the tape.

```
INDEX SEARCH
Press REW or FF
to begin scanning
OR
Enter a specific
Index number
  / \
Press SEARCH to exit
```

```
INDEX SEARCH

Searching for
Index number
  03
Press STOP to cancel
```

Zero Search

The zero search feature allows you to quickly return to a counter reading of 0:00:00 at any spot on the tape. This is convenient when you want to watch a segment of the tape several times.

1. Insert the prerecorded tape and press STOP.
2. Press DISPLAY twice to display only the time counter on the TV screen.
3. Locate the point on the tape that you want to return to quickly.
4. Press CLEAR to reset the time counter to 0:00:00.
5. You can continue to play the tape or perform other functions. When you are finished, press STOP.
6. Press SEARCH twice to display the ZERO SEARCH menu. The current tape counter is displayed.
7. Press REW to return to 0:00:00. When the VCR reaches 0:00:00 it will begin playback.

If the time counter reading has a minus (-) in front of it, press FF on the remote or FWD on the VCR to return to a reading of 0:00:00.

8. Press STOP to stop zero search.

```
ZERO SEARCH

Current tape counter is
  2:17:25
Press REW to go to
  0:00:00
Press SEARCH to exit
```

-OR-

```
ZERO SEARCH

Current tape counter is
 -2:17:25
Press FF to go to
  0:00:00
Press SEARCH to exit
```

Using the Playback Features

Tape Playback: HI-FI/LINEAR/MIX Feature

The VCR records the same audio on both the hi-fi and linear tracks on the tape. The hi-fi stereo sound is recorded on separate left and right stereo channels. Monaural sound is recorded on the linear track.

To enjoy hi-fi sound, connect your VCR to a stereo television or amplifier/receiver using the audio/video jacks. The Tape Playback: HI-FI/LINEAR/MIX feature lets you select which audio you play back.

To Select Playback Sound

1. Press MENU to see the VCR MAIN MENU on the TV screen.
2. Press 5 to see the AUDIO menu on the TV screen.
3. Press 2 to switch between HI-FI, LINEAR, or MIX sound.
 - Select HI-FI to play back sound recorded on the hi-fi track and for normal use.

The HI-FI indicator is lit in the VCR's display panel during hi-fi playback.
 - Select LINEAR to play back the sound recorded on the linear monaural track – used to playback a second audio program (SAP).
 - Select MIX to play back the sound recorded on both the linear track and the hi-fi track, sound-on-sound.

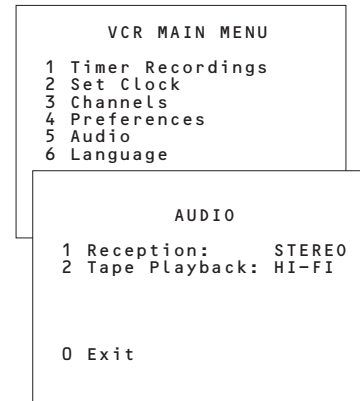

Types of Recordings

Your VCR provides different types of recording. These types are explained in the following sections:

Basic Recording – Operating Instructions

One Touch Recording

Recording While You're Away

Timer Recording

Recording Broadcast Stereo TV or SAP (Second Audio Program)

Recording Audio Only

Using Two VCRs for Copying Tapes

Using the Recording Features

Recording Speeds

Press **SPEED** on the remote to select a recording speed (SP or SLP). The speed you select appears on the TV screen and in the VCR's display panel. The VCR automatically selects the playback speed (SP, LP, or SLP).

Cassette Type	Recording Time	
	SP	SLP
T120	2Hr	6Hr
T160	2Hr 40Min	8Hr

SP (Standard Play) gives the best quality recording. That is why most prerecorded, rental tapes are recorded in SP. Fewer programs can be recorded on the tape. Special effects such as pause, slow motion, picture search, and frame advance work well.

SLP (Super Long Play) gives three times the recording time of tapes recorded in SP. Special effects such as pause, slow motion, picture search, and frame advance work well.

Recording Pause

This feature allows you to prevent recording short passages of unwanted material.

Press **PAUSE** during recording to stop and start recording. **REC.P** appears in the VCR's display panel.

The VCR will automatically switch from pause to stop after a few minutes.

Types of Recordings

Basic Recording – Operating Instructions

To Make a Recording

Turn on the TV and tune it to the VCR viewing channel, either 3, 4, or TV's video input channel.

1. Insert a tape with safety tab in place.
The cassette-in indicator  lights in the VCR's display panel.
2. If using one of the basic hookups, make sure the VCR indicator appears in the VCR's display panel. If not, press TV•VCR to turn it on.
3. Select recording speed using SPEED on the remote.
The tape speed indicator appears in the VCR's display panel and on the TV screen.
4. Select the channel to be recorded.
The channel number appears in the VCR's display panel and on the TV screen.
5. Press REC on the remote or RECORD on the VCR to begin recording. REC appears in the VCR's display panel while the VCR is recording.

Watch a TV Channel While VCR is Recording a Different Channel

1. Follow steps 1 through 5 above.
2. If using one of the basic hookups, press TV•VCR to switch to the TV channel. The VCR indicator will turn off in the display panel.
3. Select the channel you want to watch with the TV's channel buttons.
4. Press STOP on the remote or STOP•EJECT on the VCR when recording is finished.

One Touch Recording

One touch recording lets you record up to four hours without using the timer program feature. The VCR will turn off automatically at the end of the recording.

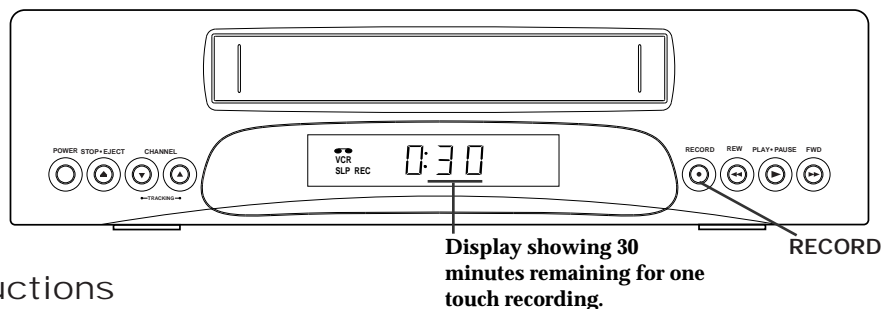

Operating Instructions

1. Turn on the VCR.
2. Insert a tape with safety tab in place.
3. Select the channel you want to record.
4. Select the desired recording speed using SPEED on the remote.
5. Press REC on the remote or RECORD on the VCR twice to activate one touch recording.
6. Press REC or RECORD repeatedly until the amount of recording time for the program is displayed in the VCR's display panel or on the TV screen.

	Press RECORD	Recording Time
<p>REC Ch 11 Record Length 0:30</p> <p>Press REC to set Length</p>	0:30	(30 Min)
	1:00	(1 Hr)
	1:30	(1 Hr, 30 Min)
	2:00	(2 Hrs)
	3:00	(3 Hrs)
	4:00	(4 Hrs)
One Touch Display on TV Screen		(Normal Recording)

Each press increases the time — 30 minutes up to four hours.

The amount of time the VCR will record and REC will appear in the VCR's display panel.

You can increase the amount of recording time by pressing REC or RECORD.

Stopping a Recording in Progress

Press and hold STOP on the remote or STOP•EJECT on the VCR for approximately three seconds.

Recording While You're Away (Timer Recording)

The timer program feature lets you program the VCR to record up to eight different programs within a one year period. Before setting the timer, make sure that:

- The clock is set correctly.
- A tape with safety tab has been inserted with enough tape to record the programs.

Setting a Timer Recording

1. Press MENU on remote to display VCR MAIN MENU.
2. Press 1 to display TIMER RECORDINGS menu.
3. Press 1 to display Create a New Program menu.
4. Press 1, 2, 3, or 4 to select type of program.
 - 1 One time — single program recorded once.
 - 2 Daily — program recorded at same time every day.
 - 3 Weekdays — program recorded at same time Monday through Friday.
 - 4 Weekly — program recorded at same time once a week.
5. Press number buttons on the remote to enter the channel number (use INPUT or 0, 0 to select video input), start time including AM or PM, end time, and start date of the recording. Just follow the on-screen prompts. Press CLEAR to correct an entry.
6. Press SPEED on the remote to change recording speed.
7. Press MENU to enter your program. A reminder appears which will time out or you can press MENU to return to the VCR MAIN MENU.

PROGRAMS OVERLAP may appear on the screen if you have entered two programs where the times overlap.
8. The TIMER RECORDINGS menu appears. Press 1 to enter an additional timer program, or press 0 to exit.
9. **Turn off the VCR** before recording begins. TIMER appears in the VCR's display panel when the timer has been programmed.
10. **If using a cable box, leave it turned on and tuned to the channel you want to record.**

Stopping a Recording in Progress

Press and hold STOP on the remote or STOP•EJECT on the VCR for approximately three seconds.

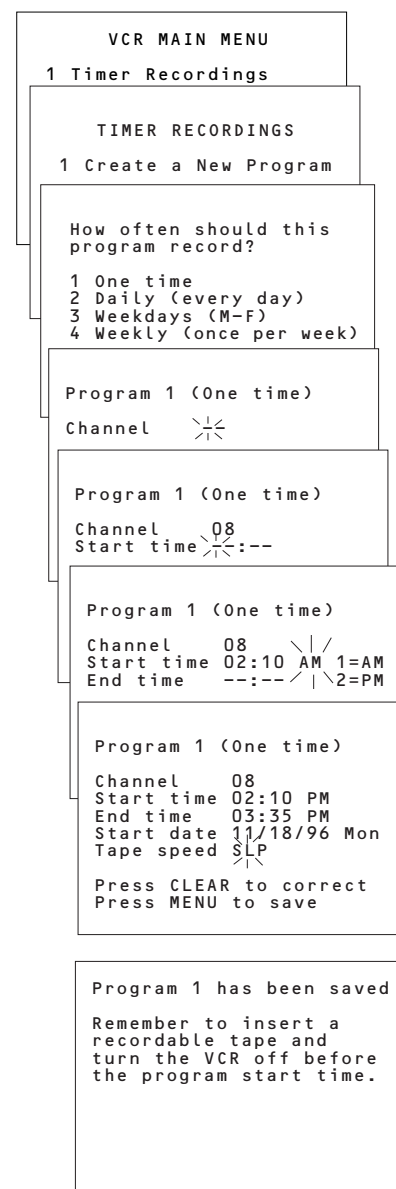

Recording While You're Away

Checking or Clearing Timer Recordings

1. Press MENU on remote to display VCR MAIN MENU on TV screen.
2. Press 1 to display the TIMER RECORDINGS menu.
3. Press 2 for Review Existing Progs. feature.
4. Press MENU to display information for the next program.
5. Press CLEAR when the program you want to erase appears on the screen.

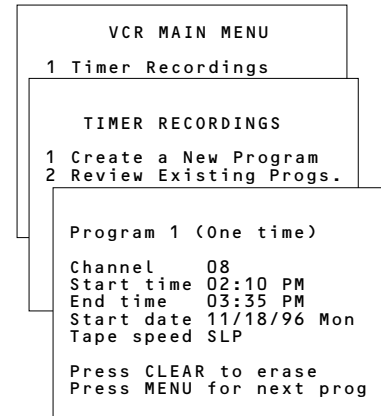

Timer Recording From the VCR's Line Input

The line input refers to the signal coming from the AUDIO and VIDEO IN jacks of the VCR. Recording from the line input is convenient if you have a satellite receiver or similar component attached to these jacks. To timer record from the component connected to the VCR's line input:

Press INPUT (or 0,0) to select VIDEO in place of the channel number on the TV screen during timer programming.

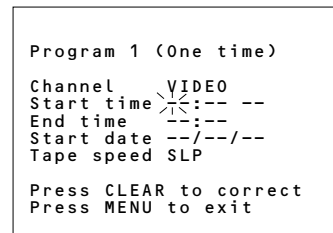

Recording Broadcast Stereo TV or SAP (Second Audio Program)

Some TV programs are broadcast with stereo audio or a second audio language (SAP). The Reception: STEREO/MONO/SAP feature lets you select the type of audio you want to record.

To Record Stereo Broadcast TV or SAP

Turn on the TV and tune it to the VCR viewing channel, either 3, 4, or TV's video input.

1. Insert a tape with safety tab in place.
2. If using one of the basic hookups, make sure the VCR indicator appears in the VCR's display panel. If not, press TV•VCR to turn it on.
3. Use SPEED on the remote to select a recording speed. The tape speed indicator appears in the VCR's display panel and on the TV screen.
4. Select the channel or line input to be recorded. The channel number or VIDEO appears on the TV screen.
5. Set the Reception: STEREO/MONO/SAP feature for the type of audio you want to record.
 - A. Press MENU to display the VCR MAIN MENU on the TV screen.
 - B. Press 5 to display the AUDIO menu.
 - C. Press 1 to select the type of audio Reception: STEREO, MONO, or SAP.
 - Set to STEREO for normal recording and to record broadcast stereo TV. The STEREO indicator lights in the VCR's display panel when the station you are tuned to is broadcasting stereo.
 - Set to MONO if the stereo signal is weak and the sound is too "noisy".
 - Set to SAP to record SAP (second audio program) instead of the main audio. The SAP indicator lights in the VCR's display panel when the station you are tuned to is broadcasting SAP. Set the Tape Playback: HI-FI/LINEAR/MIX feature to LINEAR to hear SAP. *Details are on page 17.*
 - D. Repeatedly press 0 to remove the menus from the TV screen.
6. Press REC on the remote or RECORD on the VCR to start recording. REC appears in the VCR's display panel.
7. Press STOP on the remote or STOP•EJECT on the VCR when you are finished.

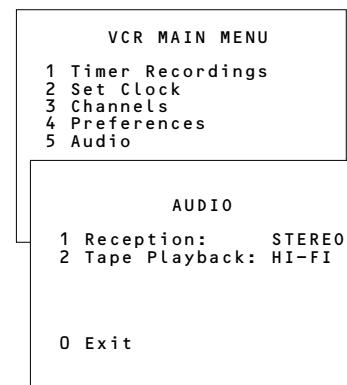

Recording Audio Only

You can record audio only from another audio source connected to the AUDIO IN (L and R) jacks on the back of the VCR. Any video on the tape will be erased when you record audio only.

To Record Audio Only

1. Press the INPUT button to select a line input.
Press INPUT to record from the AUDIO IN jacks on the back of the VCR. VID1 appears in the VCR's display panel.
The VCR will record audio from the audio equipment connected to the AUDIO IN jacks.
2. Use SPEED on the remote to select the recording speed.
The tape speed indicator appears in the VCR's display panel.
3. Make sure the Reception: STEREO/MONO/SAP feature is set to STEREO.
 - A. Press MENU to display the VCR MAIN MENU on the TV screen.
 - B. Press 5 to display the AUDIO menu.
 - C. Press 1 to select Reception: STEREO.
4. Start audio source playing and press REC on remote or RECORD on the VCR to begin recording.
REC appears in the VCR's display panel.
5. Press STOP on the remote or STOP•EJECT on the VCR when you are finished.

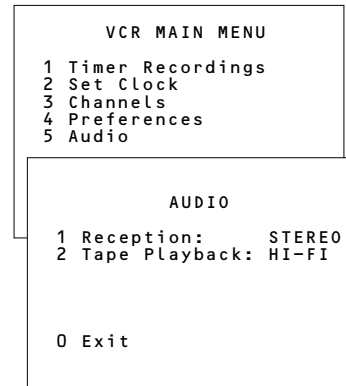

Using Two VCRs for Copying and Editing Tapes

Operating Instructions (Refer to hookup on page 6.)

Use this VCR as the playback VCR and the other as the recording VCR.

Caution: The unauthorized recording of television programs and other materials may infringe the rights of others.

1. Turn on the TV and VCRs.
2. Tune TV to the VCR viewing channel, either 3, 4, or TV's video input.
3. If you have connected your VCR using Option A (page 6), tune recording VCR to channel 3 or 4 — the one selected on the back of the playback VCR.

If you have connected your VCR using Option B (page 6), press INPUT on recording VCR's remote to select the line input (VID1).

4. Insert the tape you want to copy into playback VCR. Insert a blank tape with safety tab in place into recording VCR.
5. Press PLAY, then PAUSE on playback VCR when you reach the point on the tape or program where you want to begin copying. If the tape was not recorded on the playback VCR, streaks may appear and you may need to adjust tracking.
6. Press RECORD, then PAUSE, on recording VCR.
7. Press PAUSE buttons on both VCRs at the same time to begin copying the tape.*
8. Edit out segments that you do not want to copy by pressing PAUSE on recording VCR to stop copying the tape. Then locate the next segment you want to copy on the playback VCR by using FWD, REW, and PLAY. Press PAUSE on the playback VCR. Press PAUSE **at the same time** on both VCRs to resume copying.
9. Press STOP•EJECT on both VCRs when you are finished.

* You may turn off the TV after the recording has started as it does not have to be on to copy a tape.

Location of Controls

Back Panel

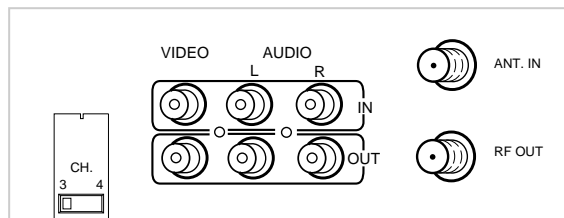

CH3 CH4 Switch

Selects the channel to which you will tune the TV to see the VCR picture if you connect the VCR using one of the basic hookups.

ANT. (Antenna) IN Connector

Receives the signal from an antenna or cable system that is attached to this connector.

RF OUT Connector

Passes signal to TV using the cable supplied.

VIDEO and AUDIO (L and R) IN Jacks

Receives signals from another component, like a VCR or camcorder, when it is connected to these jacks. Use INPUT to select VID1 in the VCR's display panel.

VIDEO and AUDIO (L and R) OUT Jacks

Sends signals from VCR to another component, like a TV monitor or VCR, when it is connected to these jacks.

Display Panel

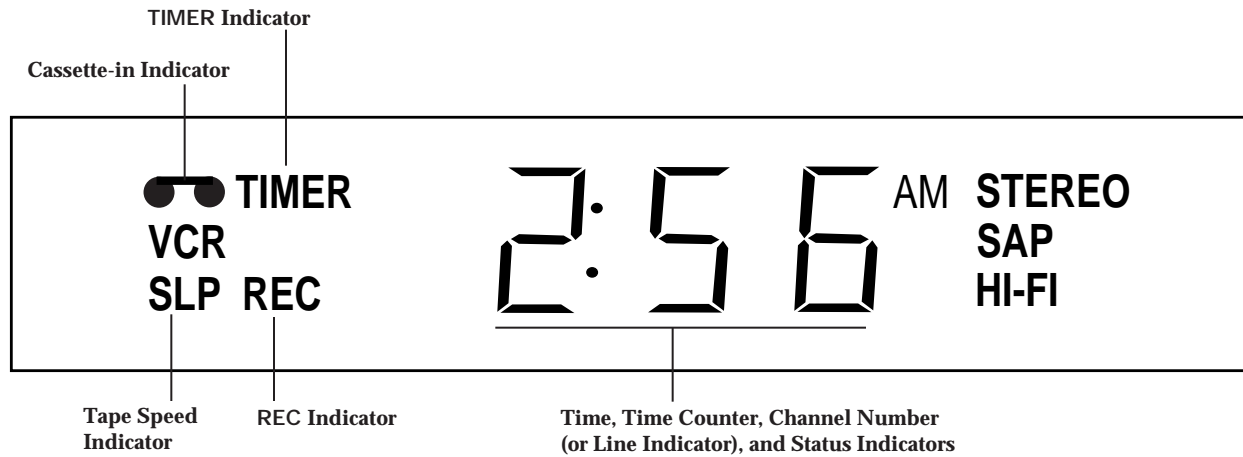
**Cassette-in Indicator ()**

Lights when a tape is in the VCR. Flashes while tape is ejecting.

Channel Number, Line Indicator (VID1), Time, Time Counter, or Status Indicator

The current time, time counter, channel number, or line indicator (VID1) appears here.

Status indicators show what the VCR is doing.

BYE	Turned off
F.FWD	Fast forward
HI	Turned on
PLAY	Playback
PAUS	Frame advance
PAUS	Play pause
REC	Record
REC.P	Record pause
REW	Rewind
SLOW	Slow motion
SRCH+	Forward search
SRCH-	Reverse search
STOP	VCR stopped
T.REC	Timer recording

HI-FI Indicator

Lights during hi-fi playback when Tape Playback: HI-FI/LINEAR/MIX feature is set to HI-FI.

REC Indicator

Lights when the VCR is recording.

SAP Indicator

Lights when the Reception: STEREO/MONO/SAP feature is set to SAP, and the station you are tuned to is broadcasting SAP.

STEREO Indicator

Lights when the Reception: STEREO/MONO/SAP feature is set to STEREO, and the station you are tuned to is broadcasting stereo.

Tape Speed Indicators (SP, LP, or SLP)

Press SPEED to change.

TIMER Indicator

Lights when a timer recording is set.

VCR Indicator (Applies Only to Basic Hookups)

Press TV•VCR to turn on or off.

VCR indicator on: Picture from VCR.

VCR indicator off: Picture from TV channel.

Specifications

Format:	VHS
Record/Playback System:	Video: 4-Head Audio: 2 Hi-Fi record/playback system
Video Signal System:	EIA standard: NTSC color
Antenna:	75-ohm external VHF/UHF combined antenna terminal
Tuner:	USA: 181 channels capability* (125 cable channels) Canada: 178 channels capability* (122 cable channels)
Type:	AutoProgramming frequency synthesis
Power Requirement:	120V AC, 60 Hz
Power Consumption:	19 watts
Dimensions:	3.54 inches high (90 mm) 14.1 inches wide (360 mm) 12.2 inches deep (312 mm)
Weight:	9.46 pounds (4.3 kg)
Storage Temperature Range:	- 22°F (- 30°C) to +149°F (+65°C)
Operating Temperature Range:	+41°F (+5°C) to +104°F (+40°C)

*Check your cable company's compatibility requirements.

Cleaning the VCR

Use a soft cloth or dusting attachment of your vacuum cleaner to dust your VCR. Remove dust from the ventilation holes on the top, back, sides, and bottom of the cabinet.

Plastic surfaces are easily scratched and can be marred by alcohol and various solvents. Avoid excessive use of oil-based furniture polishes since the materials used in the cabinet will accumulate more dust. We recommend using a non-abrasive, anti-static cleaner and polisher.

Trouble Checks

Sometimes problems can be easily solved by checking a few basic things. Check below before you call for help or take your VCR to an Authorized GE VCR Servicenter.

Trouble	Here's what to try:
No power	<ul style="list-style-type: none"> • Plug VCR into an operating outlet. • Check connections.
VCR does not respond to remote	<ul style="list-style-type: none"> • Remove batteries and hold down one or more buttons for several seconds to drain the microprocessor inside the remote to reset it. Reinstall the batteries and try remote again. • Aim remote at VCR with no objects between them. • Change batteries.
No picture when VCR turned on – using a basic hookup	<ul style="list-style-type: none"> • Press TV•VCR to turn VCR indicator on. <i>See page 10.</i> • Check to see if Auto TV/VCR feature is set to OFF. <i>See page 10.</i>
Poor or no picture for normal TV viewing	<ul style="list-style-type: none"> • Press TV•VCR to turn VCR indicator off. • Switch TV to an active channel. • Check antenna connections.
Snowy or no picture during playback	<ul style="list-style-type: none"> • Press TV•VCR to turn VCR indicator on. • Check TV channel selected (3 or 4) to make sure it matches the channel selected with CH3 CH4 switch on back of VCR. • Check TV's fine tuning. • Check video cable connections between VCR and TV monitor. • Set TV monitor to video input channel. • Try another tape. • Some snow/streaks are normal during search, frame advance, slow-motion, or stop-action playback.
Time counter not working	<ul style="list-style-type: none"> • The time counter does not advance during unrecorded portions of tape. When an unrecorded segment of tape is encountered, the time counter will hold its count until recorded material is detected again. • A minus (-) will appear in front of the time if you rewind the tape farther back than a counter reading of 0:00:00.
Will not record or play	<ul style="list-style-type: none"> • No cassette in VCR. • Eject and re-insert cassette. • Broken tape — try another cassette.

Trouble Checks

Trouble	Here's what to try:
Streaks in picture during normal playback	<ul style="list-style-type: none"> • Some snow/streaks are normal during search, frame advance, slow-motion, or stop-action playback.
Will not record	<ul style="list-style-type: none"> • VCR is in pause mode. Press PAUSE. • Safety tab removed from cassette. • Make sure the line indicator (VID1) is turned off in VCR's display panel for normal recording from the VCR's tuner. Press INPUT to turn off the line indicator.
Rewind does not operate	<ul style="list-style-type: none"> • Tape already rewound.
Timer recording not made or wrong program recorded	<ul style="list-style-type: none"> • Cable box was not turned on or was tuned to the wrong channel at time recording was to begin. • Program entered incorrectly (wrong channel or times). • Power interruption. Clock area in display panel will show - -: - -. • Check to see if time and date are correct — including AM/PM. • Check Signal Type: CABLE/ANTENNA feature. <i>See page 8.</i> • Program exceeded tape's length or tape was not rewound beforehand. • VCR was not turned off at the time recording was to start. • No tape in VCR or cassette's safety tab broken off.
Clock shows incorrect time or date	<ul style="list-style-type: none"> • Power interruption. Clock on the front panel will show --:--. • Clock was not set accurately (check AM/PM and date). • Time counter display appears in VCR's display panel. Press DISPLAY on remote.
VCR makes noise when stopped	<ul style="list-style-type: none"> • VCR is removing tape from heads. This is normal. The head cylinder inside the VCR will continue to rotate for a few minutes after you put the VCR in the stop mode.
Will not auto channel search active channels correctly	<ul style="list-style-type: none"> • Check antenna connections. • Check Signal Type: CABLE/ANTENNA feature. <i>See page 8.</i>
Cannot select channels over 69	<ul style="list-style-type: none"> • Cable channels over 69 can only be selected if Signal Type: CABLE/ANTENNA feature is set to CABLE. <i>Details are on page 8.</i>
Cassette with safety tab removed does not start to play automatically	<ul style="list-style-type: none"> • Set Auto Play ON/OFF feature to ON. <i>Details are on page 12.</i>
Displays appear in wrong language	<ul style="list-style-type: none"> • Language feature set incorrectly. <i>Details are on page 9.</i>
Stereo or SAP sound not recorded	<ul style="list-style-type: none"> • Reception: STEREO/MONO/SAP feature must be set to STEREO to record broadcast stereo. <i>See page 23.</i> • Reception: STEREO/MONO/SAP feature must be set to SAP to record SAP. <i>See page 23.</i> • STEREO or SAP indicator not on. Station not broadcasting stereo or SAP.

Limited Warranty

What your warranty covers:

- Any defect in material or workmanship.

For how long after your purchase:

- Ninety days for labor charges.
- One year for parts.
- The warranty period for rental units begins with the first rental or 45 days from date of shipment to the rental firm, whichever comes first.

What we will do:

- Pay any Authorized GE VCR Servicenter the labor charges to repair your VCR.
- Pay any Authorized GE VCR Servicenter for the new or, at our option, refurbished replacement parts required to repair your VCR.

How you get service:

- Take your VCR to any Authorized GE VCR Servicenter. To identify your nearest Authorized GE VCR Servicenter, ask your dealer, look in the Yellow Pages, or call 1-800-447-1700.
- Show the service technician your evidence of purchase date.
- Pick up your VCR when repairs are completed.

What your warranty does not cover:

- Customer instruction. (Your Owner's Manual clearly describes how to install, adjust, and operate your VCR. Any additional information should be obtained from your Dealer.)
- Installation and related adjustments.
- Signal reception problems not caused by your VCR.
- Damage from misuse or neglect.
- Cleaning of video/audio heads.
- Remote control batteries.
- A VCR that has been modified or incorporated into other products or is used for institutional or other commercial purposes.
- A VCR purchased or serviced outside the USA.
- Acts of God, such as but not limited to lightning damage.

Product Registration:

- Please complete and mail the *Product Registration Card* packed with your VCR. It will make it easier to contact you should it ever be necessary. The return of the card is not required for warranty coverage.

How state law relates to this warranty:

- This warranty gives you specific legal rights, and you also may have other rights that vary from state to state.

If you purchased your VCR outside the United States:

- This warranty does not apply. Contact your dealer for warranty information.

Index

- Accessories, Included7
- Add or Remove Channels from
 - Memory9
- ADD/REMOVE CHANNELS Menu9
- Advance, Frame14
- ANT. (Antenna) IN Connector3-6,27
- Antenna Connections2,3
- AUDIO and VIDEO Jacks3-6,17,22,24,27
- AUDIO Menu17,23,24
- Audio Only, Recording24
- Auto Channel Search Feature8
- Auto Play Feature12,13
- Auto TV/VCR Feature3,4,10
- Automatic Tracking14
- Back Panel27
- Basic Recording19
- Batteries, Inserting in Remote7
- Broadcasts Stereo TV, Recording23
- Card, Registrationi
- Cassette-In Indicator12,19,28
- CH3 CH4 Switch3-6,8,27
- CHANNEL Button8,9,10,11,26
- Channel Number Indicator28
- CHANNELS Menu8
- Checking Timer Programs22
- Checks, Trouble30-31
- Choisissez une Langue9
- Choosing a Hookup2
- Cleaning the VCR29
- CLEAR Button9,11,15,16,17,21,22
- Clearing Timer Programs22
- Commercial Scan16
- Connections
 - Antenna System2,3
 - Cable System With Cable Box2,4,5
 - Cable System Without Cable Box2,3
 - Two VCRs For Tape Copying7
 - Contents1
- Copying and Editing Tapes25
- Copying Tape, Connections6
- Date, Set9
- Design Specifications29
- DISPLAY Button9,11,15
- Display Panel28
- Displays, Status15,28
- Editing and Copying Tapes25
- F.ADV (Frame Advance) Button14
- FF and FWD (Fast Forward)
 - Buttons11,13,15,16,25,26
- First-Time Operation7-10
- Frame Advance14
- Front Panel26
- FWD and FF (Fast Forward)
 - Buttons11,13,15,16,25,26
- HI-FI Indicator23,28
- Hookup, Choosing2
- Index Feature16
- INDEX SEARCH Menu16
- INPUT Button11,22,24,27
- LANGUAGE Menu9
- Limited Warranty32
- Line Input, Recording From22
- Manual Tracking14
- MENU Button8,9,10,11,13,17,21
- Number Buttons11
- On-Screen Displays15
- One Touch Recording20
- Operation
 - Audio Only, Recording24
 - Basic Recording19
 - First Time7-10
 - One Touch Recording20
 - Playback12
 - Recording One Channel While Watching Another19
 - Stereo TV Recording23
 - Tape Copying25
- PAUS (Pause) Indicator18
- PAUSE Button11,13,18,25
- Pause for Stop Action13
- Pause, Recording18
- Picture Search13
- Play a Tape12
- PLAY Button11,12,13,14,25
- Playback Sound, Selecting17
- Playback, Slow Motion14
- PLAY•PAUSE Button12,13,14,26
- POWER Button11,26
- PREFERENCES Menu10,13
- PREV CH (Previous Channel) Button11
- Problems, Solving30-31
- Product Registrationi
- REC and RECORD
 - Buttons11,19,23,24,25,26
- REC Indicator19,20,28
- REC.P (Record Pause) Indicator18,28
- Record Audio Only24
- Recording18-25
- Recording Broadcast Stereo TV23
- Recording, Basic19
- Recordings, Types of18
- Registration Cardi
- Remote Sensor26
- Remove or Add Channels from
 - Memory9
- REMOVE/ADD CHANNELS Menu9
- REW (Rewind) Button3,11,12,16,25,26
- RF OUT Connector3-6,27
- Safety Precautionsi
- Safety Tab12
- SAP Indicator23,28
- SEARCH Button11,16
- Select a Language9
- Sensor, Remote26
- Set Clock Feature9
- Set the Time and Date9
- SET TIME AND DATE Menu9
- Setting a Timer Recording21
- Setting Up the VCR7-10
- Signal Type: CABLE/ANTENNA
 - Feature8
- SLOW Button14
- SLOW Indicator14,28
- Slow Motion Playback14
- SLP Speed and Indicator18,28
- Solving Problems30-31
- SP Speed and Indicator18,28
- Specifications29
- SPEED Button11,18,19,20,21,23,24
- Speeds, Recording18
- SRCH Indicators13
- Startup7-10
- Status Displays15
- Status Indicators28
- STEREO/MONO/SAP Feature23,24
- Stop Action Pause13
- STOP Button
 -11,15,16,19,20,21,23,24,25
- Stopping a One Touch Recording20
- Stopping a Timer Recording21
- STOP•EJECT
 - Button12,15,19,20,21,23,24,26
- Tab, Safety12
- Table of Contents1
- Tape Playback: HI-FI/LINEAR/MIX
 - Feature17
- Tape Speed Indicators18,28
- Tape, Playing12
- Time and Date, Set9
- Time Counter15,28
- Time Display9,28
- Time, Set9
- TIMER Indicator21,28
- Timer Recording21
- TIMER RECORDINGS Menu21,22
- TRACKING Buttons11,12,13,14,26
- Trouble Checks30-31
- Turn On TV8
- Turn on VCR8
- TV, Turn On8
- TV•VCR Button10,11,12,19,23,28
- Types of Recordings18
- VCR Controls26-28
- VCR Indicator10,12,19,28
- VCR MAIN MENU
 -8-10,13,17,21,22,23,24
- VCR, Cleaning29
- VCR, Turn On8
- VCRs Memory, Placing Channels In8
- VCRs, Connecting for Tape Copying6
- VID1 Indicator9,11,28
- Warranty, Limited32
- Watch One Channel While
 - Recording Another19
- Zero Search Feature16
- ZERO SEARCH Menu16

For your nearest Authorized Servicenter
call toll-free in the U.S.A.

1-800-447-1700

Canadian Consumers –
Your toll free numbers are:

English: 1-800-522-0338

French: 1-800-522-0445

If your VCR needs service, please contact your dealer
or the nearest Servicenter from the yellow pages.
Please do not send any products to the Indianapolis
address listed in this manual or on the carton. This
will only add delays in service for your product.

 **THOMSON CONSUMER ELECTRONICS**

10330 North Meridian Street
Indianapolis, IN 46290-1024

©1996 Thomson Consumer Electronics, Inc.
Trademark(s)® Registered
Marca(s) Registrada(s)
Printed in Korea
Part Number 96-VG4251-1

Free Manuals Download Website

<http://myh66.com>

<http://usermanuals.us>

<http://www.somanuals.com>

<http://www.4manuals.cc>

<http://www.manual-lib.com>

<http://www.404manual.com>

<http://www.luxmanual.com>

<http://aubethermostatmanual.com>

Golf course search by state

<http://golfingnear.com>

Email search by domain

<http://emailbydomain.com>

Auto manuals search

<http://auto.somanuals.com>

TV manuals search

<http://tv.somanuals.com>