

REAL



VCR OWNER'S MANUAL
MODEL VR663HF



VR663HF

Important Information



CAUTION

**RISK OF ELECTRIC SHOCK
DO NOT OPEN**



TO REDUCE THE RISK OF ELECTRIC SHOCK, DO NOT REMOVE COVER (OR BACK). NO USER SERVICEABLE PARTS INSIDE. REFER SERVICING TO QUALIFIED SERVICE PERSONNEL.



This symbol indicates "dangerous voltage" inside the product that presents a risk of electric shock or personal injury.



This symbol indicates important instructions accompanying the product.

WARNING

To prevent fire or shock hazard, do not expose this VCR to rain or moisture.

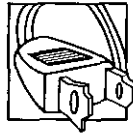

CAUTION: To prevent electric shock, match wide blade of plug to wide slot, fully insert.

MISE EN GARDE: Pour éviter les chocs électriques, introduire la lame la plus large de la fiche dans la borne correspondante de la prise et pousser jusqu'au fond.

Cautions

Do not defeat the safety feature of the plug. The wide blade fits into the wall socket only one way. If you need an extension cord, make sure it matches the plug of the VCR.

Operate VCR only on 120 volts, 60 Hz AC power (normal house power). For safety reasons, make sure any equipment or accessories connected to this product bears the UL listing mark or, if purchased and used in Canada, the CSA certification mark. If in doubt, contact qualified service personnel.

FCC Regulations state that unauthorized changes or modifications to this equipment may void the user's authority to operate it.

Note To Cable TV Installer

This reminder is provided to call your attention to Article 820-40 of the National Electrical Code (Section 54 of the Canadian Electrical Code, Part 1) which provides guidelines for proper grounding and, in particular, specifies that the cable ground shall be connected to the grounding system of the building as close to the point of cable entry as practical.

Product Registration

Please fill out the product registration card and return it immediately. Returning this card allows us to contact you if needed.

Keep your sales receipt to obtain warranty parts and service and for proof of purchase. Attach it here and record the serial and model numbers in case you need them. The numbers are located on the back of the VCR.

Model No. VR663HF

Serial No. _____

Purchase Date: _____

Dealer/Address/Phone: _____

Table of Contents

Important Information

Warnings, Cautions, Note to Cable TV Installer	i
Product Registration	i

Hooking Up the VCR

Choosing a Hookup	2
Antenna or Cable System Without a Cable Box	3
Cable System With Cable Box to Unscramble All Channels	4
Cable System With Cable Box to Unscramble Pay Channels	5
Connecting Two VCRs for Copying Tapes	6
Connecting a Stereo Amplifier/Receiver	7

Setting Up the VCR

Startup	
Check Accessories With VCR	8
Attach Power Cord to VCR	8
Insert Batteries in Remote	8
Turn on TV and VCR	8
Place Channels in VCR's Memory	8
Add or Erase Channels from VCR's Memory	9
Use TV/VCR Button	9
Set the Time and Date	9

Using the Remote Control

Buttons	
Component Buttons	10
VCR Function Buttons	10-11
TV Function Buttons	10-11
Controlling a VCR	12
Controlling a TV	12

Playing a Tape

Operating Instructions	13
Using the Playback Features	
Pause for Stop-Action	14
Slow Motion	14
Picture Search	14
Frame Advance and Commercial Scan	14
Time Search	15
Pro-Tect Plus™ Locking Feature	15
Time Counter with Memory-Stop Feature	16
AUDIO PLAY Feature	17
Auto Tracking and Manual Tracking	17

Recording a Program

Types of Recordings	18
Recording Speeds	18
Recording Pause	18
Basic Recording – Operating Instructions	18
Watch a TV Channel While VCR is Recording	18
Recording Broadcast Stereo TV or SAP	19
Recording While You're Away	
VCR Plus+ Recording	20-22
Timer Recording	23
Checking or Clearing VCR Plus+ or Timer Recordings	23
Express Recording	24
Additional Recording Information	24
Recording Audio Only	25
Using Two VCRs for Copying Tapes	26

References

Specifications	27
Cleaning the VCR	27
Location of Controls	
Front and Back Panel	28
Display Panel	29
Trouble Checks	30-31
Limited Warranty	32
Index	33

Choosing a Hookup

The hookups on pages 3 through 5 are divided into two hookup types: Basic (A) and Advanced (B).

The basic hookup shows the backs of TVs that have only an antenna/cable connection. It is the easier of the two and additional accessories may not be needed.

The advanced hookup shows the VCR hooked up to a monitor/receiver (TV with audio and video jacks) using a signal splitter. This connection may improve the picture quality as well as convenience of operation.

Answer the questions to choose the hookup for your VCR.

1. How do you receive your TV signals?

Choose one answer from below.

- A. Outside antenna – Turn to page 3.
- B. Rabbit ears (set-top) and/or bow tie antenna – Turn to page 3.
- C. Cable System – Go to question 2.

2. What type of Cable-TV system* do you have?

Choose one answer from below.

- A. Cable without a box – Turn to page 3.
- B. Cable box to unscramble all the channels – Turn to page 4.
- C. Cable box to unscramble only pay channels, such as HBO, Showtime, Cinemax, etc. – Turn to page 5.

*You may need to contact your local cable company for assistance.

Optional Hookups

How to hook up two VCRs for copying tapes?

- A. Select a hookup by answering questions 1 and 2 above.
- B. Then modify the connections as shown on page 6.

How to hook up a stereo amplifier/receiver?

- A. Select a hookup by answering questions 1 and 2 above.
- B. Then modify the connections as shown on page 7.

Antenna or Cable System Without a Cable Box

A. Basic hookup.

Use this hookup for a simple connection which requires fewer accessories.

1. Set the CH4 CH3 switch on back of VCR to either channel 3 or 4.
You will tune the TV to this channel and use the TV/VCR button on remote to watch the VCR.
2. Connect as shown.
This connection may require additional accessories not provided.
3. Plug in power cords of VCR and TV.
4. Turn to page 8 for "Setting Up the VCR."

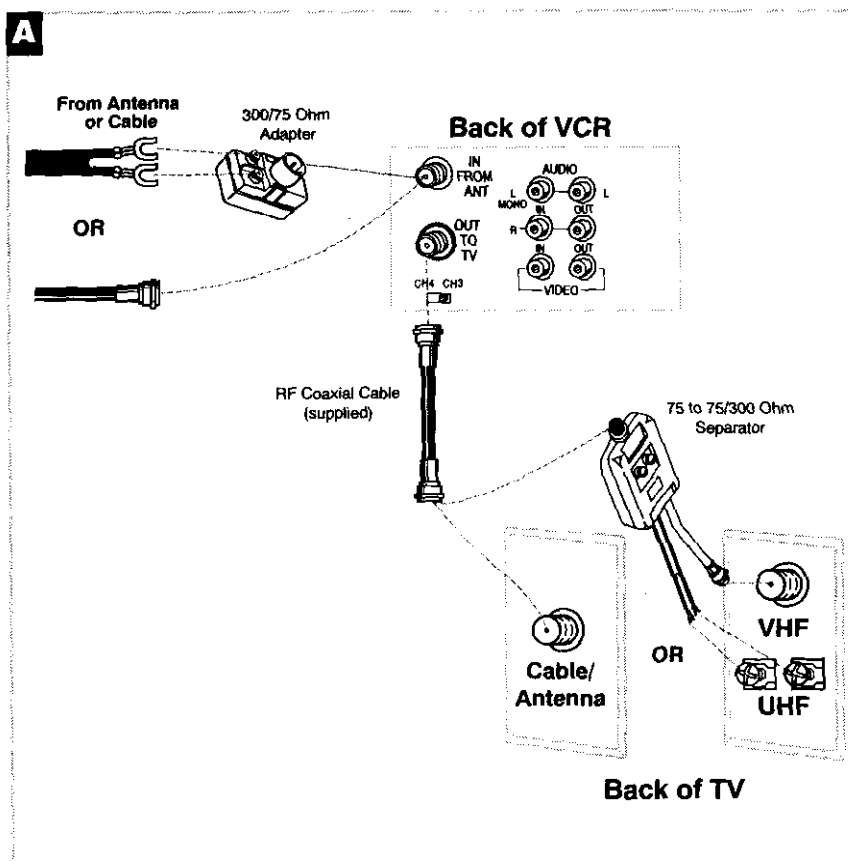

B. Advanced hookup.

Use this hookup for slightly improved picture quality and more convenient operation – use of TV/VCR button not required.

1. Connect as shown.
This connection requires additional accessories not provided.
2. Plug in power cords of VCR and TV.
3. Turn to page 8 for "Setting Up the VCR."
You will tune the TV to its video input to watch the VCR.

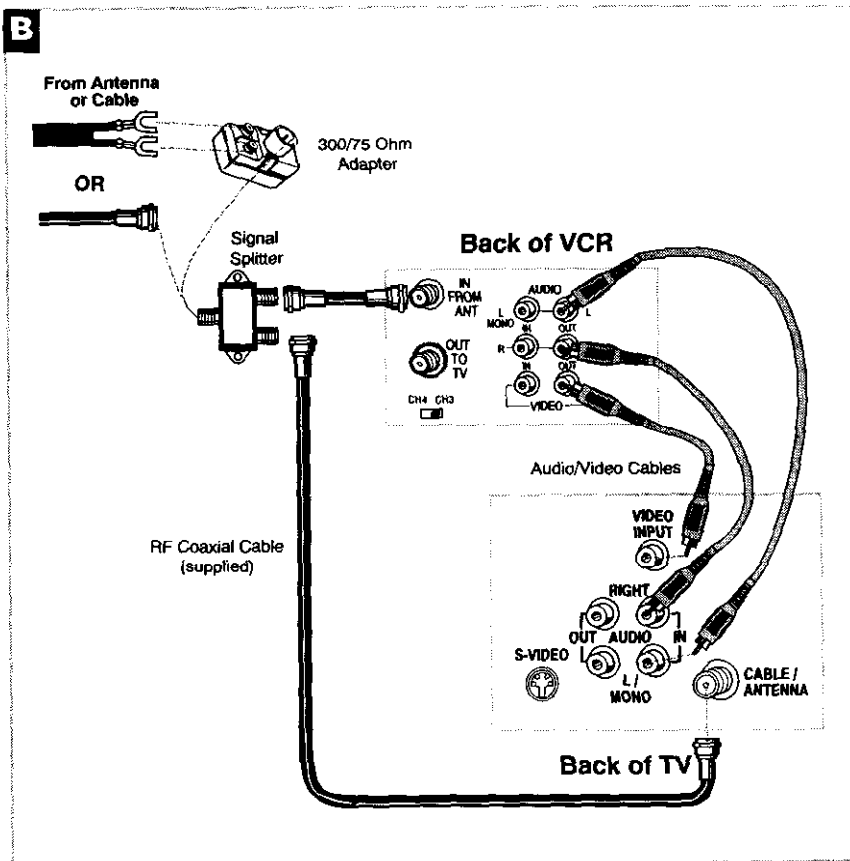

Cable System With Cable Box to Unscramble All Channels

A. Basic hookup.

Use this hookup for a simple connection which requires fewer accessories.

1. Set the CH4 CH3 switch on back of VCR to either channel 3 or 4.

You will tune the TV to this channel and use the TV/VCR button on remote to watch the VCR.

2. Connect as shown.

This connection may require additional accessories not provided.

3. Plug in power cords of VCR, TV, and cable box.

4. Turn to page 8 for "Setting Up the VCR."

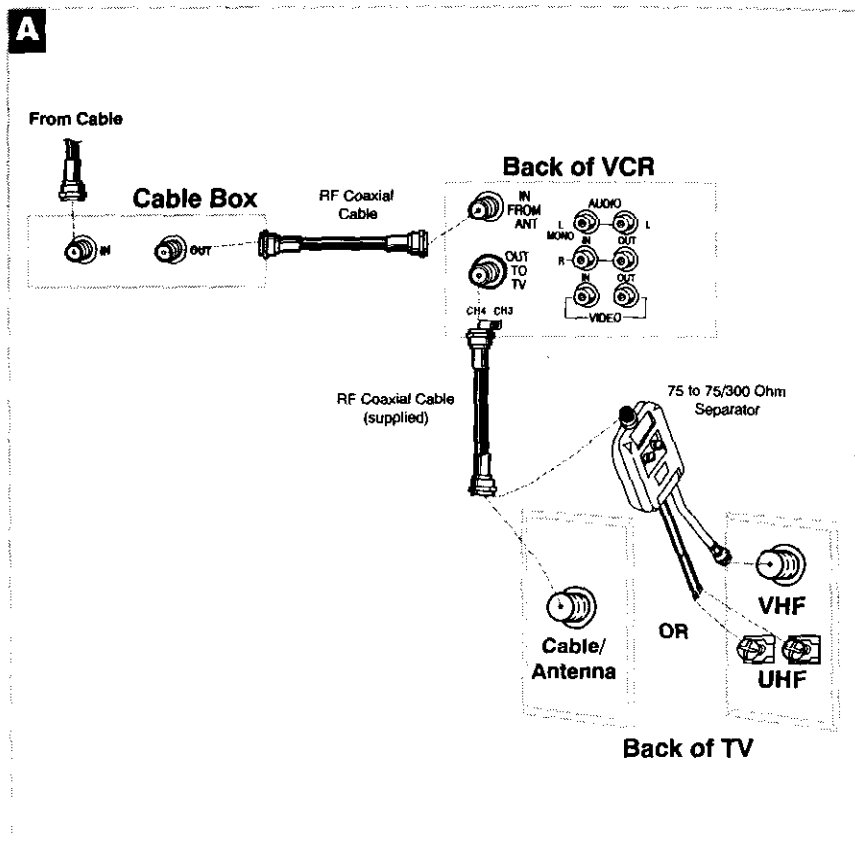

B. Advanced hookup.

Use this hookup for slightly improved picture quality and more convenient operation - use of TV/VCR button not required.

1. Connect as shown.

This connection requires additional accessories not provided

2. Plug in power cords of VCR, TV, and cable box.

3. Turn to page 8 for "Setting Up the VCR."

You will tune the TV to its video input to watch the VCR.

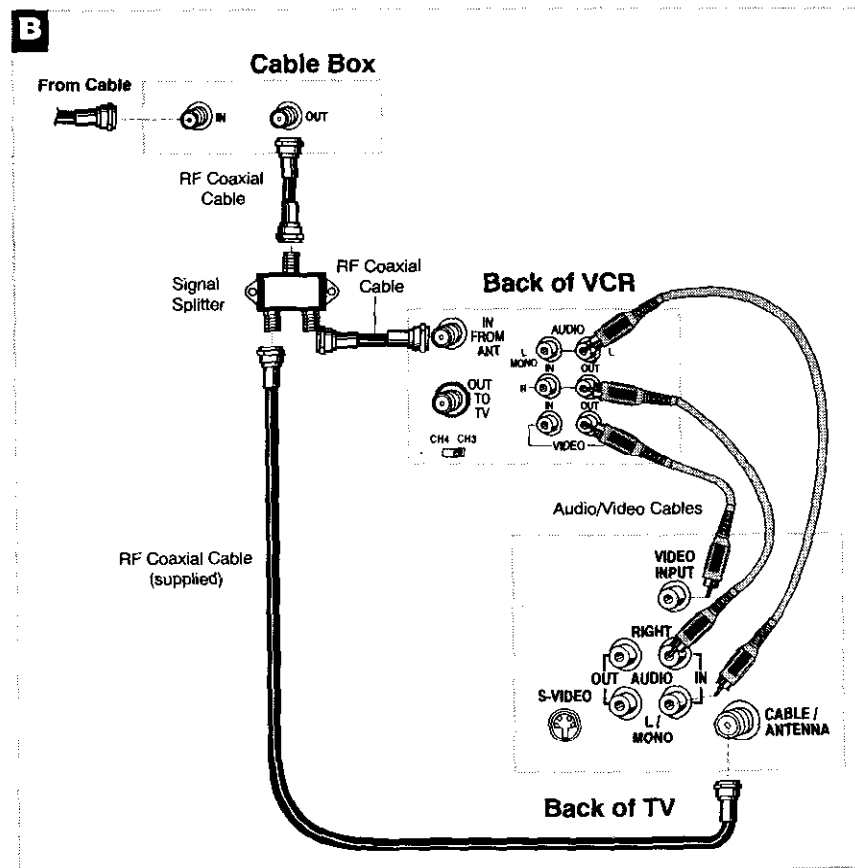

Cable System With Cable Box to Unscramble Pay Channels

(such as HBO, Showtime, Pay-Per-View, etc.)

A. Basic hookup.

Use this hookup for a simple connection which requires fewer accessories.

1. Set the CH4 CH3 switch on back of VCR to either channel 3 or 4.
You will tune the TV to this channel and use the TV/VCR button on remote to watch the VCR.
2. Connect as shown.
This connection may require additional accessories not provided.
3. Plug in power cords of VCR, TV, and cable box.
4. Turn to page 8 for "Setting Up the VCR."

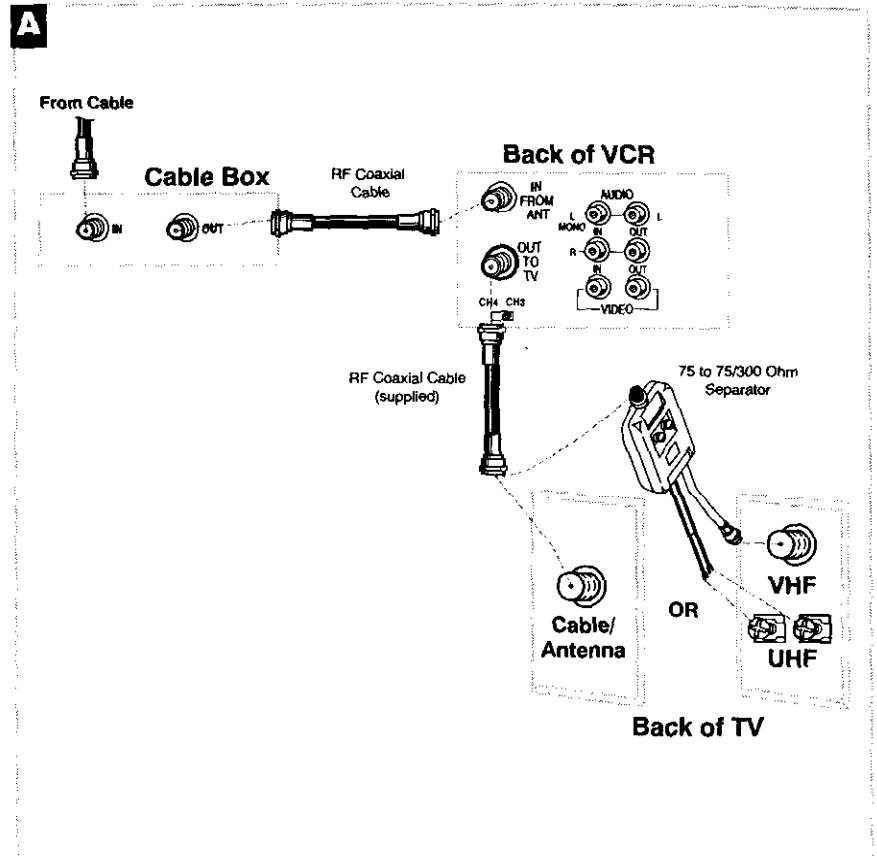

B. Advanced hookup.

Use this hookup for slightly improved picture quality and more convenient operation – use of TV/VCR button not required.

1. Connect as shown.
This connection requires additional accessories not provided.
2. Plug in power cords of VCR, TV, and cable box.
3. Turn to page 8 for "Setting Up the VCR."
You will tune the TV to its video input to watch the VCR. All pay channels are viewed through the VCR.

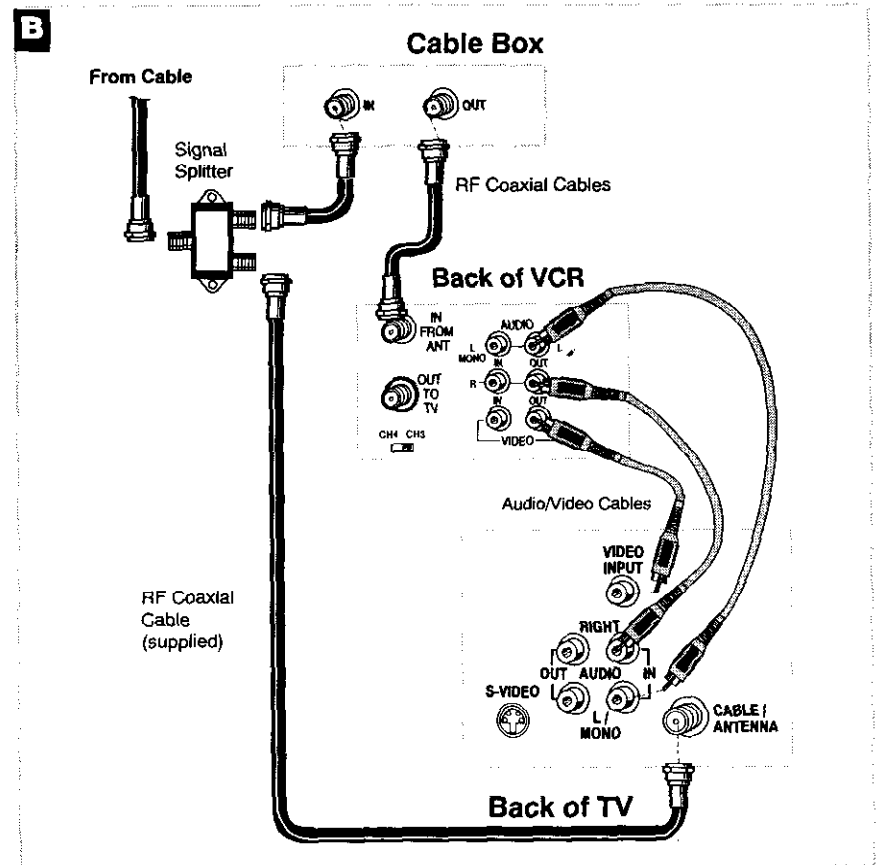

Connecting Two VCRs for Copying Tapes

Option A Hookup.

Use this hookup for a simple connection which requires fewer accessories.

1. Select a hookup from pages 2 through 5 and then modify with this connection.
2. Set the CH4 CH3 switch on the playback VCR to either channel 3 or 4.
You will tune the recording VCR to this channel to receive the signal from the playback VCR.
3. Connect as shown.
This connection may require additional accessories not provided.
4. Plug in power cords of VCRs and TV.
5. Turn to page 8 for "Setting Up the VCR."

A

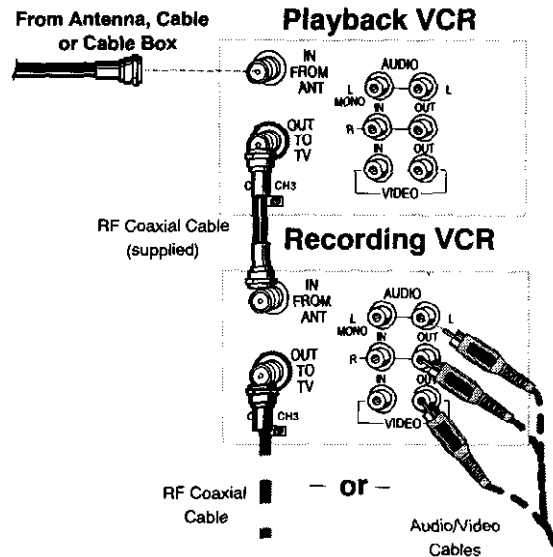

Use the hookup to the TV as previously selected on pages 3, 4, or 5.

Option B Hookup.

Use this hookup for slightly improved copy quality and more convenient operation – use of TV/VCR button not required.

1. Select a hookup from pages 2 through 5 and then modify with this connection.
2. Connect as shown.
This connection requires additional accessories not provided.
3. Plug in power cords of VCRs and TV.
4. Turn to page 8 for "Setting Up the VCR."

You will select the line (audio/video) input on the recording VCR to receive the signal from the playback VCR.

Caution: The unauthorized recording of television programs and other materials may infringe the rights of others.

B

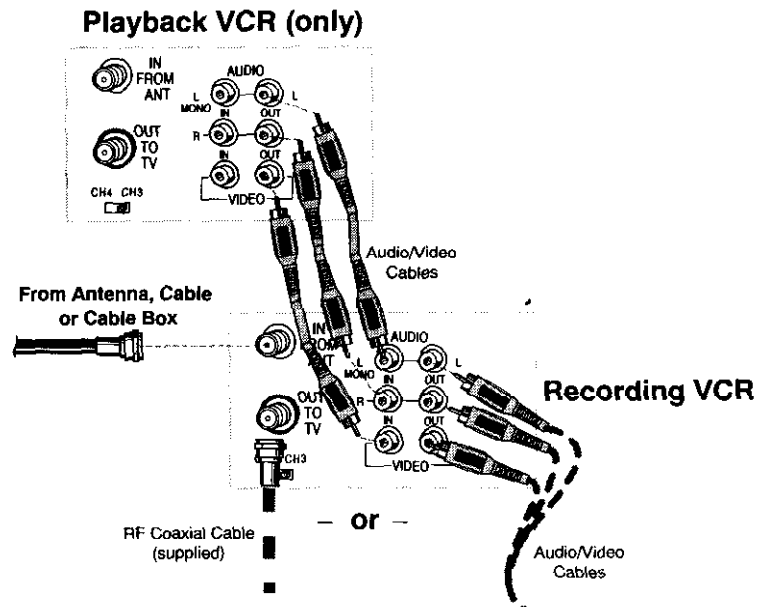

Use the hookup to the TV as previously selected on pages 3, 4, or 5.

Connecting a Stereo Amplifier/Receiver

Record on the VCR from an Amplifier/Receiver

Connect your VCR to a stereo amplifier/receiver to record stereo audio.

1. Select a hookup from pages 2 through 5 and then modify with this connection.
2. Connect as shown.
This connection requires additional accessories not provided.
3. Plug in power cords of amplifier/receiver, VCR, and TV.
4. Turn to page 25 for "Recording Audio Only."
You will select the line input (audio/video) on the VCR to receive the audio signal from the amplifier/receiver.

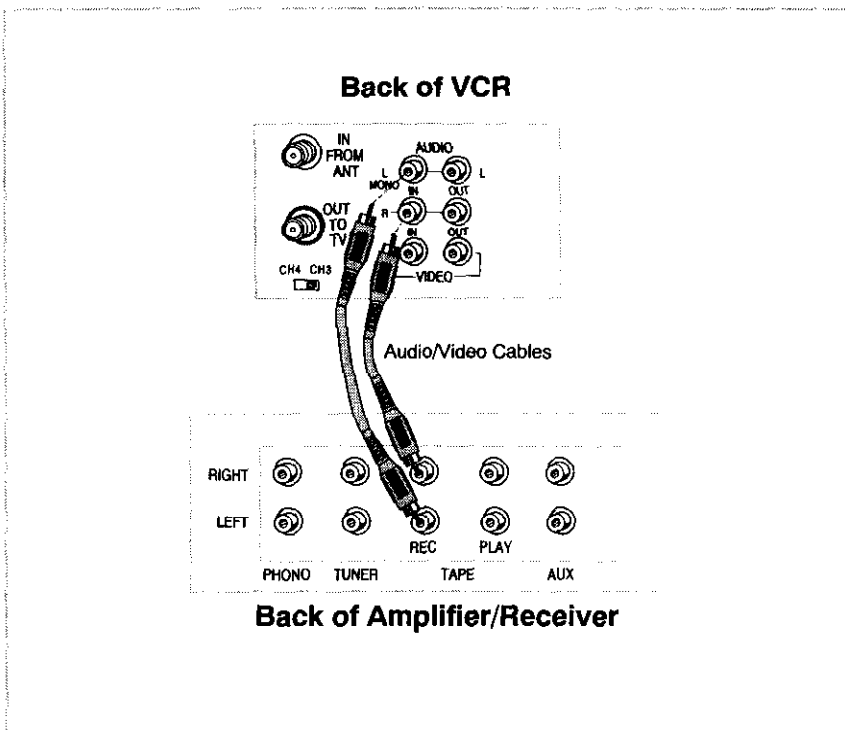

Play Back Stereo Tapes or Receive a Stereo Broadcast Through an Amplifier/Receiver

Connect your VCR to a stereo amplifier/receiver to receive stereo broadcasts or play back stereo tapes.

1. Select a hookup from pages 2 through 5 and then modify with this connection.
2. Connect as shown.
This connection requires additional accessories not provided.
3. Plug in power cords of amplifier/receiver, VCR, and TV.
4. Turn to page 13 for "Playback Operation."

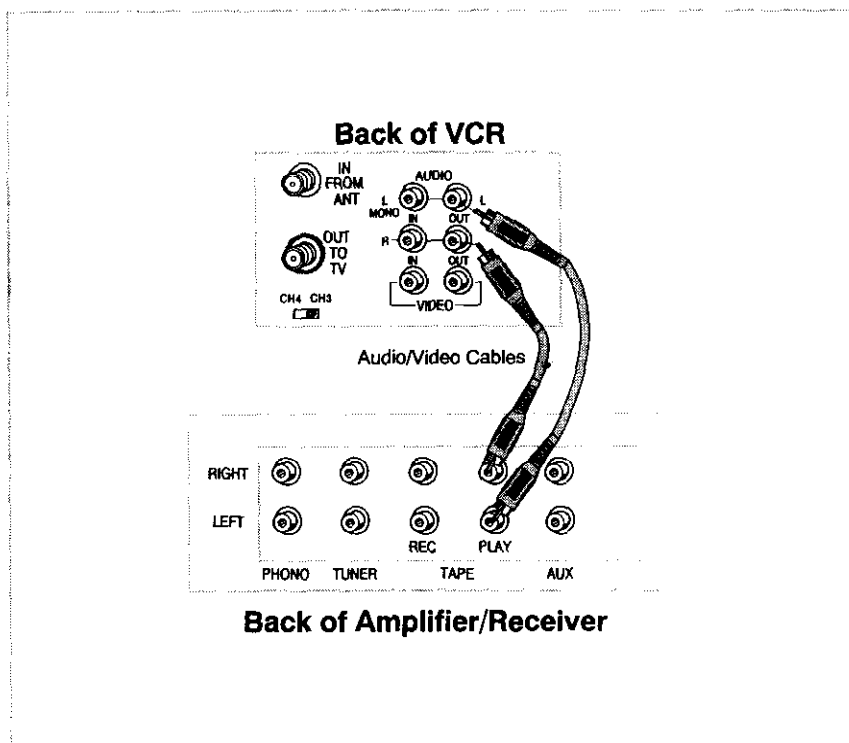

Startup

1. Check accessories with VCR.

Contact your dealer if any items are missing.

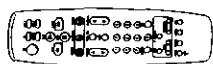

Remote
(Stock No. 218103)

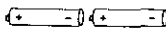

2 "AA" Batteries



Power Cord
(Stock No. 218104)



RF Coaxial Cable
(Stock No. 206085)

2. Attach power cord to back of VCR.

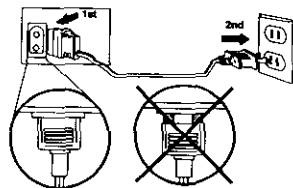

3. Insert batteries in remote.

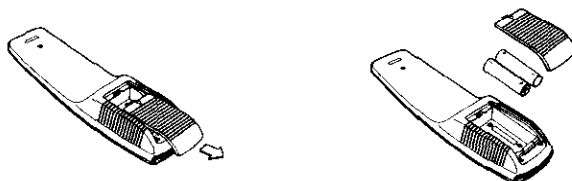

4. Turn on the TV.

- A. Turn on the TV.
- B. If you used one of the basic hookups, tune the TV to the channel selected with the CH4 CH3 switch on back of VCR.
If you used one of the advanced hookups, tune the TV to the TV's video input. (See TV's owner's manual for details.)

5. Turn on the VCR.

- A. Press VCR1 (VCR2) on the remote.

6. Place channels in the VCR's memory (AutoProgram).

Channels 2 through 13 are in the VCR's memory when you first turn it on. Pressing CHANNEL up or down stops on these channels. To get additional channels available on your antenna or cable system, you must AutoProgram the VCR.

- A. Press VCR1 (VCR2) to set remote to control VCR.
- B. Press PROG/VCR+ on the remote to see the VCR MAIN MENU on the TV screen. If the menu does not appear on the TV screen:
 - Make sure TV is tuned to same channel as CH4 CH3 switch on VCR or the TV's video input (refer to TV's manual).
 - Press VCR1 (VCR2), and then press PROG/VCR+.
 - If you use a basic hookup, check VCR indicator in display panel – it should be on. Press TV/VCR to turn it on.
 - Check the connections.
- C. When menu appears, press 5 to select SET UP VCR.
- D. Press 1 to begin AUTOPROGRAM CHANNELS.

Wait until the channel numbers stop changing. This takes about one to two minutes. The TV will then tune to the lowest channel found. Pressing CHANNEL up or down will select only the active channels. The VCR automatically selects ANTENNA or CABLE. If you need to change the setting manually, press 3.

VCR MAIN MENU	
1	VCR PLUS
2	PROGRAM TIMER
3	CABLE/ANT: ANTENNA
4	SET UP CABLE BOX
5	SET UP VCR PLUS
6	ST/MONO/SAP: STEREO
7	AUDIO PLAY: HIFI
8	REMOTE CONT: VCR1
PRESS NUMBER TO SELECT	
PRESS PROGRAM TO END	

Startup

7. Add or erase channels from the VCR's memory.

You may want to add or erase channels if some of the channels are not active, have weak signals, or you do not want to watch them.

- Press VCR1 (VCR2).
- Press PROG/VCR+ on the remote to see the VCR MAIN MENU on the TV screen.
- Press 5 to select SET UP VCR.
- Press 2 to select ADD/ERASE CHANNELS.
- Follow the directions on the screen.
- Add or erase more channels by entering channel numbers or using CHANNEL up or down.

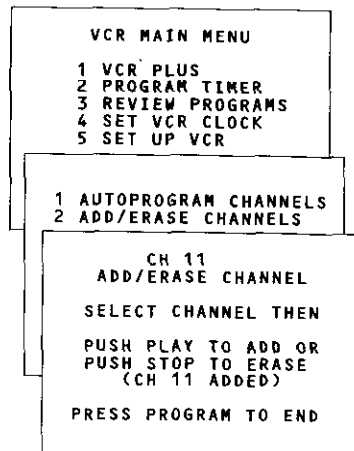

8. Use TV/VCR button.

Skip this step if you used one of the advanced hookups.

When using one of the basic hookups, the TV/VCR button on the remote lets you switch between the picture coming from the VCR or the picture from the TV channel. This button allows you to record a program on the VCR while watching another channel on the TV. *Details are on page 18.*

- Press VCR1 (VCR2) to set remote to control VCR.
- Press TV/VCR to see the picture from the VCR. The VCR indicator lights in the display panel.
- Press CHANNEL up or down to change channels on the VCR. The channel number changes on the TV screen and in the display panel.
- Press TV/VCR to see the TV channels. The VCR indicator does not light in the display panel. Change channels using the TV's remote.
- Return the TV to the VCR viewing channel – CH3 or CH4.
- Press VCR1 (VCR2), then TV/VCR to switch back to the picture from the VCR.

9. Set the time and date.

When you first turn on the VCR, -- : -- appears in the clock area of the VCR's display panel.

VCR Display Panel



- Press PROG/VCR+ on remote to see the VCR MAIN MENU on the TV.
- Press 4 to select SET VCR CLOCK.
- Enter the time and date with the number buttons on the remote.
 - Press 0 before single-digit numbers.
Example: press 0, then 5, then 0, then 7 for a time of 5:07.
 - Press CLEAR on the remote to change incorrect entries.
- Press PROG/VCR+ to start the clock and display the time in the VCR's display panel.

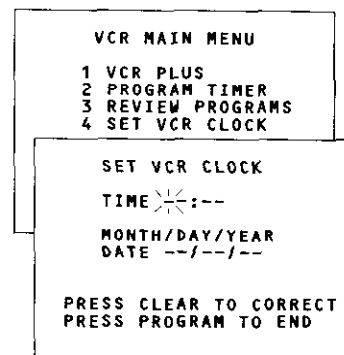

Buttons

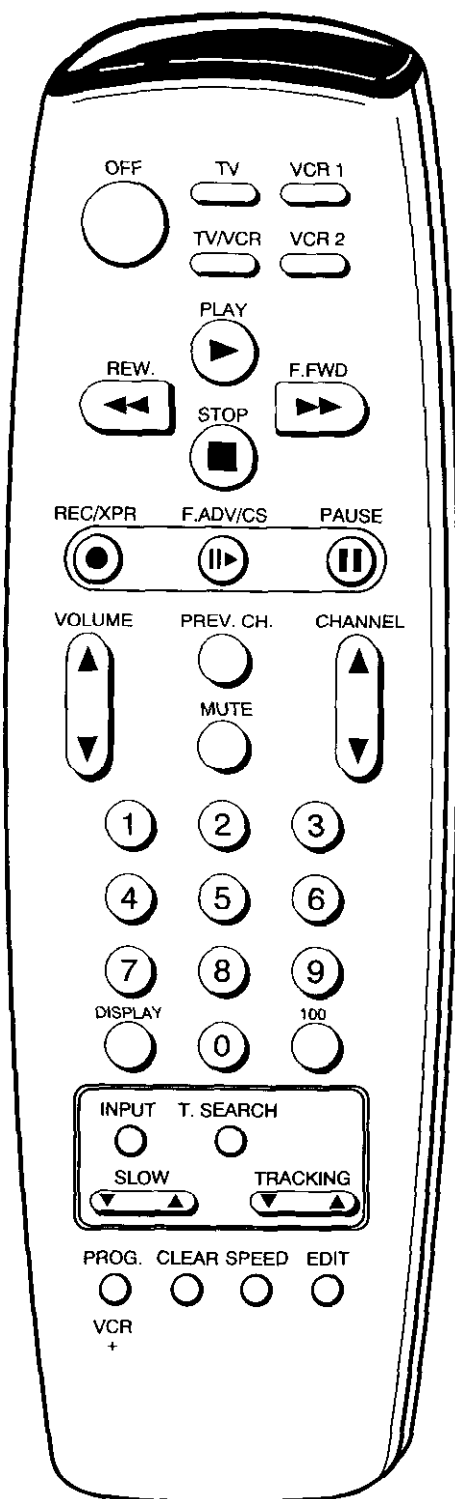

Component Buttons

Press one of the buttons to set the remote to operate that component.

VCR1

Turns on a compatible RCA VCR and sets remote to control the VCR.

VCR2

Turns on a compatible RCA VCR and sets remote to control the VCR when it has been setup. See page 12.

TV

Turns on a compatible RCA TV and sets the remote to control the TV.

Used with OFF to turn another brand of TV on or off when the remote is programmed to control that TV. See page 12.

VCR Function Buttons

Press VCR1 (VCR2) to set remote to control the VCR to use the function buttons.

OFF

Turns off VCR when remote is set to control the VCR.

TV/VCR

Switches the picture signal so that it either comes from the VCR or the TV channel. See page 9.

PLAY

Plays a tape.

REW (Rewind)

Rewinds the tape.

Searches the picture in reverse motion during playback.

F.FWD (Fast Forward)

Fast forwards the tape when the VCR is stopped.

Searches the picture in forward motion during playback.

STOP

Stops the normal functions such as record, playback, rewind, fast forward, and pause of the VCR.

REC/XPR

Starts VCR recording.

Used for express recording (XPR).

F.ADV/CS (Frame Advance/Commercial Scan)

Lets you view one frame with each press of the button when tape is in PAUSE.

Skips short segments of tape during playback.

PAUSE

Pauses action for viewing during playback.

Pauses recording to prevent recording of unwanted scenes.

PREV.CH. (Previous Channel)

Switches between two channels.

Select one channel and then select another. Press PREV.CH. to switch between the two channels.

CHANNEL ▲/▼

Selects next higher or lower channel in the VCR's channel memory.

Buttons

VCR Function Buttons

(continued)

Number Buttons

(0 through 9 & 100)

Select any channel up to 99 by pressing two number buttons.

For a three-digit number, select a channel over 99 by pressing the 100 button and then two number buttons. Or, press and hold 1 until 1 -- appears on the screen. Then press the other two numbers.

DISPLAY

Shows VCR operating displays on the TV screen.

Displays the time counter.

Turns on memory-stop feature.

INPUT

Switches between line input and TV channels (tuner). L appears for line input instead of channel in VCR's display panel.

Line input refers to the signal coming from a component connected to the audio/video input jacks.

T.SEARCH (Time Search)

Displays the time search menu on the TV screen.

SLOW ▲/▼

Used for slow-motion playback.

TRACKING ▲/▼

Lets you manually reduce the streaks that may appear on the picture during play, slow, or pause.

May reduce stereo playback noise.

PROG/VCR+

Displays the VCR MAIN MENU or VCR PLUS menu on TV screen.

CLEAR

Resets time counter to 0:00:00 when it is displayed.

Allows you to correct entries when setting the clock or programming VCR for a VCR Plus+ or timer recording.

SPEED (Tape Speed)

Selects a recording speed (SP, LP, SLP).

EDIT

Signals two properly connected VCRs to begin copying a tape. See page 26.

TV Function Buttons

Press the TV button to set remote to control a compatible TV. Some buttons may not work with the TV.

OFF

Turns off TV when remote is set to control TV.

Used along with the TV button to turn a compatible TV on or off when the remote is programmed to control that TV. See page 12.

VOLUME ▲/▼

Raises and lowers sound.

PREV. CH. (Previous Channel)

Switches between two channels.

Select one channel and then select another. Press PREV CH to switch between the two channels.

CHANNEL ▲/▼

Selects next higher or lower channel in the TV's channel memory.

MUTE

Turns the TV sound on or off.

Number Buttons (0 through 9 and 100)

Select any channel up to 99 by pressing two number buttons.

Select a channel over 99 by pressing the 100 button and then two number buttons for compatible TVs.

DISPLAY

Shows the status displays on the screen.

Removes menus or displays from the screen.

CLEAR

Removes menus or status displays from the screen.

Controlling a VCR

The VCR's remote controls two compatible RCA VCRs with the VCR1 and VCR2 buttons. Most RCA VCRs automatically respond to VCR1 without being programmed. If you own two RCA VCRs, test them to see if VCR1 turns on both VCRs. If it does, then program the REMOTE CONT feature on this VCR to respond to VCR2 if you want to control VCRs separately.

Helpful Hint: Notice the difference between the TV and VCR on-screen displays. This is one way to tell if the remote is set to control the VCR or the TV.

Program the VCR for remote control

Set the REMOTE CONT feature of the VCR to the VCR1 or VCR2 position. The remote then controls the VCR with either the VCR1 or VCR2 button – whichever position you select in the menu.

- Press PROG/VCR+.
- Press 5 to select SET UP VCR.
- Press 8 to select either the VCR1 or VCR2 position.
- Press VCR1 or VCR2 to match the selection you made in step C.

VCR MAIN MENU

- VCR PLUS
- PROGRAM TIMER
- REVIEW PROGRAMS
- SET VCR CLOCK
- SET UP VCR

- AUTOPROGRAM CHANNELS
 - ADD/ERASE CHANNELS
 - CABLE/ANT: ANTENNA
 - SET UP CABLE BOX
 - SET UP VCR PLUS
 - ST/MONO/SAP: STEREO
 - AUDIO PLAY: HIFI
 - REMOTE CONT: VCR1
- PRESS NUMBER TO SELECT
PRESS PROGRAM TO END

Controlling a TV

The VCR's remote is preprogrammed to control the basic functions of a compatible RCA, ProScan, or GE TV. The remote can also be set up to control other manufacturer's brands. To program the remote, use the remote button at the right that corresponds to your brand. Not all models are compatible.

Program the remote for a TV

- Turn on the TV.
- Point the VCR remote at the TV.
- Hold the TV button and press the remote button for your brand. If the TV changes channels, set up is complete.
- Release both buttons.
- Repeat steps B – D with another button if the first one does not work.

Brand	Remote Button	Brand	Remote Button
Admiral	1,6,9	Panasonic	(CH Up)
Akai	6	Philco	6,8
AOC	6	Philips	4
Centuricon	9	Portland	8
Coronado	8	Prism	(CH Up)
Curtis Mathes	1,9	ProScan	1
Daytron	9	Quasar	(CH Up)
Emerson	6,8	RCA	1
Fisher	5	Sampo	9
GE	1	Samsung	8,9
Goldstar	6,8	Scott	9
Hitachi	0,8	Sears	1,5,7
JCPenney	6,9	Sharp	8
KMC	8	Signature 2000	6,9
KTV	6,8	Sony	3
MGA	9	Sylvania	4,9
Magnavox	4,8,9	Teknika	4,8
Marantz	6, (CH Dn)	Toshiba	7
Mitsubishi	6, (CH Dn)	Yorx	9
NEC	6,9	Zenith	2

Operate the TV

After you have set up your remote to control your TV, test the TV buttons to see which ones may operate your TV.

- Point the remote at the TV and press TV.
- If TV does not turn on in step A, press TV and then OFF.
- Use the "TV Function Buttons" as described on page 11.

Operating Instructions

To play a tape

1. Turn on the TV and tune it to channel 3, 4, or TV's video input to see the picture from the VCR.
2. Insert a tape in the VCR.
VCR automatically turns on. The cassette-in  and VCR indicators light. Tape automatically begins playback if the safety tab on the cassette has been removed.

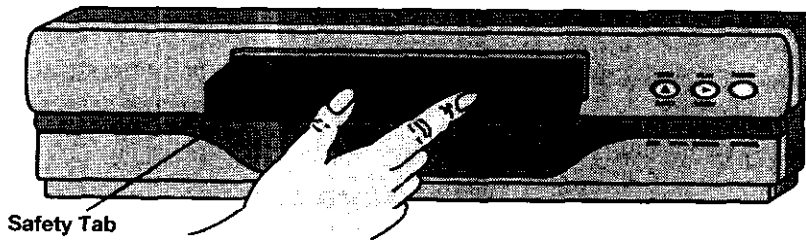

3. If you are playing a stereo tape, set the AUDIO PLAY (HIFI/MIX/LINEAR) feature to HIFI. Press PROG/VCR+, then 5, then 7 to change. The HIFI indicator lights in the VCR's display panel.
4. Press PLAY/PAUSE on the VCR or PLAY on the remote, if necessary.
PLAY appears in the VCR's display panel.
5. If necessary, press TRACKING up or down on the remote to remove any streaks from the picture. *Details are on page 17.*
6. Press STOP/EJECT on the VCR or STOP on the remote.
7. Press REW.
The VCR will automatically rewind the tape if it reaches the end of the tape during playback. While rewinding, you can press POWER on the VCR or OFF on the remote and the VCR will turn off after rewinding.
8. Press STOP/EJECT on the VCR to eject the tape once it is completely rewound.

VCR MAIN MENU	
1	VCR PLUS
2	PROGRAM TIMER
3	REVIEW PROGRAMS
4	SET VCR CLOCK
5	SET UP VCR

1	AUTOPROGRAM CHANNELS
2	ADD/ERASE CHANNELS
3	CABLE/ANT: CABLE
4	SET UP CABLE BOX
5	SET UP VCR PLUS
6	ST/MONO/SAP: STEREO
7	AUDIO PLAY: HIFI
8	REMOTE CONT: VCR1
PRESS NUMBER TO SELECT	
PRESS PROGRAM TO END	

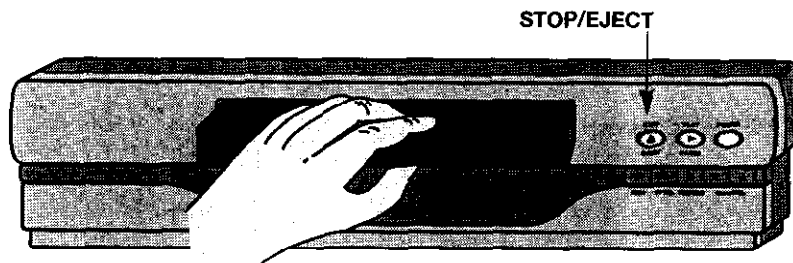

Using the Playback Features

Pause for Stop-Action

This feature stops the tape in action and allows you to examine the details of the scene. Stop-action works best for tapes recorded in the SP and SLP speeds.

1. During playback, press **PLAY/PAUSE** on the VCR or **PAUSE** on the remote to stop the action.
STILL appears in the VCR's display panel.
2. Press **TRACKING** ▲ or ▼ to reduce any jittering of the picture. If streaks or bars appear, press **SLOW** ▲ or ▼ and then **TRACKING** ▲ or ▼.
3. Press **PLAY/PAUSE** on the VCR or **PAUSE** (or **PLAY**) on the remote to return to playback.

The VCR will automatically switch from pause to stop after a few minutes.

Slow Motion

You can view the picture in slow motion during play or play pause. **SLOW** ▲ and ▼ allow you to change the speed. Sound is turned off during slow-motion playback. Slow motion works best in the SP and SLP speeds.

1. Press **SLOW** ▲ to increase the speed or ▼ to decrease the speed.
2. Use **TRACKING** ▲ or ▼ to remove any streaks from the picture.
3. Press **PLAY/PAUSE** on the VCR or **PLAY** on the remote to return to playback.

The VCR will automatically switch from slow-motion playback to stop after a few minutes.

Picture Search

You can search a picture during playback by fast forwarding or rewinding the tape. Sound is turned off during picture search. The picture is best for tapes recorded in the SP or SLP speed.

Fast Forward Search

1. Press **F.FWD** to search forward at a faster-than-normal speed.
2. Press **F.FWD** again, **PLAY/PAUSE** on the VCR, or **PLAY** on the remote to return to playback.

Rewind Search

Use **REW** instead of **F.FWD** for the same steps in "Fast Forward Search."

Frame Advance (F.ADV/CS Button)

Frame Advance lets you view one stop-action frame after another. Frame advance works best for tapes recorded in the SP or SLP speed.

1. Press **PLAY/PAUSE** on the VCR twice or **PAUSE** on the remote to stop the action.
2. Press **F.ADV/CS** each time you want to view a frame of the scene.
Press and hold **F.ADV/CS** to continuously move the tape.
3. Press **PLAY/PAUSE** on the VCR or **PAUSE** (or **PLAY**) on the remote to resume playback.

Commercial Scan (F.ADV/CS Button)

This is useful for skipping commercials or short program segments.

1. Press **F.ADV/CS** once during playback to advance the tape approximately 60 seconds.
2. Press **F.ADV/CS** twice during playback to advance the tape approximately 120 seconds.

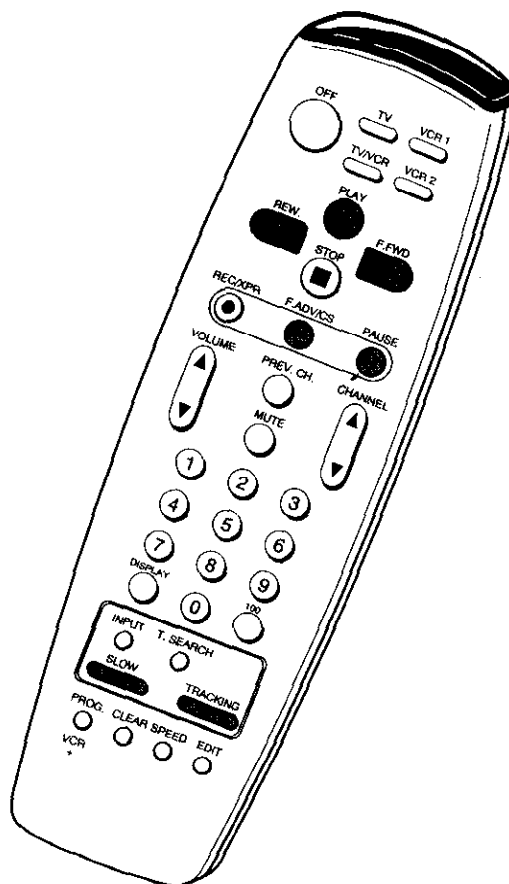

Using the Playback Features

Time Search

The VCR will search forward or backward for a specific amount of recorded tape time (up to nine hours and fifty-nine minutes) and begin playback.

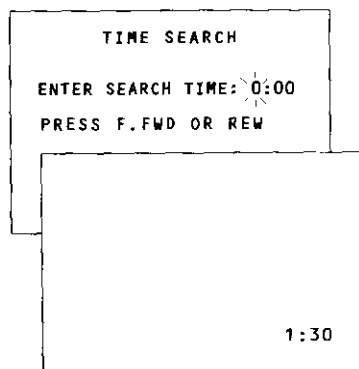

1. Insert a cassette.
2. Place VCR in stop mode.
3. Press T.SEARCH on the remote to display the menu on the TV screen.
4. Press numbers on the remote to enter the hours and minutes you want the VCR to search.
Press CLEAR on the remote to clear an entry.
5. Press F.FWD to search forward. Press REW to search in reverse.
6. The amount of tape time the VCR will search is displayed on the TV screen.
7. Press STOP/EJECT on the VCR or STOP on the remote to stop a search in progress.

Pro-Tect Plus™ Locking Feature

To prevent timer programs from being disturbed, all of the buttons on the VCR and remote can be "locked." Timer recordings will still be made if a cassette with safety tab is inserted.

1. Insert a cassette.
2. Place VCR in stop mode.
3. Press and hold OFF on the remote for five seconds.
LOCK will appear in the VCR's display panel. None of the buttons on the VCR or remote will operate. Also, the cassette door will not open.
4. Press and hold VCR1 (VCR2) on the remote until HELLO appears in the VCR's display panel to unlock Pro-Tect Plus.

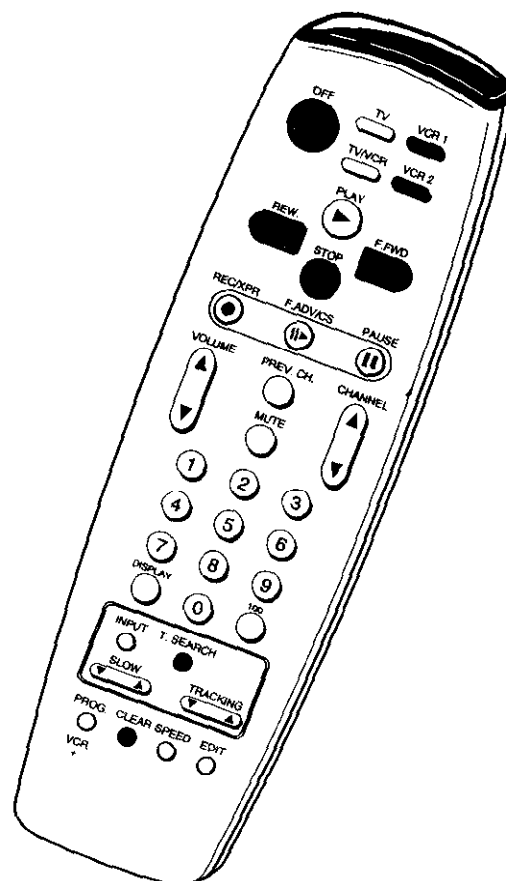

Using the Playback Features

Time Counter

The time counter shows the actual time it takes to record a program or play back a segment of a pre-recorded tape. It helps to quickly locate the end or beginning of the programs you taped. The time counter resets to 0:00:00 whenever the tape is ejected from the VCR.

For example, if a 30-minute program was recorded at the beginning of the tape, you would:

1. Insert the pre-recorded tape.
2. Press DISPLAY twice to display only the time counter on the TV screen.
3. Press F.FWD to fast forward the tape until the time counter reads 0:30:00.
This is the end of the program and you can begin recording at this spot.
4. Press CLEAR to reset the time counter to 0:00:00.
5. Press DISPLAY twice to remove the time counter from the screen.

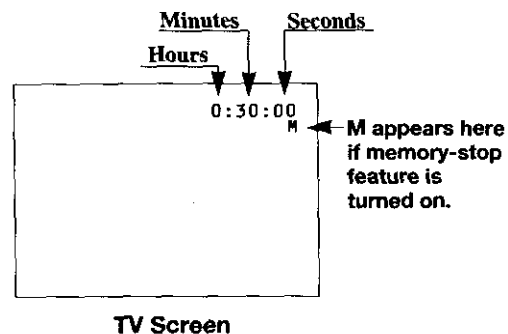

Memory-Stop Feature

The memory-stop feature allows you to quickly return to a counter reading of 0:00:00 M at any spot on the tape. This is especially convenient when you want to watch a segment of the tape several times.

Using the Time Counter's Memory-Stop Feature

1. Insert a pre-recorded tape.
2. Press DISPLAY three times to turn on the memory-stop feature.
An M appears with the time counter to let you know the memory-stop feature is turned on.
3. Press REW, PLAY or F.FWD to move to the spot on the tape where you want to return to quickly.
4. Press CLEAR to reset the time counter to 0:00:00 M at the spot on the tape where you want to return to quickly.
5. Continue playing the tape.
6. Press STOP and then REW or F.FWD when you want to return to the spot you selected on the tape.
The VCR searches for the spot and stops at the counter reading of 0:00:00 M. During fast forwarding, the tape advances to the end of the tape and switches to rewind searching for 0:00:00 M.
7. Press DISPLAY to turn off memory-stop feature.

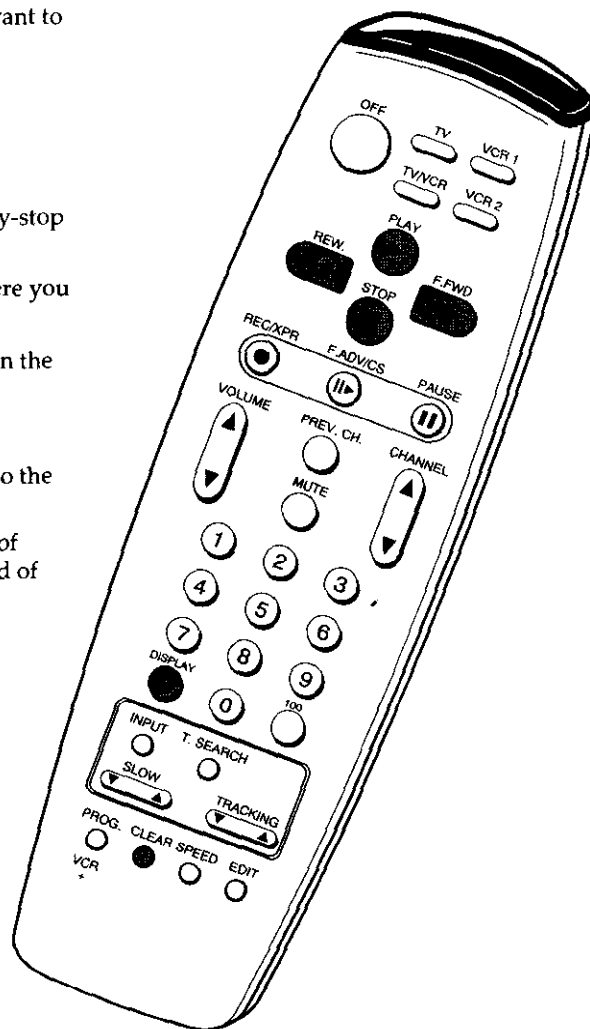

Using the Playback Features

AUDIO PLAY (HIFI/MIX/LINEAR) Feature

The VCR has two separate audio recording systems – VHS Hi-Fi that records on separate left and right stereo channels and standard linear that records monaural sound. The same audio is recorded on both systems. The AUDIO PLAY feature lets you select the audio you play back.

- Select HIFI to play back sound recorded on the Hi-Fi track and for normal use. HIFI appears in the VCR's display panel.
- Select LINEAR to play back the sound recorded on the linear track.
- Select MIX to play back the sound recorded on both the Hi-Fi and linear tracks – sound-on-sound.

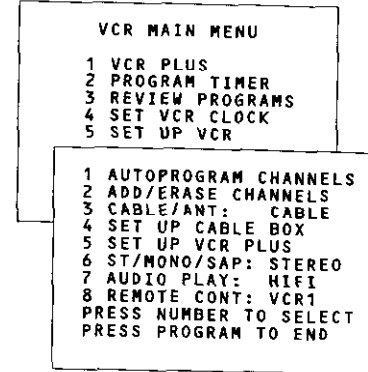

To Select Playback Sound

1. Press PROG/VCR+ to see the VCR MAIN MENU on the TV screen.
2. Press 5 to see the SET UP VCR menu on the TV screen.
3. Press 7 to switch between playback sounds.

Automatic Tracking

The VCR has automatic tracking which adjusts the picture when playing back a tape recorded on another VCR. Automatic tracking is turned on whenever a tape is inserted or the VCR's power is turned on.

Manual Tracking

Occasionally, you may need to manually adjust the tracking on a tape that was recorded on a different VCR or camcorder. The TRACKING buttons on the remote are only used when playing a tape. They have no effect during recording.

When streaks or snow appear during normal or slow-motion playback, press TRACKING up or down for the best possible picture. During stop-action pause, press TRACKING up or down to reduce picture jitter.

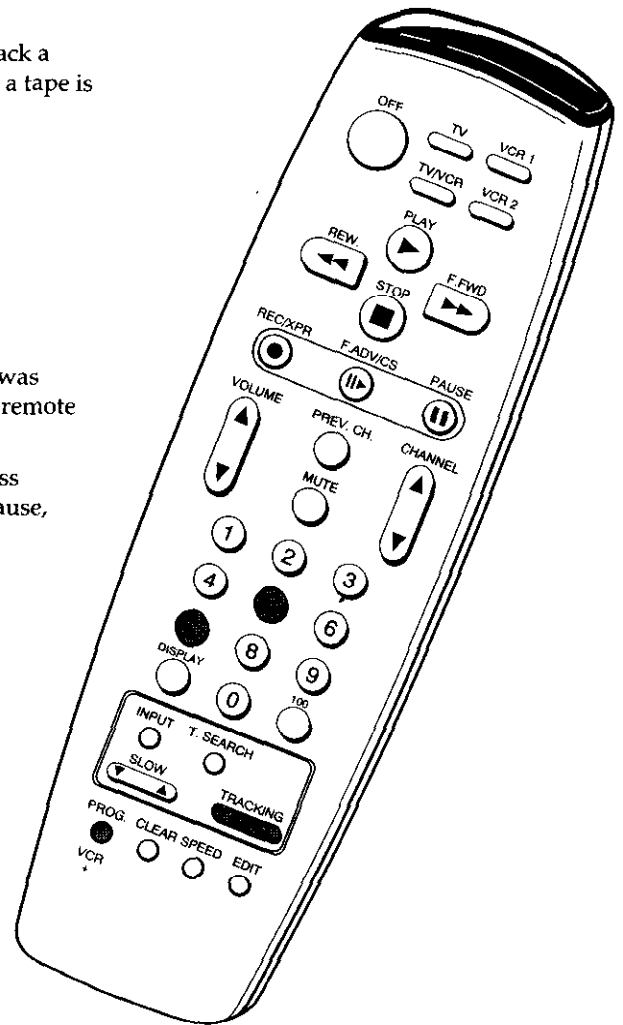

Types of Recordings

Your VCR provides different types of recording. These types are explained in the following sections:

- Basic Recording – Operating Instructions
- Recording While You're Away
- VCR Plus+ Recording
- Timer Recording
- Express Recording
- Using Two VCRs for Copying Tapes

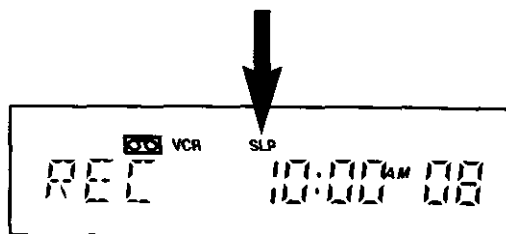

Recording Speeds

SP (Standard Play) gives the best quality recording. That is why most pre-recorded, rental tapes are recorded in SP. Fewer programs can be recorded on the tape. Special effects such as pause, slow motion, picture search, and frame advance work well in this speed.

LP (Long Play) gives twice the recording time of tapes recorded in SP. Special effects in playback are not recommended in LP.

SLP (Super Long Play) gives three times the recording time of tapes recorded in SP. Special effects such as pause, slow motion, picture search, and frame advance work well in this speed.

Recording Pause

This feature allows you to prevent recording short passages of unwanted material.

Press PLAY/PAUSE on the VCR or PAUSE on the remote during recording to stop and start recording.

REC P appears in the VCR's display panel.

The VCR will automatically switch from pause to stop after a few minutes.

Basic Recording – Operating Instructions

To make a recording

Turn on the TV and tune it to the VCR viewing channel, either 3, 4, or TV's video input channel.

1. Insert a tape with safety tab in place.
The cassette-in indicator  lights in the VCR's display panel.
2. Press VCR1 (VCR2) to set remote to control VCR.
3. If using one of the basic hookups, make sure the VCR indicator appears in the VCR's display panel. If not, press TV/VCR on the remote to turn it on.
4. Select a recording speed using SPEED on the remote.
The tape speed indicator appears in the VCR's display panel and on the TV screen.
5. Select the channel to be recorded. (If recording from the audio/video input jacks, press INPUT to select.)
The channel number appears in the VCR's display panel and on the TV screen.
6. Press RECORD on the VCR or REC/XPR on the remote once to begin recording.
REC appears in the VCR's display panel.

Watch a TV channel while VCR is recording a different channel

1. Follow steps 1 – 6 above.
2. If using one of the basic hookups, press TV/VCR to switch to the TV channel.
The VCR indicator will turn off in the VCR's display panel.
3. Press TV to set the remote to control TV functions for a compatible TV.
4. Select the channel you want to watch with the TV's channel buttons.
5. Press STOP/EJECT on VCR or STOP on remote when recording is finished.

Broadcast Stereo TV or SAP (Second Audio Program)



Some TV programs are broadcasts with stereo audio or a second audio program (SAP). Select STEREO to record stereo. Select SAP to record SAP. Select MONO if the stereo signal is not strong enough and too noisy for quality reception.

To record stereo broadcast TV or SAP

VCR Display Panel



Turn on the TV and tune it to the VCR viewing channel, either 3, 4, or TV's video input.

1. Insert a tape with safety tab in place.
The cassette-in indicator  lights in the VCR's display panel.
2. Press VCR1 (VCR2) to set remote to control VCR.
3. If using one of the basic hookups, make sure the VCR indicator appears in the VCR's display panel. If not, press TV/VCR to turn it on.
4. Select recording speed using SPEED on remote.
The tape speed indicator appears in the VCR's display panel and on the TV screen.
5. Select the channel or line input to be recorded.
The channel number appears in the VCR's display panel and on the TV screen.
6. To record stereo TV, the ST/MONO/SAP feature must be set to STEREO. Press PROG/VCR+, then 5, then 6 to change.
The STEREO indicator will then light in the VCR's display panel when the station you are tuned to is broadcasting stereo.
To record SAP, the ST/MONO/SAP feature must be set to SAP. Press PROG/VCR+, then 5, then press 6 to change.
The  indicator will light in the VCR's display panel. SAP will be recorded on the linear track while the normal audio is recorded on the Hi-Fi track.
7. Press RECORD on the VCR or REC/XPR on the remote to begin recording.
REC appears in the VCR's display panel.
8. Press STOP/EJECT on the VCR or STOP on the remote when you are finished. (To playback SAP use the AUDIO PLAY feature. See page 17.)

VCR MAIN MENU

- 1 VCR PLUS
- 2 PROGRAM TIMER
- 3 REVIEW PROGRAMS
- 4 SET VCR CLOCK
- 5 SET UP VCR

- 1 AUTOPROGRAM CHANNELS
 - 2 ADD/ERASE CHANNELS
 - 3 CABLE/ANT: CABLE
 - 4 SET UP CABLE BOX
 - 5 SET UP VCR PLUS
 - 6 ST/MONO/SAP: STEREO
 - 7 AUDIO PLAY: HIFI
 - 8 REMOTE CONT: VCR1
- PRESS NUMBER TO SELECT
PRESS PROGRAM TO END

Recording While You're Away (VCR Plus+ Recording)

VCR Plus+* lets you record a program by entering a PlusCode* number from your TV listing. Because each area has different cable-TV and broadcasting systems, some setup may be required before using VCR Plus+ for the first time.

A. VCR Plus+ Setup for Antenna or Unscrambled Cable Systems (Not Requiring a Cable Box)

A VCR Plus+ channel number is assigned for each broadcast or cable channel. These numbers are listed in most publications that list PlusCode numbers.

1. Prepare a worksheet for the VCR Plus+ channels that are different than the channels you receive them on. Refer to the chart below for standardized VCR Plus+ channel numbers.

Broadcast or Cable-TV Station Name	VCR Plus+ Channel Number	Channel Number You Receive This Station On
HBO	33	See Note 1
ESPN	34	See Note 1
ABC	See Note 2	See Note 1
FOX	See Note 2	See Note 1

Note 1: Check your local or cable listing for the channel number you receive this station on.
Note 2: Check your local listing for the VCR Plus+ or broadcast channel number assigned to this station.

2. Press PROG/VCR+ on the remote to display the VCR MAIN MENU on the TV screen.
3. Press 5 to display SET UP VCR menu.
4. Press 5 to display SET UP VCR PLUS menu.
5. Using your worksheet, press two numbers to enter each channel number you receive on a different channel than the assigned VCR Plus+ channel number.

If a channel in your area has been assigned more than one VCR Plus+ channel number, enter that same channel number next to each VCR Plus+ channel number.

Press CHANNEL up or down to move the VCR+ CH numbers up or down on the menu.

Press CLEAR to erase a number.

6. Press PROG/VCR+ when you are finished.

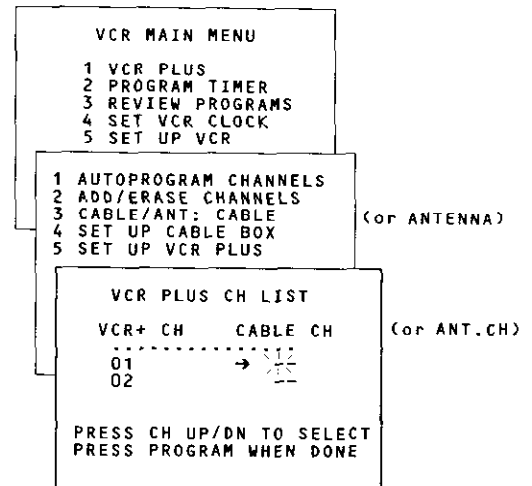

Standardized VCR Plus+ Channel Numbers for Cable-TV			
U.S.A. List	46 Lifetime	Canadian List	65 MeteoMedia/The Weather Network
35 American Movie Classics	58 The Movie Channel	67 Allaroom Pay Television/Superchannel	48 MuchMusic Network
39 Arts & Entertainment	48 Music Television	44 Arts & Entertainment	55 MusiquePlus
57 Black Entertainment Network	49 The Nashville Network	72 Cable News Network-Headline News	52 Nashville Network
54 Bravo	38 Nickelodeon	90 House of Commons	73 Newsworld/CBC
42 Cable News Network	64 The Nostalgia Channel	61 Cable News Network	53 Le Réseau des Sports
45 Cinemax	99 Quality Value Cable	70 Canadian Home Shopping Network	43 The Sports Network
98 Cinemax 2	41 Showtime	56 Canal Famille	64 Super Ecran
37 The Discovery Channel	97 Showtime 2	69 Cathay International Television Inc	98 Super Ecran C
53 The Disney Channel	59 Sports Channel	68 Chinavision Canada Corp	66 Telatino Network Inc
63 Entertainment Television	52 Turner Network Television	60 Country Music Television	46 TV5 Montreal
34 ESPN Sports Network	44 USA Network	63 Family Channel	92 Viewer's Choice 1
47 The Family Channel	62 Video Hits 1	62 First Choice	93 Viewer's Choice 2
33 Home Box Office	93 Viewer's Choice 1	96 First Choice Two	94 Viewer's Choice 3
95 Home Box Office 2	94 Viewer's Choice 2	97 First Choice Three	95 Viewer's Choice 4
96 Home Box Office 3	55 WGN Chicago	91 La Chaîne Française	71 Vision TV: Canada's Faith Network
51 The Learning Channel	43 WTBS Atlanta	51 The Learning Channel	38 Youth TV, Canada Inc
	60 WWOR New York		

*VCR Plus+ and PlusCode are trademarks of Gemstar Development Corporation.

Recording While You're Away (VCR Plus+ Recording)

B. VCR Plus+ Setup for Scrambled Cable System (Requiring a Cable Box)

1. Press PROG/VCR+ on the remote to display the VCR MAIN MENU on the TV screen.
2. Press 5 to display SET UP VCR menu.
3. Press 4 to display SET UP CABLE BOX menu.
4. Press 2 when the CABLE BOX menu appears.
5. Press two numbers on the remote to enter the output channel of your cable box. Press 0 before a single-digit number. (Valid numbers are 2 – 13.)

If you connected your cable box to the VCR using the cable box's AUDIO/VIDEO OUT jacks, press INPUT on the remote to select the VIDEO OUT option.

Press CLEAR to correct an entry.

6. Press PROG/VCR+. A message appears which will time out or press PROG/VCR+ to return to the SET UP VCR menu.

The VCR will now receive all channels from the output channel of your cable box.

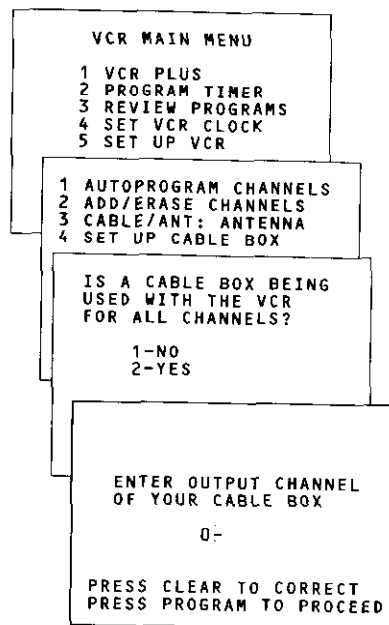

Important: Turn on the cable box and tune it to the channel you want to record before the time the recording is to begin.

continued on next page

Recording While You're Away (VCR Plus+ Recording)

The VCR Plus+ and timer program features let you program the VCR to record up to eight different programs within a one year period. Before using VCR Plus+ to record a program, make sure that:

- Cable box set up has been completed if you use a cable box.
- VCR Plus+ set up has been completed.
- The clock is set correctly.
- A tape with safety tab has been inserted with enough tape to record the programs.
- The remote is set to control the VCR – using VCR1 (VCR2).

Setting a VCR Plus+ Recording

1. Press PROG/VCR+ on the remote to display the VCR MAIN MENU on the TV screen.
2. Press 1 to display the VCR PLUS menu.
3. Press numbers on the remote to enter the PlusCode number for the program you want to record.
Press CLEAR to correct an entry.
4. Press PROG/VCR+ to enter the program.
If the VCR does not recognize the PlusCode number, UNRECOGNIZED NUMBER PLEASE RE-ENTER OR PRESS PROGRAM TO PROCEED appears on the TV screen. Check your number and enter it again.
5. Press 1, 2, or 3 to select type of program.
 - 1 ONE-TIME PROGRAM - single program.
 - 2 DAILY PROGRAM - Monday through Friday.
 - 3 WEEKLY PROGRAM - same program once a week.

A screen appears verifying the channel, time on, time off, and date of the recording.
6. Select a recording speed by pressing SPEED on the remote.
7. Press PROG/VCR+ to enter your program. A reminder appears which will time out or you can press PROG/VCR+ to return to the VCR PLUS menu.
PROGRAMS OVERLAP may appear on the screen if you entered two programs where the times overlap.
See page 23 to clear a program.
8. Repeat steps 2-6 for additional programs or press PROG/VCR+ to remove the menu from the TV screen.
9. **Turn off the VCR** before recording time.
TIMER should appear in the VCR's display panel.
10. If using a cable box, leave it turned on and tuned to the channel you want to record.

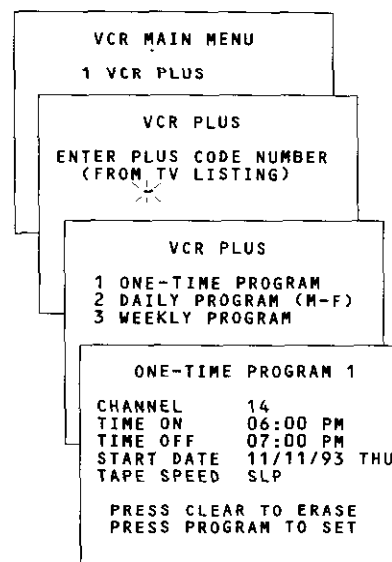

Recording While You're Away (Timer Recording)

The VCR Plus+ and timer program features let you program the VCR to record up to eight different programs within a one year period. Before setting the timer, make sure that:

- Cable box set up has been completed if you use a cable box.
- The clock is set correctly.
- A tape with safety tab has been inserted with enough tape to record the programs.
- The remote is set to control the VCR – using VCR1 (VCR2).

Setting a Timer Recording

1. Press PROG/VCR+ on the remote to display the menu.
If VCR PLUS menu appears, press PROG/VCR+ again.
2. Press 2 to display the PROGRAM TIMER menu.
3. Press 1, 2, or 3 to select type of program.
 - 1 ONE-TIME PROGRAM - single program.
 - 2 DAILY PROGRAM - Monday through Friday.
 - 3 WEEKLY PROGRAM - same program once a week.
4. Press numbers on the remote to enter the channel number (or INPUT to select line input), time to begin, time to turn off, and date of the recording. Just follow the on-screen prompts.
5. Select recording speed using SPEED on the remote.
6. Press PROG/VCR+ to enter your program. A reminder appears which will time out or you can press PROG/VCR+ to return to the VCR MAIN MENU.

PROGRAMS OVERLAP may appear on the screen if you have entered two programs where the times overlap.
7. Repeat steps 1-6 for additional programs.
8. **Turn off the VCR** before recording begins.
TIMER should appear in the VCR's display panel.
9. If using a cable box, turn on the cable box and tune it to the channel you want to record before the time the recording is to begin.

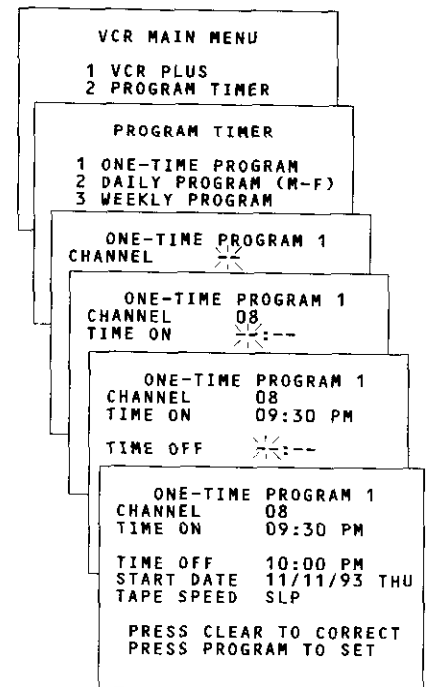

Checking or Clearing VCR Plus+ and Timer Recordings

1. Press PROG/VCR+ on remote to display VCR MAIN MENU on TV screen.
If VCR PLUS menu appears, press PROG/VCR+ again.
2. Press 3 for REVIEW PROGRAMS.
Each entered program is displayed for a few seconds in sequence.
3. Press DISPLAY or 3 to display information at a faster pace.
4. Press CLEAR when the program you want to erase appears on the screen.
5. Press PROG/VCR+ on remote to remove display from the TV screen.

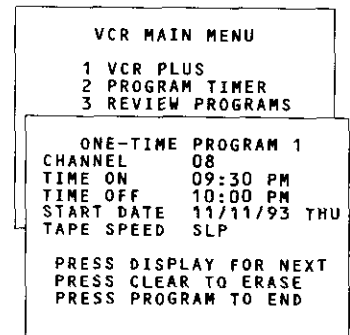

Express Recording (XPR)

Express recording lets you record up to four hours without using the timer program feature. The VCR will turn off automatically at the end of the recording.

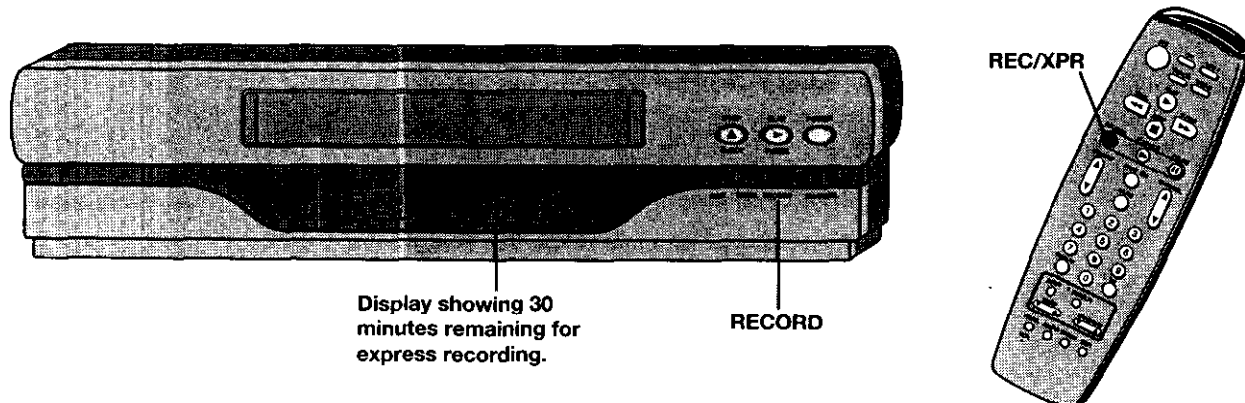

Operating Instructions

1. Turn on the VCR.
2. Insert a tape with safety tab in place.
3. Select the channel you want to record.
4. Select the desired recording speed using SPEED on remote.
5. Press RECORD on the VCR or REC/XPR on the remote to activate express recording.
6. Press RECORD on the VCR or REC/XPR on the remote repeatedly until the amount of recording time for the program is displayed.

Each press of RECORD on the VCR or REC/XPR on the remote increases the time from 30 minutes up to 4 hours.

X — REC and the amount of time the VCR will record appears in the VCR's display panel.

Additional Recording Information

Timer Recording From the VCR's Line Input

The line input refers to the signal coming from the AUDIO and VIDEO IN jacks of the VCR. Recording from the line input is convenient if you have a satellite receiver or similar component attached to these jacks. To timer record from the component connected to the VCR's line input:

Press INPUT on the remote to enter VIDEO IN instead of the channel number on the TV screen during timer programming.

Stopping a Recording in Progress

With the VCR:

Press POWER, then STOP/EJECT, within a few seconds.

With the Remote:

Press VCR1 (VCR2), then STOP, within a few seconds.

Recording Audio Only

You can record audio only from an amplifier/receiver or some other audio source. To play back stereo audio, connect the VCR to a stereo TV or amplifier/receiver. Refer to hookup on page 7.

VCR Display Panel

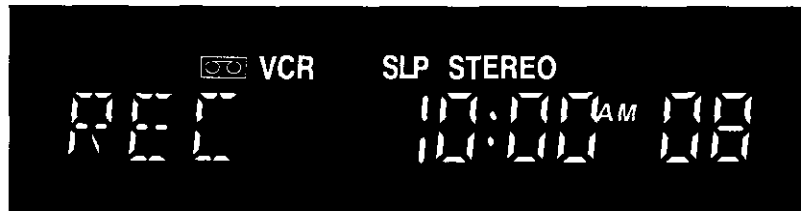

To record audio only

1. Connect the audio equipment to the VCR. Turn it on and prepare it to play.
2. Insert a tape with safety tab in place.
The cassette-in indicator  lights in the VCR's display panel.
3. Press VCR1 (VCR2) to set remote to control VCR.
4. Select recording speed using SPEED on remote.
The tape speed indicator appears in the VCR's display panel and on the TV screen.
5. Press INPUT on remote to select the line input.
6. To record stereo, make sure the ST/MONO/SAP feature is set to STEREO. Press PROG/VCR+, then 5, then 6 to change.
7. Press RECORD on the VCR or REC/XPR on the remote to begin recording.
REC appears in the VCR's display panel.
8. Press STOP/EJECT on the VCR or STOP on the remote when you are finished.

VCR MAIN MENU

- 1 VCR PLUS
- 2 PROGRAM TIMER
- 3 REVIEW PROGRAMS
- 4 SET VCR CLOCK
- 5 SET UP VCR

- 1 AUTOPROGRAM CHANNELS
 - 2 ADD/ERASE CHANNELS
 - 3 CABLE/ANT: CABLE
 - 4 SET UP CABLE BOX
 - 5 SET UP VCR PLUS
 - 6 ST/MONO/SAP: STEREO
 - 7 AUDIO PLAY: HIFI
 - 8 REMOTE CONT: VCR1
- PRESS NUMBER TO SELECT
PRESS PROGRAM TO END

Using Two VCRs for Copying and Editing Tapes

Operating Instructions (Refer to hookup on page 6.)

Use one VCR as the playback VCR and the other as the recording VCR.

Caution: The unauthorized recording of television programs and other materials may infringe the rights of others.

1. Turn on the TV and VCRs.
2. Tune TV to the VCR viewing channel, either 3, 4, or TV's video input.
3. If you have connected your VCR using Option A (page 6), tune recording VCR to channel 3 or 4 – the one selected on the back of the playback VCR. If you have connected your VCR using Option B (page 6), press INPUT on recording VCR's remote to select the line input. L appears in VCR's display panel.
4. Insert the tape you want to copy into playback VCR. Insert a blank tape with safety tab in place into recording VCR.
5. Press PLAY/PAUSE on the playback VCR to play the tape. When you reach the point on the tape or program where you want to begin copying, press PLAY/PAUSE to pause the tape. If streaks appear, you may need to adjust TRACKING.
6. Press RECORD, then PLAY/PAUSE on recording VCR.
7. Press PLAY/PAUSE buttons on both VCRs at the same time to begin copying the tape.*
8. Edit out segments that you do not want to copy by pressing PLAY/PAUSE on recording VCR to stop copying the tape. Then, locate the next segment you want to copy on playback VCR by using F.FWD, REW, and PLAY/PAUSE. Then press PLAY/PAUSE on the playback VCR to pause the tape. Press PLAY/PAUSE at the same time on both VCRs to resume copying.
9. Press STOP/EJECT on both VCRs when you are finished.

* You may turn off the TV after the recording has started as it does not have to be on to copy a tape.

Using Dual Remote with AutoEdit™

Use this VCR as the recording VCR and set it to respond to VCR2 on the remote as described on page 12. Use your other compatible VCR as the playback VCR, which should respond to VCR1.

1. Follow steps 1 – 4 in "Operating Instructions" above.
2. Press VCR2 on remote to control recording VCR. Press REC/XPR, then PAUSE, to put recording VCR in pause mode.
3. Press VCR1 on remote to control playback VCR.
4. Use PLAY, F.FWD, and REW, to locate the point where you want to begin copying. Press PAUSE while VCR is playing to put playback VCR in pause mode.
5. Press EDIT on remote; the VCRs will begin copying.
6. Press EDIT again when you want to stop the tape from copying.
7. Repeat steps 4 – 6 as needed.
8. Press VCR1, STOP, then VCR2, STOP, when you are finished.

Specifications

Format:	VHS
Record/Playback System:	Video: 4-Head Audio: VHS Hi-Fi Stereo record/playback system
Video Signal System:	EIA standard: NTSC color
Antenna:	75-ohm external VHF/UHF combined antenna terminal
Tuner:	USA: 181 channels capability* (125 cable channels) Canada: 178 channels capability* (122 cable channels)
Type:	AutoProgramming frequency synthesis
Power Requirement:	120V AC, 60 Hz
Power Consumption:	22 watts
Dimensions:	3.6 inches high (91 mm) 16.1 inches wide (410 mm) 12.4 inches deep (315 mm)
Weight:	10 pounds (4.55 Kg.)
Storage Temperature Range:	- 22°F to +149°F
Operating Temperature Range:	+41°F to +104°F

*Check your cable company's compatibility requirements.

Cleaning the VCR

Use a soft cloth or dusting attachment of your vacuum cleaner to dust your VCR. Remove dust from the ventilation holes on the top, back, sides, and bottom of the cabinet.

Plastic surfaces are easily scratched and can be marred by alcohol and various solvents. Avoid excessive use of oil-based furniture polishes since the materials used in the cabinet will accumulate more dust. We recommend using a non-abrasive, anti-static cleaner and polisher.

Location of Controls

Front Panel

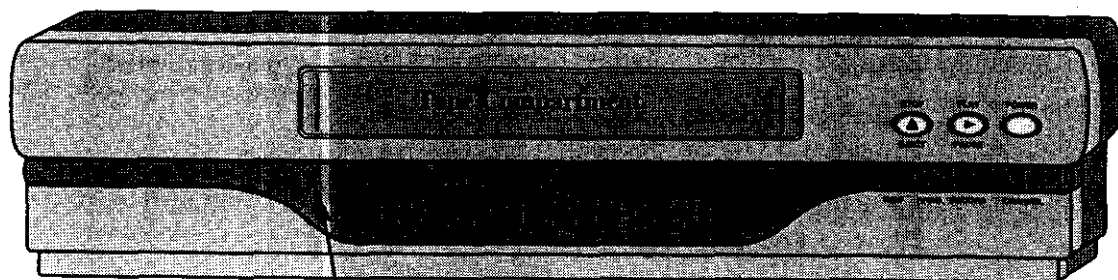

Remote Sensor

Remote Sensor

Receives signals from the remote control. Aim the remote at this sensor with no objects between them.

STOP/EJECT

Stops the normal functions such as record, playback, rewind, fast-forward, or pause of VCR.

Ejects the tape when VCR is stopped.

PLAY/PAUSE

Plays a tape.

During playback, pauses action for viewing.

Pauses recording to prevent recording of unwanted scenes.

POWER

Turns the VCR on or off.

REW (Rewind)

Rewinds the tape.

Searches the picture in reverse during playback.

F.FWD. (Fast-Forward)

Fast-forwards the tape when the VCR is stopped.

Searches the picture forward during playback.

RECORD

Starts VCR recording.

Used for express recording (XPR).

CHANNEL Up and Down

Selects next higher or lower channel in the VCR's channel memory.

Back Panel

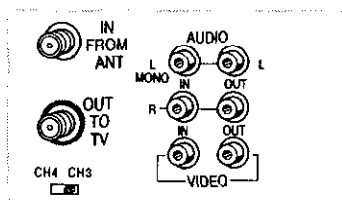

Back Panel of VCR

IN FROM ANTENNA Connector

Receives a signal from an antenna or cable system when attached.

OUT TO TV Connector

Passes signal to TV using the cable supplied.

CH4 CH3 Switch

Selects the channel to which you will tune the TV to see the VCR picture if you connect the VCR using one of the basic hookups.

VIDEO IN and AUDIO (R and L/MONO) IN Jacks

Receives signals from another component, such as a VCR or camcorder, when it is connected to these jacks.

Use the INPUT button on the remote to display L in the VCR's display panel and VIDEO IN on the TV screen.

VIDEO OUT and AUDIO (R and L) OUT Jacks

Sends signals from VCR to another component, such as a monitor TV or another VCR, when it is connected to these jacks.

Location of Controls

Display Panel

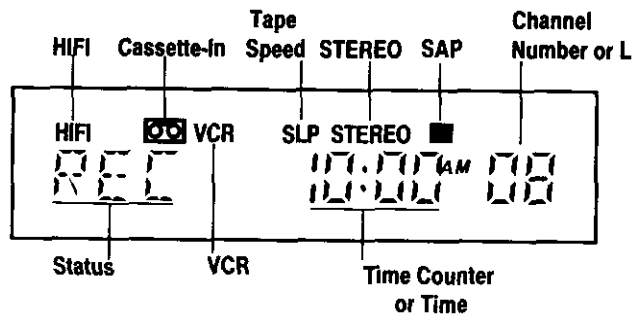

Display Panel of VCR

HIFI Indicator

Lights during HiFi playback when the AUDIO PLAY (HIFI/MIX/LINEAR) feature is set to HIFI or MIX in the SET UP VCR menu.

Cassette-in Indicator ()

Lights when a tape is in the VCR.

Tape Speed Indicators (SP, LP, or SLP)

Press SPEED on remote to change.

STEREO Indicator

The STEREO indicator lights when the station you are tuned to is broadcasting stereo.

The ST/MONO/SAP feature in the SET UP VCR menu must be set to STEREO.

■ (SAP) Indicator

The ■ indicator lights when the ST/MONO/SAP feature in the SET UP VCR menu is set to SAP.

Channel Number or Line Indicator (L)

The channel number or line indicator (L) is displayed.

L lights when you press INPUT on the remote to record from the VIDEO IN and AUDIO IN jacks.

Status Indicators

Show what the VCR is doing.

PLAY	Playback
REC — P	Record-pause
STILL	Play-pause
STILL	Frame advance
SLOW+	Slow motion
REW	Rewind
SRCH —	Reverse search
F — FWD	Fast forward
SRCH+	Forward search
TIMER	Timer programmed
TAPE Flashing	Tape not inserted
REC	Recording
X — REC	Express Recording

VCR Indicator (Applies Only to Basic Hookup)

Lights when using the TV/VCR button.

VCR indicator on: Picture comes from VCR.

VCR indicator off: Picture from TV channel.

Time or Time Counter

Press the DISPLAY button to switch between the current time and time counter.

Trouble Checks

Sometimes problems can be easily solved by checking a few basic things. Check below before you call for help or take your VCR to an Authorized RCA VCR Servicer.

Trouble	Here's what to try:
No power	<ul style="list-style-type: none"> • Make sure VCR is plugged into an operating outlet. • Check connections. • Make sure the VCR's power cord is securely inserted in the back of the VCR.
VCR does not respond to remote	<ul style="list-style-type: none"> • Press VCR1 (VCR2) to set remote to control the VCR. <i>See page 12.</i> • Aim remote at VCR with no objects between them. • Change batteries.
Remote no longer controls an RCA TV	<ul style="list-style-type: none"> • Press TV to set remote to control TV. • Reprogram remote for RCA TV. <i>See page 12.</i>
Remote no longer controls a compatible TV, other than RCA	<ul style="list-style-type: none"> • Press TV to set remote to control a compatible TV. <i>See page 12.</i> • Aim remote at TV with no objects between them. • Reprogram remote after batteries have been changed. <i>See page 12.</i> • Change batteries.
VCR only responds to VCR2 button	<ul style="list-style-type: none"> • Check setting of REMOTE CONT: (VCR1/VCR2) feature. <i>See page 12.</i>
Poor or no picture for normal TV viewing	<ul style="list-style-type: none"> • Press TV/VCR to turn VCR indicator off. • Switch TV to an active channel. • Check antenna connections.
Snowy or no picture during playback	<ul style="list-style-type: none"> • Press TV/VCR to turn VCR indicator on. • Check TV channel selected (3 or 4) to make sure it matches the channel selected with CH3 CH4 switch on back of VCR. • Check TV's fine tuning. • Check video cable connections between VCR and TV monitor. • Set TV monitor to video input channel. • Try another tape. • Some snow/streaks are normal during search, stop-action, frame advance, and slow-motion playback.
Streaks in picture during normal playback	<ul style="list-style-type: none"> • Press one of the TRACKING buttons on the remote to move streaks up or down and out of the picture. • Check tape – it may be worn out or of poor quality.
Time counter not working	<ul style="list-style-type: none"> • The time counter does not advance during unrecorded portions of tape. When an unrecorded segment of tape is encountered, the time counter will hold its count until recorded material is detected again. • A minus (-) will appear in front of the time if you rewind the tape farther back than a counter reading of 0:00:00.
Will not record or play	<ul style="list-style-type: none"> • No cassette in VCR. • Eject and re-insert cassette. • Broken tape – try another cassette. • VCR is in pause mode. Press PLAY/PAUSE on VCR or PAUSE on remote.
Will not record	<ul style="list-style-type: none"> • Safety tab removed from cassette. • Make sure the line indicator (L) is turned off in VCR's display panel for normal recording from the VCR's tuner. Press INPUT on the remote to turn off the line indicator.
Tape stops before complete rewind	<ul style="list-style-type: none"> • Press DISPLAY on remote to turn off memory-stop feature, or press REW again. Tape rewinds to 0:00:00 M when memory stop is turned on.

Trouble Checks

Trouble

Here's what to try:

Rewind does not operate	<ul style="list-style-type: none"> • Tape already rewound.
VCR PLUS display appears on TV instead of VCR MAIN MENU when you press PROG/VCR+ on remote.	<ul style="list-style-type: none"> • After VCR PLUS has been used, the VCR PLUS display will appear automatically when you press PROG/VCR+ on remote. Press PROG/VCR+ again to display the VCR MAIN MENU.
VCR Plus+ or Timer recording not made or wrong program recorded	<ul style="list-style-type: none"> • Code number for VCR Plus+ program entered incorrectly. <i>See page 22.</i> • VCR Plus+ setup not done or done incorrectly. <i>See pages 20-21.</i> • Cable box was not turned on at time recording was to begin or cable box set-up was not done correctly. <i>See page 21.</i> • Program entered incorrectly (wrong channel or times). • Power interruption. Clock area in display panel will show --:--. • Check to see if time and date are correct – including AM/PM. • Program exceeded tape's length or tape was not rewound beforehand. • VCR was not turned off at the time recording was to start. • No tape in VCR, or cassette is ejected if safety tab is broken off. • VCR ejects cassette when the end of the tape is reached during a timer recording.
Clock shows incorrect time or date	<ul style="list-style-type: none"> • Power interruption. Clock on the front panel will show --:--. • Clock was not set accurately (check AM/PM and date). • Time counter display appears in VCR's display panel. Press DISPLAY on remote.
VCR makes noise when stopped	<ul style="list-style-type: none"> • VCR is removing tape from heads. This is normal. The head cylinder inside the VCR will continue to rotate for a few minutes after you put the VCR in the stop mode.
Will not AutoProgram active channels correctly	<ul style="list-style-type: none"> • Check antenna connections. • Check CABLE/ANT: feature to make sure it is properly set. <i>See page 8.</i>
Tape plays back in slow motion	<ul style="list-style-type: none"> • Press PLAY/PAUSE on VCR or PLAY on remote to return to normal playback.
Cannot select cable channels over 69	<ul style="list-style-type: none"> • Cable channels over 69 can only be selected if CABLE/ANT feature is set to CABLE. <i>Details are on page 8.</i>
VCR and remote buttons will not operate VCR	<ul style="list-style-type: none"> • Pro-Tect Plus feature turned on. Press and hold VCR1 (VCR2) button on remote for five seconds to turn Pro-Tect Plus off. HELLO appears in VCR's display panel.
Stereo or SAP sound not recorded	<ul style="list-style-type: none"> • ST/MONO/SAP feature must be set to STEREO to record broadcast stereo. <i>See page 19.</i> • ST/MONO/SAP feature must be set to SAP to record SAP. <i>See page 19.</i> • STEREO indicator not on. Station not broadcasting stereo.
No stereo sound during playback	<ul style="list-style-type: none"> • AUDIO PLAY (HIFI/MIX/LINEAR) feature must be set to HIFI to hear stereo sound during playback. <i>See page 17.</i>
Stereo audio too noisy	<ul style="list-style-type: none"> • Stereo signal is weak. Set ST/MONO/SAP feature to MONO. • Press one of the TRACKING buttons on the remote to minimize the noise.

Limited Warranty

What your warranty covers:

- Any defect in material or workmanship.

For how long after your purchase:

- Ninety days for labor charges.
- One year for parts.

The warranty period for rental units begins with the first rental.

What we will do:

- Pay any Authorized RCA VCR Servicenter the labor charges to repair your VCR.
- Pay any Authorized RCA VCR Servicenter for the new or, at our option, rebuilt replacement parts required to repair your VCR.

How you get service:

- Take your VCR to any Authorized RCA VCR Servicenter. To identify your nearest Authorized RCA VCR Servicenter, ask your dealer, look in the Yellow Pages, or call 1-800-336-1900.
- Show the service technician your evidence of purchase date.
- Pick up your VCR when repairs are completed.

What your warranty does not cover:

- Customer instruction. (Your Owner's Manual clearly describes how to install, adjust, and operate your VCR. Any additional information should be obtained from your Dealer.)
- Installation and related adjustments.
- Signal reception problems not caused by your VCR.
- Damage from misuse or neglect.
- Cleaning of video/audio heads.
- Remote control batteries.
- A VCR that has been modified or incorporated into other products or is used for institutional or other commercial purposes.
- A VCR purchased or serviced outside the USA.

Product Registration:

- Please complete and mail the *Product Registration Card* packed with your VCR. It will make it easier to contact you should it ever be necessary. The return of the card is not required for warranty coverage.

How state law relates to this warranty:

- This warranty gives you specific legal rights, and you also may have other rights that vary from state to state.

If you purchased your VCR in Canada:

- The Canadian warranty applies in place of this warranty.

Index

- Accessories (Packed with).....8
- ADD/ERASE CHANNEL9
- Adding Channels to Channel Memory.....9
- Additional Recording Information.....24
- Antenna Connections.....2-3
- ANTENNA/CABLE Feature.....8
- AUDIO IN and OUT Jacks.....3-7,24,25,28
- Audio Only Recording.....25
- AUDIO PLAY Feature.....13,17
- AUTO PROGRAM Feature.....8
- AutoEdit™.....26
- Automatic Tracking.....17
- AutoProgramming Channel Memory.....8
- Back Panel.....28
- Batteries, Insert in Remote Control.....8
- Buttons.....10,11,28
 - Component.....10
 - VCR Function.....10-11,28
 - TV Function.....10-11
- Cable Box.....4,5,21-23
- Cable-TV Connections.....2,4-5
- Cassette-In Indicator.....13,29
- Cassettes, Inserting and Removing.....13
- CABLE/ANTENNA Feature.....8
- CH3 CH4 Switch.....3-6,8,28
- CHANNEL Buttons.....9,10-11,18,24,28
- Channel Number Display.....29
- Checking Timer Recordings.....23
- Checks and Adjustments.....30-31
- Cleaning the VCR.....27
- CLEAR Button.....9,10-11,15-16,22,23
- Clearing VCR Plus+ & Timer Recordings.....23
- CLOCK SET.....9
- Commercial Scan.....14
- Compatible VCRs.....12,26
- Compatible TVs.....12
- Connections
 - Antenna.....2,3
 - Audio/Video Jacks (Monitor).....2,3-7
 - Cable-TV.....2,4-5
 - Stereo Amplifier/Receiver.....7
 - Two VCRs.....6
- Contents.....1
- Controlling a VCR.....12
- Controlling a TV.....12
- Copying Tapes.....6,26
- Counter, Time.....16
- DISPLAY Button.....10-11,16,23
- EDIT Button.....10-11,26
- Ejecting a Cassette.....13
- Erasing Channels from Channel Memory.....9
- Express Recording.....24
- F.ADV/CS (Frame Advance/Commercial Scan) Button.....10,14
- F.FWD (Fast Forward) Button.....10,14,15,16,26,28
- Frame Advance.....14
- Hookups
 - Amplifier/Receiver.....7
 - Antenna or Cable TV.....2,3
 - Cable Box for All Channels.....2,4
 - Cable Box for Pay Channels.....2,5
 - Two VCRs.....2,6
- IN FROM ANT. Connector.....2,3-6,28
- Indicators.....29
- INPUT Button.....10-11,21,23,24,25,26,28,29
- Inserting Remote Batteries.....8
- Inserting/Removing Cassettes.....13
- L (Line Indicator).....28-29
- Limited Warranty.....32
- Line Input, Timer Recording From.....24
- Location of Controls
 - Remote Control.....10-11
 - VCR Back Panel.....28
 - VCR Display Panel.....29
 - VCR Front Panel.....28
- Locking Feature.....15
- LP Tape Speed.....18,29
- Manual Tracking.....17
- Memory-Stop Feature.....16
- MUTE Button.....10-11
- Number Buttons.....9,10-11,12,16,17,20-23
- OFF Button.....10-12
- Operating Instructions
 - Copying Tapes.....26
 - Express Recording.....24
 - Playing a Tape.....13
 - Recording a Program.....18
 - Recording Broadcast Stereo.....19
 - Recording SAP.....19
 - Recording Audio Only.....25
 - Timer Recording.....23
 - VCR Plus+ Recording.....20-22
- OUT TO TV Connector.....2,3-6,29
- Pay Channels.....2,5
- PAUSE Button.....10,14,18,26
- Pause for Stop-Action.....14
- Picture Search.....14
- Place channels in VCR's memory.....8
- PLAY Button.....10,13,14,15,16
- PLAY/PAUSE Button.....12,13,14,15,16,26,28
- Play Indicator.....13,29
- Playback.....13-17
- Playback, Slow-Motion.....14
- Playing a Tape.....13-17
- POWER Button.....24,28
- Power Cord, Attaching.....8
- PREV CH (Previous Channel) Button.....10-11
- Problem Solving.....30-31
- PROG/VCR+ Button.....8-12,19-23
- PROGRAM REVIEW Feature.....23
- Program the Remote.....12
- Program, Timer.....23
- Pro-Tect Plus™ Feature.....15
- REC Indicator.....18,19,24,25,29
- REC/XPR Button.....10,18,19,24,25,26
- RECORD Button.....18,19,24,25,26,28
- Recording a Program.....18
- Recording Audio Only.....25
- Recording Broadcasts Stereo or SAP.....19
- Recording From Another VCR.....6,26
- Recording One Program While Watching
 - Another.....18
- Recording Speeds.....18
- Recording, Express.....24
- Remote.....8,10-12
- REMOTE (VCR1/VCR2) Feature.....12
- Remote Sensor.....28
- Removing and Inserting Cassettes.....13
- REW (Rewind) Button.....10,13-15,26,28
- RF Coaxial Cable.....2,3-6,8
- Safety Tab.....13
- SAP, Recording.....19
- Search, Picture.....14
- Set the Time and Date.....9
- Set Up, VCR Plus+.....20-21
- Slow-Motion Playback.....14
- Solving Problems.....30-31
- SLOW Buttons.....10-11,14
- SLP Tape Speed.....18
- SP Tape Speed.....18
- Specifications.....27
- SPEED Button.....10-11,18,19,22-26
- Speeds, Recording.....18
- Status Indicators.....29
- Stereo Broadcast, Recording.....19
- STOP Button.....10,13-16,24
- Stop-Action Pause.....14
- STOP/EJECT Button.....13-16,24,28
- Stopping Timer & VCR Plus+ Recordings.....24
- T.SEARCH (Time Search) Button.....10-11,15
- Table of Contents.....1
- Tape Speed Indicators (SP, LP, and SLP).....18,29
- Tapes, Copying.....6,26
- Time Counter.....16
- Time Counter Display.....16,29
- Time
 - Correcting.....9
 - Display.....29
 - Setting.....9
- Time Search Feature.....15
- TIMER PROGRAM
 - Checking & Clearing.....23
 - Timer Recording.....23
 - From VCR's Line Input.....24
 - Indicator.....22,23,24,29
 - Setting.....23
 - Stopping.....24
- Tracking, Automatic & Manual.....17
- TRACKING Buttons.....10-11,13-14,17
- Trouble Checks.....30-31
- Turn on VCR.....8
- TV Button.....10-12
- TV/VCR Button.....3-6,9,10,18
- Types of Recordings
 - Audio Only.....25
 - Basic Recording.....18
 - Broadcasts Stereo or SAP.....19
 - Express Recording.....24
 - Recording While You're Away.....20-23
 - Using Two VCRs for Copying Tapes.....26
- Using Playback Features.....13-17
- VCR, Cleaning.....27
- VCR Indicator.....9,18,29
- VCR PLUS+ PROGRAM
 - VCR Plus+ Recording.....20-22
 - Setting.....22
 - Setup.....20-21
 - Checking & Clearing.....23
 - Stopping.....24
- VCR SET UP Menu.....8,9,12,17,20-21,23,25
- VCR1 Button.....8,10,12,24
- VCR2 Button.....8,10,12,24
- VCR1/VCR2 Feature (VCR SET UP Menu).....12
- VIDEO 1 Indicator.....24
- VIDEO IN and OUT Jacks.....3-7,24,25,28
- VOLUME Buttons.....10-11
- Warranty, Limited.....32
- Watch a TV channel while VCR is recording.....18
- XPR (Express) Recording.....24



For your nearest Authorized Servicenter
call toll-free in the U.S.A.

1-800-336-1900

Canadian Consumers –
Your toll free numbers are:

English: 1-800-522-0338

French: 1-800-522-0445

If you would like a copy of this manual in French, please follow the
instructions below:

Si un livret d'instructions en français n'est pas inclus avec votre appareil, vous
pouvez en obtenir un (indiquer le numéro de modèle, votre nom, et votre
adresse) en vous adressant à:

Thomson Consumer Electronics
Attention: Canadian Operations
P.O. Box 0944
Indianapolis, IN 46206-0944

If your VCR needs service, please contact your
dealer or the nearest Servicenter from the yellow
pages. Please do not send any products to the
Indianapolis address listed in this manual or on
the carton. This will only add delays in service
for your product.

Thomson Consumer Electronics
600 N Sherman Dr, PO Box 1976
Indianapolis, IN 46206

©1993 Thomson Consumer Electronics, Inc.
Trademark(s)® Registered
Marca(s) Registrada(s)
Printed in Singapore
Part Number 93-VR663HF-1



20161870

Free Manuals Download Website

<http://myh66.com>

<http://usermanuals.us>

<http://www.somanuals.com>

<http://www.4manuals.cc>

<http://www.manual-lib.com>

<http://www.404manual.com>

<http://www.luxmanual.com>

<http://aubethermostatmanual.com>

Golf course search by state

<http://golfingnear.com>

Email search by domain

<http://emailbydomain.com>

Auto manuals search

<http://auto.somanuals.com>

TV manuals search

<http://tv.somanuals.com>