

RCA

VCR

User's Guide

Changing Entertainment. Again.



VR648HF/VR712HF

Important Information

WARNING

To reduce the risk of fire or electric shock, do not expose this product to rain or moisture.

CAUTION

RISK OF ELECTRIC SHOCK. DO NOT OPEN.

Caution: To reduce the risk of electric shock, do not remove cover (or back). No user serviceable parts inside. Refer servicing to qualified service personnel.



This symbol indicates "dangerous voltage" inside the product that presents a risk of electric shock or personal injury.



This symbol indicates important instructions accompanying the product.

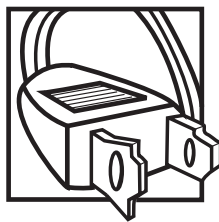

Caution: To prevent electric shock, match wide blade of plug to wide slot, fully insert.

Attention: Pour éviter les chocs électriques, introduire la lame la plus large de la fiche dans la borne correspondante de la prise et pousser jusqu'au fond.

Refer to the identification/rating label located on the back panel of your product for its proper operating voltage.

FCC Regulations state that unauthorized changes or modifications to this equipment may void the user's authority to operate it.

Cable TV Installer: This reminder is provided to call your attention to Article 820-40 of the National Electrical Code (Section 54 of the Canadian Electrical Code, Part 1) which provides guidelines for proper grounding and, in particular, specifies that the cable ground shall be connected to the grounding system of the building as close to the point of cable entry as practical.

Product Registration

Please fill out the product registration card and return it immediately. Returning the card allows us to contact you if needed.

Product Information

Keep your sales receipt to obtain warranty parts and service and for proof of purchase. Attach it here and record the serial and model numbers in case you need them. The numbers are located on the back of the product.

Model No. _____

Serial No. _____

Purchase Date: _____

Dealer/Address/Phone: _____

COMMERCIAL *ADVANCE* and *MOVIE ADVANCE* are registered trademarks of SRT, Inc.; a Jerry Iggulden invention licensed in association with Arthur D. Little Enterprises.

Chapter 1: Connections & Setup

Things to Consider Before Connecting Components	3
Cables Needed to Connect Components to Your VCR	4
Choose Your Connection	4
TV + VCR	5
TV + VCR + Satellite Receiver	6
TV + VCR + Cable Box	7
Put Batteries in the Remote Control	8
Turn on the TV and VCR	8
Using the Remote Control to Choose On-screen Menu Items	8
Complete the on-screen setup guide	8
VCR Basics	10
Playing a tape	10
Automatic Rewind	10
Tape Eject	10
Basic Recording	10
Check the Safety Tab	10

Chapter 2: Remote Control

The Buttons on the Remote Control	11
Using the INPUT Button	12
Programming the Remote to Operate Other Components	13
Find Out If You Need to Program the Remote	13
Programming the Remote	13
Using Automatic Code Search	13
Using Direct Entry	14
How to Use the Remote After You've Programmed It	14
Code List	15

Chapter 3: VCR Features

Recording Features	17
Express Recording (XPR)	17
Timer Recording	18
Stopping a Timer Recording	18
Reviewing and Clearing Programs	18
Index Search	19
Zero Search	19
Pro-Tect Plus™ Locking Feature	19
Time Counter	20
Info Display	20
COMMERCIAL ADVANCE	21
COMMERCIAL ADVANCE Marking	21
COMMERCIAL ADVANCE Playback	22
COMMERCIAL ADVANCE Display	23
MOVIE ADVANCE	23
To Override the Show Previews Mode:	23

Table of Contents

Chapter 4: On-Screen Menus

Explanation of the Menu System	27
Timer Recordings	27
Time	27
Channels	27
Auto Channel Search	27
Add/Remove Channels	28
Signal Type	28
Cable Box Setup	28
VCR Output Channel	28
Setup	29
Preferences	29
Remote Control	29
Auto Play	29
Auto TV/VCR	29
EnergySaver	29
Front Panel	29
Tape Speed	30
Recording Speeds	30
Set Auto Repeat	30
COMMERCIAL ADVANCE	30
Audio	30
Reception	30
Tape Playback	30
Language	30

Chapter 5: Additional Information

Troubleshooting	31
Questions and Answers About COMMERCIAL ADVANCE	34
Display Panel	35
Glossary	35
Limited Warranty	36
How to Find Your TV's Video Input Channel	38
Index	41

Things to Consider Before Connecting Components

Protect Components From Power Surges

- Connect all components before plugging any power cords into the wall outlet.
- Always turn off the TV and other components before you connect or disconnect any cables.

Position Cables to Avoid Audio Hum or Interference

- Insert all cable plugs firmly into their jacks.
- Place any Audio/Video (A/V) cables to the side(s) of the TV's back panel instead of straight down the back after connecting components.
- Try not to coil any twin-lead cables and keep them away from all A/V cables as much as possible.
- Make sure all antennas and cables are properly grounded. Refer to the *Safety Tips* sheet packed with your unit for detailed information.

Protect Components From Overheating



- Never block ventilation slots in any component. Arrange the components so that air can circulate freely.
- Do not stack components.
- Allow adequate ventilation when placing components in a stand.
- Place an amplifier or satellite receiver on the top shelf of a stand so heated air rising from it will not flow around other components.

Chapter 1: Connections & Setup

Choose Your Connection

There are several ways to hook up your VCR, depending on the components connected. Please use the following chart to determine which connection is best for you and proceed to the appropriate page.

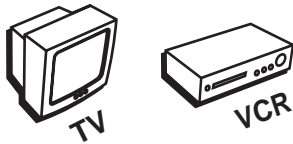
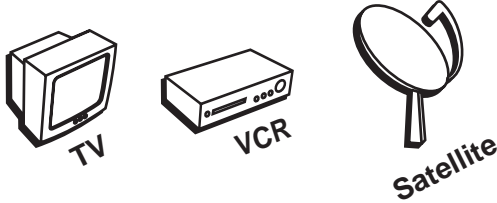
Note: If you prefer, we can provide you with the name of an Authorized Service Representative who will visit your home for a fee to install your electronic entertainment system and to instruct you in its operation. For details about this service, call 1-888-206-3359.

Components	Connection Title	Go To
 TV VCR	TV + VCR	page 5
 TV VCR Satellite	TV + VCR + Satellite Receiver	page 6
 TV VCR Cable Box	TV + VCR + Cable Box	page 7

Cables Needed to Connect Components to Your VCR

The pictures below show the cables needed for the connections represented in this book.

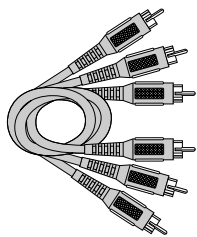

Audio/Video cables

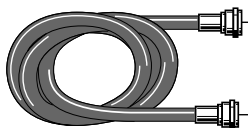

Coaxial cable

Chapter 1: Connections & Setup

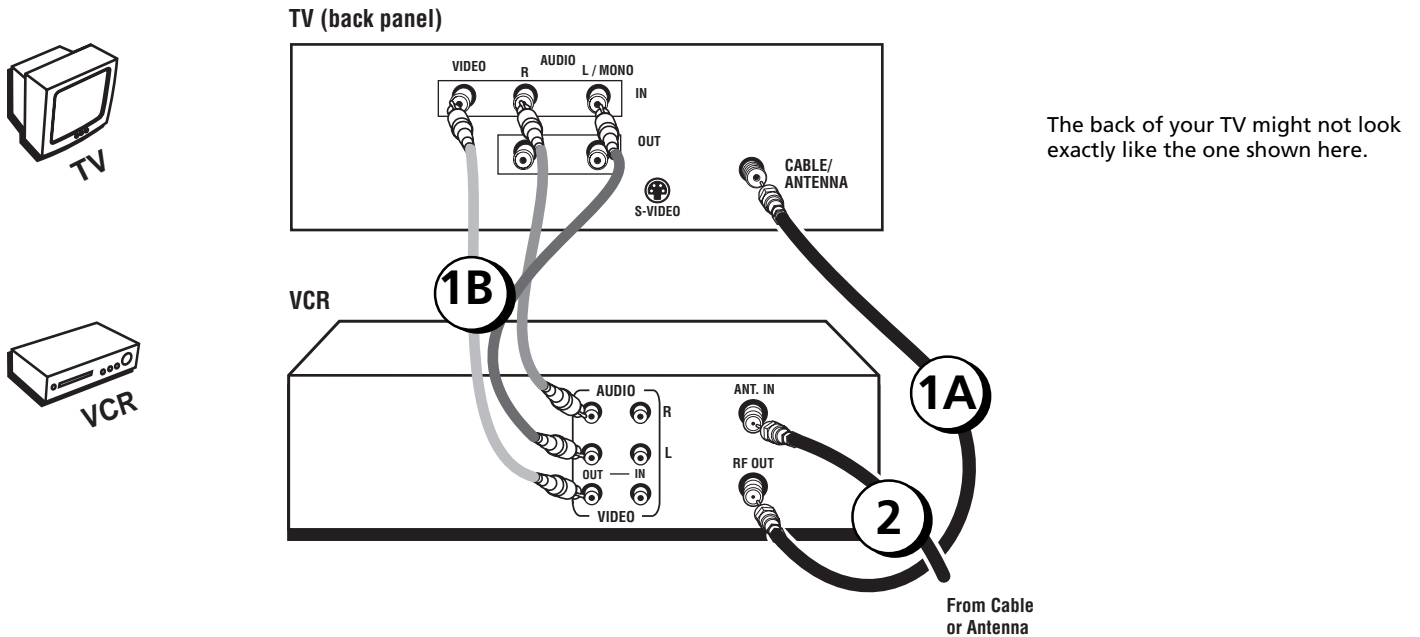

TV + VCR

1. Connect the VCR to the TV

- A. Connect one end of the supplied RF coaxial cable to the RF OUT jack on the back of the VCR and the other end to the TV's antenna in jack (sometimes labeled CABLE/ANTENNA).

– OR –

- B. Connect audio/video cables to the AUDIO OUT R and L jacks on the back of the VCR (color coded, red and white), and to the VIDEO OUT jack (yellow). Connect the other ends of the cables to the corresponding input jacks on the TV (sometimes labeled VIDEO, AUDIO L/MONO, and AUDIO R).

2. Connect the antenna/cable feed to the VCR

Connect the cable or antenna RF coaxial cable to the ANT. IN jack on your VCR.

Go To Page 8

Chapter 1: Connections & Setup

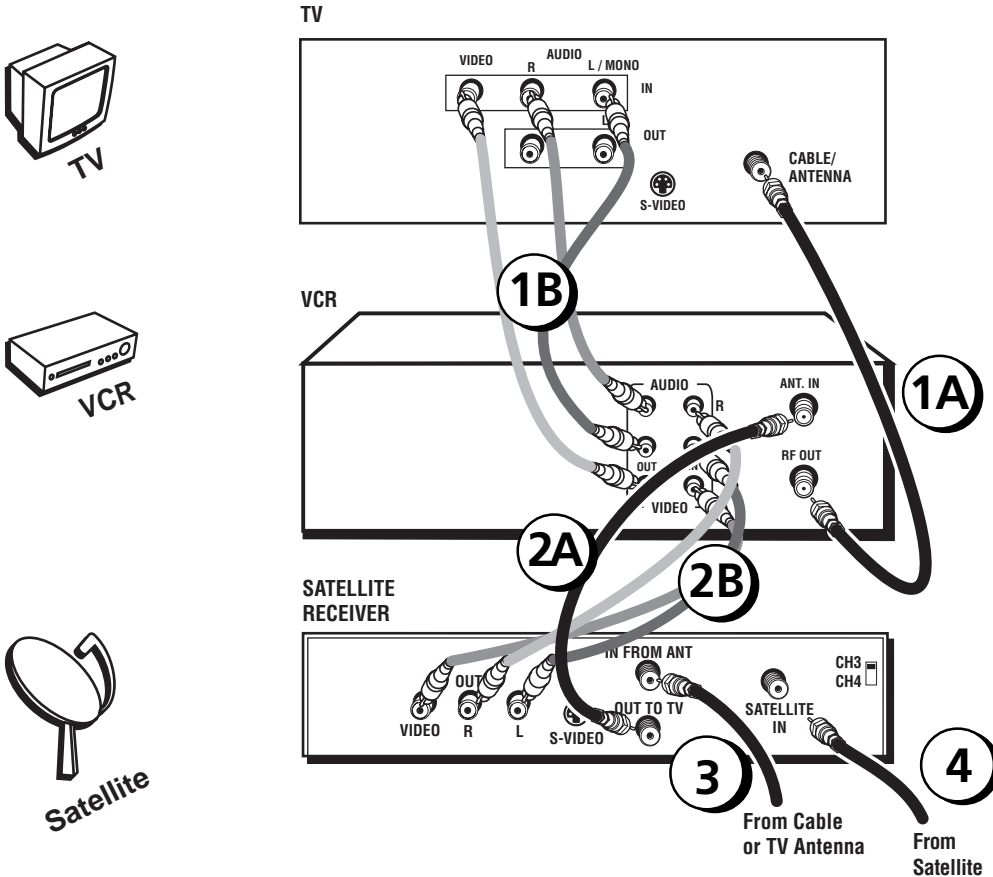

The back of your TV might not look exactly like the one shown here.

The back of your satellite receiver might not look exactly like the one shown here.

TV + VCR + Satellite Receiver

1. Connect the VCR to the TV

- A.** Connect one end of the supplied RF coaxial cable to the RF OUT jack on the back of the VCR and the other end to the TV's antenna in jack (sometimes labeled CABLE/ANTENNA).

– OR –

- B.** Connect audio/video cables to the AUDIO OUT R and L jacks on the back of the VCR (color coded, red and white), and to the VIDEO OUT jack (yellow). Connect the other ends of the cables to the corresponding input jacks on the TV (sometimes labeled VIDEO, AUDIO L/MONO, and AUDIO R).

2. Connect satellite receiver to the VCR

- A.** Connect an RF coaxial cable to the RF output jack on the satellite receiver (sometimes labeled OUT TO TV) and to the ANT. IN jack on the VCR.

– OR –

- B.** Connect audio/video cables to the AUDIO IN R and L jacks on the back of the VCR (color coded, red and white), and to the VIDEO IN jack (yellow). Connect the other ends of the cables to the corresponding output jacks on the satellite receiver (sometimes labeled VIDEO, AUDIO L, and AUDIO R).

3. Connect the antenna to your satellite receiver

If necessary, connect an antenna or cable box RF coaxial cable (not included) to the antenna input jack on the satellite receiver (sometimes labeled IN FROM ANTENNA).

4. Connect the satellite feed to the satellite receiver

If it's not already connected, connect the satellite receiver's RF coaxial cable feed (not included) to the satellite input jack on the satellite receiver (sometimes labeled SATELLITE IN).

Go To Page 8

Chapter 1: Connections & Setup

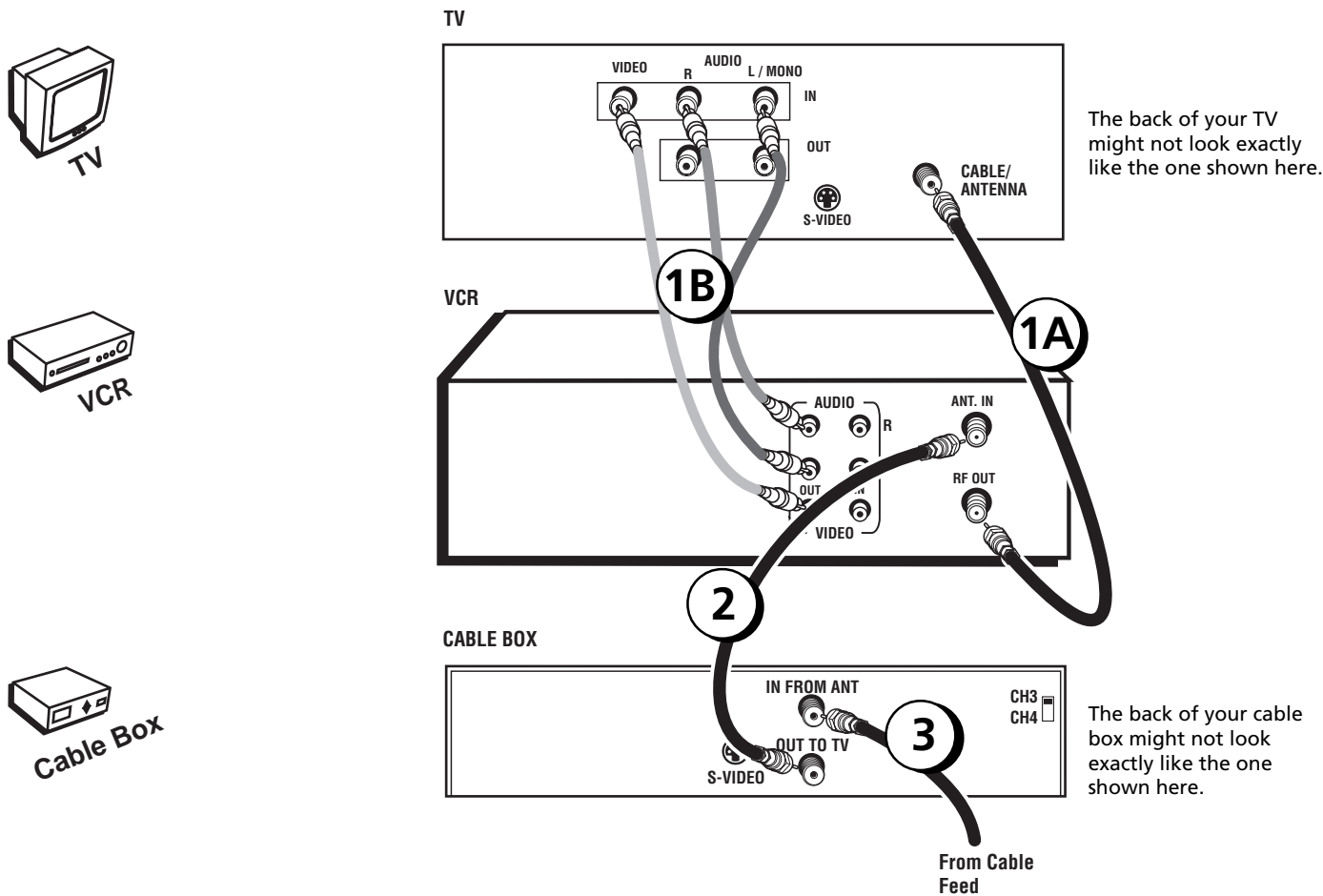

TV + VCR + Cable Box

1. Connect the VCR to the TV

- A.** Connect one end of the supplied RF coaxial cable to the RF OUT jack on the back of the VCR and the other end to the TV's antenna in jack (sometimes labeled CABLE/ANTENNA).

– OR –

- B.** Connect audio/video cables to the AUDIO OUT R and L jacks on the back of the VCR (color coded, red and white), and to the VIDEO OUT jack (yellow). Connect the other ends of the cables to the corresponding input jacks on the TV (sometimes labeled VIDEO, AUDIO L/MONO, and AUDIO R).

2. Connect the cable box to the VCR

Connect one end of a second RF coaxial cable (not included) to the cable box's TV output jack (sometimes labeled OUT TO TV) and the other end to the ANT. IN jack on the VCR.

3. Connect the cable feed to your cable box

If it's not already connected, connect the RF coaxial cable feed (not included) to the antenna input jack on the cable box (sometimes labeled IN FROM ANTENNA).

Go To Page 8

Chapter 1: Connections & Setup

Put Batteries in the Remote Control

1. Insert the batteries matching the polarities (+ and -) on the batteries with the diagram in the battery compartment.

Turn on the TV and VCR

1. Turn on the TV (if the TV you've connected to the VCR is an RCA, GE, Proscan, or Scenium TV, press the TV button on the remote packed with your VCR).
2. Tune the TV to the correct Video Input Channel.
 - If you used a coaxial cable to connect your VCR to your TV, tune the TV to channel 3. Your TV must be set to channel 3 the first time you set up the VCR. See page 28 for instructions on how to change the output channel once you have started setup.
 - If you used audio/video cables to connect your VCR, tune the TV to its Video Input Channel (see page 38).

Using the Remote Control to Choose On-screen Menu Items

To select an on-screen item, press the MENU button, then the number button on the remote control that matches the on-screen number. Selecting a menu item can take you to another menu, activate a choice, or activate a data entry field (such as the hour field in the *Set Time* menu).

If a number doesn't appear next to an on-screen menu, use the arrow buttons to highlight an item on the screen, and press OK to select the highlighted item.

```
Select a language.  
Seleccione un idioma.  
Choisissez une langue.
```

```
1>English  
2 Español  
3 Français
```

The first time you turn on the VCR, you'll be asked to select the language for the on-screen menus.

Complete the on-screen setup guide

To help you use the VCR as quickly as possible, an on-screen setup guide walks you through several important menu screens the first time you turn on your VCR. The first menu item asks you to select the language for the on-screen menus. The other setup menu items are listed in this section.

LANGUAGE menu: determines the language in which the on-screen displays and menus appear.

```
VCR MAIN MENU  
1 Timer Recordings  
2 Time  
3 Channels  
4 Setup  
5 Preferences  
6 Audio  
7 Language  
0 Exit
```

If you ever need to change some of the settings in any of the menus that appear in the setup procedure, choose *Setup* (press 4 on the remote) from the *VCR MAIN MENU*.

Note: If you ever need to change some of the settings in any of the menus that appear in the setup procedure, go to the *VCR MAIN MENU* (press MENU on the remote) and choose *Setup* (press 4).

Chapter 1: Connections & Setup

CHANNELS menu – submenus are listed below.

Auto Channel Search – automatically searches for channels so that they are stored in the VCR's channel list (the list of channels that are accessed when you press the CH +/- buttons).

Add/Remove Channels – allows you to manually add or remove channels from the channel list. This is helpful if the channel's signal is weak. See Auto Channel Search on page 27.

Signal Type – press 3 to go back and forth between the two signal types: *Cable* and *Antenna*. When the setting you want is on the screen, press 0 to Exit (the *VCR MAIN MENU* appears and your signal setting is saved). Press 0 again to return to normal viewing.

```
CABLE BOX SETUP
Do you use your cable
box to receive ALL
channels or only SOME
channels?
1 ALL channels
2 Only SOME channels
3 Cancel setup
```

```
CABLE BOX SETUP
On what channel does
the VCR receive signals
from the cable box?
(usually 3, 4, or Video)
--
Enter 01-13 or INPUT
Press MENU to cancel
```

```
TIME
1 Set Time and Date
2 Auto Clock Set: ON
3 Set Time Zone
4 Set Daylight Saving
Time Data was found
on channel 20.
0 Exit
```

```
SET TIME ZONE
What is your Time Zone?
1 Eastern
2 Central
3 Mountain
4 Pacific
5 Alaska
6 Hawaii
7 Automatic
Press MENU to continue
```

Cable Box Setup – This setup applies **only** when all channels are received through a cable box. In this case, the VCR will default to the channel used to view cable box programming during timer recordings. If you use your cable box to receive only some channels, you won't be able to use this feature and will have to change the channels on your cable box and VCR manually.

If you choose *ALL Channels*, enter the output channel of the cable box (usually 03 or 04), or if A/V jacks connect the VCR to the cable box, press the INPUT button on the VCR's remote control.

TIME menu – accesses settings for VCR's time and date information.

Set Time and Date – allows you to manually set the VCR's time and date information instead of using the Auto Clock Set feature. When the *SET TIME AND DATE* menu is on the screen, use the number buttons on the remote to enter the information — you must press 0 before single digits (for example, 03/17/02 for March 17th, 2002).

Auto Clock Set – press the 2 button repeatedly to switch between on and off. If you turn Auto Clock off, you'll need to manually set the time and date in order for the VCR's recording features to work. (Only available in some areas.)

Set Time Zone – When the *SET TIME ZONE* menu is on the screen, use the number buttons on the remote to enter the information.

If you select *Automatic* for your time zone, the VCR sets the clock using the first time information it finds from the broadcast signal. If the time set isn't correct, select another time zone or set the time manually.

Set Daylight Saving – adjust this setting to allow for daylight saving time (DST).

If you choose *Automatic* for the time zone, the VCR sets the clock using any DST information broadcast in the channel's signal.

Note: All additional menu items are explained in Chapter 4.

Chapter 1: Connections & Setup

VCR Basics

Once your initial settings are complete, you can begin using your VCR. In order to begin, you must first understand some basic concepts.

Playing a tape

1. Tune the TV to your VCR viewing channel (03, 04, or the Video Input Channel).
2. Insert a tape in the VCR.

If the Auto Play feature is set to ON, the tape automatically begins playback (the safety tab on the tape must be removed).

- Press FORWARD or REVERSE to cue the tape to the desired position during Play mode.
- To advance the tape 30 seconds at a time during Play mode, press the SEARCH button on the remote control (each time you press SEARCH, 30 seconds is added to the amount of tape that is scanned — up to 5 minutes).
- Press PLAY (if necessary) to begin tape play.
- Press PAUSE to stop action. For slow-motion playback, press FORWARD and/or REVERSE (while picture is paused). To move one frame at a time, press FORWARD on the remote (while paused).
- Press TRACKING + or – to remove any streaks from the picture, if necessary.
- Press STOP/EJECT (or STOP on the remote) to stop playback.

Automatic Rewind

The VCR automatically rewinds the tape if it reaches the end of the tape during playback. While rewinding, you can press the ON•OFF button (the VCR will turn off after it rewinds the tape). If the tape has no safety tab, it will be ejected.

Tape Eject

Press the STOP/EJECT button on the VCR when stopped to eject the tape. You can also press and hold the remote control's STOP button for three seconds.

Basic Recording

1. Set the tape speed by pressing the SPEED button on the remote control (see Tape Speed on page 30 for information about recording speeds).
2. Press the RECORD button to begin recording.
3. Press the STOP button to halt recording.

If you just want to pause the recording for a short time (like during a commercial), press PAUSE instead of STOP.



Check the Safety Tab

Make sure there is a tape in the VCR with its safety tab in place. You cannot record on a tape if the safety tab has been removed. If the safety tab is removed and you want to record, simply cover the hole with adhesive tape.

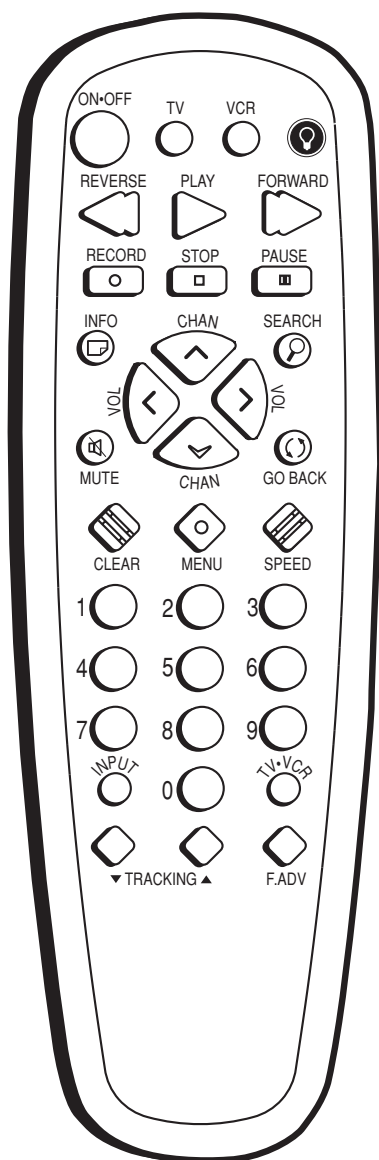

Notes: The TV and VCR buttons also turn on most RCA, GE, Proscan, and Scenium products.

The remote control shown here has a backlight button and is included with the VR712HF only. The VR648HF remote doesn't have a backlight button.

The Buttons on the Remote Control

(0-9) Number buttons Selects channels up to 99 by pressing two number buttons. Selects 3-digit channels by pressing and holding 1 until 1-- appears on screen. Then press the other two numbers.

Backlight Lights up some of the buttons in the dark (VR712HF only).

CHAN up and down Selects next higher or lower channel in the VCR's channel list.

FORWARD Fast forwards the tape when the VCR is stop in stop mode. This button also searches forward if pressed during playback. During play-pause mode, this button starts slow-motion advance and each press of the button during slow-motion advance increases the speed incrementally.

F. ADV (Frame Advance) Advances a tape one frame at a time during play-pause mode.

GO BACK Switches between the current and previous channels.

INFO Shows the status displays on screen of the VCR or TV (whichever component is set as the remote control's active device).

INPUT Selects between the Video Input Channel and the VCR's tuner. Video Input Channel refers to the signal coming from the component connected to audio/video input jacks on the back or front of the VCR (L1 designates the back panel A/V jacks and L2 designates the front panel A/V jacks).

MENU Displays the VCR's on-screen menu system.

MUTE Reduces the TV's volume to a minimum level on some compatible TVs.

ON•OFF Turns the VCR on or off when the remote control is set to operate the VCR. Also turns other compatible components on or off.

PAUSE Pauses playback or recording modes. Press PAUSE again to return to active playback or recording.

PLAY Plays a tape.

RECORD Starts record mode on tapes with the safety tab intact. Pressed repeatedly to set a recording duration for the Express Recording feature.

REVERSE Rewinds the tape when the VCR is in stop mode. Searches backward through a tape during playback mode. Starts slow motion playback during play-pause mode with each press of the button decreasing the slow-motion speed.

SEARCH Displays the MOVIE ADVANCE screen for prerecorded movies. When pressed repeatedly, this button also displays Index and Zero Search menus on screen. During playback mode, pressing SEARCH starts COMMERCIAL ADVANCE skipping.

SPEED Overrides the default recording speed (either SP or SLP).

STOP Stops the current VCR function (record, playback, rewind, etc).

TRACKING up and down Allows for manual reduction of streaks that may appear in the picture during playback mode. Reduces picture "jitter" during play-pause mode.

TV Turns on a compatible RCA, GE, Proscan, or Scenium TV and puts the remote control in TV-operating mode. Also used with the ON•OFF button to turn on a different brand of TV (if programmed).

Chapter 2: Remote Control

Tip

To turn off all the RCA, GE, Proscan, and Scenium components that are connected to the VCR, press **ON•OFF** twice within two seconds.

This feature only works with most RCA, GE, Proscan, and Scenium products.

TV•VCR Switches between displaying the picture from the VCR or the TV.

VCR Turns on the VCR and puts the remote control in VCR-operating mode.

VOL < and > Raises and lowers the television's volume of some compatible TVs.

Using the INPUT Button

Use the INPUT button to scroll through the available Video Input Channel sources (Video1 and Video2) and regular broadcast signals. The Video Input Channels allow you to view images from a device connected to the VCR (like a camcorder).

1. Press the remote control's VCR1 or VCR2 button (whichever is set to operate your VCR) to enter VCR-operating mode. Make sure that the VCR is turned ON.
2. Press the remote control's INPUT button to tune to the Video Input Channel. *Video1* represents the rear A/V jacks and *Video2* represents the front A/V jacks).
3. To tune back to the broadcast signal you were previously watching through the VCR, press the INPUT button again.

Programming the Remote to Operate Your TV

The remote can be programmed to operate most brands of remote controllable TVs. The remote is already programmed to operate most RCA, GE, Proscan, and Scenium TVs.

Find Out If You Need to Program the Remote

To determine whether the universal remote needs to be programmed for your TV, turn the TV ON. Point the remote at the TV, and press the TV button. Then press ON•OFF or CHAN up or down to see if the TV responds to the remote commands. If the TV does not respond, the remote needs to be programmed.

Important: The remote may not be compatible with all models of all brands of components. It also may not operate all functions of the remote that came with your component.

Important

You must continue pressing the component button while you enter the code.

Let's say you have a Zenith TV. To program the universal remote to operate the VCR, you would:

Press and hold the TV button while you enter the first code listed for Zenith in the TV Codes column.

Release the TV button. Press ON•OFF to see if the TV responds. If it doesn't, follow the same steps, but enter the second code for Zenith TVs instead of the first.

Programming the Remote

Using Direct Entry

1. Turn on your TV.
 2. Look up the brand and code number(s) for the TV on the code list in this section.
 3. Point the remote at the TV.
 4. Press and hold the TV button on the remote.
 5. Enter the code from the remote control code list on the following page.
 6. Release the component button, and then press ON•OFF to see if the TV responds to the command. If it doesn't, try pressing the TV button and then ON•OFF again.
- If you get no response, repeat these steps using the next code listed for your brand, until the TV responds to the remote commands.
 - If you try all the codes for your TV brand and none work, the remote is not compatible with your TV.

Note

Some of the remote's buttons might operate differently for other components, especially when you're using another component's menu system.

How to Use the Remote After You've Programmed It

Because this remote control can also control a TV, it uses operational modes triggered by the component buttons. For example, if you want the remote to control the TV, you would press the TV button to put the remote into TV mode before you could control the TV.

1. Press the appropriate component button (TV or VCR) to set the remote to control the component.
2. Press ON•OFF to turn the component ON or OFF.
3. Use the remote buttons that apply to that component.

Notes:

- The remote may not be compatible with all brands and models of components. It also may not operate all functions of the remote that came with your component.
- If you keep pressing buttons and nothing happens, the remote is probably in the wrong mode. You must press the component button that matches the component you want to operate (i.e., if you want to operate the VCR, press VCR on the remote control to put the remote in VCR mode.)

Code List

TV Codes

Akai	03	NAD	07
AOC	06,12	NEC	06
Candle	06	Panasonic	04, 08, 11
Citizen	06	Philco	04, 06, 12
Colortyme	06	Philips	03, 04, 06, 12
Concerto	06	Pioneer	06
Curtis Mathes	01,06	Portland	06, 12
Daewoo	06,12	Proscan	01
Daytron	06	Proton	06
Electrohome	06,12	Quasar	11
Emerson	06	Radio Shack	01, 05, 13
Envision	05, 06	RCA	01, 06, 12
Fisher	05, 08	Realistic	05
GE	00, 01, 06, 11	Sampo	06
Goldstar	06,12	Samsung	06, 09, 12
Hallmark	06	Sanyo	05, 08
Hitachi	06,14	Sears	01, 05, 06, 07, 08, 10, 12
Infinity	04	Sharp	06,13
J C Penney	00, 01, 06, 09, 12	Sony	03
JBL	04	Soundesign	06
Jensen	06	Sylvania	04, 06, 12
JVC	10, 11	Technics	11
Kawasho	03, 06	Techwood	06
Kenwood	06, 12	Teknika	06
Loewe	04	TMK	06
Luxman	06	Toshiba	05, 07, 08, 09
LXI	04, 05, 07	Universal	00
Magnavox	04, 06, 12	Victor	10
Marantz	04, 06	Wards	00, 01, 04, 06, 12, 13
MGA	06, 12	Yamaha	12
Mitsubishi	06, 12	Zenith	02
MTC	06		

This page left blank intentionally.

Recording Features

Your VCR provides many ways to record programming. Basic recording is explained on page 10. The following recording techniques are also available.

- **Recording** – lets you press one button to record a program.
- **Express Recording (XPR)** – allows recording to start while a program is being watched. This feature automatically stops recording after a designated period of time.
- **Timer Recording** – program the VCR for a daily, weekly, or onetime recording which will automatically start and stop at the times you set.

Express Recording (XPR)

Use XPR to quickly record the remaining portion of a program being watched. XPR is a great way to capture the end of a sporting event that has run into overtime or a live broadcast that runs long. XPR works in 30- or 60-minute increments. You can capture the last 30, 60, 90, etc. minutes of programming (depending on tape length), up to four hours total.

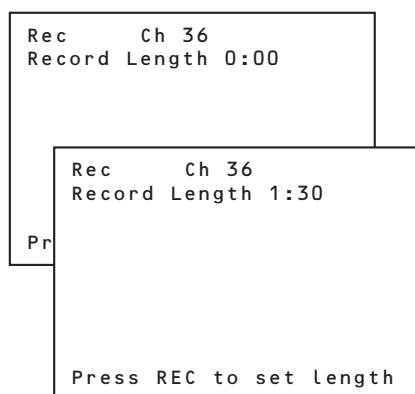

To Activate XPR:

1. Turn on the VCR and tune it to the channel with the desired programming.
2. Insert a tape with its safety tab in place into the VCR. Make sure it is cued to record at the proper starting point.
Note: To override the preferred tape speed setting, press the **SPEED** button on the remote control repeatedly to toggle between **SP** and **SLP** choices.
3. Press the **RECORD** button to start recording.
4. Repeatedly press **RECORD** to set up the recording duration.
 - Press **RECORD** until *RECORD TIME 0:00* appears.
 - Each press of the **RECORD** button adds 30 or 60 minutes of recording time.
 - The VCR automatically turns off after it has recorded the set amount of time.
 - To stop an XPR recording, press and hold the **STOP** button for several seconds until *STOP* appears on the VCR on-screen display.

Timer Recording

You can set up to 8 different TV programs to be recorded. Before a Timer Recording will work, the VCR needs to be set up correctly.

- VCR's clock must be set correctly.
- If you've set up the VCR for a cable box for all channels, the output of your cable box appears in the channel item of the *Timer Recordings* menu.
- *PROGRAMS OVERLAP* appears if two programs whose times overlap are entered.
- The timer indicator appears in the display when you turn off the VCR and a timer recording has been set. The timer indicator flashes if there is no tape in the VCR when a timer recording has been set and the unit is turned off.
- For a cable box or satellite receiver, turn it on and tune it to the channel you want to record before the recording is to begin.
- Insert a tape with its safety tab in place and enough tape to record the program.

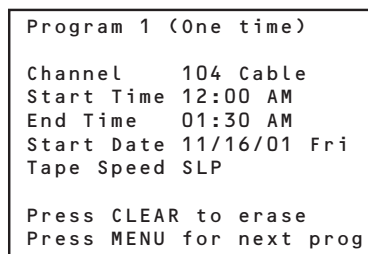
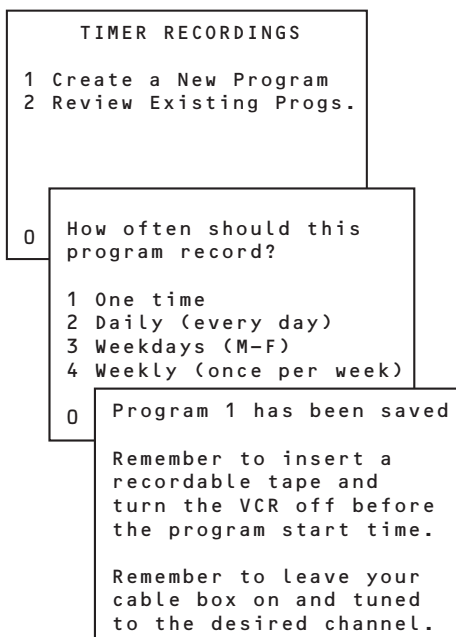

To Set Up as Many as Eight Timer Recording Programs:

1. Press the MENU button to display the *VCR MAIN MENU*.
2. Press the 2 button to choose *Timer Recordings*.
3. Press the 1 button to choose *Create a New Program*.
4. Select how often you want the program to record.
5. Enter the data for the program with the number buttons.
The data includes the channel number, and start and end times (including AM or PM). The start date is automatically entered based on the VCR clock. Both the recording date and speed can be changed.
6. Review the information to make sure it is correct.
7. Press the MENU button to save.

Stopping a Timer Recording

To stop or cancel a timer recording in progress (even an Express Recording):

Press and hold the STOP button for several seconds until *STOP* appears in the on-screen display.

Reviewing and Clearing Programs

To review programs that you have already set up:

1. Press the MENU button to display the *VCR Main Menu*.
2. Press the 2 button to choose *TIMER RECORDINGS*.
3. Press the 2 button to choose *Review Existing Progs.*
 - To erase, press CLEAR.
 - To see the next saved timer recording program, press MENU.

Index Search

The VCR has a VHS Index Search System that automatically records index marks on the tape every time you start a recording. During playback you can locate the program you want to play by the number of index marks or by scanning. The VCR will search forward or reverse from the location you are at on the tape.

```
INDEX SEARCH
Press REV or FWD
to begin scanning
OR
enter a specific
index number
--
Press SEARCH to exit
```

To Activate Index Search:

1. While playing back, press the STOP button to stop the tape.
2. Press the SEARCH button on the remote control to display the *INDEX SEARCH* screen on the TV screen.
3. If you want to search through a certain number of index marks, press two number buttons to enter the number of marks you want to search. Press the CLEAR button on the remote control to correct an entry.
4. Press the FORWARD button to search forward or the REVERSE button to search in reverse. The VCR will locate your index mark and begin playback. If you did not enter a specific index number, the VCR will locate the next index mark and begin playback.
5. Press STOP to stop Index Search.

Notes: Certain index marks may be missed by the VCR including:

- Marks too close to the current location of the tape.
- Those at the beginning of a recording lasting five minutes or less.
- Index marks that start at the beginning of the tape.

Zero Search

The Zero Search feature enables the VCR to quickly return to the 0:00:00 counter reading from anywhere on the tape. This is a convenient way to play a segment of the tape several times.

```
ZERO SEARCH
Current tape counter is
2:17:25
Press REV to go to
0:00:00
Press SEARCH to exit
```

1. Cue a tape to the spot you wish to return to.
2. Press the CLEAR button twice to reset the counter to 0:00:00.
3. Continue playing the tape.
4. Press the STOP button.
5. Press the SEARCH button repeatedly until the *ZERO SEARCH* menu appears on screen.
6. Press the REVERSE button to return to 0:00:00 on the tape.
7. Repeat as necessary.

Pro-Tect Plus™ Locking Feature

To disable VCR usage or to protect set timer recordings, the unit can be locked so that the buttons on the VCR or remote control don't work.

- **To Lock:** Press and hold either the remote control's ON•OFF or VCR button until the VCR indicator on the front of the VCR goes out. The clock blinks if a button is pressed while the VCR is locked.
- **To Unlock:** Press and hold either the remote control's ON•OFF or VCR button until the clock stops blinking on the front of the VCR. This is the only way to unlock the VCR.

Chapter 3: VCR Features

Time Counter

The time counter shows the actual time used when recording or playing back a tape. The time counter helps locate the beginning or end of recorded events. It resets to 0:00:00 whenever a tape is ejected from the VCR.

For example, if you record a 30-minute program at the beginning of a tape, rewind it, and then want to go to the end of the first program to start another recording:

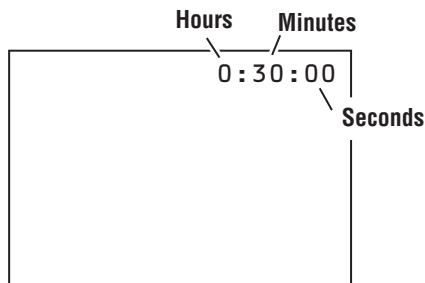

1. Press the INFO button **twice** to display only the time counter.
2. Press the CLEAR button to reset the time counter to 0:00:00.
3. Press the FORWARD button to advance a tape until the time counter reads 0:30:00.
4. Press the STOP button. This is the approximate end of a 30-minute program (you may want to press the PLAY button to verify). When the tape is cued correctly, you can begin recording.
5. Press the INFO button to remove the time counter from the screen and return to the normal display mode.

Info Display

To find out the status of the VCR, press the INFO button on the remote control. Each time you press INFO, different information appears on the screen. See the following examples.

Note: The date and time must be set before they can be displayed.

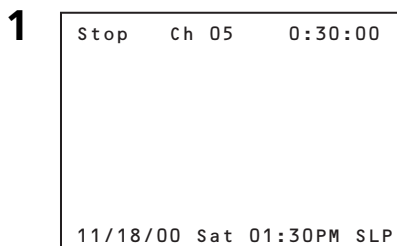

On-screen display (times out)

1. Press the INFO button to show the on-screen displays. The current time is also displayed in the VCR's front panel.

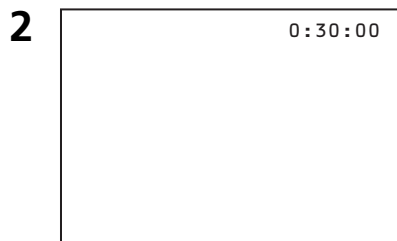

Time counter only (does not time out)

2. Press INFO again to have only the time counter remain on the screen. The time counter is also displayed in the VCR's front panel for a short time.



No displays will appear (useful for dubbing)

3. Press INFO again to have no displays appear on the TV screen. The time counter remains in the VCR's display panel. This is useful for dubbing tapes.
4. Press the INFO button again to return to the normal display. The current time is displayed in the VCR's display panel.

Note: Turning off the VCR also resets the displays.

COMMERCIAL ▶▶ ADVANCE®

This feature uses patented technology to detect and mark most commercials on your tape for any recording that is more than 15 minutes long. Once recording is finished, the VCR rewinds the tape to the beginning of the recording and determines where the commercials are located. It then marks the beginning and end of the detected commercial segments, and when finished, returns the tape to the end of the recording. **It does not erase commercials from the tape.**

During playback, the VCR automatically skips the detected commercial segments, or you can chose to manually skip them. This feature reduces three minutes of commercials to approximately 8-12 seconds of fast forwarding in the SLP speed. You can select a background display of blue or see the video as the commercials are skipped.

Because television signals do not indicate where commercials are located, this feature finds and marks them through a set of formulas based on how television is broadcast today. Since television stations broadcast differently and insert their own commercials, you may experience some variations in this feature's effectiveness. Station promotions, identifications, and announcements are not considered commercials, but might be skipped.

```
PREFERENCES
1 Remote Control: VCR1
2 Auto Play: ON
3 Auto TV/VCR: ON
4 EnergySaver: 2:00
5 Front Panel: AUTO
6 Tape Speed: SLP
7 Set Auto Repeat
8 COMMERCIAL ADVANCE
0 Exit
```

1. Press MENU to display the *VCR MAIN MENU*.
2. Press 6 to display the *PREFERENCES* menu.
3. Press 8 to display the *COMMERCIAL ADVANCE* menu.

Now you can select one of the *COMMERCIAL ADVANCE* features.

COMMERCIAL ADVANCE Marking

Press 1 to turn commercial Marking *ON* or *OFF*.

- Select *ON*, and the VCR will mark commercials within approximately 30 seconds for the following types of recording:
 - **Timer, Timer with VCR Plus+, or Express Recording** The VCR automatically marks commercials after the power is turned off.
 - **Recording** The VCR prompts you to mark the commercials when the recording is stopped.
- Select *OFF* and the VCR will not mark the commercials.

```
COMMERCIAL ADVANCE
1 Marking: ON
2 Playback: AUTO
3 Display: Blue

0 Exit
```

```
The VCR is waiting to
mark commercials in the
program you recorded.

1 Mark them now
2 Mark them later
3 Don't mark commercials

The VCR will begin
marking in 30 seconds...
```

COMMERCIAL ADVANCE	
1 Marking:	ON
2 Playback:	AUTO
3 Display:	Blue
0	Exit

COMMERCIAL ADVANCE Playback

Press 2 to switch between Playback: *AUTO* and *MANUAL*.

- Select *AUTO* to have the VCR automatically advance through the blocks of marked commercials.

It works with most 30, 45, and 60-second commercials.

A commercial group starting with the first two minutes or last two minutes of a recording will not automatically be skipped.

A commercial will not be skipped if a recording starts in the middle of a commercial segment, one isolated commercial is shown without others, or a commercial is longer than one minute. Press FORWARD to scan through the commercial.

Part of a recorded program may be skipped if the program segment is between commercials and less than one minute or there are frequent dark and quiet scenes.

- Select *MANUAL* and the VCR won't advance through the blocks of marked commercials until you press SEARCH.

To Override Automatic Skipping

If part of the program you've recorded is passed over, you can temporarily override the automatic skipping feature of COMMERCIAL ADVANCE.

1. While the desired portion of the program is being skipped, press the PLAY or STOP button on the remote control or VCR front panel.
2. To view the portion of the tape that was skipped, rewind the tape back to a position before the skipping started using the REVERSE button.
3. Press the PLAY button to start playback. The portion of the tape will no longer be skipped.

Automatic skipping will be enabled again after the VCR detects the end of the commercial group.

Notes: If you press SEARCH during playback of material other than commercials, the VCR advances to the end of the next "marked" commercial block and resumes playback.

The VCR resumes playback when it reaches the end of the marked commercials.

COMMERCIAL ADVANCE Display

Press 3 to switch between Display: *BLUE* or *VIDEO*.

- Select *BLUE* to display a blue background when the VCR advances through the block of marked commercials.
- Select *VIDEO* to display the recorded video when the VCR advances through the block of marked commercials.

MOVIE ▶ ADVANCE®

MOVIE ADVANCE helps you locate certain parts of prerecorded movies (rented or purchased). This feature works two ways: 1) you can go to the beginning of the movie, or, 2) you can skip from one preview to the next. MOVIE ADVANCE works only on tapes with the safety tab removed and recorded in SP speed.

```
MOVIE ADVANCE
What type of tape
is this?

1 Purchased/Rented Movie
2 Home Recording
3 Other

Press CLEAR to cancel
```

```
MOVIE ADVANCE

Would you like to go to
the start of the movie
or to the next preview?

1 Go to movie
2 Go to preview

Press CLEAR to cancel
```

```
MOVIE ADVANCE

The movie is ready.
Press PLAY to start.

Press STOP to cancel
```

```
Searching for preview

Press SEARCH to reverse
Press STOP to cancel
```

1. To select *MOVIE ADVANCE*, insert a tape with its safety tab removed and press the SEARCH button on the remote control.
2. Press 1 if the tape is a purchased or rented movie, press 2 if it's a recording made at home, or press 3 if it's something else, you don't know, or you do not want to select *MOVIE ADVANCE*.

Pressing 2 or 3 gives the same response and takes you to a different search feature. If you accidentally make a wrong selection, press STOP • EJECT on the VCR (STOP on remote) and reinsert the tape. Press SEARCH.

If you press 1, the *MOVIE ADVANCE* menu appears.

3. Press 1 to advance directly to the beginning of the movie or press 2 to view the first (next) preview.
 - Press 1 to *Go To Movie*. The following screen appears with a blue background.

When the movie is found, *The movie is ready. Press PLAY to start*, appears.

Note: You can press the STOP button to cancel the MOVIE ADVANCE search.

- Press 2 to *Go To Preview*. The on-screen display will tell you that the VCR is looking for the start of the next preview.

When a preview is detected, the VCR cues it and begins playing.

To Override the Show Previews Mode:

Press the SEARCH button while a tape is being searched.

Pressing the SEARCH button while:

- The tape is rewinding will begin searching for the start of the next preview or long commercial.
- The tape is searching forward will reverse the tape back to the beginning of the current preview.
- The VCR is playing will advance the tape to the start of the next preview, long commercial, or the start of the movie (whichever comes first).

This page left blank intentionally.

```
VCR MAIN MENU
1 Timer Recordings
2 Time
3 Channels
4 Setup
5 Preferences
6 Audio
7 Language
0 Exit
```

If you ever need to change some of the settings in any of the menus that appear in the setup procedure, choose Setup (press 4 on the remote) from the *VCR MAIN MENU*.

```
TIME
1 Set Time and Date
2 Auto Clock Set: ON
3 Set Time Zone
4 Set Daylight Saving

Time Data was found
on channel 20.

0 Exit
```

```
CHANNELS
1 Auto Channel Search
2 Add/Remove Channels
3 Signal Type: CABLE
4 Cable Box Setup
5 VCR Output Channel: 3

0 Exit
```

Explanation of the Menu System

The on-screen menus you saw the first time you turned on your VCR were explained in Chapter 1. This chapter lists other menus that you can access through the *VCR MAIN MENU* (press MENU on the remote control). The quickest way to select a menu is to press the number button on the remote control that matches the number next to the item. Some menus have on-screen instructions for more complicated settings.

Timer Recordings

The Timer Recordings feature programs the VCR to record automatically. This feature is explained in detail on page 18.

Time

The TIME menu options appeared during initial setup and are explained on page 9.

Channels

Channels tells the VCR where to find channels and stores them in the VCR's channel list.

Auto Channel Search

Use Auto Channel Search to place all available channels in memory.

If you ever change cable or antenna signals, you may need to run the Auto Channel Search feature again.

Select one of the three options:

Cable TV searches for cable stations.

Antenna searches for local broadcast stations.

Detect Automatically selects the appropriate input automatically.

Note: With *Detect Automatically*, a strong cable or antenna signal in your area may cause channels to be detected inaccurately. If this should happen, you will need to select either *Cable TV* or *Antenna* manually.

When scanning is complete, the VCR tunes to the lowest channel available. After completing Auto Channel Search, press the remote control's CHAN up or down buttons to select active channels.

ADD/REMOVE CHANNELS

Channel 115
is presently ADDED

Press CLEAR to remove
Press MENU to exit

Add/Remove Channels

Your VCR may come with a list of channels preset at the factory. Even though it may come with such a list, you may want to add or delete certain channels.

Note: If you use a cable box to view *all channels*, this step is not necessary.

To go to the channel you want to add or remove, use the remote control's CHAN up or down buttons or enter a specific channel number using the number buttons.

To remove a channel from the channel list, press CLEAR. To add a channel to the channel list, press INFO.

Note: To view active channels, use the remote control's CHAN up and down buttons. You can also access channels that aren't available in the active channel list by using the remote control's number buttons to enter the specific channel number.

Signal Type

This feature is useful if your cable signal goes out; it allows you to switch to a regular antenna for alternate television reception.

From the *Channels* menu, choose between *Signal Type: Cable* or *Antenna* by pressing the 3 button until the correct signal type is shown.

CABLE BOX SETUP

Do you use your cable
box to receive ALL
channels or only SOME
channels?

- 1 ALL channels
- 2 Only SOME channels
- 3 Cancel setup

Cable Box Setup

This setup applies **only** when all channels are received through a cable box. Cable box setup is explained in detail on page 9.

If you press MENU, the
VCR output channel
switches to channel 4.

VCR Output Channel

Use this option to change the VCR's output channel. The default is channel 3. To change the output channel to channel 4, press the MENU button. If you change the output channel to 4, you must tune your TV to channel 4 to watch channels through the VCR or play a tape.

VCR MAIN MENU	
1	Timer Recordings
2	Time
3	Channels
4	Setup
5	Preferences
6	Audio
7	Language
0	Exit

PREFERENCES		
1	Remote Control:	VCR1
2	Auto Play:	ON
3	Auto TV/VCR:	ON
4	EnergySaver:	2:00
5	Front Panel:	AUTO
6	Tape Speed:	SLP
7	Set Auto Repeat	
8	COMMERCIAL ADVANCE	
0	Exit	

The *PREFERENCES* menu allows changes to be made to a variety of different VCR features.

Setup

Use the Setup menu to change any of the menus in the initial setup procedure. Press MENU to go to the *VCR MAIN MENU*, then press the 5 button. The Setup menu is explained in detail on pages 8-9.

Preferences

The settings in this menu let you customize your VCR features.

Remote Control

If you have a universal RCA or GE remote with VCR1 and VCR2 buttons and a second VCR, you can set this VCR to be controlled with the VCR2 button. This allows you to control both VCRs from one remote.

Auto Play

With Auto Play turned on (the factory default setting), the VCR automatically starts playback when you insert a tape with its safety tab removed.

Auto TV/VCR

Auto TV/VCR Controls whether the VCR's TV/VCR setting changes automatically to VCR-viewing mode when turned on,

Note: Pressing the TV•VCR button will switch between VCR and TV-viewing modes. When in VCR-viewing mode, *VCR* is displayed on the front panel. The VCR indicator turns off when in TV-viewing mode.

EnergySaver

By default, the VCR automatically turns off after two hours of inactivity. When the EnergySaver option is selected this can be changed by pressing the 4 button repeatedly to change the time delay or to disable the feature altogether.

Front Panel

You can change the brightness level of the VCR's front panel display. In the *PREFERENCES* menu, press the 5 button repeatedly to toggle between options:

- *AUTO* means the display brightens when the VCR is on and dims when the VCR is off. The display turns off after 5 minutes to conserve power if the VCR is off. This setting is the default.
- *BRIGHT* keeps the display bright whether the VCR is on or off.
- *DIM* keeps the display at a low brightness level whether the VCR is on or off.

Note: If the Front Panel feature is set to *AUTO*, the display turns off after 5 minutes to conserve power. To keep the display on all the time, select either *BRIGHT* or *DIM*.

Chapter 4: On-Screen Menus

Tape Speed

You can choose a preferred tape speed for recording; either Standard Play (SP) or Super Long Play (SLP). The speed selected appears on the screen and in timer recording menus.

Recording Times

Cassette SP	SLP
T-120 2 Hr	6 Hr
T-160 2 Hr/40 Min	8 Hr

Recording Speeds

SP (Standard Play)

Gives the best quality recording, but fewer programs can be recorded on the tape.

SLP (Super Long Play)

Gives three times the recording time of tapes recorded in SP mode.

Set Auto Repeat

You can set the VCR to play the same segment of a tape over and over in a repeating loop.

The *Set Auto Repeat* menu will ask for a loop end time to be specified. To turn off Set Auto Repeat, press the CLEAR button.

COMMERCIAL ADVANCE

The COMMERCIAL ADVANCE feature detects and marks commercials so that they can be skipped during playback. This feature is explained in detail on pages 21-22.

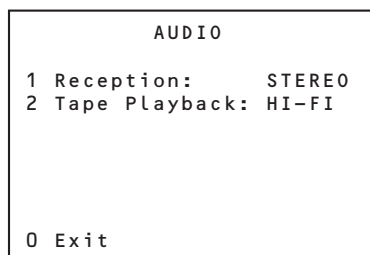

Audio

Your VCR's audio features can be customized and affect both tape playback and recordings. To access the *AUDIO* menu, press MENU on the remote (the *VCR MAIN MENU* appears), then press 7 (the *AUDIO* menu appears).

Reception

You can select the type of audio signal the VCR receives and records. Choose from *STEREO*, *MONO*, and *SAP*.

Press the 1 button repeatedly to choose the desired setting. *STEREO* is used for normal or stereo broadcast recording. *MONO* is used if the signal is weak or the sound is too noisy. *SAP* is used to record a Second Audio Program, such as a bilingual program.

Tape Playback

Tape Playback lets you select what type of audio that is played during playback. Choose from *HI-FI*, *LINEAR*, and *MIX*.

Press the 2 button repeatedly to choose the desired setting. *HI-FI* is used for normal playback. *LINEAR* is for mono sound, such as a Second Audio Program, or a dubbed voice-over. *MIX* is used to play back the sound recorded on both the Hi-Fi and linear tracks.

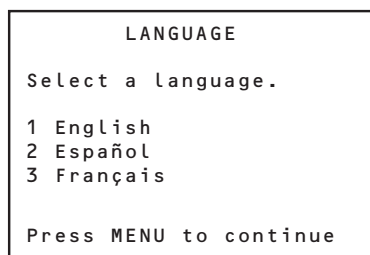

Language

Select your preferred language to determine how the on-screen displays will appear. The language setting is explained in detail on page 8.

Troubleshooting

In this section, you will find answers to common recording, playback, and general VCR questions. Consulting with this section first when there is problem may help you answer common questions.

General VCR Problems

No power

- Make sure the VCR is plugged into a working outlet.
- Make sure connections between devices are correct and snug.

The VCR does not respond to the remote control

- To put the remote control in VCR mode, press the VCR button first. The remote control should then operate the VCR.
- Make sure there are no objects between the VCR and the remote control.
- The remote might need new batteries.
- Remove the remote control's batteries and press the number 1 button for at least 60 seconds. Release the 1 button and replace the batteries. This resets the factory default settings, which may require reprogramming to operate other components.

The remote control no longer operates an RCA, GE, Proscan, or Scenium TV

- Press the TV button to put the remote control in TV mode. The remote control should then operate the TV.

There's poor quality or no picture for normal TV viewing

- If using RF coaxial cables to connect the VCR to the TV, make sure the VCR indicator is not displayed on the VCR's front panel. Press the TV•VCR button to toggle between VCR and TV-viewing modes.
If using A/V jacks and cables to connect the VCR to the TV (and the remote is compatible with your TV), press the remote control's INPUT button when in TV mode to access the TV's Video Input Channel.
- Tune the TV to an active channel.
- All cables should be securely inserted and connected to the proper jacks.

Cannot select channels over 69

- Cable channels over 69 can only be selected if *Signal Type: CABLE/ANTENNA* is set to *CABLE* in the *CHANNELS* menu. Go to page 28 for instructions.

The timer indicator flashes on the VCR front panel

- The clock is not set. Go to page 9 for instructions.
- Make sure there is a tape in the VCR when a timer recording is set.

Rewind does not operate

- Make sure the tape isn't already rewound.
- Make sure the tape isn't damaged or broken.

The incorrect time or date is shown

- A power interruption may have occurred and Automatic Clock Set was not turned on or did not work properly. Check the *Set Time Zone* and *Daylight-Saving* settings in the *TIME* menu.
- Make sure the VCR or cable box is tuned to the time data channel (check with your cable service provider for information about time data).
- Auto Clock Set is not supported in all areas or by digital satellite receivers. Set the time and date manually using the *TIME* menu. Go to page 9 for instructions.

The time did not adjust for Daylight-Saving Time

- Make sure the Daylight-Saving Time feature is set correctly in the *TIME* menu.

Chapter 5: Additional Information

The VCR makes noise when it is stopped

- This is normal. The VCR removes the tape from the playheads when stopping. The cylinders inside the VCR will continue to rotate for a few minutes after stopping.

The VCR won't find active channels correctly using the Auto Channel Search feature

- Make sure all cable connections are secure and correct.
- Make sure that *Signal Type: CABLE/ANTENNA*, is set correctly in the *CHANNELS* menu.
- If *Detect Automatically* was selected for the Signal Type in the *AUTO CHANNEL SEARCH* menu, try using either *CABLE TV* or *ANTENNA* instead.
- Auto Channel Search may not be necessary if using a cable box to view all channels. Contact your local cable company for more information.

On-screen menus appear in a foreign language

- Check the *LANGUAGE* menu to choose a preferred on-screen language.

Recording Problems

Will not record

- Make sure there is a recordable tape in the VCR.
- Eject then reinsert the tape.
- Make sure the tape is not broken.
- Make sure the VCR is not in pause mode. Press PAUSE or PLAY to return to normal playback.
- Make sure the Pro-Tect Plus feature is not active. Go to page 19 for instructions.
- Make sure the tape's safety tab is intact.

Timer recording was not made or the wrong program was recorded

- Make sure the program was entered correctly (the wrong channel or times may be entered).
- Make sure the cable box or satellite receiver was turned on when recording was to begin.
- There may have been a power interruption. Reset the time and date.
- Check to see if time and date are correct – including AM/PM.
- Make sure the program did not exceed the tape's length or that the tape was not rewound beforehand.
- Make sure the VCR was turned off at the time recording started.
- Make sure there was a tape in the VCR with its safety tab intact.
- The VCR ejects tapes when the end is reached during a timer recording.

Playback Problems

Snowy or no picture during playback

- Press the TV•VCR button to activate VCR mode. *VCR* appears in the front panel display when active.
- Check the TV channel selected (3 or 4) to make sure it matches the VCR channel output setting.
- Check to make sure the TV's fine tuning is correct for the channel selected.
- If you use A/V cables and jacks to connect the VCR to the TV, check all connections for snug and correct connections.
- If you are using A/V cables, make sure the TV is set to the Video Input Channel. Go to page 38 for instructions.
- If you are not using A/V cables, make sure the VCR is not in Video Input Channel mode. Press INPUT on the remote control to return to normal viewing.
- Try another tape.
- Some snow/streaks are normal during search, stop action, frame advance, and slow-motion playback.

Streaks in picture during normal playback

- Press one of the TRACKING buttons to move streaks up or down for the best picture.
- Make sure the tape is of good quality and not worn out.

Time counter not working or time counter not working in search modes

- The time counter does not advance during unrecorded portions of tape. When an unrecorded segment of tape is encountered, the time counter will hold its count until recorded material is detected again.
- A minus (–) will appear in front of the time if you rewind the tape farther back than a counter reading of 0:00:00.
- The time counter disappears during search; this is normal.

Tape won't play

- Make sure there is a tape in the VCR.
- Try ejecting and reinserting the cassette.
- Make sure the tape is not broken.
- Make sure the VCR is not in pause mode. Press PAUSE or PLAY to return to normal playback.
- Check the Pro-Tect Plus™ feature.

Auto Channel Search doesn't work

- Make sure the antenna connections are secure and correct.
- Make sure the Signal Type feature is set correctly.
- If *Detect Automatically* was selected for the signal type in the *AUTO CHANNEL SEARCH* menu, try using either *CABLE TV* or *ANTENNA* instead.
- May not be necessary if using a cable box for all channels. Contact your local cable company for more information.

Tape plays back in slow motion

- Press PLAY to return to normal playback.

Tape with safety tab removed doesn't start playing

- Make sure the AUTO PLAY ON/OFF feature is set to *ON*.

Time counter disappears during searching

- This is normal.

There is no stereo sound during playback

- Make sure the Tape Playback feature is set to *Hi-Fi* to hear stereo sound during playback.
- You must connect the VCR to the TV using A/V cables (not provided) to hear true stereo sound during playback. Go to page 5 for instructions.

The stereo Audio is too noisy

- The stereo signal is weak. Set the *Reception: STEREO/SAP/MONO* to *MONO*.
- Press either the TRACKING up or down button to minimize picture noise.

Chapter 5: Additional Information

Questions and Answers About **COMMERCIAL ▶▶ ADVANCE®**

Will commercials be scanned through only on playback of recordings?

Yes. The VCR rewinds and marks commercial segments after a recording is finished.

How fast does this feature scan through commercial breaks?

In SLP tape speed, a 3-minute commercial break is scanned through in approximately 8-12 seconds. In SP, it takes about 25-35 seconds.

Are commercials still recorded if I want to watch them?

Yes. The recorded program, including commercials, can be viewed by setting the Playback feature to *MANUAL*.

What if the VCR scans forward through part of my program?

Press **PLAY** or **STOP** while the tape is being automatically skipped. Rewind the tape back to a position before skipping started, then press **PLAY**. Automatic skipping will start again after the end of the commercial group is detected by the VCR.

Once a recording has been marked, does COMMERCIAL ADVANCE work each time the tape is played?

Yes. If the Playback feature is set to *AUTO*, the marked commercials should be skipped each time the tape is played in a VCR that has the feature.

After marking commercials, is the tape left at the beginning or end of the recording?

The tape is left at the end of the recording so it is in position to begin additional programmed recordings.

Does the marking process interfere with other programmed recordings?

No. If two or more recordings are programmed together without sufficient time to mark the first recording, marking will take place after all recordings are completed.

What happens if the marking process is interrupted?

Marking can be interrupted to allow use of the VCR. Marking will resume again when the VCR's power is turned off as long as the tape has not been ejected from the VCR.

Does COMMERCIAL ADVANCE work in all recording speeds?

Yes, the feature works in SP and SLP.

Will COMMERCIAL ADVANCE marked recordings work in non-Commercial Advance VCRs?

A marked recording will play in a VCR that does not have the feature, but commercials will not automatically be skipped.

Display Panel

Clock/Counter Displays current time, time counter, tape speed, or channel numbers when switching channels.

FUNCTION DISPLAYS:

BYE The VCR is turned off.

EJEC A tape is being ejected.

FF A tape is fast-forwarding.

HI The VCR is turned on.

PLAY A tape is in playback mode.

PLAY (Flashing) Playback is paused; a still-frame image is displayed.

REC The VCR is recording. Also denotes a timer recording in progress.

REC (Flashing) A recording is paused.

REW A tape is rewinding.

SAFE The Pro-Tect Plus™ locking feature is active.

SRCH The VCR is searching forward.

-SRCH The VCR is searching in reverse.

SLOW A tape is playing back in slow motion.

STOP A tape is in stop mode.

0:00, 0:30, 1:00, etc. An Express Recording is in progress.

HI-FI indicator Displays when the VCR is receiving stereo audio.

Tape In indicator (⏏) Displays when the VCR has a tape inserted.

TIMER indicator Displayed when an Express Recording (XPR) or timer recording is under way or when the VCR is set for a timer recording and the power is turned OFF. *TIMER* flashes on the VCR front panel when a timer recording is set and no tape is inserted in the VCR.

VCR indicator Indicates that the VCR is in VCR-display mode. Press the TV•VCR button to toggle between VCR and TV viewing modes.

- VCR indicator is ON when the picture displayed is from the VCR's tuner.
- VCR indicator is OFF when the picture displayed is from the TV's tuner.

Glossary

A/V jacks & cables Commonly called "RCA-type" cables. Improves picture and sound quality over RF coaxial cables. A/V cables are required for stereo audio. Right audio cables and corresponding jacks are usually color-coded red, left audio cables and jacks are white, and video cables and jacks are yellow.

Commercial Scan A feature that advances the tape 30 seconds of recorded material during playback. Each press advances the tape an additional 30 seconds up to five minutes.

EnergySaver Automatically turns the VCR off after a user-defined period of inactivity.

Express Recording (XPR) A method of timer recording which tapes for a set period of time using 30- or 60-minute increments.

Pro-Tect Plus™ Allows the VCR to be disabled so that the front panel and remote control buttons don't work. Useful for protecting timer recordings.

Initial Setup Guide The on-screen instructions that walk you through several steps the first time you turn on the VCR. The Initial Setup Guide is also available in the VCR's Main Menu.

SAP (Second Audio Program) A second sound track that may be included with a stereo broadcast. Usually used for foreign language dubs of programs.

VCR Channels List The active list of channels available to the VCR using the CHANNEL +/- buttons (CHAN up or down on the remote control).

XPR See Express Recording above.

Limited Warranty

What your warranty covers:

- Defects in materials or workmanship.

For how long after your purchase:

- 90 days - Unit exchange, with Thomson at no charge.
- 91 days to 1 year - Unit exchange, for a payment of \$29.95.

The warranty period for rental units begins with the first rental or 45 days from date of shipment to the rental firm, whichever comes first.

What we will do:

- **During the initial 90 days:**

Exchange your defective VCR with a new or, at our option, refurbished unit.

- **After the 90 days and within one year:**

Exchange your defective VCR with a new or, at our option, refurbished unit.

We will charge you a flat handling fee of \$29.95 to replace your defective VCR.

How to get service:

During the initial 90 days:

- Properly pack your unit. Include any cables, etc., which were originally provided with the product. We recommend using the original carton and packing materials.
- Proof of purchase in the form of a bill of sale or receipted invoice which is evidence that the product is within the warranty period must be included to obtain warranty service. For rental firms, proof of first rental is also required. The unit will be returned to you if you fail to include this information.
- Print your name and address and a description of the defect. Send via standard UPS or its equivalent to:
Thomson multimedia Inc.
Attn: VCR Warranty
11721 B Alameda Avenue
Socorro, Texas 79927
- Insure your shipment for loss or damage. Thomson accepts no liability in case of damage or loss en route to Thomson.
- Pay any charges billed to you by Thomson for service not covered by the warranty.
- A new or refurbished unit will be shipped to you freight prepaid.

After 90 days and within one year:

- Call 317-415-4909 and arrange to pay the \$29.95 handling fee. It can be paid by credit card (Discover, Visa, or MasterCard), certified check, or money order.
- Once payment has been arranged, you will be provided with a Service Request (SR) number. No returns will be accepted without the SR number.
- Properly pack your unit. Include any cables, etc., which were originally provided with the product. We recommend using the original carton and packing materials.
- Write the SR number on the outside of the carton used to return the unit.
- Proof of purchase in the form of a bill of sale or receipted invoice which is evidence that the product is within the warranty period must be included to obtain warranty service. For rental firms, proof of first rental is also required. The unit will be returned to you if you fail to include this information.
- Print your name and address and a description of the defect. Send via standard UPS or its equivalent to:
Thomson multimedia Inc.
Attn: VCR Warranty
11721 B Alameda Avenue
Socorro, Texas 79927
- Insure your shipment for loss or damage. Thomson accepts no liability in case of damage or loss en route to Thomson.
- Pay any charges billed to you by Thomson for service not covered by the warranty.
- A new or refurbished unit will be shipped to you freight prepaid.

What your warranty does not cover:

- Customer instruction. (Your Owner's Manual describes how to install, adjust, and operate your VCR. Any additional information should be obtained from your dealer.)
- Installation and setup service adjustments.
- Batteries.
- Cleaning of audio / video heads.
- Damage from misuse or neglect.
- Products which have been modified or incorporated into other products.
- Products purchased or serviced outside the U.S.A.
- Acts of nature, such as but not limited to lightning damage.

Product Registration:

- Please complete and mail the Product Registration Card packed with your unit. It will make it easier to contact you should it ever be necessary. The return of the card is not required for warranty coverage.

Limitation of Warranty:

- **THE WARRANTY STATED ABOVE IS THE ONLY WARRANTY APPLICABLE TO THIS PRODUCT. ALL OTHER WARRANTIES, EXPRESS OR IMPLIED (INCLUDING ALL IMPLIED WARRANTIES OF MERCHANTABILITY OR FITNESS FOR A PARTICULAR PURPOSE) ARE HEREBY DISCLAIMED. NO VERBAL OR WRITTEN INFORMATION GIVEN BY THOMSON MULTIMEDIA INC., ITS AGENTS OR EMPLOYEES SHALL CREATE A WARRANTY OR IN ANY WAY INCREASE THE SCOPE OF THIS WARRANTY.**
- **REPAIR OR REPLACEMENT AS PROVIDED UNDER THIS WARRANTY IS THE EXCLUSIVE REMEDY OF THE CONSUMER. THOMSON MULTIMEDIA INC. SHALL NOT BE LIABLE FOR INCIDENTAL OR CONSEQUENTIAL DAMAGES RESULTING FROM THE USE OF THIS PRODUCT OR ARISING OUT OF ANY BREACH OF ANY EXPRESS OR IMPLIED WARRANTY ON THIS PRODUCT. THIS DISCLAIMER OF WARRANTIES AND LIMITED WARRANTY ARE GOVERNED BY THE LAWS OF THE STATE OF INDIANA. EXCEPT TO THE EXTENT PROHIBITED BY APPLICABLE LAW, ANY IMPLIED WARRANTY OF MERCHANTABILITY OR FITNESS FOR A PARTICULAR PURPOSE ON THIS PRODUCT IS LIMITED TO THE APPLICABLE WARRANTY PERIOD SET FORTH ABOVE.**

How state law relates to this warranty:

- Some states do not allow the exclusion nor limitation of incidental or consequential damages, or limitations on how long an implied warranty lasts, so the above limitations or exclusions may not apply to you.
- This warranty gives you specific legal rights, and you also may have other rights that vary from state to state.

If you purchased your product outside the U.S.A:

- This warranty does not apply. Contact your dealer for warranty information.

How to Find Your TV's Video Input Channel

You must tune your TV to the video input channel if you are using the VCR's Audio/Video (A/V) OUT jacks to connect to the TV's A/V input jacks. You must select the TV's video input channel before you can see the VCR's menus, the cable/antenna reception, and the content that's on a tape.

The video input channel for TVs varies by brand and model. Below are some steps to try to find your TV's video input channel:

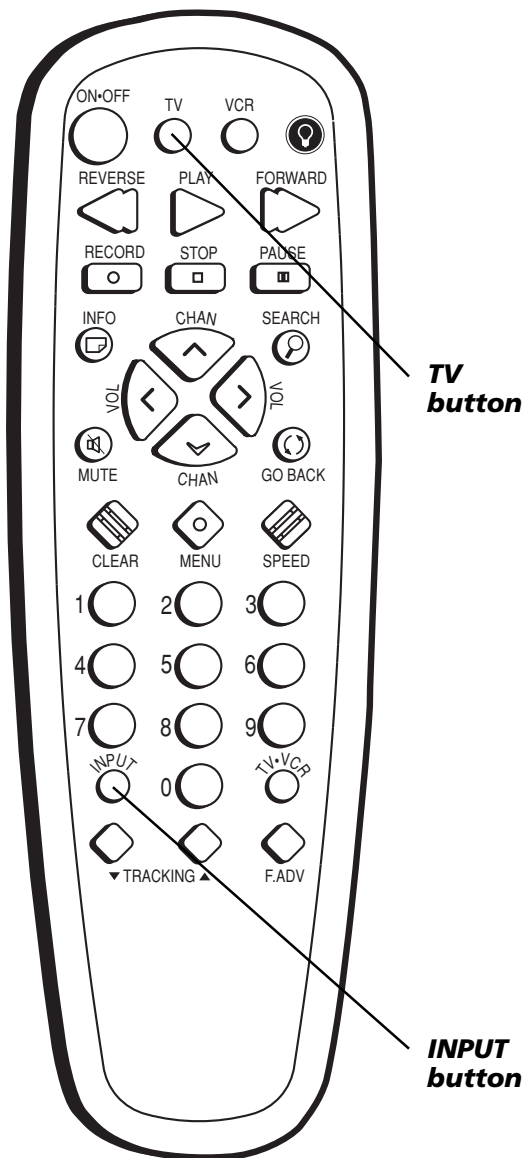

- If your TV brand is RCA, GE, Proscan, or Scenium, press the TV button on the VCR's remote control, then press the INPUT button.
- If you have another brand of TV, see page 13 to see if the VCR's remote can be programmed to control your TV. If so, once completed, follow the step above.

If those options do not work, try the following ideas. You might access the video input channel by:

- Pressing a button on the TV's remote control (see the table below).
- Selecting a specific channel from the TV's on-screen menu system (see the table below).
- Tuning directly to the video input channel by selecting a specific channel number (see the table below)
- Going through all available channels by pressing the channel up or down buttons on the TV or its remote control.

Video Input Channel Variations

Button/Switch on the TV	Button on the TV Remote	Channel Number
VIDEO	VID 1	00
SIGNAL	LINE	90
VID 1	VID	91
VID 2	VIDEO	92
S-VID	S-VID	93
S-VIDEO	INPUT	VID 1
	S-VIDEO	VID 2
	SOURCE	
	AUX	

Notes: If you programmed your remote control to operate your TV (instructions on page 13), and you are using audio/video jacks, press the INPUT button to find the Video Input Channel.

The remote control shown here has a backlight button and is included with the VR712HF only. The VR648HF remote doesn't have a backlight button.

This page left blank intentionally.

This page left blank intentionally.

Index

- A**
Audio 30
Audio/Video (A/V)
 jacks 9
Audio/video cables 4
Auto Channel Search 27
Auto Play 10, 29
Auto TV/VCR 29
Automatic rewind 10
- B**
Basic recording 10
BYE display 35
- C**
Cable box setup 9, 28
Cables
 Audio/Video 4
 coaxial 4
 positioning 3
CH + and - buttons 11
Channel buttons 27
Channels, adding/
 removing 28
CLEAR button 19
Clock display 35
Coaxial cable 4
COMMERCIAL ADVANCE
 Display 22
 Playback 22
 questions and
 answers 34
Commercial Scan 35
Connections 5
- D**
Display panel 35
Displays, on screen 20
- E**
EJECT button 10
EnergySaver feature 29
Express Recording
 (XPR) 17
- F**
F ADV button 11
FF display 35
FORWARD button 11
- Front Panel 29
FWD button 10, 20
- G**
Glossary 35
GO BACK button 11
- H**
HI display 35
Hi-Fi 30
Hi-Fi indicator 35
- I**
Index search 19
INFO button 11, 20
INPUT button 11, 38
- L**
Language 30
Limited warranty 36
Linear 30
Locking feature 19
- M**
MENU button 21
Mix 30
Modes, remote
 control 14
Mono 30
MOVIE ADVANCE 23
 overriding 23
MUTE button 11
- N**
Number buttons 11
- O**
ON•OFF button 19
Overheating 3
- P**
PAUSE button 10, 11
PLAY button 10, 11
PLAY display 35
POWER button 10
Power surges 3
Preferences 29
PREFERENCES menu 21
Pro-Tect Plus 19
Programming the Remote
 Direct Entry 13
- R**
REC display 35
Reception 30
RECORD
 button 10, 11, 17
Recording
 basic 10
 Express (XPR) 17
 speeds 30
 timer 18
Remote
 buttons 11
 component buttons 13
Remote Control 29
 Programming 13
 Programming Codes 15
Removing/adding
 channels 28
REV button 10
REVERSE button 11
Reviewing timer
 programs 18
REW display 35
Rewind, automatic 10
- S**
Safety tab 10, 29
SAP 30
SEARCH button 19
Set up
 cable box 9, 28
 tape speed feature 30
Setup 29
Signal type 28
SLOW display 35
Speed
 SLP 30
 SP 30
SPEED button 10, 17
Speeds, recording 30
SRCH displays 35
Stereo 30
STOP
 button 10, 11, 17, 19
STOP display 35
- T**
Tab, safety 10
Tape eject 10
Tape Playback 30
Tape speeds 30
Time 27
Time counter 20
Time counter display 20
Time display on TV 20
Timer programs
 clearing 18
 reviewing 18
Timer recording 18
 stopping 18
TRACKING buttons 11
Troubleshooting 31
TV button 11, 38
TV•VCR button 29
- U**
Universal remote
 programming to control
 other brands of
 components 14
- V**
VCR
 connecting 5
VCR indicator 35
VCR Output Channel 28
VCR viewing channel 10
Video Input Channel 38
VOL buttons 12
- W**
Warranty 36
- Z**
Zero search 19

Visit the RCA website at www.rca.com

Please do not send any products to the Indianapolis address listed in this manual or on the carton. This will only add delays in service for your product.

Thomson multimedia Inc.

10330 North Meridian Street

Indianapolis, IN 46290

©2002 Thomson multimedia Inc.

Trademark(s)® Registered

Marca(s) Registrada(s)

Printed in Indonesia

TOCOM 15887580



Free Manuals Download Website

<http://myh66.com>

<http://usermanuals.us>

<http://www.somanuals.com>

<http://www.4manuals.cc>

<http://www.manual-lib.com>

<http://www.404manual.com>

<http://www.luxmanual.com>

<http://aubethermostatmanual.com>

Golf course search by state

<http://golfingnear.com>

Email search by domain

<http://emailbydomain.com>

Auto manuals search

<http://auto.somanuals.com>

TV manuals search

<http://tv.somanuals.com>