

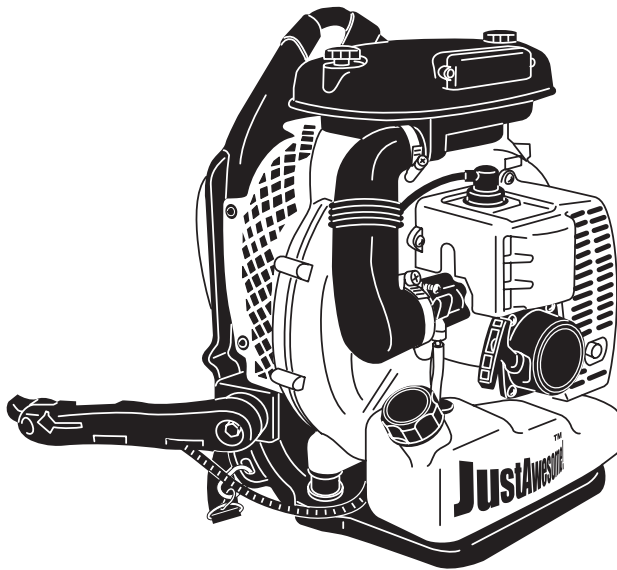

OWNER/OPERATOR MANUAL

BACKPACK BLOWER

EB7000



WARNING



The engine exhaust from this product contains chemicals known to the State of California to cause cancer, birth defects or other reproductive harm.

Thank you for purchasing a RedMax product.

Before using our blower, please read this manual carefully to understand the proper use of your unit.

APPLICABLE SERIAL NUMBERS :

010001 and up



Read this manual carefully to understand all safety precautions, controls, proper operation and maintenance of your RedMax blower. Failure to do so could result in serious injury.



SAFETY FIRST

Instructions contained in warnings within this manual and warning seals marked with a  symbol on the blower concern critical points which must be taken into consideration to prevent possible serious bodily injury, and for this reason you are requested to read all such instructions carefully and follow them without fail.

Note that there may be times when warning seals peel off or become soiled and impossible to read. If this happens, you should contact the dealer from which you purchased the product to order new seals and affix the new seal(s) in the required location(s).

■ Notes on types of warnings



Instructions labeled as shown at left, concern critical steps or procedures which must be followed in order to prevent accidents which could lead to serious bodily injury or death. This mark is used to indicate instructions which must be followed without exception.



Instructions labeled as shown at left concern steps or procedures which, if not followed correctly, could lead to mechanical failure, breakdown, or damage.



Used to label supplementary instructions designed to provide hints or directions useful in the use of the product.

CONTENTS

SAFETY PRECAUTIONS	4
OPERATOR	
USE OF BLOWER	
FUEL	
WORKING CONDITION	
AVOID NOISE PROBLEM	
AVOID CHANCES OF DAMAGE	
WARNING LABELS ON THE MACHINE	7
SYMBOLS ON THE MACHINE	8
PARTS LOCATION & SPECIFICATIONS	9
ASSEMBLY	9
BLOWER TUBE	
FUEL	10
HOW TO MIX FUEL	
FUELING THE UNIT	
OPERATION	11
CONTROL ARM	
STARTING ENGINE	
ADJUSTING IDLE SPEED	
STOPPING ENGINE	
MAINTENANCE	13
AIR CLEANER	
FUEL FILTER	
SPARK PLUG	
MUFFLER	
SPARK ARRESTER	
AIR INLET NET	
SHOULDER STRAP	
STORAGE	16
PARTS LIST	17



Safety Precautions

WARNING

- Read this Blower Owner/Operator Manual carefully. Be sure you understand how to operate this unit properly before you use it. Failure to do so could result in serious injury.



- Be sure to keep this manual handy so that you may refer to it later whenever any questions arise. Also note that you are requested to contact the dealer from whom you purchased the product for assistance the event that you have any questions which cannot be answered herein.
- Always be sure to include this manual when selling, lending, or otherwise transferring the ownership of this product.

OPERATOR

- Refrain from operating the blower if you are tired, ill, or upset, or if you are under the influence of alcohol, drugs or medication.



- To reduce the risk of hearing loss associated with sound level(s), hearing protection is required.
- Always wear eye protection and foot protection. Eye protection should meet the requirements of ANSI Z87.1.



- To reduce the risk of injury associated with the inhalation of dust, use a face filter mask in dusty conditions.
- Wear rubber-soled shoes or shoes with

some other form of anti-slip protection to help protect you against falling.

- To reduce the risk of injury associated with objects being drawn into rotating parts, do not wear loose clothing, scarves, neck chains, unconfined long hair, and the like.

USE OF BLOWER

- Each time before starting the engine, inspect the entire unit to see if every part is in good order and is securely tightened in place. If any damage is found in the fuel line, the exhaust line, or the ignition wiring, do not use the blower until it has been repaired.

IMPORTANT

- Before starting operation, always make sure to check if any obstacles are left inside the volute case. The obstacles may cause damage on fan and volute case and serious injury.

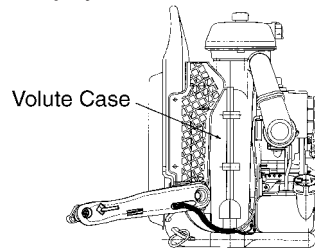

WARNING

Check to see if the shock-absorbing rubber mount has become cracked or otherwise damaged. **Note that failing to replace this rubber mount when it has become cracked or damaged may cause the engine to come loose from its frame during use, thus resulting in possible serious bodily injury.**

- If cracked, be sure to replace without delay.

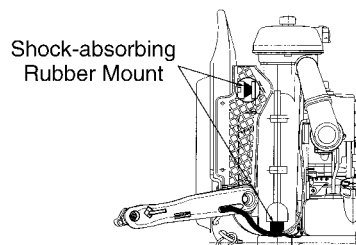



Safety Precautions

WARNING

- To reduce the risk of injury associated with contacting rotating parts, stop the engine before installing or removing attachments. **Do not operate without net in place.** Always disconnect the spark plug before performing maintenance or accessing movable parts.

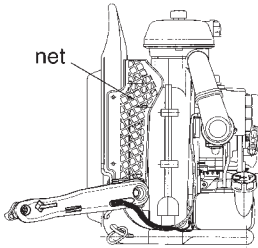

- Do not allow children to use blower. Make sure that each person you authorize to operate the blower understands all of the safety rules in this manual.
- Avoid using any accessory or attachment other than those bearing the RedMax mark for use with the blower.
- Drain the fuel from the fuel tank before transporting or storing the blower.
- When storing the blower, choose a space indoors free from moisture and out of the reach of children.
- Examine the blower at intervals for loose fasteners and rusted or damaged parts. Use special care **around the fuel line, the muffler, and the ignition wiring.**
- All engine service except for those described in this manual should be performed by competent service personnel. Improper service to the blower fan and muffler could cause a hazardous failure.

FUEL

WARNING

To reduce the risk of fire and burn injury:



- Handle fuel with care. It is highly flammable.
- Do not smoke while handling fuel.
- Do not refuel a hot engine.
- Do not refuel a running engine.
- Avoid spilling fuel or oil. Always wipe unit dry before using.
- Move at least 10 ft. (3 meters) away from the fueling point before starting engine.
- Always store gasoline in a container approved for flammable liquids.
- Make sure the unit is properly assembled and in good operating condition.

WORKING CONDITION

- Check the work area that the blower will be used in and remove or cover all valuables that may be damaged by the air blast or thrown debris.
- To reduce the risk of injury associated with exhaust fume inhalation, do not operate in unventilated area. The exhaust gases contain harmful carbon monoxide.

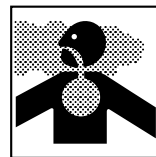

- Do not allow bystanders in work area.
- Do not point the blower nozzle in the direction of people or pets.

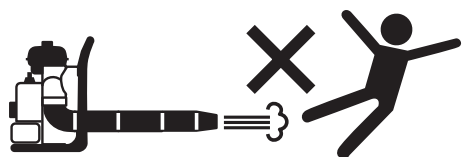



Safety Precautions

- Avoid using the blower where stable footing and balance are not assured.
- Never to touch the spark plug or plug cord while the engine is in operation. Doing so may result in being subjected to an electrical shock.



- Never to touch the muffler, spark plug, or other metallic parts of the engine while the engine is in operation or immediately after shutting down the engine. These metallic parts reach high temperatures during operation and doing so could result in serious burns.



■ AVOID NOISE PROBLEM

NOTE

Check and follow the local regulations as to sound level and hours of operations for blower.

- Operate power equipment only at reasonable hours-not early in the morning or late at night when people might be disturbed. Comply with times listed in local ordinances.
- To reduce sound levels, limit the number of pieces of equipment used at any one time.
- Operate power blowers at the lowest possible throttle speed to do the job.
- Check your equipment before operation, especially the muffler, air intakes and air filters.
- Loosen compacted leaves, grass or debris with a rake or broom beforehand, so that the lowest possible throttle setting would get the job done.
- In dusty conditions, slightly dampen surfaces or use mister attachment when water is available.

■ AVOID CHANCES OF DAMAGE

- Watch out for children, pets, open windows or freshly washed cars, and blow debris safely away.
- Use the full blower nozzle extension so the air stream can work close to the ground.
- After using blowers and other equipment, CLEAN UP! Dispose of debris in trash receptacles.
- Always check to be sure that no debris has been blown onto someone else's property.

Warning labels on the machine

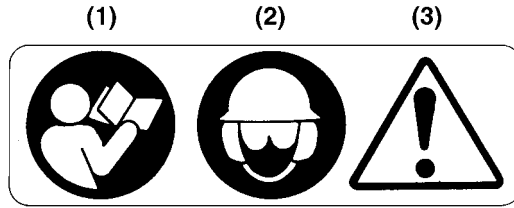

- (1) Read owner's manual before operating this machine.**
- (2) Wear head, eye and ear protection.**
- (3) Handling this machine improperly could result in accidents causing serious injury or death. Read this manual carefully and practice using the blower until you are fully acquainted with all operations and have learned to use it correctly.**

IMPORTANT

If warning label peel off or become soiled and impossible to read, you should contact the dealer from which you purchased the product to order new labels and affix them in the required location(s).

⚠ WARNING

Never modify your machine.

We won't warrant the machine, if you use the remodeled machine or you don't observe the proper usage written in the manual.

Symbols on the machine

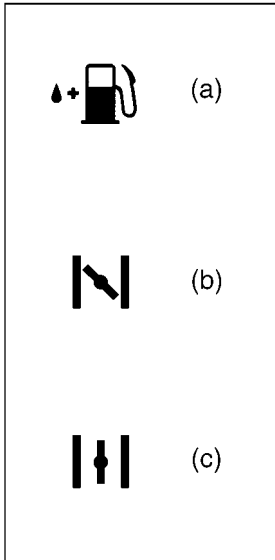

For safe operation and maintenance, symbols are carved in relief on the machine. According to these indications, please be careful not to take a mistake.

(a) The port to refuel the "MIX GASOLINE"

Position: FUEL TANK CAP

(b) The direction to close the choke

Position: AIR CLEANER COVER

(c) The direction to open the choke

Position: AIR CLEANER COVER

IMPORTANT ENGINE INFORMATION

THIS ENGINE CONFORMS TO US EPA PH1 AND 1995-1998 CALIFORNIA EMISSION REGULATIONS FOR ULGE ENGINES.
ENGINE FAMILY : TKZ062UB25RA;EM
ENGINE DISPLACEMENT : 62.0cc
REFER TO OWNER'S MANUAL FOR MAINTENANCE SPECIFICATIONS AND ADJUSTMENTS.



KOMATSU ZENOAH CO.
RedMax Made in Japan

INFORMATION IMPORTANTE CONCERNANT LE MOTEUR

Ce moteur conformc aux normcs U.S. EPA PH1 et 1995-1998 de la réglementation concernant la pollution de l'air pour les petits moteurs tout-terrain.
Type de moteur : TKZ062UB25RA;EM
Cylindrée du moteur : 62,0 cc
Se référer au Manuel de l'utilisateur pour les spécifications d'entretien et les réglages.



KOMATSU ZENOAH CO.
RedMax Made in Japan

Parts Location & Specifications

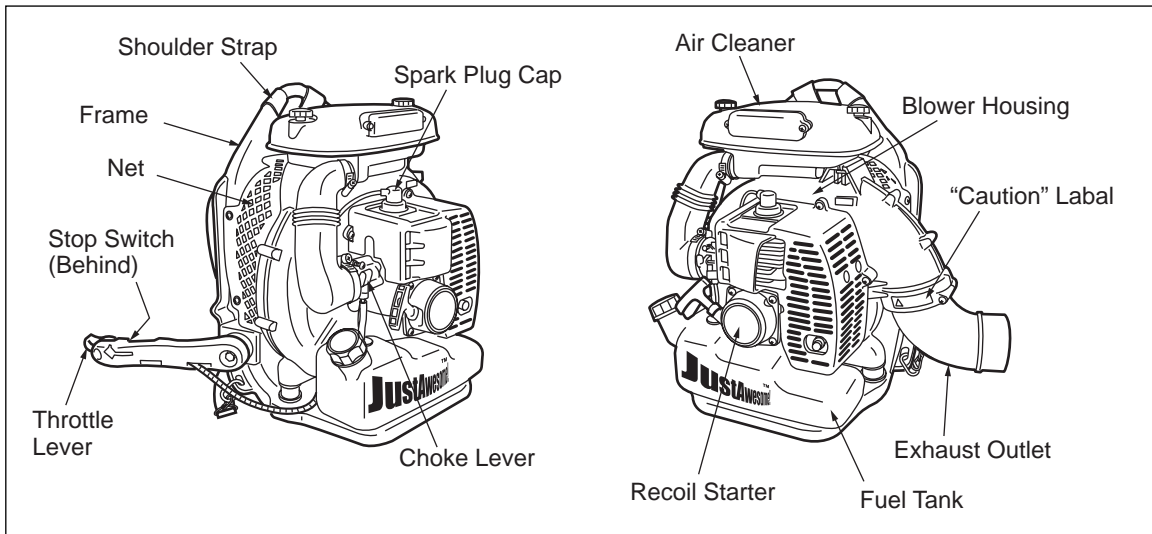

MODEL EB7000

Dimensions (L x W x H)	mm (in)	520 x 580 x 490 (205 x 228 x 193)
Dry Weight	kg (lbs)	9.6 (21.1)
Fuel Tank Capacity	liter (fl. oz)	2.1 (70.9)
Engine Type		Air cooled 2-cycle gasoline engine
Piston Displacement	cc (cu. in)	62 (3.78)
Air Filter		2-Stage Fresh Flow Filter System
Carburetor (Diaphragm)	valve type	Rotary
Ignition System		C.D.I
Spark Plug		Champion RCJ6Y (Noise-proof)
Muffler		Spark arrester equipped
Operating Engine Speed	rpm	2000 to 7500
Fuel Consumption	liter/h (fl. oz/h)	2.2 (65)
Max. Air Volume (w/ std Pipe)	cu. m/min (cfm)	15 (529)
Max. Air Volume (w/o Pipe)	cu. m/min (cfm)	20 (730)
Max. Air Velocity	m/sec (mph)	90 (200)
Durability Period For Emission Regulation	hrs	300
Noise Level (50 Feet Par ANSI B175-2)	dB(A)	73

Assembly

■ BLOWER TUBES

1. Connect the blower and swivel joint with flexible hose. Clamp both ends of the flexible hose securely with the hardware supplied with the unit.
2. Align the protrusion and the groove provided on the tube ends and twist the tube until connection is locked up.

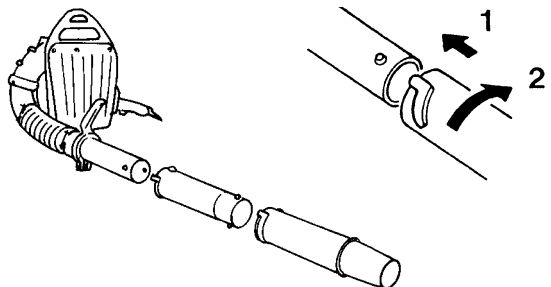

Fuel

⚠ WARNING

- **Gasoline is very flammable. Avoid smoking or bringing any flame or sparks near fuel. Make sure to stop the engine and allow it cool before refueling the unit. Select outdoor bare ground for fueling and move at least 3m(10ft) away from the fueling point before starting the engine.**



- The RedMax engines are lubricated by oil specially formulated for air-cooled 2-cycle gasoline engine use. If RedMax oil is not available, use an anti-oxidant added quality oil expressly labeled for air-cooled 2-cycle engine use. (JASO FC GRADE OIL or ISO EGC GRADE)

RECOMMENDED MIXING RATIO GASOLINE 50:OIL 1

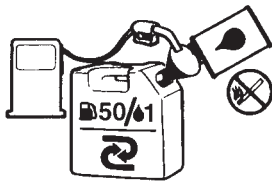

50:1 MIXING CHART

GASOLINE	gal.	1	2	3	4	5
2-CYCLE OIL	fl.oz	2.6	5.2	7.8	10.4	13

GASOLINE	liter	1	2	3	4	5
2-CYCLE OIL	ml	20	40	60	80	100

- **Exhaust emission are controlled by the fundamental engine parameters and components(eq., carburation, ignition timing and port timing) without addition of any major hardware or the introduction of an inert material during combustion.**
- These engines are certified to operate on unleaded gasoline.
- Make sure to use gasoline with a minimum octane number of 90 ROZ(USA/Canada : pump octane min.87)

- Unleaded gasoline is recommended to reduce the contamination of the air for the sake of your health and the environment.
- Poor quality gasolines or oils may damage sealing rings, fuel lines or fuel tank of the engine.

■ HOW TO MIX FUEL

1. Measure out the quantities of gasoline and oil to be mixed.
2. Put some of the gasoline into a clean, approved fuel container.
3. Pour in all of the oil and agitate well.
4. Pour in the rest of gasoline and agitate again for at least one minute.
5. Put a clear indication on the outside of the container to avoid mixing up with gasoline or other containers.
6. Indicate the contents on outside of container for easy identification.

■ FUELING THE UNIT

1. Untwist and remove the fuel cap. Rest the cap on a dustless place.
2. Put fuel into the fuel tank to 80% of the full capacity.
3. Fasten the fuel cap securely and wipe up any fuel spillage around the unit.

⚠ WARNING

1. Select bare ground for fueling.
2. Move at least 10 feet (3 meters) away from the fueling point before starting the engine.
3. Stop the engine before refueling the unit.

FOR YOUR ENGINE LIFE, AVOID;

1. **FUEL WITH NO OIL(RAW GASOLINE)** – It will cause severe damage to the internal engine parts very quickly.
2. **GASOHOL** – It can cause deterioration of rubber and/or plastic parts and disruption of engine lubrication.
3. **OIL FOR 4-CYCLE ENGINE USE or WATER COOLED 2-CYCLE ENGINE USE** – It can cause spark plug fouling, exhaust port blocking, or piston ring sticking.
4. **Mixed fuels which have been left unused for a period of one month or more** may clog the carburetor and result in the engine failing to operate properly.

Operation

■ CONTROL ARM

1. Hold the upper end of the control arm in hand and, while pulling it away from the unit, rotate arm forward (anti-clockwise as the arrow direction) until it clicks. (The first position)

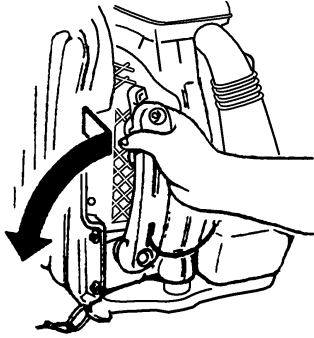

And if you want, you can rotate arm more forward until it clicks. (The second position)
Choose the arm position according to your working condition.

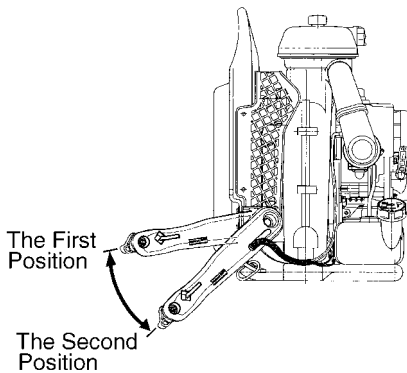

To fold the arm, reverse the order.

■ STARTING ENGINE

IMPORTANT

- **Avoid operating the blower with the flexible tube and swivel joint disconnected. That will reduce the cooling air and the engine could be damaged by overheating.**

1. Push the primer bulb until fuel flows out in the clear tube.
2. When the engine is cool, close the choke.

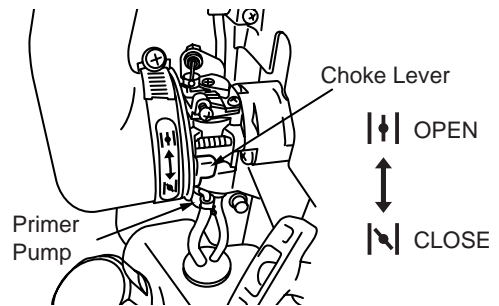

3. Set the throttle lever in 1/3 open position.

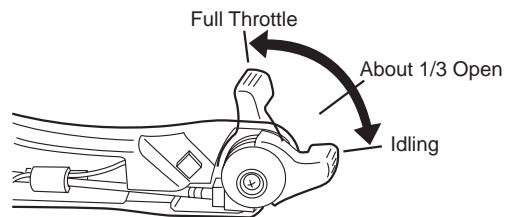

4. To start, hold the top of the blower firmly with your left hand. Pull the starter knob slowly until you feel it engage and then give it a vigorous strong pull.

IMPORTANT

- **Avoid pulling the starter rope out to its full extent and allowing the starter rope to snap back. This will prevent premature damage to the starter.**
- **Do not let a person stand near the blower or the exhaust port.**

5. Once the engine is running, gradually open

Operation

the choke if it was set closed, and let the engine run at idle speed for a minute to warm it up.

NOTE

- When the engine fails to start after several attempts due to overchoking, open the choke and repeat pulling the rope.

■ ADJUSTING IDLE SPEED

- The idling speed is set for 2000 rpm at the factory. If it is necessary to adjust the idle speed, use the adjustment screw on the top side of carburetor.

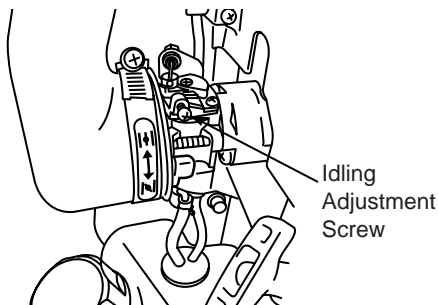

■ STOPPING ENGINE

- Move the throttle lever to the idling position and press the stop switch (red button) until the engine comes to a complete stop.

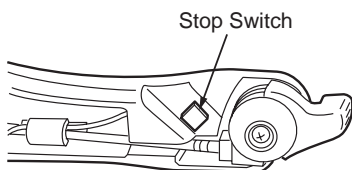

Maintenance

⚠ WARNING

- **Make sure that the engine has stopped and is cool before performing any service to the blower. Contact with rotating blower fan or hot muffler may result in a personal injury.**

■ AIR CLEANER

- Check the air cleaner every once week of use or more frequently if used under dusty conditions. A clogged air filter may increase fuel consumption while cutting down the engine power. Never operate the blower without the air filter or with a deformed filter element because unfiltered dusty air will quickly ruin the engine.

CLEANING AIR FILTER:

1. Unscrew 2 knob bolts and remove the air cleaner cover. Then remove a prefilter mounted inside the air cleaner cover.

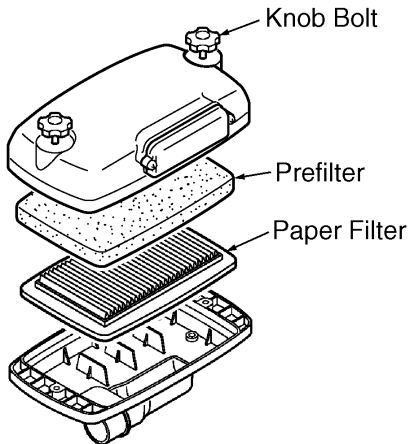

2. Wash the prefilter in fresh, non flammable cleaning solution (ex. warm soapy water) and then dry.
(※ Clean the air filter once in a week.)
3. Exchange the paper filter element with new one in case it has been contaminated.

■ FUEL FILTER

- A clogged fuel filter may cause poor acceleration of the engine. Check periodically to see if the filter is clogged with dirt. The filter can be taken out of the fueling port using a small wire hook. Disconnect the filter assembly from the fuel pipe and unhook the retainer to disassemble it. Clean the components with gasoline.

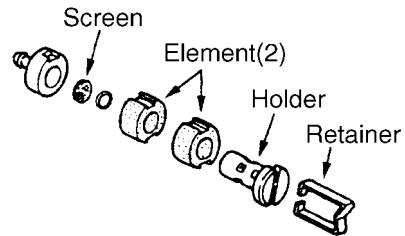

■ SPARK PLUG

- The spark plug may gather carbon deposits on its firing end with reasonable use. Remove and inspect the spark plug every 25 hours and clean the electrodes as necessary with a wire brush. The spark gap should be adjusted to .025 in (0.6~0.7mm).

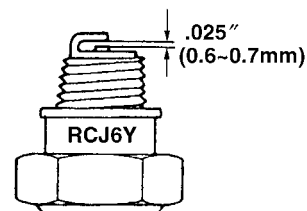

- Plug manufacturers recommend replacing the plug twice a year to avoid unexpected plug failure in a job.

REPLACEMENT PLUG IS A CHAMPION RCJ6Y.

IMPORTANT

- Note that using any spark plugs other than those designated may result in the engine failing to operate properly or in the engine becoming overheated and damaged.
- To install the spark plug, first turn the plug until it is finger tight, then tighten it a quarter turn more with a socket wrench.

Maintenance

■ MUFFLER

▲ WARNING

- Inspect periodically, the muffler for loose fasteners, any damage or corrosion. If any sign of exhaust leakage is found, do not use the blower and have it repaired immediately.
- **Note that failing to do so may result in the engine catching on fire.**

IMPORTANT

- Before starting operation, always make sure to check if the muffler is properly held by three bolts to the cylinder. (Fastening Torque : 80~120kg·cm)
- Even if one bolt out of three bolts is loose, the muffler may get loose during operation which may result in engine catching on fire.

■ SPARK ARRESTER

- The muffler is equipped with a spark arrester to prevent red hot carbon from flying out of the exhaust outlet. Periodically inspect and clean as necessary with a wire brush. In the State of California it is required by law (Section 4442 of the California Public Resources Code) to equip a spark arrester when a gas powered tool is used in any forest covered, brush covered, or grass covered unimproved land.

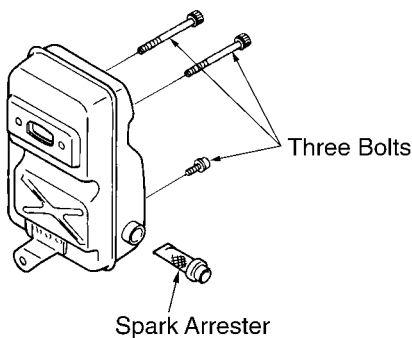

■ AIR INLET NET

IMPORTANT

- Blowing air is taken in from the air inlet net. When air flow has dropped down during operation, stop the engine and inspect the air inlet net for blocking by obstacles.
- Note that failure to remove any such obstacles may result in the engine becoming overheated and damaged.

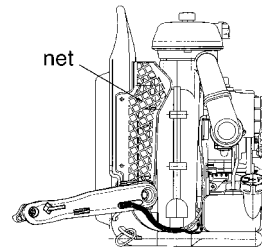

▲ WARNING

- **Never use the blower without the net of the blower. Before each use, check that the net is attached in place and is free from any damage.**

Maintenance

■ SHOULDER STRAP

- If the shoulder strap is damaged it may break during use, thus causing the product to fall and resulting in personal injury. Follow the instructions below to replace the shoulder strap.
- Pass the upper end of the strap through the hanger, making the FLAPPED SIDE OUTSIDE.
- Put the end of the strap through the ring on the strap, and then push the ring toward the hanger as close as possible.

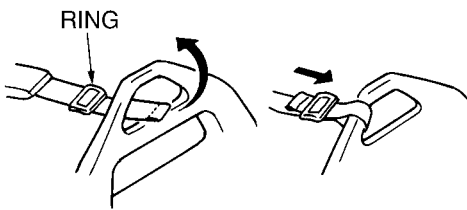

⚠ WARNING

- **The flap on the end of the strap works as a stopper. Never install the strap with the flapped side inside, or the unit may fall from the operator, which could result in injury to the operator and/or damage to the unit.**

Storage

BEFORE STORING THE BLOWER:

1. Drain a fuel tank and push the primer bulb until it becomes empty of fuel.
2. Remove the spark plug and drop a spoonful of 2-cycle oil into the cylinder. Crank the engine several times and replace the plug.

BACKPACK BLOWER

EB7000

NOTE :

1. Use KOMATSU ZENOAH genuine parts as specified in the parts list for repair and/or replacement.
2. KOMATSU ZENOAH does not warrant the machines, which have been damaged by the use of any parts other than those specified by the company.
3. When placing parts orders for repair and/or replacement, check if the model name and the serial number are applicable to those specified in the parts list, then use parts number described in the parts list.
4. The contents described in the parts list may change due to improvement.
5. The parts for the machine shall be supplied seven (7) years after the machine is discontinued. [It is possible that some specific parts may be subject to change of their delivery term and list price within the limit of ten (7) years after the machine is discontinued. It is also possible that some parts may be available even after the limit of seven (7) years.]

APPLICABLE SERIAL NUMBERS : 010001 and up

Fig.1 BLOWER GROUP (S/N 010001 and up)

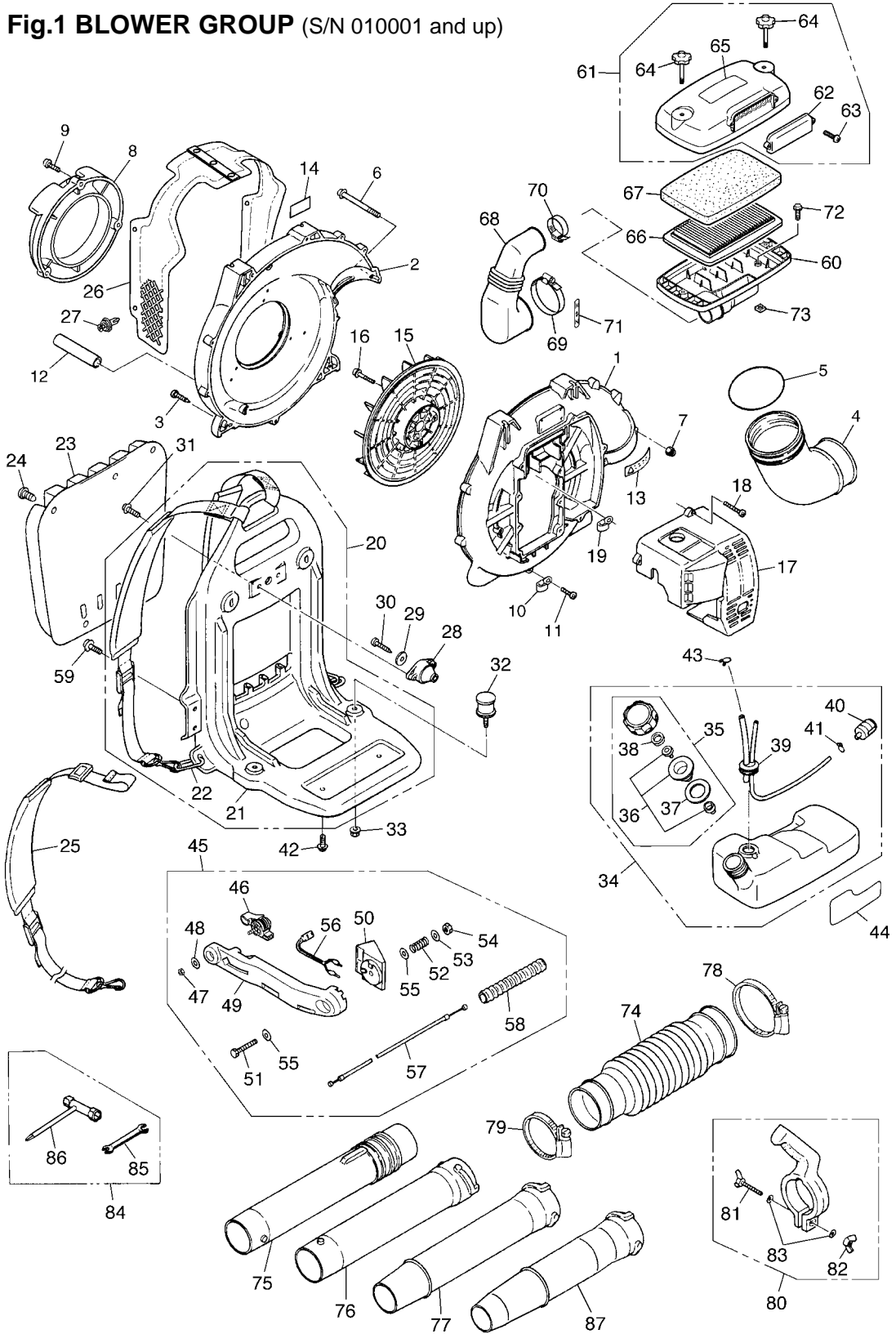

EB7000

Fig.1 BLOWER GROUP (S/N 010001 and up)

Key#	Part Number	Description	Q'ty	Key#	Part Number	Description	Q'ty
1	2750-31111	VOLUTE CASE	1	51	3495-25410	• BOLT	1
2	2750-31211	VOLUTE COVER	1	52	3495-25420	• SPRING	1
3	2750-31150	SCREW M5x25	9	53	3495-25440	• WASHER	1
4	3490-11150	ELBOW	1	54	01584-00605	• NUT	1
5	07000-02095	O-RING	1	55	3495-25450	• WASHER	2
6	2750-31420	SCREW M5x70	2	56	T4012-25510	• SWITCH	1
7	3310-53331	NUT	2	57	T4012-83110	• CABLE COMP	1
8	T4012-31310	COVER INLET	1	58	4900-72141	• TUBE	1
9	2750-31150	SCREW M5x25	3	59	2750-32540	BOLT	2
10	1140-72231	CLAMP	1	60	T4012-82110	BODY, cleaner	1
11	3407-16120	SCREW M5x14	1	61	T4012-82200	COVER ASSY	1
12	2750-31290	TUBE	1	62	T4012-82220	• COVER	1
13	2750-31911	LABEL	1	63	2750-31150	• SCREW	2
14	T4012-32610	LABEL, net	1	64	T4012-82800	• KNOB BOLT	2
15	2750-31510	FAN	1	65	T4012-82290	• LABEL, cleaner	1
16	3407-12210	BOLT M5x40	4	66	T4012-82310	ELEMENT	1
17	2750-31612	ENGINE COVER	1	67	T4012-82320	ELEMENT	1
18	2750-31150	SCREW M5x25	4	68	T4012-82610	HOSE	1
19	2750-72230	CLAMP	1	69	T4012-82620	BAND (φ 68)	1
20	T4012-32000	FRAME ASSY	1	70	T4012-82630	BAND (φ 40)	1
21	T4012-32100	• FRAME COMP	1	71	T4012-82640	LABEL, choke	1
22	3490-21120	• RING	2	72	00263-20520	SCREW	4
23	3460-21311	PAD	1	73	T4012-82710	NUT	4
24	3495-21320	CLIP	4	74	2750-51110	HOSE	1
25	2756-32300	BAND ASSY	2	75	2750-51200	SWIVEL JOINT	1
26	T4012-32500	NET COMP	1	76	6811-51210	PIPE, straight	1
27	1480-74710	CLIP	4	77	6811-51220	PIPE, END φ 66	1
28	2750-32510	DAMPER,UPPER	1	78	2756-51510	CLAMP	1
29	2750-32520	WASHER	1	79	2756-51520	CLAMP	1
30	2750-32530	SCREW M5x40	1	80	2750-51500	GRIP ASSY	1
31	2750-32540	BOLT M5x16 (Large Washer)	2	81	3495-51420	• WING BOLT	1
32	2750-32610	DAMPER,LOWER	2	82	3495-51430	• WING NUT	1
33	2750-32620	NUT M6	2	83	3238-15230	• WASHER	2
34	T4012-85100	TANK ASSY	1	84	2750-91000	TOOL SET	1
35	4500-85200	• CAP ASSY	1	85	3540-91120	• SPANNER	1
36	4500-85300	•• HOLDER ASSY	1	86	2750-91130	• SOCKET	1
37	4500-85220	•• PACKING	1	87	2756-51220	PIPE, end φ 57	OP
38	5601-85260	•• FILTER	1				
39	T4012-85300	• PIPE COMP	1				
40	3302-85400	• FILTER	1				
41	1260-85460	• CLIP	1				
42	3407-23610	SCREW	2				
43	1100-86120	CLIP	1				
44	T4012-85190	LABEL	1				
45	T4012-25000	LEVER SET	1				
46	T4012-25100	• LEVER	1				
47	3310-53331	• NUT M5	1				
48	01642-20508	• WASHER	1				
49	T4012-25210	• ARM	1				
50	T4012-25310	• BRACKET	1				

Parts List : EB7000

Fig.2 ENGINE GROUP (S/N 010001 and up)

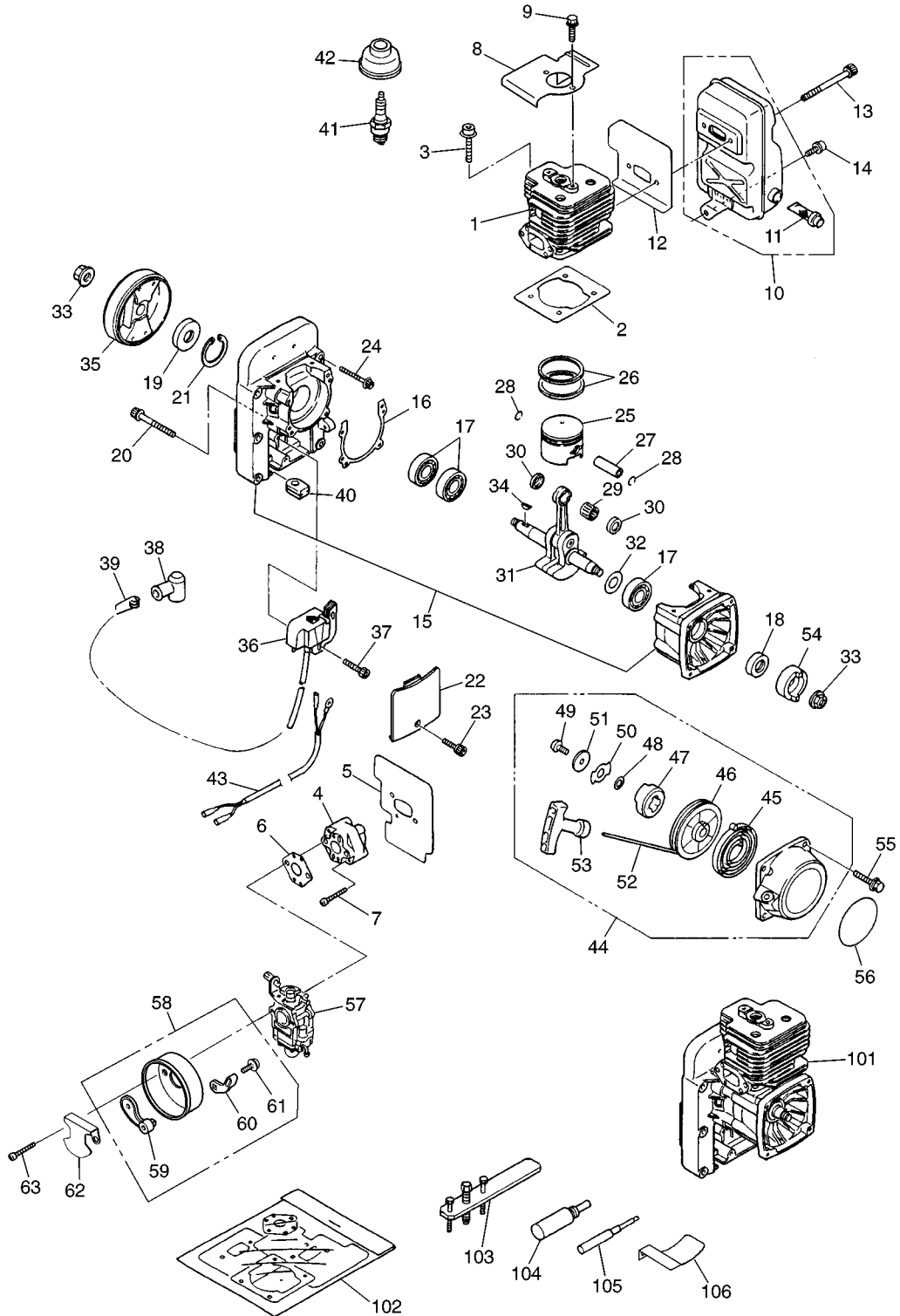

EB7000

Fig.2 ENGINE GROUP (S/N 010001 and up)

Key#	Part Number	Description	Q'ty	Key#	Part Number	Description	Q'ty
1	2750-12110	CYLINDER	1	47	1487-75140	• DOG	1
2	2750-12210	GASKET, base	1	48	1861-75150	• WASHER	1
3	1850-12130	BOLT	4	49	1483-75270	• SCREW	1
4	1484-13160	INSULATOR	1	50	1487-75160	• RETAINER	1
5	2750-13130	GASKET	1	51	1487-75170	• WASHER	1
6	1460-13132	GASKET	1	52	1400-75160	• ROPE	1
7	0263-90535	SCREW	2	53	1400-75170	• KNOB	1
8	2750-12510	COVER	1	54	1487-75211	PULLEY	1
9	2750-12520	BOLT	2	55	3460-75510	BOLT	4
10	2756-15100	MUFFLER ASS'Y	1	56	T4012-75610	LABEL	1
11	1421-15120	• ARRESTER	1	57	T4012-81000	CARBURETOR	1
12	2750-15210	GASKET	1	58	T4012-82400	CASE ASS'Y	1
13	2750-15160	BOLT	2	59	T4012-82420	• PLATE	1
14	2750-15170	BOLT	1	60	T4012-82430	• LEVER	1
15	2750-21100	CRANKCASE COMP	1	61	T4012-82440	• SCREW	1
16	2750-21140	GASKET	1	62	T4012-82510	PLATE	1
17	2810-21240	BEARING	3	63	0263-90550	SCREW	2
18	1520-21220	OIL SEAL	1				
19	1400-21220	OIL SEAL	1				
20	01252-30530	BOLT	4	101	2750-05010	SHORT BLOCK	OP
21	04065-03515	SNAP RING	1	102	2750-06010	GASKET KIT	OP
22	2750-21210	COVER	1	103	2750-96100	PULLER ASS'Y	OP
23	1565-72211	BOLT	1	104	3350-96220	STOPPER	OP
24	2750-21510	BOLT	4	105	3356-96230	GUIDE	OP
25	2750-41110	PISTON	1	106	2750-96240	GAUGE	OP
26	3366-41210	RING	2				
27	3366-41310	PISTON PIN	1				
28	3350-41320	SNAP RING	2				
29	1400-41410	BEARING	1				
30	2616-41510	WASHER	2				
31	2750-42000	CRANKSHAFT COMP	1				
32	1300-42410	SHIM	0~1				
33	1400-43230	NUT	2				
34	1000-43240	KEY	1				
35	2750-71110	ROTOR	1				
36	2750-71200	COIL ASS'Y	1				
37	3350-14150	BOLT	2				
38	1900-72112	CAP	1				
39	1900-72120	SPRING	1				
40	5500-72130	GROMMET	1				
41	5602-73110	SPARK PLUG (RCJ6Y)	1				
42	2751-71220	CAP	1				
43	2750-73200	CORD COMP	1				
44	1487-75100	RECOIL ASS'Y	1				
45	1180-75221	• SPRING	1				
46	1487-75120	• REEL	1				

Parts List : EB7000

Fig.3 CARBURETOR COMPONENTS (S/N 010001 and up)

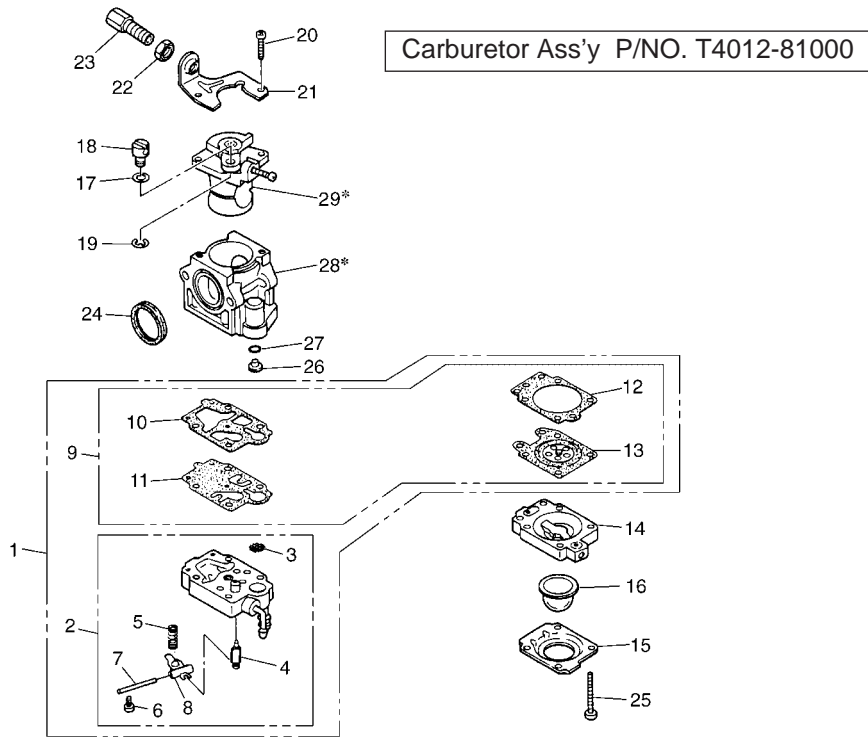

Fig.3 CARBURETOR COMPONENTS (S/N 010001 and up)

Key#	Part Number	Description	Q'ty	Key#	Part Number	Description	Q'ty
1	5602-06030	REBUILT KIT	1	21	5500-81120	BRACKET	1
2	1850-81450	• BODY ASS'Y	1	22	1751-81180	NUT	1
3	_____	•• SCREEN	1	23	1918-81170	SCREW	1
4	_____	•• VALVE	1	24	1881-81130	RING	1
5	_____	•• SPRING	1	25	1850-81530	SCREW	4
6	_____	•• SCREW	1	26	T4012-81250	JET	1
7	_____	•• PIN	1	27	1751-81240	O-RING	1
8	_____	•• LEVER	1	28*	_____	BODY	1
9	5602-06020	• GASKET KIT		29*	_____	VALVE ASS'Y	1
10	_____	•• GASKET	1				
11	_____	•• DIAPHRAGM	1				
12	_____	•• GASKET	1				
13	_____	•• DIAPHRAGM	1				
14	1850-81490	BODY	1				
15	1850-81520	COVER	1				
16	1751-81510	PUMP	1				
17	5500-81160	WASHER	1				
18	1881-81140	SWIVEL	1				
19	1751-81130	RING	1				
20	1752-81110	SCREW	2				

[NOTE]

• 28*-Body and 29*-Valve ass'y are not supplied as an individual part respectively, but supplied as a carburetor ass'y (P/NO. T4012-81000).

CALIFORNIA EMISSION CONTROL WARRANTY STATEMENT
YOUR WARRANTY RIGHTS AND OBLIGATIONS

The California Air Resources Board and KOMATSU ZENOAH are pleased to explain the **emission control system warranty** on your **1995 and later** small off-road engine. In California, new small off-road engines must be designed, built and equipped to meet the state's stringent anti-smog standards. KOMATSU ZENOAH must warrant the emission control system on your small off-road engine for the periods of time listed below provided there has been no abuse, neglect or improper maintenance of your small off-road engine.

Your emission control system may include parts such as the carburetor and the ignition system.

Where a warrantable condition exists, KOMATSU ZENOAH will repair your small off-road engine at no cost to you including diagnosis, parts and labor.

Manufacturer's warranty coverage:

The 1995 and later small off-road engines are warranted for **two years**. If any emission-related part on your engine is defective, the part will be repaired or replaced by KOMATSU ZENOAH.

Owner's warranty responsibilities:

– As the small off-road engine owner, you are responsible for the performance of the **required maintenance listed in your owner's manual**. KOMATSU ZENOAH recommends that you retain all receipts covering maintenance on your small off-road engine, but KOMATSU ZENOAH can not deny warranty solely for the lack of receipts or for your failure to ensure the performance of all scheduled maintenance.

– As the small off-road engine owner, you should be aware, however, that KOMATSU ZENOAH may deny you warranty coverage if your small off-road engine or a part has failed due to abuse, neglect, improper maintenance or unapproved modification.

– You are responsible for presenting your small off-road engine to a KOMATSU ZENOAH distribution center as soon as a problem exists. The warranty repairs should be completed in a reasonable amount of time, not to exceed **30 days**.

If you have any questions regarding your warranty rights and responsibilities, you should contact KOMATSU ZENOAH AMERICA INC. at (770)-381-5147 or you can write to

KOMATSU ZENOAH AMERICA INC.
4344 Shackleford Road Suite 500
Norcross, Georgia 30093

**Red Max BLOWERS
MODEL EB7000
2-YEAR LIMITED WARRANTY**

EMISSION-RELATED PARTS, FOR TWO (2) YEARS FROM THE DATE OF ORIGINAL DELIVERY OF THE MODEL EB7000, UNIT, KOMATSU ZENOAH AMERICA INC. (THE COMPANY), THROUGH ANY RedMax DEALER, WILL REPAIR OR REPLACE, FREE OF CHARGE, FOR THE ORIGINAL AND EACH SUBSEQUENT PURCHASER, ANY PART OR PARTS FOUND TO BE DEFECTIVE IN MATERIAL AND/OR WORKMANSHIP. EMISSION-RELATED PARTS ARE:

**THE CARBURETOR ASSY, COIL ASSY, ROTOR, SPARKPLUG,
AIR FILTER, FUEL FILTER, INTAKE MANIFOLD, AND THE GASKETS**

ALL OTHER PARTS EXCEPT ABOVE PARTS, FOR TWO (2) YEARS OF HOME USE [ONE (1) YEAR FOR ANY OTHER USE] FROM THE DATE OF ORIGINAL ANY DELIVERY OF THE MODEL EB7000 UNIT, THE COMPANY, THROUGH ANY RedMax DEALER, WILL REPAIR OR REPLACE, FREE OF CHARGE, FOR THE ORIGINAL PURCHASER, ANY PART OF PARTS FOUND TO BE DEFECTIVE IN MATERIAL AND/OR WORKMANSHIP. **THIS IS THE EXCLUSIVE REMEDY.**

THE PURCHASER SHALL BEAR COSTS OF TRANSPORTING THE UNIT TO AND FROM THE RedMax DEALER.

THE PURCHASER SHALL NOT BE CHARGED FOR DIAGNOSTIC LABOR WHICH LEADS TO THE DETERMINATION THAT A WARRANTED PART IS DEFECTIVE, IF THE DIAGNOSTIC WORK IS PERFORMED AT THE RedMax DEALER.

THE PURCHASER OR OWNER IS RESPONSIBLE FOR THE PERFORMANCE OF THE REQUIRED MAINTENANCE AS DEFINED BY THE MANUFACTURER IN THE OWNER/OPERATOR MANUAL.

ANY WARRANTED PART WHICH IS NOT SCHEDULED FOR REPLACEMENT AS REQUIRED MAINTENANCE, OR WHICH IS SCHEDULED ONLY FOR REGULAR INSPECTION TO THE EFFECT OF "REPAIR OR REPLACE AS NECESSARY" SHALL BE WARRANTED FOR THE WARRANTY PERIOD. ANY WARRANTED PART WHICH IS SCHEDULED FOR REPLACEMENT AS REQUIRED MAINTENANCE SHALL BE WARRANTED FOR THE PERIOD OF TIME UP TO THE FIRST SCHEDULED REPLACEMENT POINT FOR THE PART.

ANY REPLACEMENT PART THAT IS EQUIVALENT IN PERFORMANCE AND DURABILITY MAY BE USED IN NON-WARRANTY MAINTENANCE OR REPAIRS, AND SHALL NOT REDUCE THE WARRANTY OBLIGATION OF THE COMPANY.

THE COMPANY IS LIABLE FOR DAMAGES TO OTHER ENGINE COMPONENTS CAUSED BY THE FAILURE OF A WARRANTED PARTS STILL UNDER WARRANTY.

THE WARRANTY DOES NOT APPLY TO THOSE UNITS WHICH HAVE BEEN DAMAGED BY NEGLIGENCE OF INSTRUCTION LISTED IN THE OWNER/OPERATOR MANUAL FOR PROPER USE AND MAINTENANCE OF THE UNITS, ACCIDENT MISHANDLING, ALTERATION, ABUSE, IMPROPER LUBRICATION, USE OF ANY PARTS OR ACCESSORIES OTHER THAN THOSE SPECIFIED BY THE COMPANY, OR OTHER CAUSES BEYOND THE COMPANY'S CONTROL.

THIS WARRANTY DOES NOT COVER THOSE PARTS REPLACED BY NORMAL WEAR OR HARMLESS CHANGES IN THEIR APPEARANCE.

THERE ARE NO OTHER EXPRESS WARRANTIES.

IMPLIED WARRANTIES INCLUDING THOSE OF MERCHANTABILITY AND FITNESS FOR A PARTICULAR PURPOSE **ARE LIMITED TO TWO (2) YEARS OF HOME USE [ONE (1) YEAR FOR ANY OTHER USE] FROM THE ORIGINAL DELIVERY DATE.**

LIABILITIES FOR INCIDENTAL OR CONSEQUENTIAL DAMAGE UNDER ANY AND ALL WARRANTIES ARE EXCLUDED.

SOME STATES DO NOT ALLOW LIMITATION ON HOW LONG AN IMPLIED WARRANTY LASTS OR EXCLUSION OR LIMITATION OF INCIDENTAL OR CONSEQUENTIAL DAMAGES, SO THE ABOVE LIMITATION OR EXCLUSION MAY NOT APPLY TO YOU.

THIS WARRANTY GIVES YOU SPECIFIC LEGAL RIGHTS, AND YOU MAY ALSO HAVE OTHER RIGHTS WHICH VARY FROM STATE TO STATE.

IF YOU NEED TO OBTAIN INFORMATION ABOUT THE NEAREST SERVICE CENTER, PLEASE CALL KOMATSU ZENOAH AMERICA INC. AT (770)-381-5147.

IMPORTANT: YOU WILL RECEIVE A WARRANTY REGISTRATION CARD AT TIME OF PURCHASE. PLEASE FILL OUT THE CARD AND SEND IT TO RedMax / KOMATSU ZENOAH AMERICA WITHIN SEVEN (7) DAYS. BE SURE TO KEEP A COPY FOR YOUR RECORDS.



KOMATSU ZENOAH AMERICA INC.
4344 Shackelford Road Suite 500
Norcross, Georgia 30093

RedMax BLOWERS
Modèle EB7000
Garantie limitée à 2 ans

Pièces en rapport avec les émissions de gaz d'échappement : KOMATSU ZENOAH AMERICA INC., par l'intermédiaire de n'importe quel revendeur RedMax, réparera gratuitement ou remplacera gratuitement pour l'acheteur initial et chaque acheteur successif toute(s) pièce(s) se révélant de constitution et/ou de montage défectueux pendant deux (2) ans à compter de la date initiale de livraison d'une unité du modèle EB7000. Les pièces en rapport avec les émissions de gaz d'échappement sont:

**l'assemblage carburateur, l'assemblage bobine, le rotor, la bougie,
le filtre à air, le filtre à carburant, la tubulure d'admission et les joints**

Toutes autres pièces exceptées celles mentionnées ci-dessus : La société, par l'intermédiaire de n'importe quel revendeur RedMax, réparera gratuitement ou remplacera gratuitement pour l'acheteur initial toute(s) pièce (s) se révélant de constitution et/ou de montage défectueux pendant deux (2) ans en cas d'utilisation privée [un (1) an pour toute autre utilisation] à compter de la date de livraison initiale d'une unité du modèle EB7000. **Telles sont les limites de la garantie.**

Le coût du transport de l'unité jusqu'au revendeur RedMax et depuis celui-ci sera à la charge de l'acheteur.

L'acheteur ne supportera pas le coût de main d'œuvre du diagnostic qui amène à la conclusion qu'une pièce garantie est défectueuse, si ce diagnostic est effectué chez le revendeur RedMax.

L'acheteur ou propriétaire a pour responsabilité d'effectuer l'entretien obligatoire tel que défini par le fabricant dans le manuel du propriétaire/de l'utilisateur.

Toute pièce garantie dont le remplacement n'est pas prévu dans le cadre de l'entretien obligatoire, ou pour laquelle est seulement prévue une inspection périodique pour "remplacement ou réparation si nécessaire" sera garantie pour la période de garantie. Toute pièce garantie arrivée à l'échéance de son premier remplacement prévu sera garantie jusqu'à celui-ci.

Toute pièce de rechange équivalente en performance ou en durabilité peut être utilisée pour l'entretien hors-garantie ou les réparations hors-garantie, et ce sans réduire l'obligation de garantie incombant à la société.

La société sera tenue responsable des dommages aux autres composants du moteur causés par la défaillance de pièce(s) garantie(s) en période de garantie.

La garantie ne s'applique pas aux unités endommagées par suite de: négligence dans la mise en oeuvre des instructions spécifiées dans le manuel du propriétaire/de l'utilisateur en vue d'une utilisation et d'un entretien correct, fausse manœuvre accidentelle, modification, utilisation abusive, lubrification incorrecte, utilisation de pièces ou d'accessoires autres que ceux spécifiés par la société, ou autres causes hors du contrôle de la société.

Cette garantie ne couvre pas les pièces remplacées en raison de leur usure normale ou de changements d'apparence sans effets.

Il n'existe aucune autre garantie explicite.

Les garanties implicites, celles de négociabilité du produit et de son adaptabilité à un usage défini incluses, **sont limitées** à deux (2) ans pour un usage privé [un (1) an pour toute autre utilisation] à compter de la date initiale de livraison.

Les responsabilités pour les dommages conséquents ou incidents sont exclues de toutes les garanties.

Certaines provinces n'autorisant pas les limitations à la durée des garanties implicites, ou les exclusions ou limitations relatives aux dommages incidents ou conséquents, la limitation indiquée ci-dessus peut ne pas vous être applicable.

Cette garantie vous donne des droits juridiques spécifiques, et vous pouvez également jouir d'autres droits variant d'une province à l'autre.

Si vous désirez obtenir des informations sur le centre de service le plus proche, veuillez appeler KOMATSU ZENOAH AMERICA INC. au (770)-381-5147

Note importante: vous recevrez une carte d'enregistrement de garantie au moment de l'achat. Veuillez la remplir et l'adresser à RedMax / KOMATSU ZENOAH AMERICA sous sept (7) jours en prenant soin de conserver une copie pour vous.



RedMax[®]

KOMATSU ZENOAH AMERICA INC.
4344 Shackelford Road Suite 500
Norcross, Georgia 30093



KOMATSU ZENOAH AMERICA INC.
4344 Shackleford Road Suite 500
Norcross, Georgia 30093

Free Manuals Download Website

<http://myh66.com>

<http://usermanuals.us>

<http://www.somanuals.com>

<http://www.4manuals.cc>

<http://www.manual-lib.com>

<http://www.404manual.com>

<http://www.luxmanual.com>

<http://aubethermostatmanual.com>

Golf course search by state

<http://golfingnear.com>

Email search by domain

<http://emailbydomain.com>

Auto manuals search

<http://auto.somanuals.com>

TV manuals search

<http://tv.somanuals.com>