

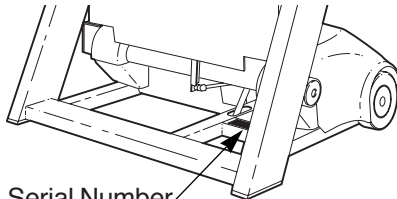

Model No. RBTL15980

Serial No. _____



Serial Number
Decal

USER'S MANUAL

QUESTIONS?

As a manufacturer, we are committed to providing complete customer satisfaction. If you have questions, or if there are missing or damaged parts, we will guarantee complete satisfaction through direct assistance from our factory.

PLEASE CALL DIRECT TO OUR TOLL-FREE CUSTOMER HOT LINE. The trained technicians on our customer hot line will provide immediate assistance, free of charge to you.

CUSTOMER HOT LINE:

1-800-999-3756

Mon.-Fri., 6 a.m.-6 p.m. MST

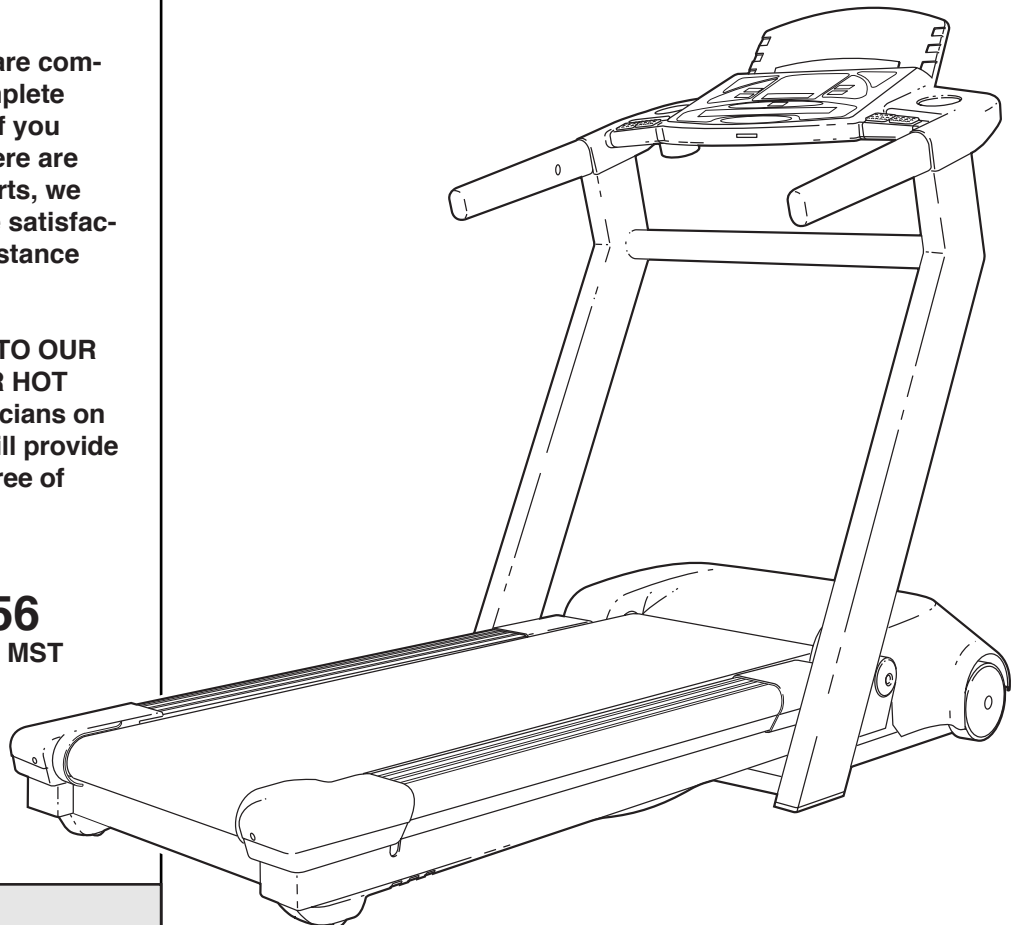

CAUTION

Read all precautions and instructions in this manual before using this equipment. Keep this manual for future reference.



TABLE OF CONTENTS

IMPORTANT PRECAUTIONS3
BEFORE YOU BEGIN5
HOW TO SET UP THE TREADMILL6
HOW TO USE THE HEART RATE MONITOR7
TREADMILL OPERATION9
HOW TO FOLD AND MOVE THE TREADMILL19
TROUBLE-SHOOTING20
REEBOK UNIVERSITY22
EXERCISE GUIDELINES24
PART LIST26
HOW TO ORDER REPLACEMENT PARTS27
LIMITED WARRANTYBack Cover

Note: An EXPLODED DRAWING is attached in the center of this manual.

IMPORTANT PRECAUTIONS

⚠ DANGER: To reduce the risk of burns, fire, electric shock, or injury to persons, read the following important precautions and information before operating the treadmill.

1. It is the responsibility of the owner to ensure that all users of this treadmill are adequately informed of all warnings and precautions.
2. Use the treadmill only as described in this manual.
3. Place the treadmill on a level surface, with at least eight feet of clearance behind it. Do not place the treadmill on any surface that blocks air openings. To protect the floor or carpet from damage, place a mat under the treadmill.
4. Keep the treadmill indoors, away from moisture and dust. Do not put the treadmill in a garage or covered patio, or near water.
5. Do not operate the treadmill where aerosol products are used or where oxygen is being administered.
6. Keep children under the age of 12 and pets away from the treadmill at all times.
7. The treadmill should not be used by persons weighing more than 300 pounds.
8. Never allow more than one person on the treadmill at a time.
9. Wear appropriate exercise clothing when using the treadmill. Do not wear loose clothing that could become caught in the treadmill. Athletic support clothes are recommended for both men and women.
10. Always wear athletic shoes when using the treadmill. Never use the treadmill with bare feet, wearing only stockings, or in sandals.
11. When connecting the power cord (see page 9), plug the power cord into a surge protector (not included) and plug the surge protector into a grounded circuit capable of carrying 15 or more amps. No other appliance should be on the same circuit. Do not use an extension cord.
12. Use only a UL-listed surge protector, rated at 15 amps, with a 14-gauge cord of five feet or less in length. Do not use an extension cord.
13. Keep the power cord and the surge protector away from heated surfaces.
14. Never move the walking belt while the power is turned off. Do not operate the treadmill if the power cord or plug is damaged, or if the treadmill is not working properly. (See **BEFORE YOU BEGIN** on page 5 if the treadmill is not working properly.)
15. Never start the treadmill while you are standing on the walking belt. Always hold the handrails while using the treadmill.
16. The treadmill is capable of high speeds. Adjust the speed in small increments to avoid sudden jumps in speed.
17. To reduce the possibility of the treadmill overheating, do not operate the treadmill continuously for longer than one hour.
18. The heart rate monitor is not a medical device. Various factors, including the user's movement, may affect the accuracy of heart rate readings. The heart rate monitor is intended only as an exercise aid in determining heart rate trends in general.
19. Never leave the treadmill unattended while it is running. Always remove the key, unplug the power cord and move the on/off switch to the off position when the treadmill is not in use. (See the drawing on page 5 for the location of the on/off switch.)
20. Do not attempt to raise, lower, or move the treadmill until it is properly set up. (See **HOW TO SET UP THE TREADMILL** on page 6 and **HOW TO MOVE THE TREADMILL** on page 19.) You must be able to safely lift 45 pounds (20 kg) to raise, lower, or move the treadmill.
21. Do not change the incline of the treadmill by placing objects under the treadmill.
22. When folding or moving the treadmill, make sure that the storage latch is fully closed.
23. Inspect and tighten all parts of the treadmill regularly.

24. Never drop or insert any object into any opening.

25. This treadmill is intended for home use only. Do not use this treadmill in any commercial, rental, or institutional setting.

26. **DANGER:** Always unplug the power cord immediately after use, before cleaning

the treadmill, and before performing the maintenance and adjustment procedures described in this manual. Never remove the motor hood unless instructed to do so by an authorized service representative. Servicing other than the procedures in this manual should be performed by an authorized service representative only.

⚠ WARNING: Before beginning this or any exercise program, consult your physician. This is especially important for persons over the age of 35 or persons with pre-existing health problems. Read all instructions before using. ICON assumes no responsibility for personal injury or property damage sustained by or through the use of this product.

SAVE THESE INSTRUCTIONS

The decals shown at the right have been placed on your treadmill. If a decal is missing, or if it is not legible, please call our Customer Service Department, toll-free, to order a free replacement decal (see **HOW TO ORDER REPLACEMENT PARTS** on page 27). Apply the decal in the location shown.

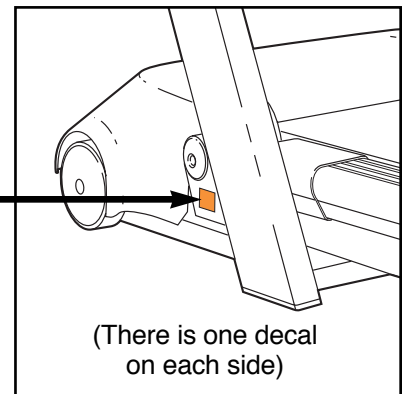
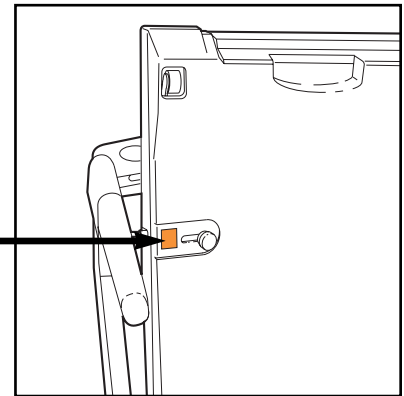

BEFORE YOU BEGIN

Thank you for selecting the new REEBOK® ACD3 treadmill. The ACD3 treadmill combines advanced technology with innovative design to let you enjoy an excellent form of cardiovascular exercise in the convenience and privacy of your home. And when you're not exercising, the unique ACD3 can be folded up, requiring less than half the floor space of other treadmills.

For your benefit, read this manual carefully before using the treadmill. If you have additional questions, please call our Customer Service Department toll-free

at 1-800-999-3756, Monday through Friday, 6 a.m. until 6 p.m. Mountain Time (excluding holidays). To help us assist you, please mention the product model number and serial number when calling. The model number is RBTL15980. The serial number can be found on a decal attached to the treadmill (see the front cover of this manual for the location).

Before reading further, please review the drawing below and familiarize yourself with the parts that are labeled.

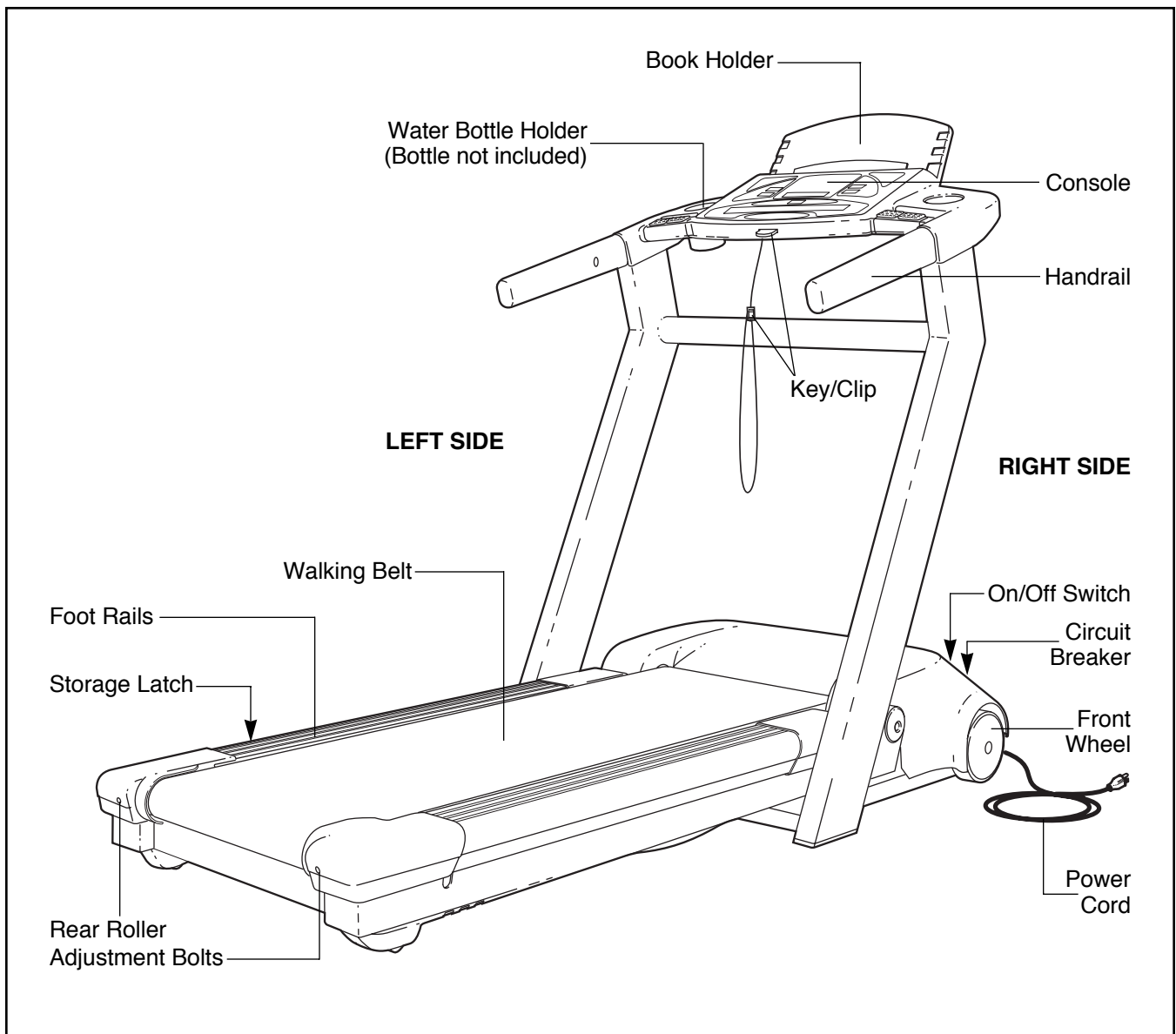

HOW TO SET UP THE TREADMILL

Set the treadmill in a cleared area and remove all packing materials. Do not dispose of the packing materials until set-up is completed. No tools are required.

1. With the help of a second person, carefully raise the Uprights (39) until the treadmill is in the position shown.

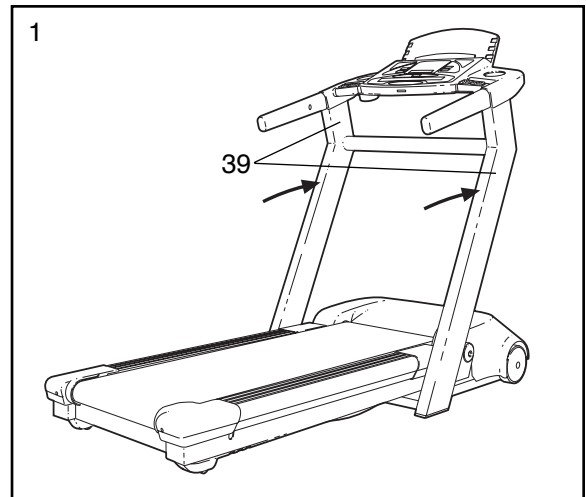

2. **Make sure that all parts are tightened before you use the treadmill.** Place a mat under the treadmill to protect the floor or carpet.

HOW TO USE THE HEART RATE MONITOR

HOW TO PUT ON THE HEART RATE MONITOR

Before you use the heart rate monitor, please read all instructions on this page and the following page.

The heart rate monitor consists of two components: the chest strap and the sensor unit. Refer to the drawing below to attach the chest strap to the sensor unit.

Insert the tab on one end of the chest strap through one end of the sensor unit. Press the end of the sensor unit under the buckle on the chest strap. The tab should be almost flush with the front of the sensor unit.

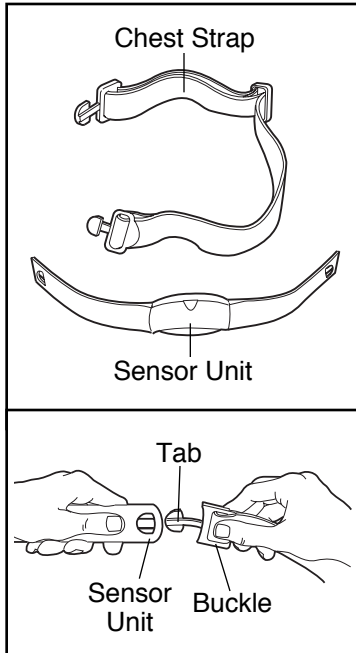

Next, wrap the heart rate monitor around your chest and attach the other end of the chest strap to the sensor unit. Adjust the length of the chest strap, if necessary.

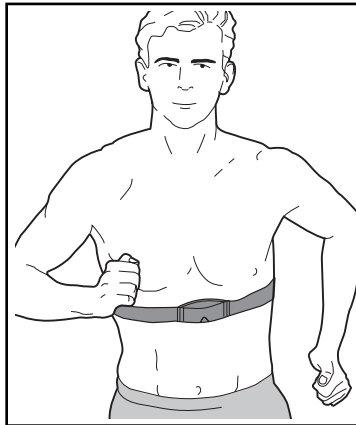

The heart rate monitor should be under your clothing, tight against your skin, and as high under the pectoral muscles or breasts as is comfortable. Make sure that the logo on the sensor unit is facing forward and is right-side-up.

Pull the sensor unit away from your body a few inches and locate the two electrode areas on the inner side. The electrode areas are the areas covered by shallow ridges. Using saline solution such as saliva or contact lens solution, wet both electrode areas. Return the sensor unit to a position against your chest.

HEART RATE MONITOR CARE AND MAINTENANCE

- Thoroughly dry the heart rate monitor after each use. The heart rate monitor is activated when the electrode areas are wetted and the heart rate monitor is put on; the heart rate monitor shuts off when it is removed and the electrode areas are dried. If the heart rate monitor is not dried after each use, it may remain activated longer than necessary, draining the battery prematurely.
- Store the heart rate monitor in a warm, dry place. Do not store the heart rate monitor in a plastic bag or other container that may trap moisture.
- Do not expose the heart rate monitor to direct sunlight for extended periods of time
- Do not expose the heart rate monitor to temperatures above 122° Fahrenheit (50° Celsius) or below 14° Fahrenheit (-10° Celsius).
- Do not excessively bend or stretch the sensor unit when using or storing the heart rate monitor.
- Clean the sensor unit periodically using a damp cloth; never use alcohol, abrasives, or chemicals. The chest strap may be hand washed and air dried.

HEART RATE MONITOR TROUBLE-SHOOTING

The instructions on the following pages explain how the heart rate monitor is used with the console. If the letters “PLS” appear in the PULSE display or if the displayed heart rate is excessively high or low, try the steps below.

- Make sure that the heart rate monitor is under your clothing, tight against your skin, and as high under the pectoral muscles or breasts as is comfortable. In addition, make sure that the logo on the sensor unit is facing forward and is right-side-up. Note: If the heart rate monitor does not function when positioned as described, try moving it slightly lower or higher on your chest.
- Use saline solution such as saliva or contact lens solution to wet the two electrode areas on the sensor unit. If heart rate readings do not appear until you begin perspiring, re-wet the electrode areas.

- As you walk or run on the treadmill, position yourself near the center of the walking belt. **For the console to display heart rate readings, the user must be within arm's length of the console.**
- The heart rate monitor is designed to work with people who have normal heart rhythms. Heart rate reading problems may be caused by medical conditions such as premature ventricular contractions (pvc's), tachycardia bursts, and arrhythmia.
- The operation of the heart rate monitor can be affected by magnetic interference caused by high power lines or other sources. If it is suspected that this is a problem, try relocating the treadmill.

- The CR2032 battery may need to be replaced. Follow the steps below to replace the battery.

Locate the battery cover on the back of the sensor unit. Insert a coin into the slot in the cover and turn the cover counterclockwise to the "open" position. Remove the cover.

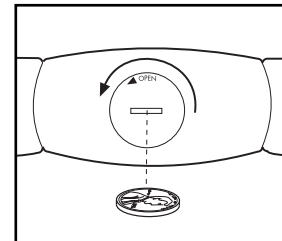

Remove the old battery from the sensor unit. Insert a new **CR 2032 battery**, making sure that the writing is on top. In addition, make sure that the rubber gasket is in place in the sensor unit. Replace the battery cover and turn it to the closed position.

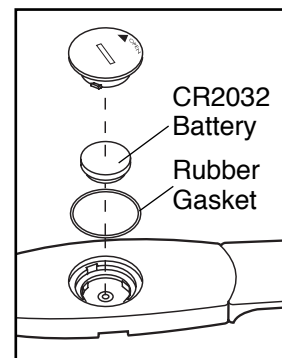

TREADMILL OPERATION

THE PERFORMANT LUBE™ WALKING BELT

Your treadmill features a walking belt coated with PERFORMANT LUBE™, a high-performance lubricant. **IMPORTANT: Never apply silicone spray or other substances to the walking belt or the walking platform. They will deteriorate the walking belt and cause excessive wear.**

HOW TO PLUG IN THE POWER CORD

⚠ DANGER: Improper connection of the equipment-grounding conductor can result in an increased risk of electric shock. Check with a qualified electrician or serviceman if you are in doubt as to whether the product is properly grounded. Do not modify the plug provided with the product—if it will not fit the outlet, have a proper outlet installed by a qualified electrician.

Your treadmill, like any other type of sophisticated electronic equipment, can be seriously damaged by sudden voltage changes in your home's power. Voltage surges, spikes, and noise interference can result from weather conditions or from other appliances being turned on or off.

To decrease the possibility of your treadmill being damaged, always use a surge protector (not included) with your treadmill.

Surge protectors are sold at most hardware stores and department stores. Use only a UL-listed surge protector, rated at 15 amps, with a 14-gauge cord of five feet or less in length.

This product must be grounded. If it should malfunction or break down, grounding provides a path of least resistance for electric current to reduce the risk of

electric shock. This product is equipped with a cord having an equipment-grounding conductor and a grounding plug. **Plug the power cord into a surge protector, and plug the surge protector into an appropriate outlet that is properly installed and grounded in accordance with all local codes and ordinances.**

This product is for use on a nominal 120-volt circuit, and has a grounding plug that looks like the plug illustrated in drawing 1 below. A temporary adapter that looks like the adapter illustrated in drawing 2 may be used to connect the surge protector to a 2-pole receptacle as shown in drawing 2 if a properly grounded outlet is not available.

The temporary adapter should be used only until a properly grounded outlet (drawing 1) can be installed by a qualified electrician.

The green-colored rigid ear, lug, or the like extending from the adapter must be connected to a permanent ground such as a properly grounded outlet box cover. Whenever the adapter is used it must be held in place by a metal screw. **Some 2-pole receptacle outlet box covers are not grounded. Contact a qualified electrician to determine if the outlet box cover is grounded before using an adapter.**

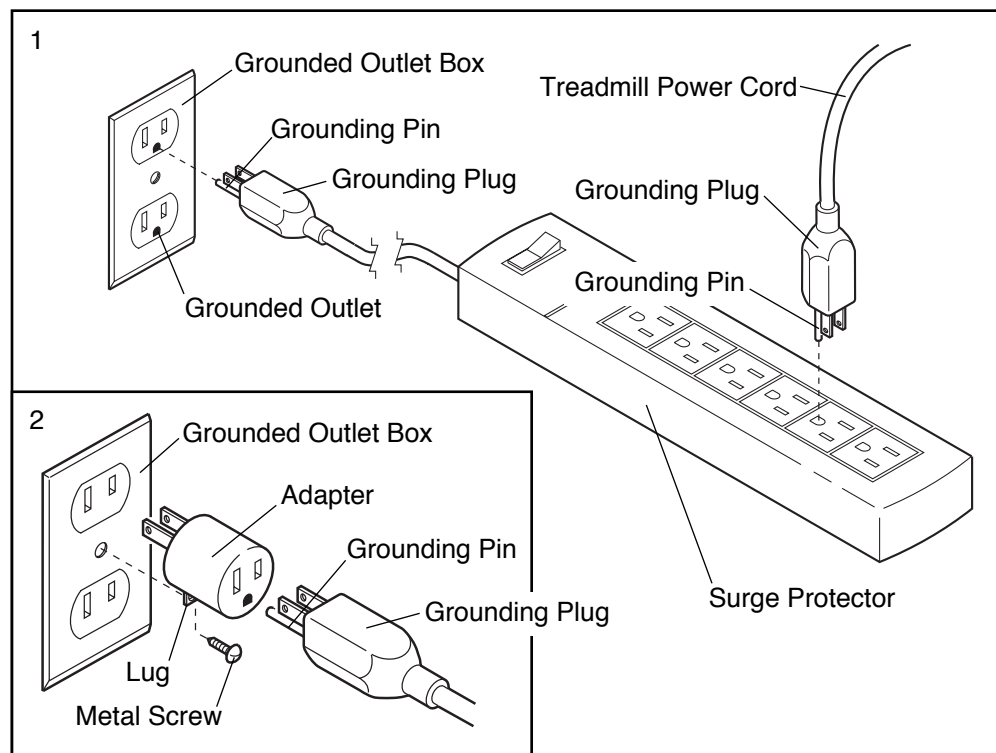

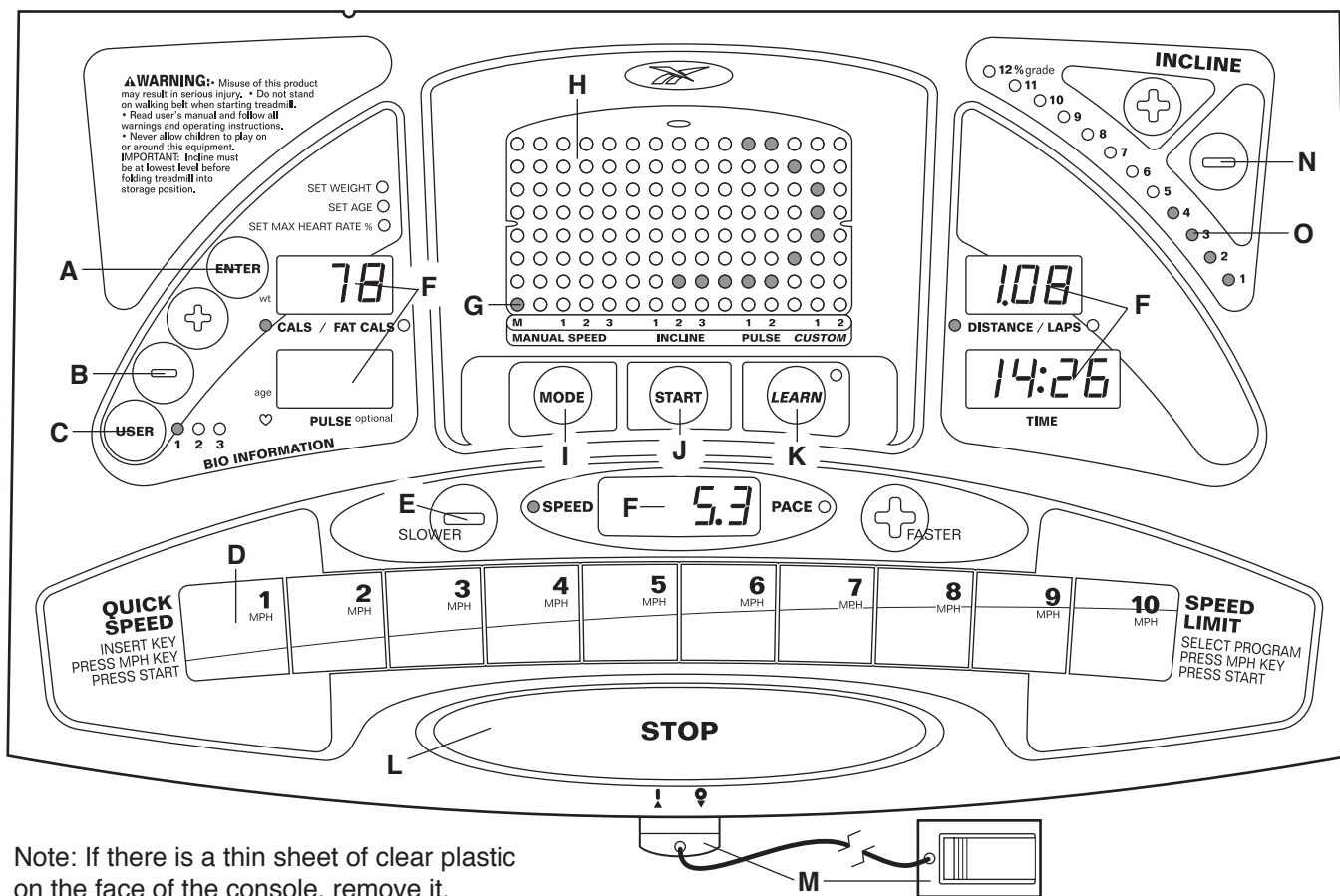

Note: If there is a thin sheet of clear plastic on the face of the console, remove it.

⚠ CAUTION: Before operating the console, read the following precautions.

- Do not stand on the walking belt when turning on the power or starting the walking belt.
- Always wear the clip (see M above) while operating the treadmill. If the key is pulled from the console, the walking belt will stop.
- The treadmill is capable of high speeds; adjust the speed in small increments.
- The heart rate monitor is not a medical device. Various factors may affect the accuracy of heart rate readings. The heart rate monitor is intended only as an exercise aid in determining heart rate trends in general.
- If you have heart problems, or if you are over 60 years of age and have been inactive, do not use the two pulse driven programs. If you are taking medication regularly, consult your physician to find whether the medication will affect your exercise heart rate.
- To reduce the risk of electric shock, keep the console dry. Avoid spilling liquid on the console and use only a sealable water bottle.

FEATURES OF THE CONSOLE

The advanced console offers an impressive array of features to make your workouts more effective. When the console is in the manual mode, the speed and incline of the treadmill can be changed with a touch of a button. As you exercise, the LED displays will provide continuous exercise feedback.

The console also offers eight preset workout programs: three speed programs automatically control the speed of the treadmill as they guide you through effective workouts; three incline programs automatically control the incline of the treadmill; and two pulse programs automatically control the speed and the incline of the treadmill to keep your heart rate within a predetermined range during your workouts. You can even create custom workout programs and store them in the console's memory for future use.

To use the manual mode, see page 12; to use a speed program or an incline program, see page 14; to use a pulse program, see page 15; to create and use a custom program, see pages 16 and 17.

Note: The console can display speed and distance in either miles or kilometers (see page 13). For simplicity, all instructions in this section refer to miles.

DIAGRAM OF THE CONSOLE

Refer to the drawing at the top of page 10.

- A. ENTER Button—This button is used to enter age, weight and maximum heart rate settings.
- B. + and – Buttons—These buttons are used to change age, weight and maximum heart rate settings.
- C. USER Button—This button is used to select user information. Up to three different users can store age, weight and maximum heart rate settings.
- D. QUICK SPEED Buttons—These buttons allow you to quickly select speed settings.
- E. SPEED Buttons—These buttons control the speed of the walking belt. Each time a button is pressed, the speed will change by 0.1 mph; if a button is held down, the speed will change in increments of 0.5 mph. The speed range is 0.5 mph to 10 mph.
- F. LED Displays—These displays provide continuous feedback of calories and fat calories burned, distance, laps completed, elapsed time, speed and pace. In addition, the PULSE display shows your heart rate when the heart rate monitor is worn.
- G. MANUAL/Program Indicators—These indicators show when the manual mode is selected and when a workout program is selected.
- H. LED Matrix—When the manual mode is selected, this matrix shows your progress on an LED track. When a workout program is selected, the matrix shows upcoming incline or speed changes.
- I. MODE Button—This button is used to select the manual mode and workout programs.
- J. START Button—This button starts the walking belt.
- K. LEARN Button—This button is used to program speed and incline settings for custom programs.
- L. STOP Button—This button stops the walking belt. When the button is pressed, the LED displays will pause and the TIME display will flash. If the button is held down for two seconds, the displays will be reset.
- M. Key with Clip—The key turns the console on and off. The attached clip is designed to be worn on your waistband. If the key is pulled from the console, the power will automatically turn off.

- N. INCLINE Buttons—These buttons control the incline of the treadmill. Each time a button is pressed, the incline will change by 0.5%. The incline range is 1.5% to 12%.
- O. INCLINE Display—This display shows the incline level of the treadmill. The first indicator will light when the incline is at 1.5%. The second indicator will light when the incline is at 2% or 2.5%, the third indicator will light when the incline is at 3% or 3.5%, and so on.

HOW TO TURN ON THE POWER

Make sure that the on/off switch, located on the front of the treadmill, is in the on position.

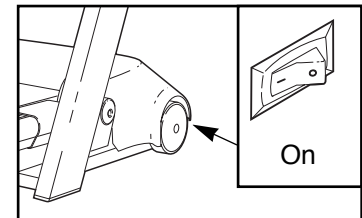

Next, make sure that the power cord is properly plugged in (see page 9).

Step onto the foot rails of the treadmill. Find the clip attached to the key, and slide the clip onto the waistband of your clothing. Next, insert the key into the console. After a moment, various displays and indicators will light.

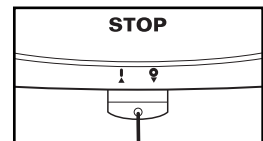

HOW TO ENTER USER INFORMATION

Each time the power is turned on, the USER 1 indicator will begin to flash. The console allows up to three different users to enter their weight, their age and a maximum heart rate setting into the console.

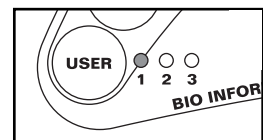

If you enter your weight into the console, the CALS/FAT CALS display will be more accurate. If you want to use a pulse program, you must enter your age and a maximum heart rate setting.

If you want to enter your weight, your age or a maximum heart rate setting, follow the instructions on page 12.

1 Press the USER button.

Press the USER button to designate yourself as user 1. The USER 1 indicator will light without flashing. Note: To designate yourself as user 2 or user 3, press the USER button repeatedly.

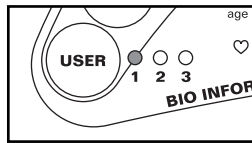

2 Enter your weight if desired.

The current weight setting will be shown in the CALS/FAT CALS display. Press the + or – button to enter your weight. Each button press will change the weight setting by 1 pound; if a button is held down, the setting will change in increments of 5 pounds. When your weight is shown, press the ENTER button. Note: Once your weight is entered, it will be saved in memory, even when the power cord is unplugged.

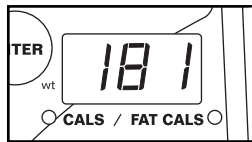

3 Enter your age if desired.

The current age setting will be shown in the PULSE display. Press the + or – button to enter your age. Each button press will change the age setting by 1 year; if a button is held down, the setting will change in increments of 5 years. When your age is shown, press the ENTER button. Note: Once your age is entered, it will be saved in memory, even when the power cord is unplugged.

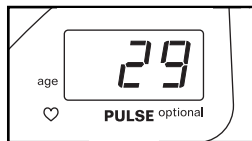

4 Enter a maximum heart rate setting if desired.

The current heart rate setting will be shown in the LED matrix. This setting is a percentage of your maximum possible heart rate.

When a PULSE program is used, this is the highest level that your heart rate will reach during the program. If desired, you can change the maximum heart rate setting by pressing the + and – buttons. Each button press will change the setting by 1 %; if a button is held down, the setting will change in increments of 5%. The setting can be from 70% to 85%. When the desired setting is shown, press

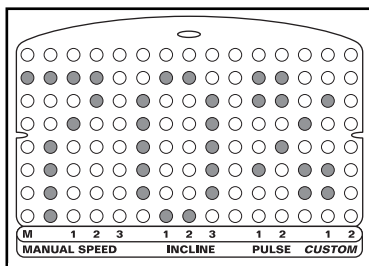

the ENTER button. Note: When the key is removed from the console, the maximum heart rate setting will be reset to 70%.

HOW TO USE THE MANUAL MODE

1 Insert the key into the console.

See HOW TO TURN ON THE POWER on page 11. **Note: When you are familiar with the console, you may go directly to step 4. While learning to use the console, please read steps 2 and 3.**

2 Enter your weight if desired.

If you have not entered your weight, see HOW TO ENTER USER INFORMATION on page 11.

3 Select the MANUAL mode.

When the key is inserted, the MANUAL mode will automatically be selected. If you have selected a workout program, you can select the MANUAL mode again by pressing the MODE button repeatedly until the MANUAL indicator lights.

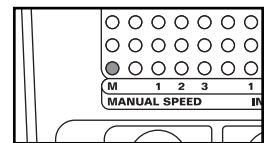

4 Press the START button or the SPEED + button to start the walking belt.

A moment after the button is pressed, the walking belt will begin to move at 1.0 mph. Hold the handrails and carefully begin walking. As you exercise, change the speed of the walking belt as desired by pressing the SPEED buttons or the QUICK SPEED buttons. **CAUTION: Change the speed in small increments to avoid sudden jumps in speed.**

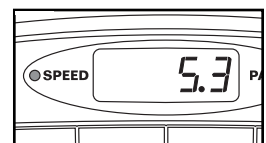

To stop the walking belt for a moment, press the STOP button. The displays will pause and the TIME display will begin to flash. To restart the walking belt, press the START button or the SPEED + button. Note: To stop the walking belt and reset all displays, hold down the STOP button for two seconds.

Note: When one of the SPEED buttons is pressed, the SPEED/PACE display will show the selected speed setting for seven seconds. The display will then show the actual speed of the walking belt.

5 Adjust the incline as desired.

To vary the intensity of your workout, change the incline of the treadmill as desired by pressing the INCLINE buttons. Note: After the INCLINE buttons are pressed, it may take a moment for the treadmill to reach the selected incline setting.

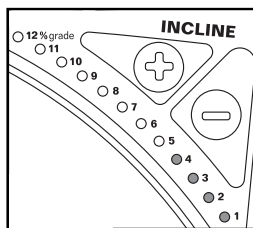

6 Follow your progress with the LED track and the LED displays.

The LED Track—The LED track represents a distance of 1/4 mile. As you exercise, the indicators around the track will light one at a time until you have completed 1/4 mile. A new lap will then begin.

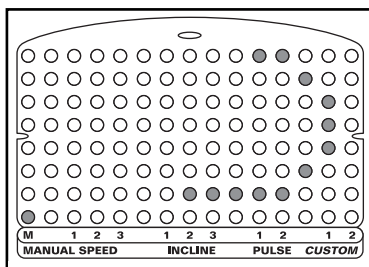

CALS/FAT CALS display—This display shows the approximate numbers of calories and fat calories you have burned (see FAT BURNING on page 24). Every seven seconds, the display will change from one number to the other.

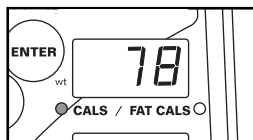

PULSE display—This display shows your heart rate when the heart rate monitor is worn. (See HOW TO USE THE HEART RATE MONITOR on page 7.)



SPEED/PACE display—This display shows both the speed of the walking belt and your current pace (pace is measured in minutes per mile). The display will alternate between one number and the other every seven seconds. Note: Each time the SPEED buttons are pressed, the display will show the speed setting.

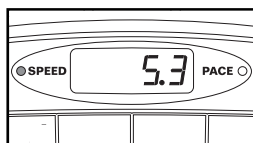

How to select miles per hour or kilometers per hour: Speed can be displayed in either miles per hour (mph) or kilometers per hour (kph). To check the unit of measurement, first hold down the STOP button while inserting the key into the console. The SPEED/PACE display will show an "E" (for English miles) or an "M" (for Metric kilometers). Press the SPEED + button to change the unit of measurement. Remove and then reinsert the key.

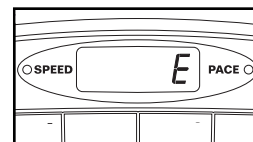

DISTANCE/LAPS display—This display shows both the distance that the walking belt has moved and the number of laps you have completed (one lap equals 1/4 mile). The display will alternate between one number and the other every seven seconds.

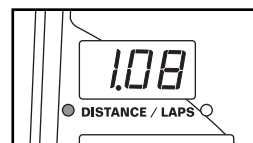

Note: If the speed is displayed in miles per hour, the distance will be displayed in miles; if the speed is displayed in kilometers per hour, the distance will be displayed in kilometers.

TIME display—This display shows the total time that the walking belt has been moving. Note: When a workout program is selected, this display will show the time remaining in the program.



7 When you are finished exercising, stop the walking belt and remove the key.

Step onto the foot rails and press the STOP button. Next, lower incline of the treadmill to its lowest setting. **The incline must be at its lowest setting when the treadmill is folded to the storage position or the treadmill will be damaged.** Remove the key from the console and put it in a secure place. In addition, move the on/off switch to the off position and unplug the power cord.

HOW TO USE THE SPEED PROGRAMS AND THE INCLINE PROGRAMS

The three speed programs automatically control the speed of the treadmill as they guide you through effective workouts; the three incline programs automatically control the incline of the treadmill.

Follow the steps below to use a speed program or an incline program.

1 Insert the key into the console.

See HOW TO TURN ON THE POWER on page 9.

2 Enter your weight if desired.

If you have not entered your weight, see HOW TO ENTER USER INFORMATION on page 9.

3 Select the desired program.

When the key is inserted, the MANUAL mode will be selected. To select a speed program or an incline program, press the MODE button repeatedly until the desired speed or incline program indicator lights. The first thirteen settings of the program you have selected will appear in the LED matrix (the function of the LED matrix will be explained later).

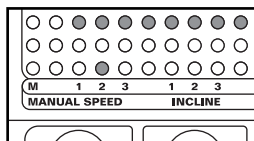

4 Select a maximum speed or incline setting.

If you selected a speed program: A number will begin to flash in the SPEED/PACE display.

This number is the maximum speed that the walking belt will reach during the program. If you want to change the maximum speed setting, press the QUICK SPEED buttons. The maximum speed setting can be from 4 mph to 10 mph. Note: The speed range of all speed programs is 3 mph. If the maximum speed setting is 4 mph, the speed range of the program will be 1 mph to 4 mph; if the maximum speed setting is 10 mph, the speed range will be 7 mph to 10 mph.

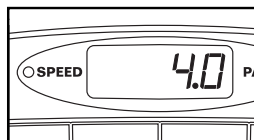

If you selected an incline program: The incline display will flash to show the maximum incline level that the treadmill will reach during the program. If you want to change the maximum incline setting, press the INCLINE buttons. The maximum incline setting can be from 4% to 10%. Note: The incline range of all incline programs is 3%. If the maximum incline setting is 4%, the incline range of the program will be 1% to 4%; if the maximum incline setting is 10%, the incline range will be 7% to 10%.

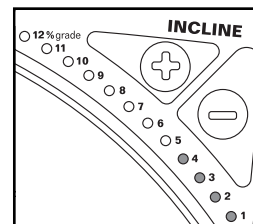

5 Press the START button or the SPEED + button to start the program.

A moment after the button is pressed, the walking belt will begin to move. (If an incline program is selected, the treadmill will also adjust to the first incline setting of the program, unless it is already at the first setting.) Hold the handrails and carefully begin walking.

Each program consists of twenty or thirty, one-minute periods. (The length of the program is shown in the TIME display.) If a speed program is selected, one speed setting is programmed for each period; if an incline program is selected, one incline setting is programmed for each period. The speed or incline settings will be shown in the LED matrix. The speed or incline setting of the first period will be shown in the flashing CURRENT PERIOD column.

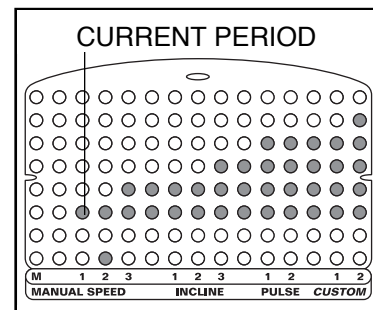

The settings of the next twelve periods will be shown in the twelve columns to the right.

When only three seconds remain in the first period, both the CURRENT PERIOD column and the column to the right will flash and three tones will sound. All speed or incline settings will then move one column to the left. The setting of the second period will then be shown in the CURRENT PERIOD column and the treadmill will automatically adjust to that setting.

If an incline program is selected, the speed of the treadmill can be changed during the program with the SPEED buttons or the QUICK SPEED buttons. If a speed program is selected, the incline of the treadmill can be changed with the INCLINE buttons.

The program will continue until the speed or incline setting of the last period is shown in the CURRENT PERIOD column of the LED matrix and the TIME display counts down to zero. The walking belt will then slow to a stop.

If the program is too easy or too difficult, the intensity of the program can be adjusted. If a speed program is selected, press the SPEED buttons or the QUICK SPEED buttons to adjust the maximum speed setting; if an incline program is selected, press the INCLINE buttons to adjust the maximum incline setting (see step 4 on page 14).

To stop the program for a moment, press the STOP button. The displays will pause and the TIME display will begin to flash. To restart the program, press the START button or the SPEED + button. To end the program at any time, hold down the STOP button for two seconds. The MANUAL mode will then be selected.

6 Follow your progress with the LED displays.

See step 6 on page 13.

7 When you are finished exercising, remove the key.

Make sure that the incline of the treadmill is at its lowest setting. **The incline must be at its lowest setting when the treadmill is folded to the storage position or the treadmill will be damaged.** Remove the key from the console and put it in a secure place. In addition, move the on/off switch to the off position and unplug the power cord.

HOW TO USE THE PULSE PROGRAMS

The two pulse programs automatically control the speed and the incline of the treadmill to keep your heart rate within a predetermined range during your workouts.

Follow the instructions below to use a pulse program.

1 Insert the key into the console.

See HOW TO TURN ON THE POWER on page 11.

2 Enter your weight, your age, and a maximum heart rate setting.

If you enter your weight into the console, the CALS/FAT CALS display will be more accurate. **To use a pulse program, you must enter your age and a maximum heart rate setting.** If you have not entered this information, see HOW TO ENTER USER INFORMATION on page 11.

3 Put on the heart rate monitor.

The heart rate monitor must be worn when a pulse program is used. (See HOW TO USE THE HEART RATE MONITOR on page 7.) Note: A pulse program can be started without a heart rate reading; however, the speed and/or incline of the treadmill will automatically decrease if your heart rate is not detected during the program.

4 Select the desired program.

When the key is inserted, the MANUAL mode will be selected. To select a pulse program, press the MODE button repeatedly until one of the pulse

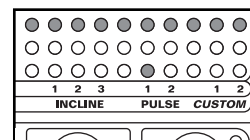

program indicators lights. The first thirteen settings of the program you have selected will appear in the LED matrix (the function of the LED matrix will be explained later).

5 Press the START button or the SPEED + button to start the program.

A moment after the button is pressed, the walking belt will begin to move. Hold the handrails and carefully begin walking.

Each pulse program consists of thirty, one-minute periods. One heart rate setting is programmed for each period. The heart rate settings will be shown in the LED matrix. The heart rate setting of the first period will be shown in the flashing **CURRENT PERIOD** column. The settings of the next twelve periods will be shown in the twelve columns to the right.

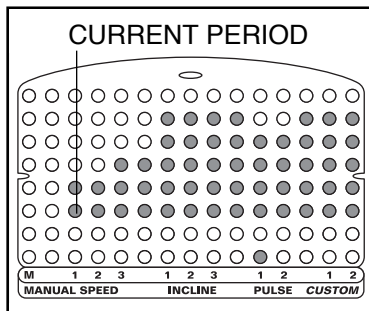

When only three seconds remain in the first period, both the **CURRENT PERIOD** column and the column to the right will flash and three tones will sound. All heart rate settings will then move one column to the left. The setting of the second period will then be shown in the **CURRENT PERIOD** column.

As the program progresses, the speed and/or incline of the treadmill will change at any time to keep your heart rate near the setting shown in the **CURRENT PERIOD** column. The program will continue until the heart rate setting of the last period is shown in the **CURRENT PERIOD** column and the **TIME** display counts down to zero. The walking belt will then slow to a stop.

If your heart rate is not detected during the program, the letters "PLS" will flash in the **PULSE** display and the speed and/or incline of the treadmill will automatically decrease. (See **HEART RATE MONITOR TROUBLE-SHOOTING** on page 7.)

While the program is in progress, minor adjustments can be made to the speed or incline of the treadmill with the **SPEED** or **INCLINE** buttons. However, if you increase the speed, the incline will automatically decrease; if you decrease the speed, the incline will increase. If you increase the incline, the speed will decrease; if you decrease the incline, the speed will increase. The console will always attempt to keep your heart rate near the heart rate setting shown in the **CURRENT PERIOD** column. Note: When the incline reaches the lowest setting, the speed cannot be increased any further. When the incline reaches the highest setting, the speed cannot be decreased any further.

6 Follow your progress with the LED displays.

See step 6 on page 13.

7 When you are finished exercising, remove the key.

Make sure that the incline of the treadmill is at its lowest setting. **The incline must be at its lowest setting when the treadmill is folded to the storage position or the treadmill will be damaged.** Remove the key from the console and put it in a secure place. In addition, move the on/off switch to the off position and unplug the power cord.

HOW TO CREATE CUSTOM PROGRAMS

The Custom 1 and Custom 2 programs are workout programs that you create. The programs control both the speed and the incline of the treadmill, and can be up to 40 minutes long. The programs are stored in memory and can be changed as many times as desired.

Follow the steps below to create a custom program.

1 Insert the key into the console.

See **HOW TO TURN ON THE POWER** on page 11.

2 Enter your weight if desired.

If you have not entered your weight, see **HOW TO ENTER USER INFORMATION** on page 11.

3 Select the Custom 1 or Custom 2 program.

When the key is inserted, the **MANUAL** mode will be selected. To select a custom program, press the **MODE** button repeatedly until the Custom 1 or Custom 2 program indicator lights.

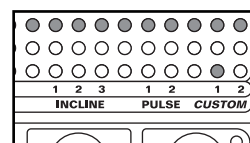

4 Press the START button or the SPEED + button to start the program.

A moment after the button is pressed, the walking belt will begin to move. Hold the handrails and carefully begin walking.

5 Press the LEARN button and program the desired speed and incline settings.

When the **LEARN** button is pressed, the **LEARN** indicator will light. **Speed and incline settings can be programmed only when the indicator is lit.**

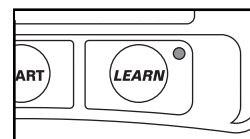

Each program is divided into one-minute periods. One speed setting and one incline setting can be programmed for each period. The speed setting of the first period is shown in the flashing CURRENT PERIOD column of the LED matrix. (The incline settings are not shown in the matrix.) To program speed and incline

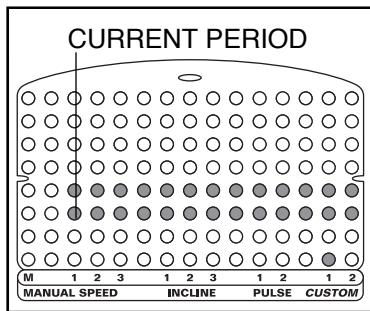

settings for the first period, simply adjust the speed and incline of the treadmill to the desired levels with the SPEED and INCLINE buttons. Every few times the SPEED buttons are pressed, one additional indicator will light or darken in the CURRENT PERIOD column.

When the first period is completed, three tones will sound and the current speed and incline settings will be stored in memory. All settings shown in the LED matrix will then move one column to the left and the speed setting of the second period will be shown in the CURRENT PERIOD column. Program speed and incline settings for the second period as described above. Repeat this procedure until you have programmed speed and incline settings for as many periods as desired. Programs can have up to forty periods.

Note: To stop the program for a moment, press the STOP button. The displays will pause and the TIME display will begin to flash. To restart the program, press the START or SPEED + button.

6 Hold down the STOP button for two seconds.

When you have programmed speed and incline settings for as many one-minute periods as desired, hold down the STOP button for two seconds. The speed and incline settings that you have programmed and the length of the program will be stored in memory. To use the program again, see HOW TO USE CUSTOM PROGRAMS at the right.

7 When the program is completed, remove the key.

Make sure that the incline of the treadmill is at its lowest setting. **The incline must be at its lowest setting when the treadmill is folded to the storage position or the treadmill will be damaged.** Remove the key from the console and put it in a secure place. In addition, move the on/off switch to the off position and unplug the power cord.

HOW TO USE THE CUSTOM PROGRAMS

1 Insert the key into the console.

See HOW TO TURN ON THE POWER on page 11.

2 Enter your weight if desired.

If you have not entered your weight, see HOW TO ENTER USER INFORMATION on page 11.

3 Select the Custom 1 or Custom 2 program.

When the key is inserted, the MANUAL mode will be selected. To select a custom program, press the MODE button repeatedly until the Custom 1 or Custom 2 program indicator lights.

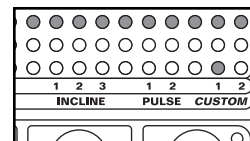

4 Press the START button or the SPEED + button to start the program.

A moment after the button is pressed, the walking belt will begin to move. Hold the handrails and carefully begin walking.

Each program is divided into one-minute periods. One speed setting and one incline setting are programmed for each period.

The speed setting of the first period is shown in the flashing CURRENT PERIOD column of the LED matrix. (The incline settings are not shown in the matrix.)

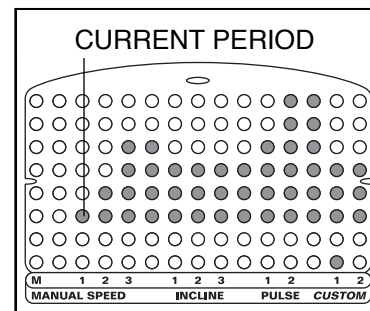

When only three seconds remain in the first period, both the CURRENT PERIOD column and the column to the right will flash and three tones will sound. All speed and incline settings will then move one column to the left. The speed setting of the second period will then be shown in the CURRENT PERIOD column and the speed and incline of the treadmill will adjust to the second settings that you programmed previously.

The program will continue until the speed setting of the last period is shown in the CURRENT PERIOD column of the LED matrix and the TIME display counts down to zero. The walking belt will then slow to a stop.

During the program, the speed and incline settings of the current period can be adjusted with the SPEED and INCLINE buttons. Adjustments will not be stored in memory. To **reprogram** speed and incline settings, press the LEARN button. The LEARN indicator will light. **Speed and incline settings can be reprogrammed only when the indicator is lit.** Next, adjust the speed and incline of the treadmill with the SPEED and INCLINE buttons. When the current period of the program is completed, the new speed and incline settings will be stored in memory. When you have reprogrammed speed and incline settings for as many periods as desired, press the LEARN button again.

To stop the program for a moment, press the STOP button. The displays will pause and the TIME display will begin to flash. To restart the program, press the START button or the SPEED + button. To end the program at any time, hold down the STOP button for two seconds. The MANUAL mode will then be selected.

5 Follow your progress with the LED displays.

Refer to step 6 on page 13.

6 When the program is completed, remove the key.

Make sure that the incline of the treadmill is at its lowest setting. **The incline must be at its lowest setting when the treadmill is folded to the storage position or the treadmill will be damaged.** Remove the key from the console and put it in a secure place. In addition, move the on/off switch to the off position and unplug the power cord.

THE INFORMATION MODE

The console features an information mode that keeps track of the total time and distance accumulated on the treadmill. The information mode also allows you to switch the console from miles to kilometers.

To select the information mode, hold down the STOP button while inserting the key into the console. When the information mode is selected, the following information will be shown:

The SPEED/PACE display will show an "E" (for English miles) or an "M" (for Metric kilometers). The unit of measurement can be changed by pressing the SPEED + button.

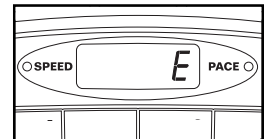

The TIME display will show the total number of hours that the treadmill has been used.

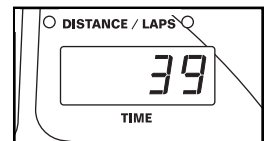

The DISTANCE/LAPS display will show the total number of miles that the walking belt has moved.

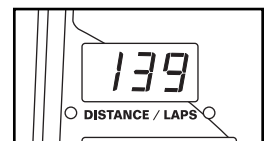

To exit this mode, remove the key from the console.

HOW TO FOLD AND MOVE THE TREADMILL

HOW TO FOLD THE TREADMILL FOR STORAGE

Before folding the treadmill, adjust the incline to the lowest position. If this is not done, the treadmill may be permanently damaged. Next, unplug the power cord. **CAUTION: You must be able to safely lift 45 pounds (20 kg) in order to raise, lower, or move the treadmill.**

1. Hold the treadmill with your hands in the locations shown at the right. **CAUTION: To decrease the possibility of injury, bend your legs and keep your back straight. As you raise the treadmill, make sure to lift with your legs rather than your back.** Raise the treadmill about halfway to the vertical position.

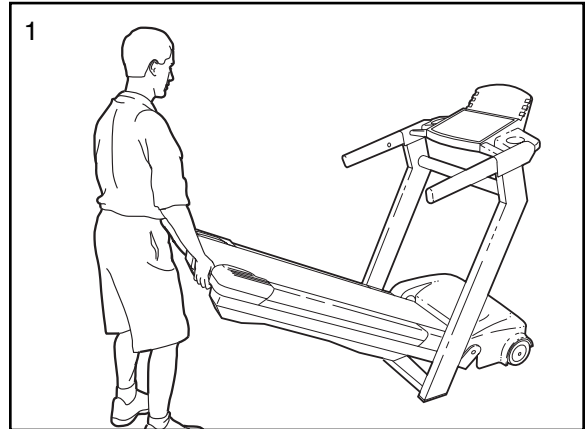

2. Move your right hand to the position shown and hold the treadmill firmly. Using your left hand, slide the storage knob to the right and hold it. Raise the treadmill until the locking pin is aligned with the hole in the left handrail. Slowly release the storage knob so that the locking pin slides into the left handrail. **Make sure that the locking pin is inserted into the left handrail.**

To protect the floor or carpet from damage, place a mat under the treadmill. Keep the treadmill out of direct sunlight. Do not leave the treadmill in the storage position in temperatures above 85° Fahrenheit.

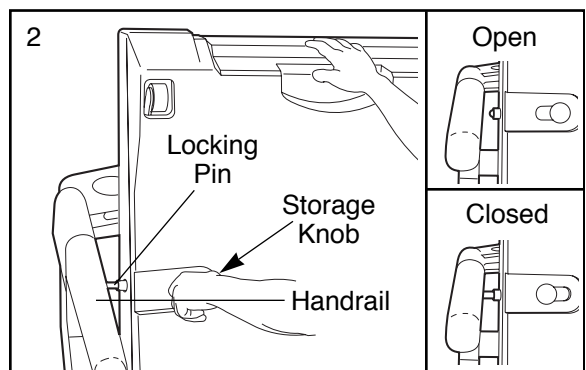

HOW TO MOVE THE TREADMILL

Before moving the treadmill, convert the treadmill to the storage position as described above. **Make sure that the locking pin is inserted into the left handrail.**

1. Hold the handrails as shown and place one foot against the hood **only in the location shown. Do not hold or push on the book holder or it may be damaged.**
2. Tilt the treadmill back until it rolls freely on the wheels. Carefully move the treadmill to the desired location. **Never move the treadmill without tipping it back. To reduce the risk of injury, use extreme caution while moving the treadmill. Do not attempt to move the treadmill over an uneven surface.**
3. Place one foot on the base and carefully lower the treadmill until it is resting in the storage position.

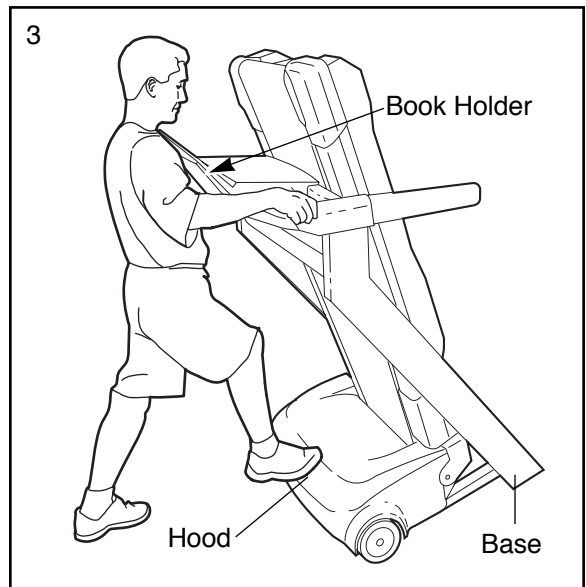

HOW TO LOWER THE TREADMILL FOR USE

1. Refer to drawing 2 above. Hold the upper end of the treadmill with your right hand as shown. Using your left hand, slide the storage knob to the right. Pivot the treadmill down until the frame is past the left handrail.
2. Refer to drawing 1 above. Hold the treadmill firmly with both hands and lower the treadmill to the floor. **CAUTION: To decrease the possibility of injury, bend your legs and keep your back straight.**

TROUBLE-SHOOTING

Most treadmill problems can be solved by following the steps below. Find the symptom that applies, and follow the steps listed. If further assistance is needed, please call our Customer Service Department toll-free at 1-800-999-3756, Monday through Friday, 6 a.m. until 6 p.m. Mountain Time (excluding holidays).

PROBLEM: The power does not turn on

SOLUTION: a. Make sure that the power cord is plugged into a surge protector, and that the surge protector is plugged into a properly grounded outlet. (See HOW TO PLUG IN THE POWER CORD on page 9.) Use only a UL-listed surge protector, rated at 15 amps, with a 14-gauge cord of five feet or less in length.

b. After the power cord has been plugged in, make sure that the key is inserted into the console as far as it will go.

c. Check the circuit breaker located on the treadmill near the power cord. If the switch protrudes as shown, the circuit breaker has tripped. To reset the circuit breaker, wait for five minutes and then press the switch back in.

d. Check the on/off switch located on the treadmill near the power cord. The switch must be in the on position.

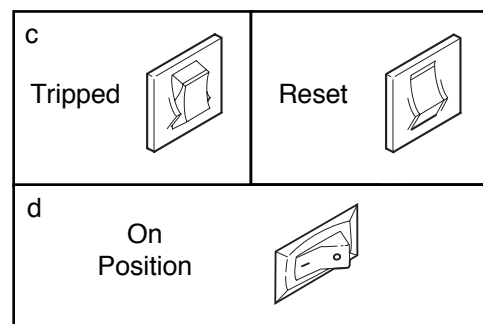

PROBLEM: The power turns off during use

SOLUTION: a. Check the circuit breaker located on the treadmill frame near the power cord (see 1. c. above). If the circuit breaker has tripped, wait for five minutes and then press the switch back in.

b. Make sure that the power cord is plugged in.

c. Remove the key from the console. Reinsert the key into the console as far as it will go.

d. Make sure that the on/off switch is in the on position.

e. If the treadmill still will not run, please call our Customer Service Department, toll-free.

PROBLEM: The walking belt slows when walked on

SOLUTION: a. Use only a UL-listed surge protector, rated at 15 amps, with a 14-gauge cord of five feet or less.

b. If the walking belt is overtightened, treadmill performance may decrease and the walking belt may be damaged. Remove the key and **UNPLUG THE POWER CORD**. Using the allen wrench, turn both rear roller adjustment bolts counterclockwise, 1/4 of a turn. When the walking belt is properly tightened, you should be able to lift each side of the walking belt 3 to 4 inches off the walking platform. Be careful to keep the walking belt centered. Plug in the power cord, insert the key and run the treadmill for a few minutes. Repeat until the walking belt is properly tightened.

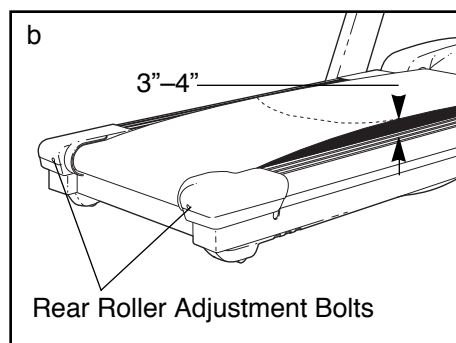

c. If the walking belt still slows when walked on, please call our Customer Service Department, toll-free.

PROBLEM: The walking belt is off-center

SOLUTION: a. If the walking belt has shifted to the left, first remove the key and **UNPLUG THE POWER CORD**. Using the allen wrench, turn the left rear roller adjustment bolt clockwise, and the right bolt counterclockwise, 1/4 of a turn each. Be careful not to overtighten the walking belt. Plug in the power cord, insert the key and run the treadmill for a few minutes. Repeat until the walking belt is centered.

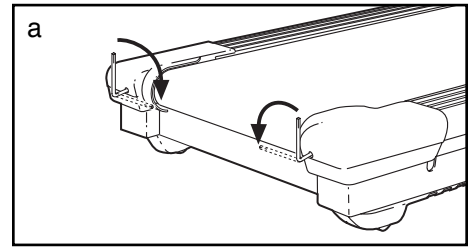

b. If the walking belt has shifted to the right, first remove the key and **UNPLUG THE POWER CORD**. Using the allen wrench, turn the left rear roller adjustment bolt counterclockwise, and the right bolt clockwise, 1/4 of a turn each. Be careful not to overtighten the walking belt. Plug in the power cord, insert the key and run the treadmill for a few minutes. Repeat until the walking belt is centered.

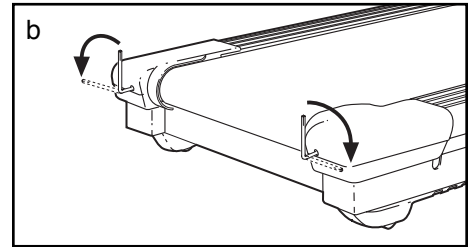

PROBLEM: The walking belt slips when walked on

SOLUTION: a. If the walking belt slips when walked on, first remove the key and **UNPLUG THE POWER CORD**. Using the allen wrench, turn both rear roller adjustment bolts clockwise, 1/4 of a turn. When the walking belt is correctly tightened, you should be able to lift each side of the walking belt 3 to 4 inches off the walking platform. Be careful to keep the walking belt centered. Plug in the power cord, insert the key and carefully walk on the treadmill for a few minutes. Repeat until the walking belt is properly tightened.

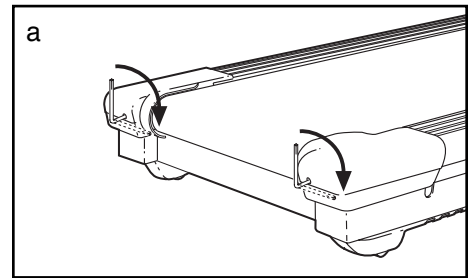

PROBLEM: The heart rate monitor does not function properly

- a. If the heart rate monitor does not function properly, refer to HEART RATE MONITOR TROUBLESHOOTING on page 7.
- b. If the heart rate monitor still does not function properly, the battery should be changed. To replace the battery, locate the battery cover on the back of the sensor unit. Insert a coin into the slot in the cover and turn the cover counterclockwise to the "open" position. Remove the cover.

Next, remove the old battery from the sensor unit. Insert a new **CR 2032 battery**, making sure that the writing is on top. In addition, make sure that the rubber gasket is in place in the sensor unit. Replace the battery cover and turn it to the closed position.

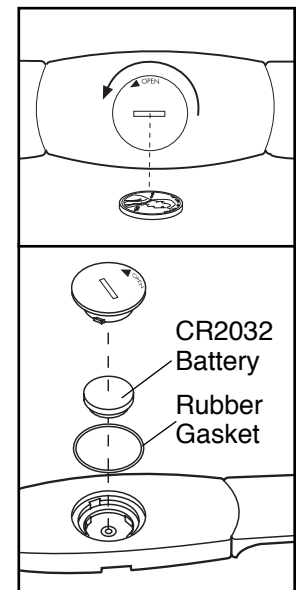

Reebok University was launched in 1993 to fulfill a vision to establish a “university without walls” that develops quality, researched, state-of-the-art fitness programming for the fitness industry throughout the world.

Working with the world’s best professionals, Reebok University has created a host of original programs, such as Step Reebok[®], Walk ReebokSM, Slide ReebokSM and Reebok City JamSM. The industry has adopted Reebok programming as the “gold” standard. Our guidelines and terminology are used by fitness professionals and participants around the world, and our exceptional programming has been approved in the United States by AFAA and ACE for continuing education credits.

WALKING AND CARDIORESPIRATORY ENDURANCE

Scientific studies confirm that walking at a moderate to brisk pace can enhance aerobic fitness. Rippe and his colleagues¹ found that of 500 subjects tested, 67% of the men and 90% of the women were able to reach their target heart rates by walking 4 to 4.5 miles per hour.

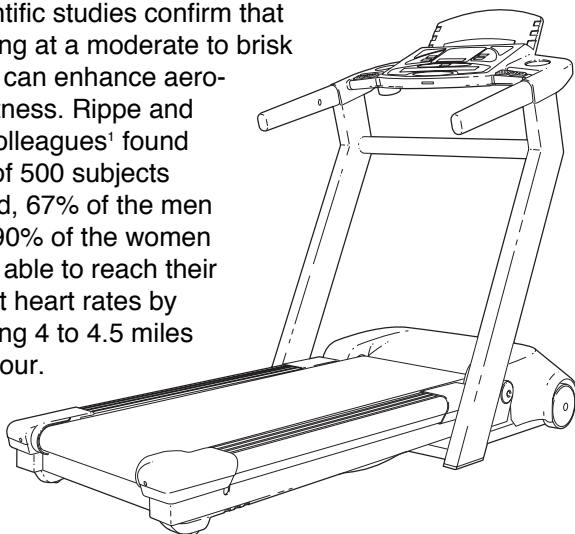

Pollock and his colleagues² found that middle-aged men who walked at a pace of 3.5 to 4.5 miles per hour for 40 minutes four times per week had the same cardiovascular improvements as men the same age who jogged for 30 minutes three times per week. Although the intensity of exercise was lower for the walkers than the runners, the increased duration and frequency of walking provided the walkers with similar aerobic benefits as the runners.

On the basis of current research, it seems clear that walking at a moderate to brisk pace can be an excellent aerobic activity.

WALKING AND REDUCED RISK FOR CARDIOVASCULAR DISEASE

Several studies have found that regular walking at any speed can increase HDL-C cholesterol (a high-density lipoprotein which removes excess cholesterol from the body) and can lower concentrations of blood triglycerides (a storage form of fat), thus reducing the risk for cardiovascular disease.

Duncan and his colleagues³ concluded that exercise does not have to be vigorous to reduce cardiovascular risk factors. In other words, people who choose to stroll rather than walk briskly can reduce their risk for cardiovascular disease.

After studying the physical activity patterns of 17,000 Harvard alumni over a 20-year period, Paffenbarger and his colleagues⁴ concluded that walking as little as five city blocks per day can reduce the risk of cardiovascular disease, and walking 2 miles per day can reduce the risk of a heart attack by 28% or more. Therefore, while walking at a fast pace will improve aerobic fitness, walking at any speed (slow or fast) can reduce a person's risk for heart disease.

WALKING AND WEIGHT REDUCTION

Walking is an excellent activity for burning calories. The steeper the incline and/or the faster the speed, the more calories are burned. For example, a 150-pound person walking at 3.5 miles per hour on flat ground will burn about 300 calories per hour. This same person will burn 400 calories per hour on a gentle 4% incline and 500 calories per hour on a steeper 10% incline. If this person speeds the pace up to 4 miles per hour on level ground, 350 calories will be burned in one hour.⁵

It should be noted that participants who do not wish to walk at faster speeds can burn a comparable number of calories by walking for longer periods of time.

WALKING AND BONE DENSITY

Osteoporosis is a major health problem in the United States, affecting an estimated 15 to 30 million people. An age-related disorder, osteoporosis reduces the density of bones. This disease can be life-threatening since many older people die as a result of complications suffered from broken bones. Adequate calcium in the diet and weight-bearing exercises seem to reduce the risk of osteoporosis.

Several studies have reported that regular walking at moderate to brisk speeds appears to increase bone density. Specifically, Fradin and his colleagues⁶ found that 70-year-old subjects who walked at least 30 minutes per day had higher bone mineral content than subjects who walked less than 30 minutes per day. Jones and his colleagues⁷ reported that sedentary women (aged 30 to 61 years old) who began a regular walking program and continued for one year increased their bone density.

Since walking can be comfortably performed by people of any age, walking appears to be practical and effective in reducing a person's risk for developing osteoporosis.

WALKING AND STRESS REDUCTION

There are many stressors in today's society, including economic concerns, work-related pressures and the need to balance career goals with home responsibilities. People who are unable to cope with these types of stressors are often tense and anxious, and may even become physically or psychologically ill.

Researchers have found that exercise is one way to help people reduce stress. For example, subjects who engaged in a regular aerobic conditioning program and who altered their diets experienced significant gains in self-concept, feelings of well-being and reduced depression.⁸

Cramer and his colleagues⁹ specifically examined the effect of brisk walking on mildly obese sedentary women and found that walking improved general psychological well-being. Walking therefore appears to be an effective tool for improving psychological well-being.

WALKING AND INJURIES

Walking is often associated with a low injury rate. Walking is considered to be a "low impact" activity because one foot remains in contact with the ground at all times. Walking at speeds of 3 miles per hour produces vertical impact forces that are around 1.25 times body weight, whereas running at 7 miles per hour increases vertical impact forces to more than 2.5 times body weight.

During a 24-week study, not one of 59 participants who walked five days a week at speeds between 3 and 5 miles per hour sustained a walking-related injury that necessitated consulting with a physician. Carroll and his colleagues¹⁰ reported that 14% of the elderly subjects participating in a walking study suffered training-related orthopedic injuries, mostly to the lower leg and foot. The majority of injuries occurred in the group assigned to "fast walking."

It is important to note that all forms of exercise have some degree of risk associated with the activity. Generally, the less mechanical stress on the musculoskeletal system, the less risk of becoming injured. Because of the low-impact nature of walking, the incidence of injury appears to be low when compared to other high-impact activities.

REFERENCES

1. Rippe, J., Ross, J., et. al. "Cardiovascular effects of walking." (Abstract), Proceedings of the Second International Conference on Physical Activity, Aging and Sports, July, 1985, p. 47.
2. Pollock, M., Miller, H. Jr., et. al. "Effects of walking on body composition and cardiovascular function of middle-aged men." *Journal of Applied Physiology*, 1971, 30:126-130.
3. Duncan, J., Gordon, N., et. al. "Women walking for health and fitness. How much is enough?" *Journal of the American Medical Association*, 1991, 266(23):3295-9.
4. Paffenbarger, R., Hyde, R., et.al. "Physical activity, all-cause mortality and longevity of college alumni." *New England Journal of Medicine*, 1986, 314:605-613.
5. "Better walking workouts." University of California at Berkeley Wellness Letter, 1992, 8(12):4-5.
6. Fradin, K. Grimby, G., et. al. "Walking habits and health-related factors in a 70-year-old population," *Gerontology*, 1991, 37(5):281-8.
7. Jones, P., Hardman, A., et. al. "Influence of brisk walking on the broadband ultrasonic attenuation of the calcaneus in previously sedentary women aged 30-61 years." *Calcified Tissue International*, 1991, 49(2):112-5.
8. Blair, S., Collingwood, T., et. al. "Health Promotion for Educators: Impact on Health Behaviors, Satisfaction, and General Well-Being," *American Journal of Public Health*, 1984, 74:147-49.
9. Cramer, S., Nieman D., et. al. "The effects of moderate exercise training on psychological well-being and mood state in women." *Journal of Psychosomatic Research*, 1991, 35(4-5):437-49.
10. Carroll, J., Pollack, M., et. al. "Incidence of injury during moderate and high intensity walking in the elderly." *Journal of Gerontology*, 1992, 47(3):M61-6.

EXERCISE GUIDELINES

⚠ WARNING: Before beginning this or any exercise program, consult your physician. This is especially important for individuals over the age of 35 or individuals with pre-existing health problems.

The heart rate monitor is not a medical device. Various factors, including the user's movement, may affect the accuracy of heart rate readings. The heart rate monitor is intended only as an exercise aid in determining heart rate trends in general.

The following guidelines will help you to plan your exercise program. Remember—these are general guidelines only. For more detailed exercise information, obtain a reputable book or consult your physician.

EXERCISE INTENSITY

Whether your goal is to burn fat or to strengthen your cardiovascular system, the key to achieving the desired results is to exercise with the proper intensity. The proper intensity level can be found by using your heart rate as a guide. The chart below shows recommended heart rates for fat burning and aerobic exercise.

	♥	165	155	145	140	130	125	115
♥		145	138	130	125	118	110	103
♥		125	120	115	110	105	95	90
		20	30	40	50	60	70	80

To find the proper heart rate for you, first find your age near the bottom of the chart (ages are rounded off to the nearest ten years). Next, find the three numbers above your age. The three numbers define your “training zone.” The lower two numbers are recommended heart rates for fat burning; the higher number is the recommended heart rate for aerobic exercise.

You can measure your heart rate using the heart rate monitor. If your heart rate is too high or too low, adjust the speed or incline of the treadmill accordingly.

Fat Burning

To burn fat effectively, you must exercise at a relatively low intensity level for a sustained period of time.

During the first few minutes of exercise, your body uses easily accessible carbohydrate calories for energy. Only after the first few minutes does your body begin to use stored fat calories for energy. If your goal is to burn fat, adjust the speed or incline of the treadmill until your heart rate is near the lowest number in your training zone.

For maximum fat burning, adjust the speed or incline of the treadmill until your heart rate is near the middle number in your training zone.

Aerobic Exercise

If your goal is to strengthen your cardiovascular system, your exercise must be “aerobic.” Aerobic exercise is activity that requires large amounts of oxygen for prolonged periods of time. This increases the demand on the heart to pump blood to the muscles and on the lungs to oxygenate the blood. For aerobic exercise, adjust the speed or incline of the treadmill until your heart rate is near the highest number in your training zone.

WORKOUT GUIDELINES

Each workout should include the following three parts:

A Warm-up—Start each workout with 5 to 10 minutes of stretching and light exercise. A proper warm-up increases your body temperature, heart rate and circulation in preparation for exercise.

Training Zone Exercise—After warming up, increase the intensity of your exercise until your heart rate is in your training zone for 20 to 60 minutes. (During the first few weeks of your exercise program, do not keep your heart rate in your training zone for longer than 20 minutes.) Breathe regularly and deeply as you exercise—never hold your breath.

A Cool-down—Finish each workout with 5 to 10 minutes of stretching to cool down. This will increase the flexibility of your muscles and will help prevent post-exercise problems.

Exercise Frequency

To maintain or improve your condition, complete three workouts each week, with at least one day of rest between workouts. After a few months, you may complete up to five workouts each week if desired.

SUGGESTED STRETCHES

The correct form for several basic stretches is shown at the right. Move slowly as you stretch—never bounce.

1. Toe Touch Stretch

Stand with your knees bent slightly and slowly bend forward from your hips. Allow your back and shoulders to relax as you reach down toward your toes as far as possible. Hold for 15 counts, then relax. Repeat 3 times. Stretches: Hamstrings, back of knees and back.

2. Hamstring Stretch

Sit with one leg extended. Bring the sole of the opposite foot toward you and rest it against the inner thigh of your extended leg. Reach toward your toes as far as possible. Hold for 15 counts, then relax. Repeat 3 times for each leg. Stretches: Hamstrings, lower back and groin.

3. Calf/Achilles Stretch

With one leg in front of the other, reach forward and place your hands against a wall. Keep your back leg straight and your back foot flat on the floor. Bend your front leg, lean forward and move your hips toward the wall. Hold for 15 counts, then relax. Repeat 3 times for each leg. To cause further stretching of the achilles tendons, bend your back leg as well. Stretches: Calves, achilles tendons and ankles.

4. Quadriceps Stretch

With one hand against a wall for balance, reach back and grasp one foot with your other hand. Bring your heel as close to your buttocks as possible. Hold for 15 counts, then relax. Repeat 3 times for each leg. Stretches: Quadriceps and hip muscles.

5. Inner Thigh Stretch

Sit with the soles of your feet together and your knees outward. Pull your feet toward your groin area as far as possible. Hold for 15 counts, then relax. Repeat 3 times. Stretches: Quadriceps and hip muscles.

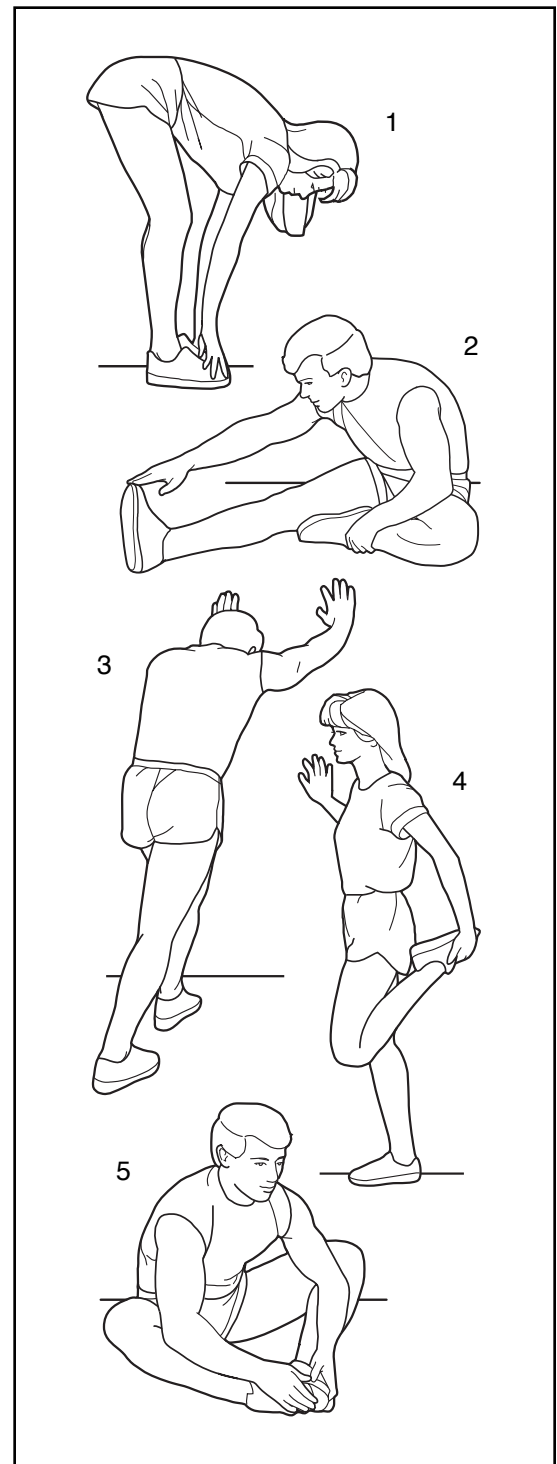

To locate the parts listed below, refer to the EXPLODED DRAWING attached in the center of this manual.

Key No.	Qty.	Description	Key No.	Qty.	Description
1	2	Foot Rail	51	1	Optic Switch
2	1	Front Roller Nut	52	1	Small Nut
3	1	Front Left Endcap	53	1	Right Foam Grip
4	1	Key/Clip	54	4	Motor Nut
5	2	Frame Pivot Spacer	55	1	Pulley/Flywheel/Fan
6	1	Front Roller/Pulley	56	1	Motor
7	8	Platform Screw	57	2	Upright Grommet
8	2	Belt Guide	58*	1	Motor/Pulley/Flywheel/Fan
9	2	Caution Decal	59	1	Optic Disc
10	8	Isolator Spacer Screw	60	1	Sensor Wire
11	4	Isolator	61	4	Hood Fastener
12	4	Isolator Spacer	62	1	Motor Hood
13	1	Walking Belt	63	1	Controller
14	1	Walking Platform	64	37	Electronics Screw
15	1	Storage Knob Screw	65	1	Power Supply
16	1	Storage Knob Shaft	66	4	Plastic Stand-Off
17	1	Storage Pin	67	2	Hood Bracket
18	1	Spring Clip	68	1	Electronics Plate
19	1	Spring Clip Screw	69	1	Hood Support
20	1	Storage Knob	70	1	Motor Adj. Bolt
21	1	Frame	71	1	Lift Frame
22	2	Rear Roller Adj. Screw	72	2	Small Hood Bracket
23	3	Roller Adj. Washer	73	1	Chest Strap
24	1	Right Rear Endcap	74	1	Motor Isolator Plate
25	1	8" Cable Tie	75	4	Motor Bolt
26	1	4" Cable Tie	76	4	Motor Isolator
27	1	Releasable Wire Tie	77	5	Incline Motor Nut
28	1	Wire Tie Screw	78	2	Incline Motor Bolt
29	1	Tie Clamp	79	1	Front Roller Adj. Bolt
30	1	Belly Pan	80	1	Allen Wrench
31	1	Latch Decal	81	1	Reed Switch
32	2	Rear Wheel	82	1	Incline Motor
33	4	Platform Screw (Front)	83	1	Front Belly Pan
34	4	Rear Wheel Bolt/Frame Bolt	84	1	Power Cord
35	12	Belly Pan Fastener	85	1	On/Off Switch
36	1	Front Right Endcap	86	1	Circuit Breaker
37	1	Ground Screw	87	1	Power Cord Grommet
38	1	Ground Wire	88	1	Incline Motor Shield
39	1	Upright/Base	89	2	Front Wheel Bolt
40	1	Left Foam Grip	90	2	Front Wheel
41	29	Screw	91	4	Bumper Screw
42	2	Left Pulse Pad	92	4	Bumper
43	2	Right Pulse Pad	93	2	Grommet
44	1	Console Base (top)	94	1	Wire Harness
45	1	Motor Belt (bottom)	95	1	Shock
46	1	Console Base	96	6	Wheel Nut
47	2	Motor Tension Bolt	97	2	Upright Cap
48	6	Small Screw	98	2	Upright Endcap
49	1	Small Bolt	99	4	Upright Endcap Screw
50	1	Star Washer	100	1	Left Rear Endcap

Key No.	Qty.	Description	Key No.	Qty.	Description
101	2	Nylon Washer	119	1	Receiver Bracket
102	2	Incline Spacer	120	2	Wheel Sleeve
103	1	Console	#	1	8" Blue Wire, 2 F
104	2	Motor Tension Washer	#	1	8" Blue Wire, M/F
105	1	Motor Star Washer	#	1	14" White Wire, 2 F
106	1	Motor Pivot Bolt	#	1	8" White Wire, M/F
107	1	Sensor Unit	#	1	8" Red Wire, M/F
108	1	Motor Bracket	#	1	9" Wire M/F
109	4	Motor Tension Nut	#	1	4" Black Wire , 2 F
110	1	Motor Adj. Nut	#	1	8" Green Wire, F/Ring
111	8	Console Screw	#	1	20" Wire Harness
112	1	Optic Switch Bracket	#	1	User's Manual
113	1	Reading Rack			
114	1	8" Wire Harness	* Includes all parts shown in the box		
115	1	Rear Roller	# These parts are not illustrated		
116	1	Front Belly Pan			
117	1	Sensor Foam			
118	1	Pulse Receiver	Specifications are subject to change without notice		

HOW TO ORDER REPLACEMENT PARTS

To order replacement parts, call our Customer Service Department toll-free at 1-800-999-3756, Monday through Friday, 6 a.m. until 6 p.m. Mountain Time (excluding holidays). To help us assist you, please be prepared to give the following information:

- The MODEL NUMBER of the product (RBTL15980)
- The NAME of the product (REEBOK® ACD3 treadmill)
- The SERIAL NUMBER of the product (see the front cover of this manual)
- The KEY NUMBER and DESCRIPTION of the part(s) (see the PART LIST on pages 26 and 27 and the EXPLODED DRAWING attached in the center of the manual).

EXPLODED DRAWING—MODEL NO. RBTL15980

R1198A

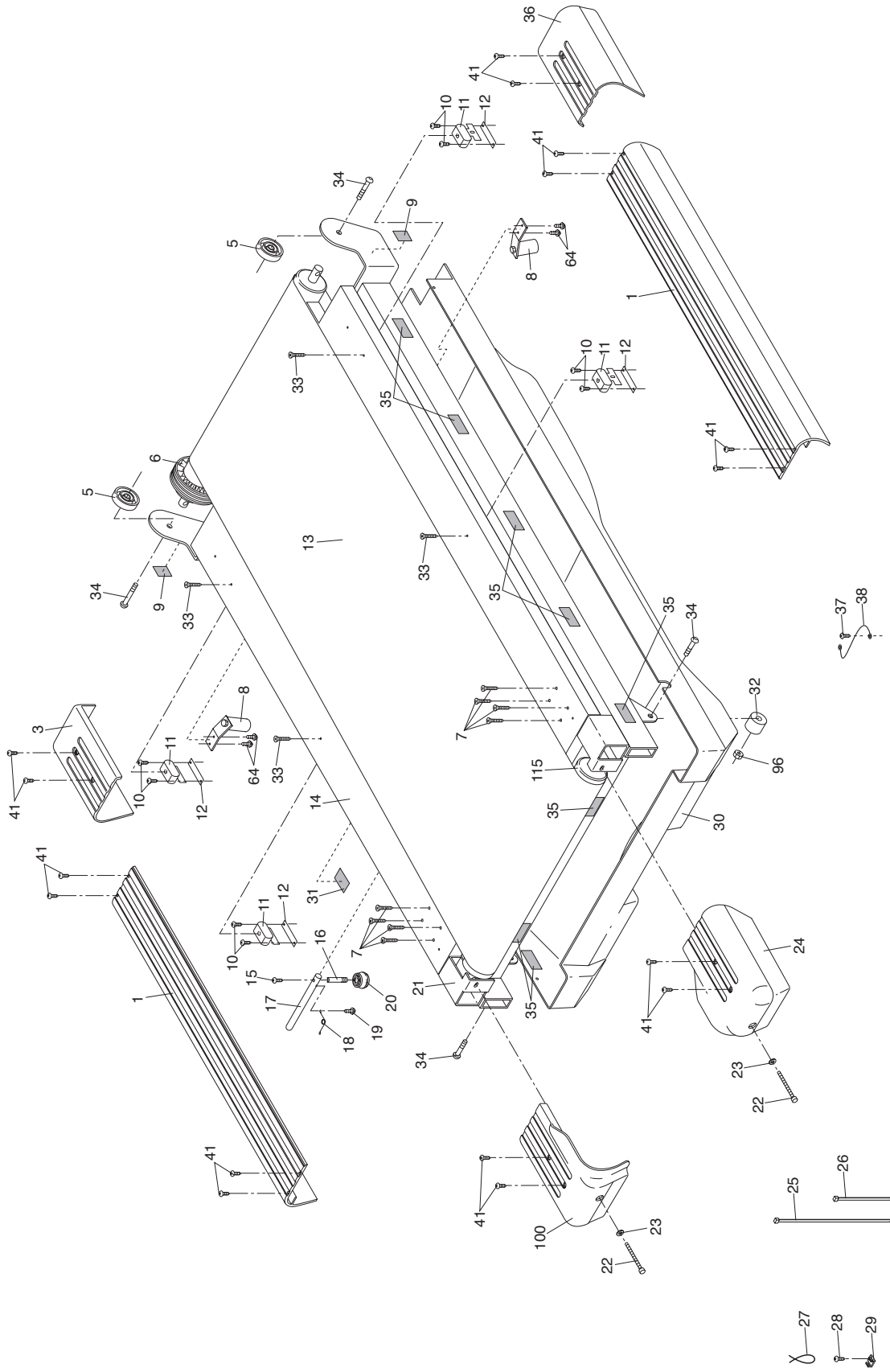

EXPLODED DRAWING—MODEL NO. RBTL15980

R1198A

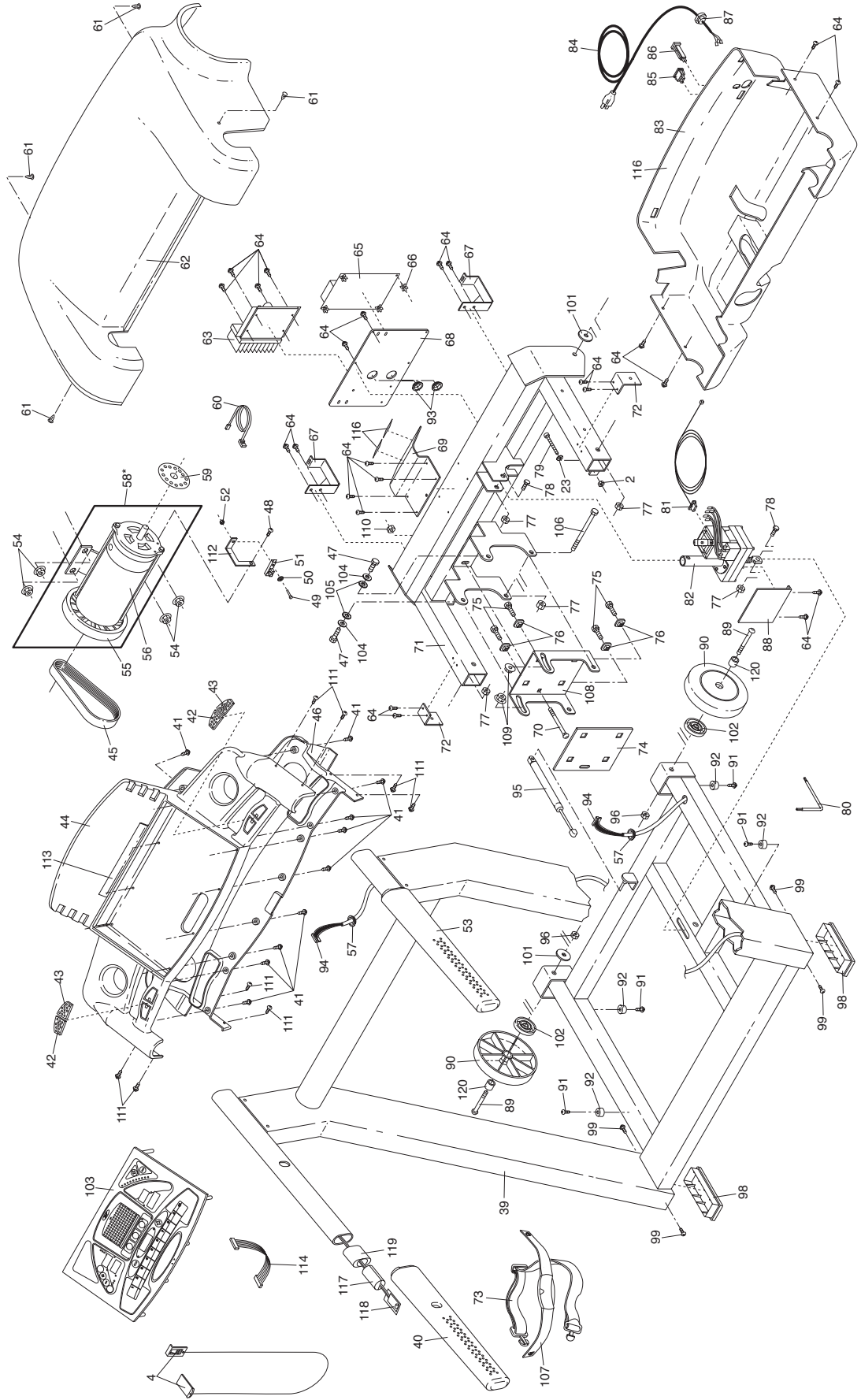

LIMITED WARRANTY

WHAT IS COVERED—The entire REEBOK® ACD3 (“Product”) is warranted to be free of all defects in material and workmanship.

WHO IS COVERED—The original purchaser or any person receiving the Product as a gift from the original purchaser.

HOW LONG IS IT COVERED—ICON Health & Fitness, Inc. (“ICON”), warrants the hood, covers, belly pan, and decals for six months after the date of purchase. The motor is covered for three years after the date of purchase. The belt and deck are covered for two years after the date of purchase. All mechanical components are covered for two years after the date of purchase. All electrical components are covered for two years after the date of purchase. Labor is covered for one year.

WHAT WE DO TO CORRECT COVERED DEFECTS—We will ship to you, without charge, any replacement part or component, providing the repairs are authorized by ICON first and are performed by an ICON trained and authorized service provider, or, at our option, we will replace the Product.

WHAT IS NOT COVERED—Any failures or damage caused by unauthorized service, misuse, accident, negligence, improper assembly or installation, alterations, modifications without our written authorization or by failure on your part to use, operate, and maintain as set out in your User’s Manual (“Manual”).

WHAT YOU MUST DO—Always retain proof of purchase, such as your bill of sale; store, operate, and maintain the Product as specified in the Manual; notify our Customer Service Department of any defect within 10 days after discovery of the defect; as instructed, return any defected part for replacement or, if necessary, the entire product, for repair.

USER’S MANUAL—It is VERY IMPORTANT THAT YOU READ THE MANUAL before operating the Product. Remember to do the periodic maintenance requirements specified in the Manual to assure proper operation and your continued satisfaction.

HOW TO GET PARTS AND SERVICE—Simply call our Customer Service Department at 1-800-999-3756 and tell them your name and address and the serial number of your Product. They will tell you how to get a part replaced, or if necessary, arrange for service where your Product is located or advise you how to ship the Product for service. Before shipping, always obtain a Return Authorization Number (RA No.) from our Customer Service Department; securely pack your Product (save the original shipping carton if possible); put the RA No. on the outside of the carton and insure the product. Include a letter explaining the product or problem and a copy of your proof of purchase if you believe the service is covered by warranty.

ICON is not responsible or liable for indirect, special or consequential damages arising out of or in connection with the use or performance of the product or damages with respect to any economic loss, loss of property, loss of revenues or profits, loss of enjoyment or use, costs of removal, installation or other consequential damages of whatsoever nature. Some states do not allow the exclusion or limitation of incidental or consequential damages. Accordingly, the above limitation may not apply to you.

The warranty extended hereunder is in lieu of any and all other warranties and any implied warranties of merchantability or fitness for a particular purpose is limited in its scope and duration to the terms set forth herein. Some states do not allow limitations on how long an implied warranty lasts. Accordingly, the above limitation may not apply to you.

No one is authorized to change, modify or extend the terms of this limited warranty.

This warranty gives you specific legal rights and you may have other rights which vary from state to state.

ICON HEALTH & FITNESS, INC., 1500 S. 1000 W., LOGAN, UT 84321-9813

REEBOK and the Vector Logo  are registered trademarks and service marks of Reebok. This product is manufactured and distributed under license from Reebok International.

Free Manuals Download Website

<http://myh66.com>

<http://usermanuals.us>

<http://www.somanuals.com>

<http://www.4manuals.cc>

<http://www.manual-lib.com>

<http://www.404manual.com>

<http://www.luxmanual.com>

<http://aubethermostatmanual.com>

Golf course search by state

<http://golfingnear.com>

Email search by domain

<http://emailbydomain.com>

Auto manuals search

<http://auto.somanuals.com>

TV manuals search

<http://tv.somanuals.com>