



Everywhere you imagine.

REG10J0131-0100

Renesas Starter Kit for H8SX/1668R

User's Manual

RENEASAS SINGLE-CHIP MICROCOMPUTER
H8SX FAMILY

Rev.1.00
Revision date: 04.APR.2008

Renesas Technology Europe Ltd.
www.renesas.com

Table of Contents

Chapter 1. Preface	3
Chapter 2. Purpose	4
Chapter 3. Power Supply.....	5
3.1. Requirements.....	5
3.2. Power – Up Behaviour	5
Chapter 4. Board Layout	6
4.1. Component Layout.....	6
4.2. Board Dimensions.....	7
Chapter 5. Block Diagram	8
Chapter 6. User Circuitry.....	10
6.1. Switches.....	10
6.2. LEDs	10
6.3. Potentiometer.....	10
6.4. Serial port.....	10
6.5. Debug LCD Module.....	11
6.6. Option Links	11
6.7. Oscillator Sources.....	17
6.8. Reset Circuit.....	17
6.9. USB port.....	18
Chapter 7. Modes	19
7.1. Boot mode.....	19
7.2. Single chip mode	19
Chapter 8. Programming Methods	20
Chapter 9. Headers	21
9.1. Microcontroller Headers.....	21
9.2. Application Headers	25
Chapter 10. Code Development.....	28
10.1. Overview	28
10.2. Compiler Restrictions	28
10.3. Mode Support.....	28
10.4. Breakpoint Support	28
10.5. Memory Map	29
Chapter 11. Component Placement	30
Chapter 12. Additional Information	31

Chapter 1. Preface

Cautions

This document may be, wholly or partially, subject to change without notice.

All rights reserved. Duplication of this document, either in whole or part is prohibited without the written permission of Renesas Technology Europe Limited.

Trademarks

All brand or product names used in this manual are trademarks or registered trademarks of their respective companies or organisations.

Copyright

© Renesas Technology Europe Ltd. 2008. All rights reserved.

© Renesas Technology Corporation. 2008. All rights reserved.

© Renesas Solutions Corporation. 2008. All rights reserved.

Website: <http://www.renesas.com/>

Glossary

CPU	Central Processing Unit	HEW	High-performance Embedded Workshop
LED	Light Emitting Diode	RSK	Renesas Starter Kit
PC	Program Counter	E10A FSK	On-chip debugger module
LCD	Liquid Crystal Display	DAC	Digital-to-Analog Converter

Chapter 2. Purpose

This RSK is an evaluation tool for Renesas microcontrollers.

This manual describes the technical details of the RSK hardware. The Quick Start Guide and Tutorial Manual provide details of the software installation and debugging environment.

Features include:

- Renesas Microcontroller Programming.
- User Code Debugging.
- User Circuitry such as Switches, LEDs and potentiometer.
- User or Example Application.
- Sample peripheral device initialisation code.

The RSK board contains all the circuitry required for microcontroller operation.

Chapter 3. Power Supply

3.1. Requirements

This RSK operates from a 5V power supply.

A diode provides reverse polarity protection only if a current limiting power supply is used.

All RSK boards are supplied with an E10A debugger.

All RSK boards have an optional centre positive supply connector using a 2.0mm barrel power jack.

Warning

The RSK is neither under nor over voltage protected. Use a centre positive supply for this board.

3.2. Power – Up Behaviour

When the RSK is purchased the RSK board has the 'Release' or stand alone code from the example tutorial code pre-programmed into the Renesas microcontroller. On powering up the board the user LEDs will start to flash. After 200 flashes, or after pressing a switch the LEDs will flash at a rate controlled by the potentiometer.

Chapter 4. Board Layout

4.1. Component Layout

The following diagram shows top layer component layout of the board.

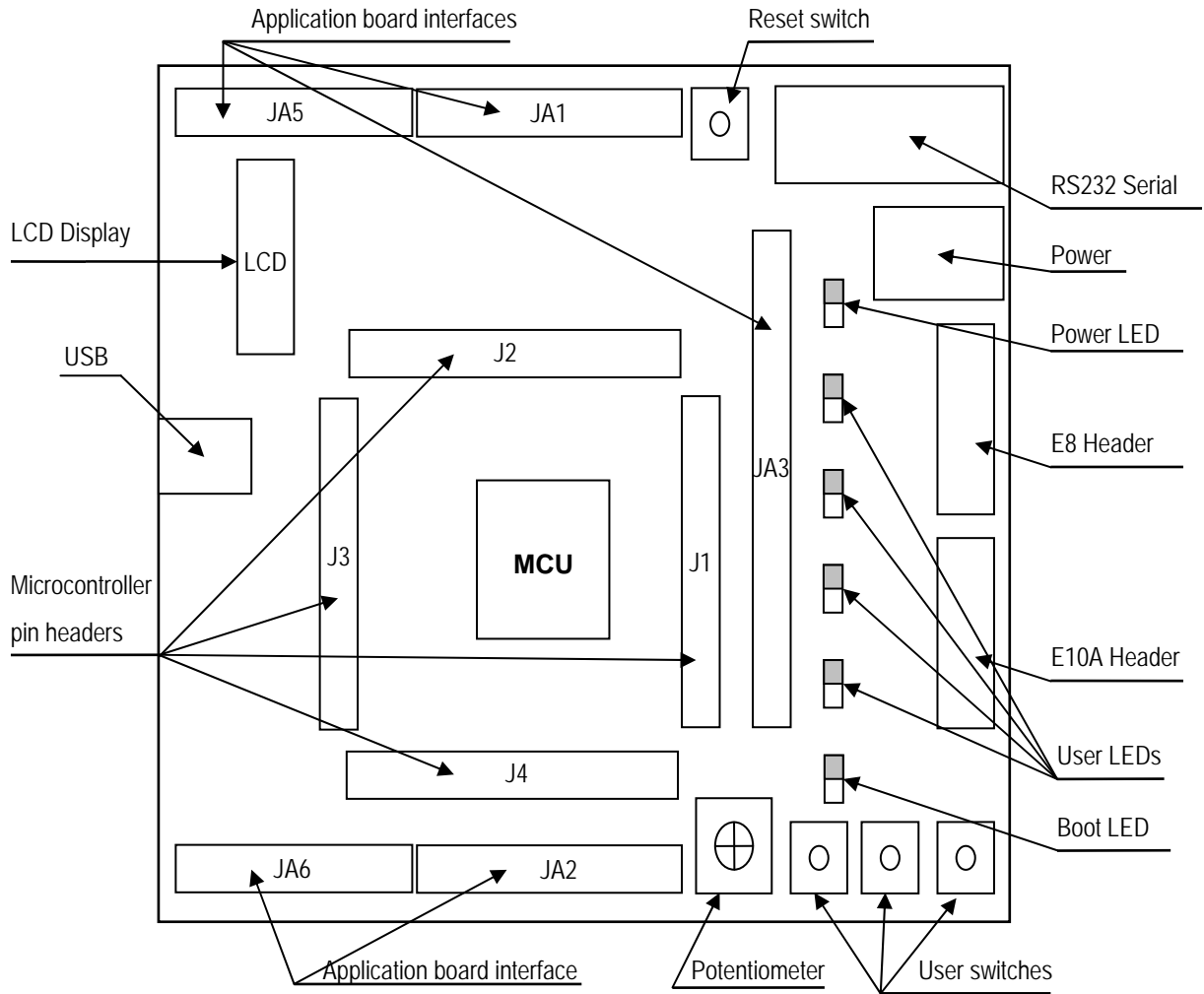

Figure 4-1: Board Layout

4.2. Board Dimensions

The following diagram gives the board dimensions and connector positions. All through hole connectors are on a common 0.1" grid for easy interfacing.

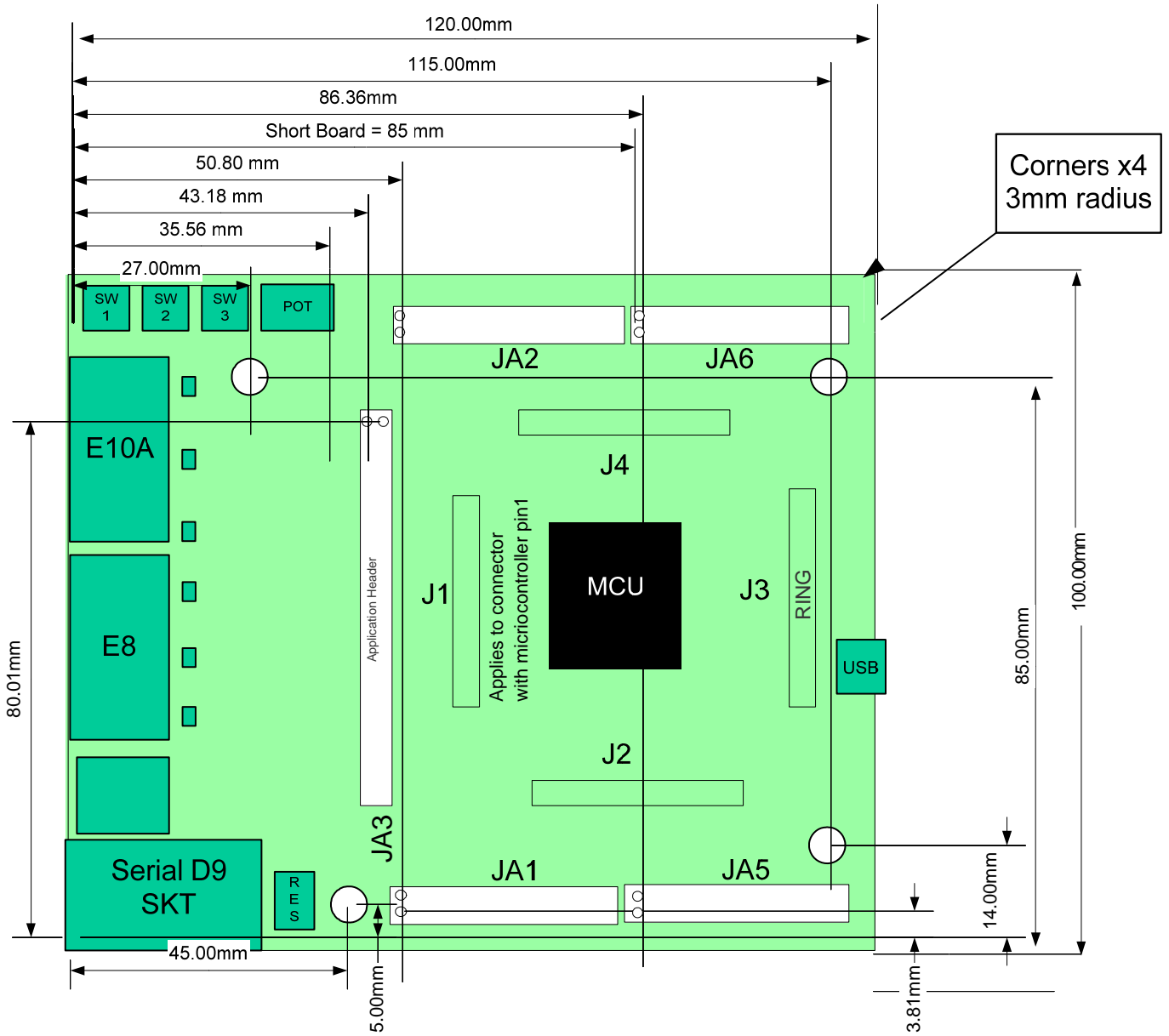

Figure 4-2: Board Dimensions

Chapter 5. Block Diagram

Figure 5-1 shows the CPU board components and their connectivity.

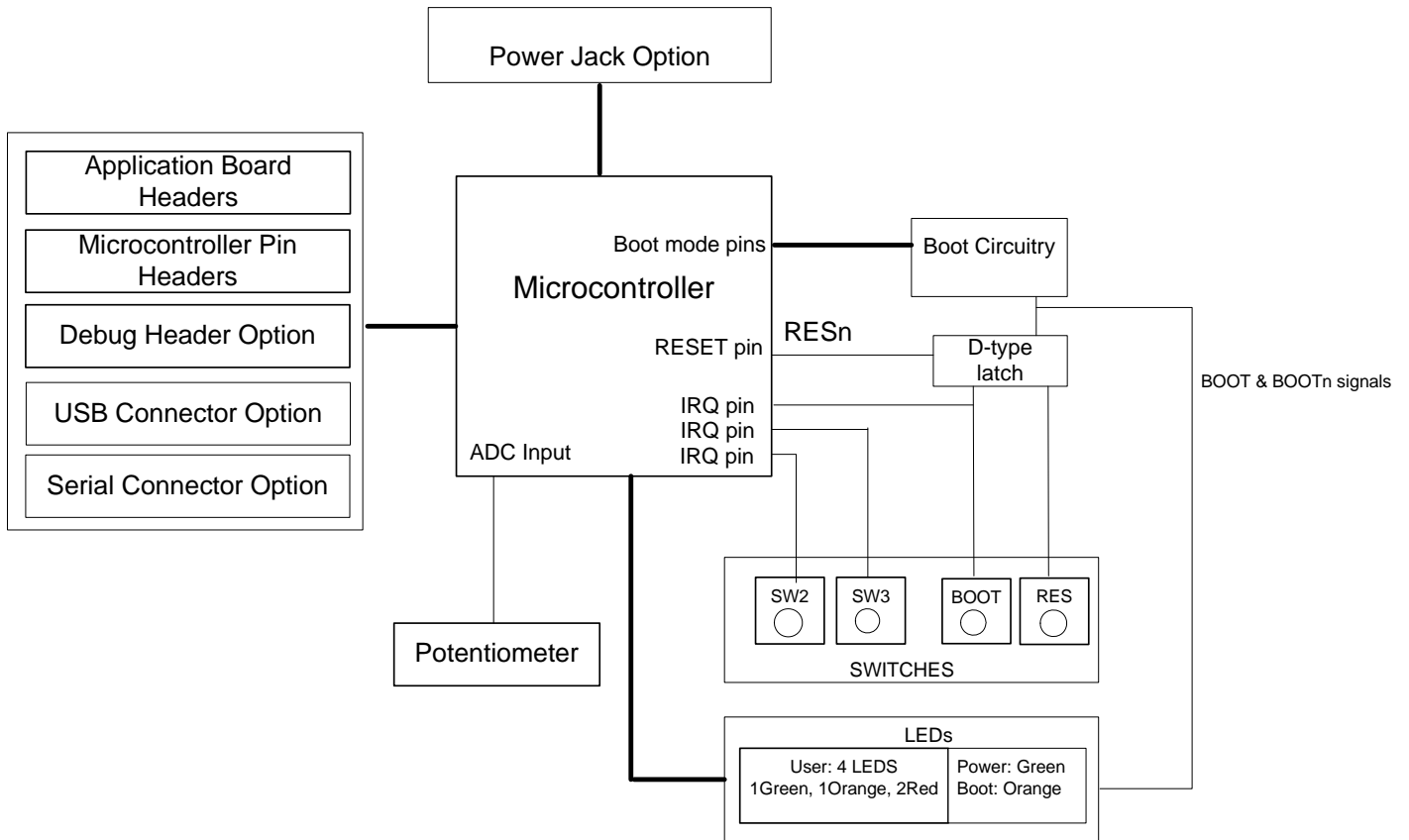

Figure 5-1: Block Diagram

Figure 5-2 shows the connections to the RSK.

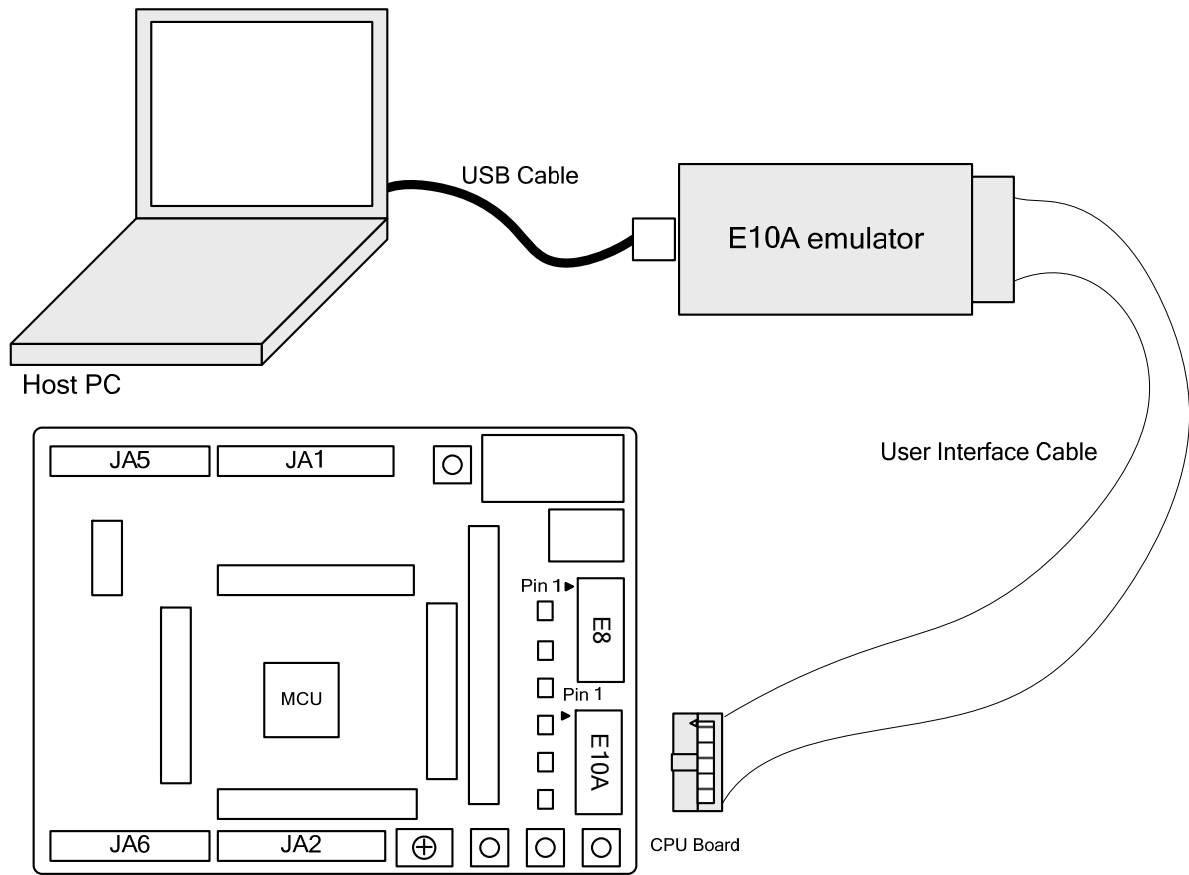

Figure 5-2: RSK Connections

Chapter 6. User Circuitry

6.1. Switches

There are four switches located on the CPU board. The function of each switch and its connection are shown in Table 6-1.

Switch	Function	Microcontroller
RES	When pressed, the RSK microcontroller is reset.	RESn, Pin 91
SW1/BOOT*	Connects to an IRQ input for user controls. The switch is also used in conjunction with the RES switch to place the device in BOOT mode when not using the E10A debugger.	IRQ0n, Pin 84 (Port 1 pin 0)
SW2*	Connects to an IRQ line for user controls.	IRQ1n, Pin 85 (Port 1, pin 1)
SW3*	Connects to the ADC trigger input. Option link allows connection to IRQ line. The option is a pair of OR links. For more details on option links, please refer to Sec 6.6.	IRQ3n_ADTRGn, Pin 87 (Port 1, pin 3)

Table 6-1: Switch Functions

*Refer to schematic for detailed connectivity information.

6.2. LEDs

There are six LEDs on the RSK board. The green 'POWER' LED lights when the board is powered. The orange BOOT LED indicates the device is in BOOT mode when lit. The four user LEDs are connected to an IO port and will light when their corresponding port pin is set low.

Table 6-2, below, shows the LED pin references and their corresponding microcontroller port pin connections.

LED Reference (As shown on silkscreen)	Colour	Microcontroller Port Pin function	Microcontroller Pin Number
LED0	Green	Port B.3	3
LED1	Orange	Port C.2	116
LED2	Red	Port C.3	117
LED3	Red	Port 1.2	86

Table 6-2: LED Port

6.3. Potentiometer

A single turn potentiometer is connected to channel AN0 (P5.0, pin 118) of the microcontroller. This may be used to vary the input analog voltage value to this pin between AVCC and Ground.

6.4. Serial port

Serial port SCI0 is connected to the standard RS232 header. Serial port SCI5 can optionally be connected to the RS232 header. The connections to be fitted are listed in the Table 6-3.

Description	Function	Circuit Net Name	CPU's Pin	Fit for RS232	Remove for RS232
SCI0	Default serial port	TXD0	52	R31	R37
SCI0	Default serial port	RXD0	51	R30	R36
SCI5	Spare Serial Port	TXD5	93	R34, R15	-
SCI5	Spare Serial Port	RXD5	94	R35, R28	-

Table 6-3: Serial Port settings

The SCI0 port is also available on J2 and JA2 (R59 and R70 must be fitted) headers. The SCI5 port is available on J3 and JA6 headers..

6.5. Debug LCD Module

A debug LCD module is supplied to be connected to the connector marked 'LCD', so that the debug LCD module lies over J2. Care should be taken to ensure the pins are inserted correctly into LCD. The debug LCD module uses a 4 bit interface to reduce the pin allocation. No contrast control is provided; this is set by a resistor on the supplied display module. The module supplied with the RSK only supports 5V operation.

Table 6-4 shows the pin allocation and signal names used on this connector.

LCD					
Pin	Circuit Net Name	Device Pin	Pin	Circuit Net Name	Device Pin
1	Ground	-	2	5V Only	-
3	No Connection	-	4	DLCDRS (PA0)	134
5	R/W (Wired to Write only)	-	6	DLCDE + 100k pull down to ground (PA2)	136
7	No Connection	-	8	No connection	-
9	No Connection	-	10	No connection	-
11	DLCDD4 (PB4)	130	12	DLCDD5 (PB5)	131
13	DLCDD6 (PB6)	132	14	DLCDD7 (PB7)	5

Table 6-4 Debug LCD Module Connections

6.6.Option Links

Table 6-5 below describes the function of the option links contained on this RSK board and associated with Serial Port Configuration. The default configuration is indicated by **BOLD** text.

Option Link Settings				
Reference	Function	Fitted	Alternative (Removed)	Related To
R15	Serial Port Configuration	Connects serial port SCI5 (Tx) to D-type connector (J8).	Disconnects serial port SCI5 (Tx) from D-type connector (J8).	R28, R34, R35
R19	Serial Port configuration	Disables RS232 Serial Transceiver	Enables RS232 Serial Transceiver	-
R28	Serial Port Configuration	Connects serial port SCI5 (Rx) to D-type connector (J8).	Disconnects serial port SCI5 (Rx) from D-type connector (J8).	R15, R34, R35
R30	Serial Port Configuration	Routes on-board serial port to SCI0 (Rx) microcontroller pin.	Disconnects on-board serial port from the CPU's SCI0 (Rx) pin.	R31, R32, R33, R36, R37
R31	Serial Port Configuration	Routes on-board serial port to SCI0 (Tx) microcontroller pin.	Disconnects on-board serial port from the CPU's SCI0 (Tx) pin.	R30, R32, R33, R36, R37
R32	Serial Port Configuration	Routes serial port SCI0 (Tx) to JA6 header.	Disconnects serial port SCI0 (Tx) from JA6 header.	R30, R31, R33
R33	Serial Port Configuration	Routes serial port SCI0 (Rx) to JA6 header.	Disconnects serial port SCI0 (Rx) from JA6 header.	R30, R31, R32
R34	Serial Port Configuration	Routes on-board serial port to SCI5 (Tx) microcontroller pin.	Disconnects on-board serial port from SCI5 (Tx) CPU pin.	R15, R28, R35
R35	Serial Port Configuration	Routes on-board serial port to SCI5 (Rx) microcontroller pin.	Disconnects on-board serial port from SCI5 (Rx) CPU pin.	R15, R28, R34
R36	Serial Port Configuration	Connects PTRX of programming port to the on-board serial port (J8).	Disconnects programming port PTRX from the on-board serial port (J8).	R37, R31, R30
R37	Serial Port Configuration	Connects PTTX of programming port to the on-board serial port (J8).	Disconnects programming port PTTX from the on-board serial port (J8).	R36, R30, R31

Table 6-5: Serial port configuration links.

Table 6-6 below describes the function of the option links associated with application board interface. The default configuration is indicated by BOLD text.

Option Link Settings				
Reference	Function	Fitted	Alternative (Removed)	Related To
R68	Application board interface	Use DA0 of application board interface.	Use AN6 of application board interface.	R108
R108	Application board interface	Use AN6 of application board interface.	Use DA0 of application board interface.	R68

Option Link Settings				
Reference	Function	Fitted	Alternative (Removed)	Related To
R71	Application board interface	Use DA1 of application board interface.	Use AN7 of application board interface.	R111
R111	Application board interface	Use AN7 of application board interface.	Use DA1 of application board interface.	R71
R60	Application board interface	Use AN0 of application board interface.	Use ADPOT of application board interface.	R96
R96	Application board interface	Use ADPOT of application board interface.	Use AN0 of application board interface.	R60
R95	Application board interface	Use IRQ3n of application board interface.	Use ADTRG of application board interface.	R56
R56	Application board interface	Use ADTRGn of application board interface.	Use IRQ3n of application board interface.	R95
R114	Application board interface	Use TIOCA2 of application board interface.	Use Up of application board interface.	R69
R69	Application board interface	Use Up of application board interface.	Use TIOCA2 of application board interface.	R114
R116	Application board interface	Use TIOCB2 of application board interface.	Use Un of application board interface.	R115
R115	Application board interface	Use Un of application board interface.	Use TIOCB2 of application board interface.	R116
R81	Application board interface	Use TIOCA0 of application board interface	Use Vp of application board interface	R75
R75	Application board interface	Use Vp of application board interface	Use TIOCA0 of application board interface	R81
R90	Application board interface	Use TIOCB0 of application board interface	Use Vn of application board interface	R84
R84	Application board interface	Use Vn of application board interface	Use TIOCB0 of application board interface	R90
R85	Application board interface	Use IO5 of application board interface	Use Wp of application board interface	R86
R86	Application board interface	Use Wp of application board interface	Use IO5 of application board interface	R85
R88	Application board interface	Use IO4 of application board interface	Use Wn of application board interface	R74
R74	Application board interface	Use Wn of application board interface	Use IO4 of application board interface	R88

Option Link Settings				
Reference	Function	Fitted	Alternative (Removed)	Related To
R67	Application board interface	Use IO3 of application board interface	Use UD of application board interface	R78
R78	Application board interface	Use UD of application board interface	Use IO3 of application board interface	R67
R82	Application board interface	Use IO2 of application user interface	Use TxD0 for onboard RS232 module	R70
R70	Application board interface	Use TxD0 of for onboard RS232 module	Use IO2 of application user interface	R82
R76	Application board interface	Use IO1 of application board interface	Use RxD0 for onboard RS232 module	R59
R59	Application board interface	Use RxD0 for onboard RS232 module	Use IO1 of application board interface	R76
R79	Application board interface	Use IO0 of application board interface	Use CLK0 for onboard RS232 module	R66
R66	Application board interface	Use CLK0 for onboard RS232 module	Use IO0 of application board interface	R79
R54	Application board interface	Use WDTOVF of application board interface	Use TDO of E10A debugger interface	R123
R123	Application board interface	Use TDO of E10A debugger interface	Use WDTOVF of application board interface	R54

Table 6-6: Application board interface links.

Table 6-7 below describes the function of the option links associated with E8 and E10A debuggers. The default configuration is indicated by **BOLD** text.

Option Link Settings				
Reference	Function	Fitted	Alternative (Removed)	Related To
R4	E8	Enables E8		
R132	E10A	Enables E10A, also can be enabled by fitting J15.	E10A is disabled, can be enabled if J15 is set.	E10A_EN (J15) jumper

Table 6-7: E8 and E10A debugger links.

Table 6-8 below describes the function of the option links associated with power source. The default configuration is indicated by **BOLD** text.

Option Link Settings				
Reference	Function	Fitted	Alternative (Removed)	Related To
R3	Power source	Enables external 5V power supply from 'PWR' (J7) connector.	Disables power supply from 'PWR' (J7) connector.	R13, R47, R48
R13	USB Power source	Enables USB VBUS as power supply for this RSK board.	Disables USB VBUS as power supply.	R3, R50
R18	3V3 power source	Board can be powered from external source CON_3V3.	Board can't be powered from external source CON_3V3.	R24, R40, R52
R22	Power source	Enables power supply for E8.	Disables E8 power supply	R3, R13
R24	Power source	Enables 3V3 power supply for on-board devices.	Disables 3V3 power supply for on-board devices. Current can be measured across R24	R18, R40
R40	3V3 power source	The RSK board uses on-board voltage regulator.	The board can be powered from CON_3V3 header.	R18, R24
R47	Power source	LCD is powered directly from PWR connector or from CON_5V header	LCD is not powered directly from PWR connector or from CON_5V header	R49, R51
R48	5V External power supply	Board can be powered from external source CON_5V	Board cannot be powered from external source CON_5V.	R50, R52
R49	USB Power source	Enables on-board debug LCD power supply from USB VBUS.	Disables on-board debug LCD power supply from USB VBUS.	R13, R47, R50, R51
R50	USB Power source	Enables USB VBUS as 5V power supply for an external application boards.	Disconnects USB VBUS from external application board header.	R13
R51	Power source	Enables on-board LCD to be powered from external 5V PSU	Disables on-board LCD to be powered from external PSU	R47, R49
R52	Power source	Enables power supply for a general application board from external 5V PSU	Disables power supply of a general application board from external 5V PSU	R48, R50
R42	Ground	Enables ground connection to ADC module.	Disconnects ground connection to ADC module.	-

Table 6-8: Power configuration links.

Table 6-9 below describes the function of the option links associated with clock configuration. The default configuration is indicated by BOLD text.

Option Link Settings				
Reference	Function	Fitted	Alternative (Removed)	Related To
R93	32.768 KHz Clock Oscillator	Routes OSC1 CPU pin to J3 header	OSC1 CPU pin and J3 header are not connected	R94, R103, R105
R94	32.768 KHz Clock Oscillator	Routes OSC2 CPU pin to J3 header	OSC2 CPU pin and J3 header are not connected	R93, R103, R105
R103	32.768 KHz Clock Oscillator	On-board low-speed clock source is used	External clock source is used	R93, R94, R104
R105	32.768 KHz Clock Oscillator	On-board low-speed clock source is used	External clock source is used	R94, R93, R103
R98	32.768 KHz Clock Oscillator	Parallel resistor for a crystal	Not fitted	-
R99	12 MHz Clock Oscillator	Routes EXTAL CPU pin to J3 header.	EXTAL CPU pin and J3 header are not connected	R102, R101, R100
R102	12 MHz Clock Oscillator	Routes XTAL CPU pin to J3 and JA2 headers	XTAL CPU pin and J3 and JA2 headers are not connected	R99, R101, R100
R101	12 MHz Clock Oscillator	On-board main clock source is used	External clock source is used	R99, R102
R100	12 MHz Clock Oscillator	Parallel resistor for a crystal	Not fitted	-

Table 6-9: Clock configuration links.

Table 6-10 below describes the function of the option links associated with reference voltage source. The default configuration is indicated by **BOLD** text.

Option Link Settings				
Reference	Function	Fitted	Alternative (Removed)	Related To
R64	Voltage Reference Source	Voltage Reference set to Board_Vcc signal.	Voltage Reference taken from external connector.	R83
R83	Voltage Reference Source	Voltage Reference is taken from external connector.	Voltage Reference set to Board_Vcc signal.	R64

Table 6-10: Voltage reference links.

Table 6-11 below describes the function of the option links associated with analog power supply. The default configuration is indicated by **BOLD** text.

Option Link Settings				
Reference	Function	Fitted	Alternative (Removed)	Related To
R21	Analog Voltage Source	Analog Voltage Source is set to on-board Vcc.	Analog Voltage Source is taken from external connector.	R46
R46	Analog Voltage Source	Analog Voltage Source is taken from external connector.	Analog voltage source is set to on-board Vcc.	R21
R137	Analog Voltage Ground	Analog Voltage Ground is routed to external connector.	Analog Voltage Ground is disconnected from external connector.	-

Table 6-11: Analog power supply links.

Table 6-12 below describes the function of the option links associated with MCU modes. The default configuration is indicated by **BOLD** text.

Option Link Settings				
Reference	Function	Fitted	Alternative (Removed)	Related To
R44	MCU Mode, USB unit	The CPU is self powered.	The CPU is power from USB bus.	J10
R131	MCU Mode	Enables SDRAM interface.	Disables SDRAM interface.	J14
R130	MCU Mode, USB unit	USB dedicated clock is $EXTAL \times 3$ (choose this option if 16 MHz crystal is used).	USB dedicated clock is $EXTAL \times 4$ (choose this option if 12 MHz crystal is used).	J13
R133	MCU Boot mode	Serial Boot Mode is selected.	USB Boot Mode is selected.	J16

Table 6-12: MCU mode links.

6.7. Oscillator Sources

Two crystal oscillators are fitted on the RSK and used to supply the main clock input to the Renesas microcontroller. Table 6-13 details the oscillators that are fitted and alternative footprints provided on this RSK:

Component		
Crystal (X1)	Fitted	12.0 MHz (HC49/4H package)
Crystal (X2)	Fitted	32.768 KHz

Table 6-13: Oscillators / Resonators

6.8. Reset Circuit

The CPU Board includes a simple latch circuit that links the mode selection and reset circuit. This provides an easy method for swapping the device between Boot Mode and User mode. This circuit is not required on customer's boards as it is intended for providing easy evaluation of the operating modes of the device on the RSK. Please refer to the hardware manual for more information on the requirements of the reset circuit.

The Reset circuit operates by latching the state of the boot switch on pressing the reset button. This control is subsequently used to modify the mode pin states as required.

The mode pins should change state only while the reset signal is active to avoid possible device damage.

The reset is held in the active state for a fixed period by a pair of resistors and a capacitor. Please check the reset requirements carefully to ensure the reset circuit on the user's board meets all the reset timing requirements.

6.9. USB port

This RSK has a Full-speed (12 Mbps) USB port compliant to USB 2.0 specification. It is available as J12 on the RSK. This port allows Boot mode programming using **USB Direct** connection. For more details please refer to *H8SX/1668R Group Hardware Manual*.

Chapter 7. Modes

This RSK supports two Boot modes and Single Chip mode.

Details of programming the FLASH memory is described in the H8SX/1668R Group Hardware Manual.

7.1. Boot mode

The boot mode settings for this RSK are shown in Table 7-1: Boot Mode pin settings below:

EMLE	MD2	MD1	MD0	PM2	LSI State after Reset End
0	0	1	0	0	SCI boot mode
0	0	1	0	1	USB boot mode

Table 7-1: Boot Mode pin settings

The software supplied with this RSK supports debugging with E10A which does not need Boot mode. To enter the Boot mode manually, do not connect the E10A in this case. Press and hold the SW1/BOOT. The BOOT LED will be illuminated to indicate that the microcontroller is in boot mode.

SCI boot mode: boot mode executes programming/erasure of the user MAT or user boot MAT by means of the control command and program data transmitted from the externally connected host via the on-chip SCI_4.

USB boot mode: executes programming/erasing of the user MAT by means of the control command and program data transmitted from the externally connected host via the USB.

7.2. Single chip mode

This is default operating mode of this RSK. Refer to H8SX/1668R Group Hardware Manual for details of Single chip mode. The Single chip mode settings for this RSK are shown in Table 7-2: Single chip mode pin settings below:

EMLE	MD2	MD1	MD0	LSI State after Reset End
0	1	1	1	Single chip Mode

Table 7-2: Single chip Mode pin settings

Programming/erasure of the user MAT is executed by downloading an on-chip program. The user boot MAT cannot be programmed/erased in user program mode.

Chapter 8. Programming Methods

The board is intended for use with HEW and the supplied E10A debugger. Refer to H8SX/1668R Group Hardware Manual for details of programming the microcontroller without using these tools. Please note that to use E10A debugger, jumper E10A_EN (J15) must be fitted.

Chapter 9. Headers

9.1. Microcontroller Headers

Table 9-1 to Table 9-4 show the microcontroller pin headers and their corresponding microcontroller connections. The header pins connect directly to the microcontroller pin unless otherwise stated.

J1					
Pin	Circuit Net Name	Device Pin	Pin	Circuit Net Name	Device Pin
1	CS1n	1	2	CS2n	2
3	LED0	3	4	GROUND	4
5	DLCDD7	5	6	UC_VCC	6
7	MD2	7	8	TxD6	8
9	RxD6	9	10	PM2	10
11	A23	11	12	A22	12
13	A21	13	14	A20	14
15	A19	15	16	GROUND	16
17	A18	17	18	A17	18
19	A16	19	20	A15	20
21	A14	21	22	A13	22
23	GROUND	23	24	A12	24
25	UC_VCC	-	26	A11	26
27	A10	27	28	A9	28
29	A8	29	30	A7	30
31	A6	31	32	GROUND	32
33	A5	33	34	A4	34
35	A3	35	36	A2	36

Table 9-1: J1

J2					
Pin	Circuit Net Name	Device Pin	Pin	Circuit Net Name	Device Pin
1	A1	37	2	A0	38
3	EMLE	39	4	PM3	40
5	PM4	41	6	UC_VCC	-
7	NC	-	8	NC	-
9	GROUND	-	10	VBUS_DET	46
11	MD_CLK	47	12	GROUND	48
13	IO0_CLK0	49	14	UC_VCC	50
15	IO1_RxD0	51	16	IO2_TxD0	52
17	IO3_UD	53	18	IO4_Wn	54
19	IO5_Wp	55	20	TIOCA0_Vp	56
21	TIOCB0_Vn	57	22	TRISTn	109
23	IO6	59	24	IO7	60
25	NMI _n	61	26	DREQ1 _n	62
27	TEND1 _n	63	28	UC_VCC	64
29	D0	65	30	D1	66
31	D2	67	32	D3	68
33	GROUND	69	34	D4	70
35	D5	71	36	D6	72

Table 9-2: J2

J3					
Pin	Circuit Net Name	Device Pin	Pin	Circuit Net Name	Device Pin
1	D7	73	2	UC_VCC	74
3	D8	75	4	D9	76
5	D10	77	6	D11	78
7	GROUND	79	8	D12	80
9	D13	81	10	D14	82
11	D15	83	12	IRQ0n	84
13	IRQ1n	85	14	LED3	86
15	IRQ3n_ADTRGn	87	16	GROUND	88
17	CON_OSC2 (*)	89	18	CON_OSC1 (*)	90
19	RESn	91	20	NC	-
21	TxD5	93	22	RxD5	94
23	WDTOVF _n _TDO	95	24	GROUND	96
25	CON_XTAL (*)	97	26	CON_EXTAL (*)	98
27	UC_VCC	99	28	P1_6	100
29	P1_7	101	30	STBYn	102
31	GROUND	-	32	DACK1n	104
33	TIOCA2_Up	105	34	TIOCB2_Un	106
35	PTTX	107	36	PTRX	108

Table 9-3: J3

J4					
Pin	Circuit Net Name	Device Pin	Pin	Circuit Net Name	Device Pin
1	TRSTn	109	2	UC_VCC	-
3	TMS	111	4	GROUND	-
5	TDI	113	6	TCK	114
7	MD0	115	8	LED1	116
9	LED2	117	10	ADPOT_AN0	118
11	AN1	119	12	AN2	120
13	CON_AVCC	121	14	AN3	122
15	AVSS	123	16	AN4	124
17	CON_VREF	125	18	AN5	126
19	DA0_AN6	127	20	DA1_AN7	128
21	MD1	129	22	DLCDD4	130
23	DLCDD5	131	24	DLCDD6	132
25	MD3	133	26	DLCDRS	134
27	WRn	135	28	DLCDE	136
29	LLWRn	137	30	LHWRn	138
31	RDn	139	32	ASn	140
33	GROUND	141	34	BCLK	142
35	UC_VCC	143	36	CS0n	144

Table 9-4: J4

9.2. Application Headers

Table 9-5 to Table 9-9 below show the standard application header connections.

JA1							
Pin	Generic Header Name	CPU board Signal Name	Device Pin	Pin	Generic Header Name	CPU board Signal Name	Device Pin
1	5V	CON_5V	-	2	0V	GROUND	-
3	3V3	CON_3V3	-	4	0V	GROUND	-
5	AVCC	CON_AVCC	121	6	AVss	CON_AVSS	123
7	AVref	CON_VREF	125	8	ADTRG	ADTRGn	87
9	AD0	AN0 (**)	118	10	AD1	AN1	119
11	AD2	AN2	120	12	AD3	AN3	122
13	DAC0	DA0 (**)	127	14	DAC1	DA1	128
15	IO_0	IO0 (**)	49	16	IO_1	IO1 (**)	51
17	IO_2	IO2 (**)	52	18	IO_3	IO3 (**)	53
19	IO_4	IO4 (**)	54	20	IO_5	IO5 (**)	55
21	IO_6	IO6	59	22	IO_7	IO7	60
23	IRQ3	IRQ3n (**)	87	24	IIC_EX	NC	-
25	IIC_SDA	SDA0	-	26	IIC_SCL	SCL0	-

Table 9-5: JA1 Standard Generic Header

JA2							
Pin	Generic Header Name	CPU board Signal Name	Device Pin	Pin	Generic Header Name	CPU board Signal Name	Device Pin
1	RESn	RESn	91	2	EXTAL	CON_EXTAL	97
3	NMIIn	NMIIn	61	4	VSS1	GROUND	-
5	WDT_OVF	WDTOVF	95	6	SClATX	TxD0 (**)	52
7	IRQ0	IRQ0n	84	8	SClARX	RxD0 (**)	51
9	IRQ1	IRQ1n	85	10	SClACK	CLK0 (**)	49
11	UD	UD (**)	53	12	CTSRTS	NC	-
13	Up	Up (**)	105	14	Un	Un (**)	106
15	Vp	Vp (**)	56	16	Vn	Vn (**)	57
17	Wp	Wp (**)	55	18	Wn	Wn (**)	54
19	TMR0	TIOCA0 (**)	56	20	TMR1	TIOCA2 (**)	105
21	TRIGa	TIOCB0	57	22	TRIGb	TIOCB2 (**)	106
23	IRQ2	IRQ3n (**)	87	24	TRISTn	TRISTn	109
25	-	-	-	26	-	-	-

Table 9-6: JA2 Standard Generic Header

JA5							
Pin	Generic Header Name	CPU board Signal Name	Device Pin	Pin	Generic Header Name	CPU board Signal Name	Device Pin
1	AD4	AN4	124	2	AD5	AN5	126
3	AD6	AN6 (**)	127	4	AD7	AN7 (**)	128
5	CAN1TX	-	-	6	CAN1RX	-	-
7	CAN2TX	-	-	8	CAN2RX	-	-
9	-	-	-	10	-	-	-
11	-	-	-	12	-	-	-
13	-	-	-	14	-	-	-
15	-	-	-	16	-	-	-
17	-	-	-	18	-	-	-
19	-	-	-	20	-	-	-
21	-	-	-	22	-	-	-
23	-	-	-	24	-	-	-

Table 9-7: JA5 Standard Generic Header

JA6							
Pin	Generic Header Name	CPU board Signal Name	Device Pin	Pin	Generic Header Name	CPU board Signal Name	Device Pin
1	DREQ	DREQ1n	62	2	DACK	DACK1n	104
3	TEND	TEND1n	63	4	STBYn	NC	-
5	RS232TX	RS232TX	-	6	RS232RX	RS232RX	-
7	SCIbRX	RxD5	94	8	SCIbTX	TxD5	8
9	SClCtTX	TxD6	93	10	SCIbCK		-
11	SClCCK	NC	-	12	SClCRX	RxD6	9
13	-	-	-	14	-	-	-
15	-	-	-	16	-	-	-
17	-	-	-	18	-	-	-
19	-	-	-	20	-	-	-
21	-	-	-	22	-	-	-
23	-	-	-	24	-	-	-

Table 9-8: JA6 Standard Generic Header

JA3							
Pin	Generic Header Name	CPU board Signal Name	Device Pin	Pin	Generic Header Name	CPU board Signal Name	Device Pin
1	A0	A0	38	2	A1	A1	37
3	A2	A2	36	4	A3	A3	35
5	A4	A4	34	6	A5	A5	33
7	A6	A6	31	8	A7	A7	30
9	A8	A8	29	10	A9	A9	28
11	A10	A10	27	12	A11	A11	26
13	A12	A12	24	14	A13	A13	22
15	A14	A14	21	16	A15	A15	20
17	D0	D0	65	18	D1	D1	66
19	D2	D2	67	20	D3	D3	68
21	D4	D4	70	22	D5	D5	71
23	D6	D6	72	24	D7	D7	73
25	RDn	RDn	139	26	WRn	WRn	135
27	CS0n	CS0n	144	28	CS1n	CS1n	1
29	D8	D8	75	30	D9	D9	76
31	D10	D10	77	32	D11	D11	78
33	D12	D12	80	34	D13	D13	81
35	D14	D14	82	36	D15	D15	83
37	A16	A16	19	38	A17	A17	18
39	A18	A18	17	40	A19	A19	15
41	A20	A20	14	42	A21	A21	13
43	A22	A22	12	44	SDCLK	BCLK	142
45	CS2n	CS2n	2	46	ALE	ASn	140
47	WRHn	LHWRn	138	48	WRLn	LLWRn	137
49	CASn	-	-	50	RASn	-	-

Table 9-9: JA3 Standard Generic Header

* - Optional link. By default, these signals are disconnected.

** - Optional link. Please refer to schematic for details.

Chapter 10. Code Development

10.1. Overview

Note: For all code debugging using Renesas software tools, the RSK board must be connected to a PC USB port via an E10A. An E10A pod is supplied with the RSK product.

10.2. Compiler Restrictions

The compiler supplied with this RSK is fully functional for a period of 60 days from first use. After the first 60 days of use have expired, the compiler will default to a maximum of 64k code and data. To use the compiler with programs greater than this size you need to purchase the full tools from your distributor.

Warning: The protection software for the compiler will detect changes to the system clock. Changes to the system clock back in time may cause the trial period to expire prematurely.

10.3. Mode Support

HEW connects to the Microcontroller and programs it via the E10A. Mode support is handled transparently to the user.

10.4. Breakpoint Support

HEW supports breakpoints on the user code, both in RAM and ROM.

Double clicking in the breakpoint column in the code sets the breakpoint. Breakpoints will remain unless they are double clicked to remove them.

10.5. Memory Map

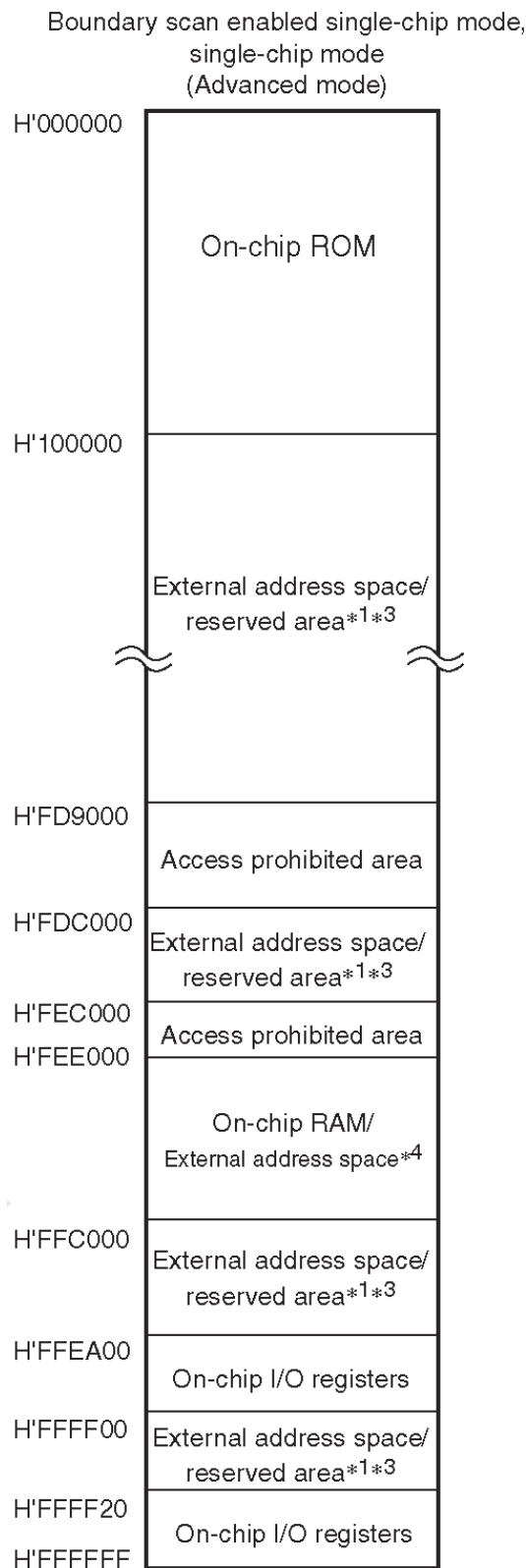

- Notes:1. This area is specified as the external address space when EXPE = 1 and the reserved area when EXPE = 0.
 2. The on-chip RAM is used for flash memory programming. Do not clear the RAME bit in SYSCR to 0.
 3. Do not access the reserved areas.
 4. This area is specified as the external address space by clearing the RAME bit in SYSCR to 0.

Figure 10-1: Memory Map

Chapter 11. Component Placement

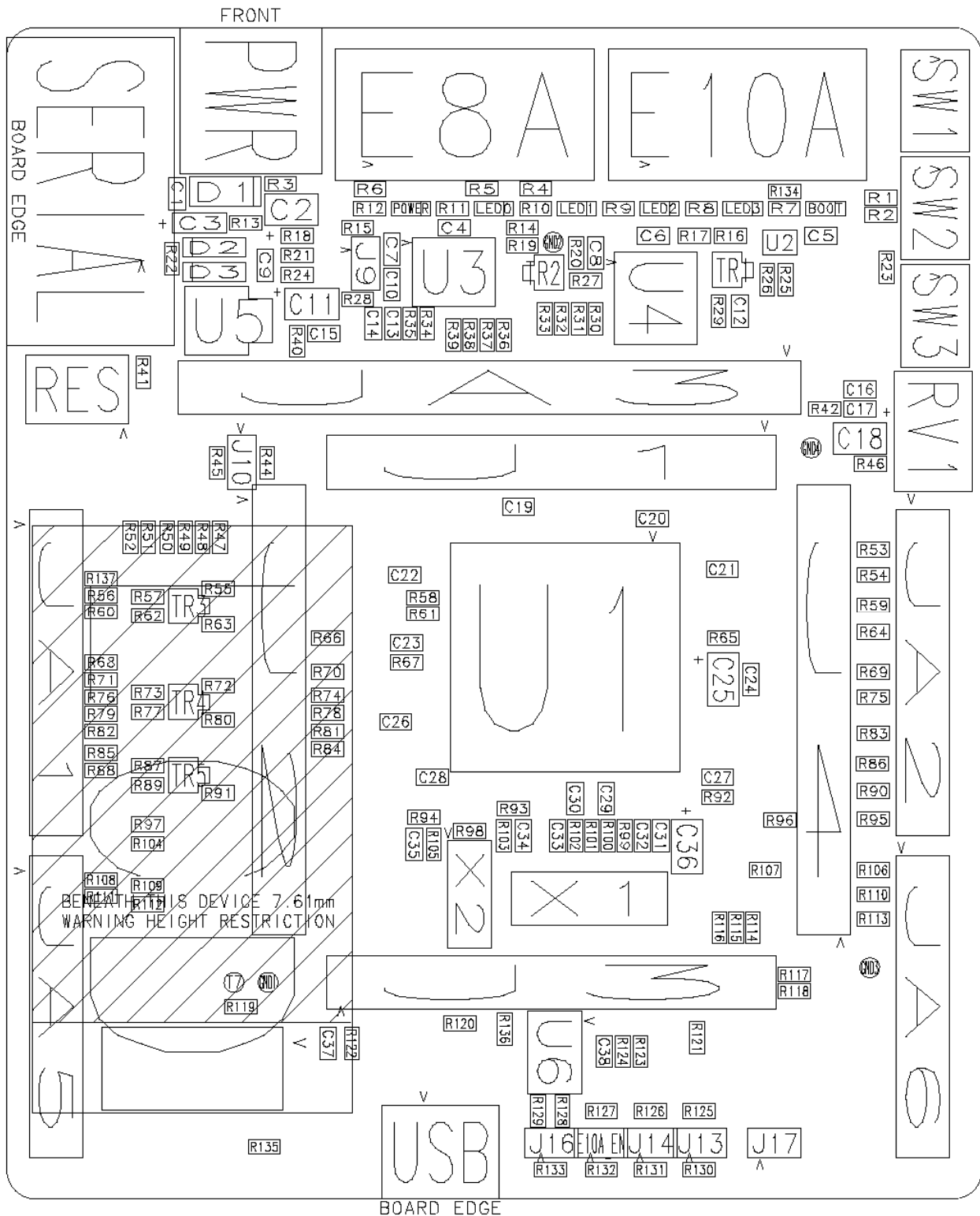

Figure 11-1: Component Placement – Front view

Chapter 12. Additional Information

For details on how to use High-performance Embedded Workshop (HEW, refer to the HEW manual available on the CD or from the web site.

For information about the H8SX/1668R series microcontrollers refer to the H8SX/1668R Group hardware manual.

For information about the H8SX/1668R assembly language, refer to the H8SX Series Software Manual.

Online technical support and information is available at: http://www.renesas.com/renesas_starter_kits

Technical Contact Details

America: techsupport.rta@renesas.com

Europe: tools.support.eu@renesas.com

Japan: csc@renesas.com

General information on Renesas Microcontrollers can be found on the Renesas website at: <http://www.renesas.com/>

Renesas Starter Kit for H8SX/1668R

User's Manual

Publication Date Rev.1.00 04.04.2008

Published by: **Renesas Technology Europe Ltd.**

Duke's Meadow, Millboard Road, Bourne End

Buckinghamshire SL8 5FH, United Kingdom

©2008 Renesas Technology Europe and Renesas Solutions Corp., All Rights Reserved.

Renesas Starter Kit for H8SX/1668R
User's Manual

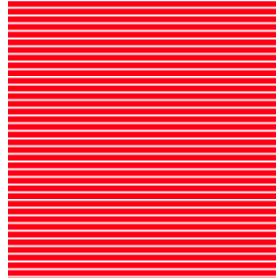

Renesas Technology Europe Ltd.
Duke's Meadow, Millboard Road, Bourne End
Buckinghamshire SL8 5FH, United Kingdom

Free Manuals Download Website

<http://myh66.com>

<http://usermanuals.us>

<http://www.somanuals.com>

<http://www.4manuals.cc>

<http://www.manual-lib.com>

<http://www.404manual.com>

<http://www.luxmanual.com>

<http://aubethermostatmanual.com>

Golf course search by state

<http://golfingnear.com>

Email search by domain

<http://emailbydomain.com>

Auto manuals search

<http://auto.somanuals.com>

TV manuals search

<http://tv.somanuals.com>