

***RESMED***

**VPAP™ Adapt SV**  
**User Guide**

English

# Contents

<b>Introduction</b> .....	3
VPAP™ Adapt SV	3
User/owner responsibility	3
Definitions	3
Medical Information	3
<b>Quick Setup Guide</b> .....	5
<b>VPAP Adapt SV System</b> .....	6
VPAP Adapt SV Components	6
Assembling the VPAP Adapt SV System	8
Humidifiers	10
ResLink™	14
Anti-bacterial Filter	14
Using DC Power to Run the VPAP Adapt SV	15
Supplemental Oxygen	15
<b>Using the VPAP Adapt SV</b> .....	16
Starting Treatment	16
Stopping Treatment	16
Standby Mode	16
Control Panel Functions	17
Adjusting Settings	18
Menus	20
Treatment Screens	24
<b>Alarms</b> .....	25
Low Mask Pressure Alarm	25
Power Fail Alarm	26
High Pressure / High Average Pressure Alarms	26
High Leak Alert	27
Insufficient Pressure Support Alarm	27
Flow Blocked Alarm	27
<b>Cleaning and Maintenance</b> .....	28
Daily	28
Weekly	28
Periodically	29
Air Filter	30
Servicing	30
<b>Troubleshooting</b> .....	31
<b>Glossary</b> .....	32
<b>Technical Specifications</b> .....	33
<b>Limited Warranty</b> .....	40
<b>Index</b> .....	41

# Introduction

## VPAP™ Adapt SV

The VPAP Adapt SV flow generator has been designed to be reliable, comfortable and easy to use. You can observe your treatment and make adjustments to settings using a keypad and LCD screen.



### **CAUTION**

USA federal law restricts this device to sale by or on the order of a physician.

## User/Owner Responsibility

The user or owner of this system shall have sole responsibility and liability for any injury to persons or damage to property resulting from:

- operation which is not in accordance with the operating instructions supplied
- maintenance or modifications carried out unless in accordance with authorized instructions and by authorized persons.

**Please read this manual carefully before use.**

## Definitions



### **WARNING**

Alerts you to possible injury.



### **CAUTION**

Explains special measures for the safe and effective use of the device.

## Medical Information

### **Intended Use**

The VPAP Adapt SV system is intended to provide non-invasive ventilatory support to treat adult patients with obstructive sleep apnea (OSA) and respiratory insufficiency caused by central and/or mixed apneas and periodic breathing. This device is intended for use in the hospital or home.

### **Contraindications**

The VPAP Adapt SV is not a life support ventilator and may stop operating with power failure or in the unlikely event of certain fault conditions.

Before using the VPAP Adapt SV tell your doctor if you have any of the following conditions:

- hypotension or significant intravascular volume depletion
- acute sinusitis or otitis media
- epistaxis (severe nosebleeds) causing a risk of pulmonary aspiration
- conditions predisposing to a risk of vomiting into mask

- impaired ability to clear secretions
- pneumothorax or pneumomediastinum
- recent cranial trauma or surgery
- chronic hypoventilation.

**Below are general warnings and cautions. Further specific warnings, cautions and notes appear next to the relevant instructions in the manual.**



## **WARNINGS**

- The VPAP Adapt SV is NOT a life support ventilator.
- The entire manual should be read before using the VPAP Adapt SV.
- Advice contained in this manual should not supersede instructions given by the prescribing physician.
- The VPAP Adapt SV should be used with masks and accessories recommended by ResMed or the prescribing physician. Use of incorrect masks and accessories may adversely affect the function of the VPAP Adapt SV.
- The VPAP Adapt SV is designed for use with masks that allow exhaled gases to be flushed out through vent holes. Exhaled gases will be rebreathed if the mask is worn with the machine turned off, or the vent holes are occluded. If this occurs over prolonged periods, suffocation may occur.
- In the event of power failure or machine malfunction, remove the mask.
- The air flow for breathing produced by this device can be as much as 11°F (6°C) higher than the temperature of the room. Caution should be exercised if the room temperature is warmer than 90°F (32°C).
- The VPAP Adapt SV can be set to deliver pressures up to 25 cm H<sub>2</sub>O. In the unlikely event of certain fault conditions, pressures of up to 40 cm H<sub>2</sub>O for less than one second are possible.
- The VPAP Adapt SV is not suitable for use in the vicinity of flammable anesthetics.
- If oxygen is used with the VPAP Adapt SV, the oxygen flow should be stopped when the device is not operating. If oxygen flow continues when the device is not operating, oxygen may accumulate within the device and create a risk of fire.
- Do not use the VPAP Adapt SV if there are obvious external defects or unexplained changes in performance.
- Do not open the VPAP Adapt SV case. There are no user serviceable parts inside. Repairs and internal servicing should only be performed by an authorized service agent.



## **CAUTIONS**

You should report unusual chest pain, severe headache or increased breathlessness to your physician. An acute upper respiratory tract infection may require temporary discontinuation of treatment.

The following side effects may arise during a course of therapy with the VPAP Adapt SV:

- drying of the nose, mouth, or throat
- bloating
- ear or sinus discomfort
- eye irritation
- skin rashes
- chest discomfort.

## Quick Setup Guide

- 1** Attach the air tubing and pressure sensor tube to the VPAP Adapt SV and mask (page 9).

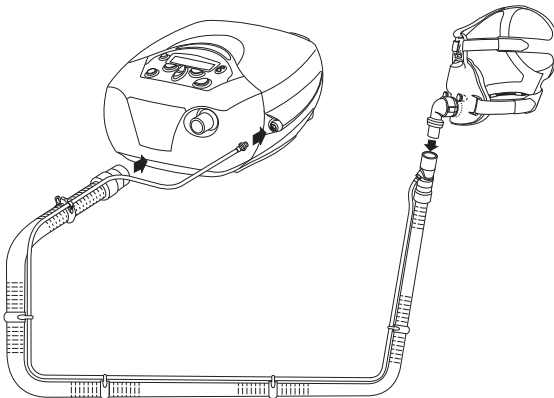

- 2** Attach a humidifier if required (page 10).
- 3** Switch on the VPAP Adapt SV. Make sure the mask is unblocked.
- 4** Select the mask setting (page 21).
- 5** Perform the Air Circuit Learn function (page 21) at first-time use, or if you are adding or removing a component of the system (eg, a humidifier or anti-bacterial filter).
- 6** Fit the mask and commence breathing into it. The SmartStart™ function should trigger treatment to commence within the first couple of breaths. If not, press the **Start/Stop** key once to commence treatment (page 16).

**Note:** You can observe treatment progress (eg, mask leak) via the Treatment screens (page 24).

- 7 Remove your mask to stop treatment. If SmartStop is enabled, treatment will stop automatically. If the SmartStop function has been disabled, press the **Start/Stop** key once.

## VPAP Adapt SV System

### VPAP Adapt SV Components

The VPAP Adapt SV flow generator is supplied with air tubing and a power cord. Masks are supplied separately, as you and your clinician have to decide which mask is best for you.

Some people experience dryness of the nose, mouth and throat while using the VPAP Adapt SV system, especially during winter. Others may experience sneezing and/or a runny or blocked nose during the first few weeks of VPAP treatment. In many cases, these symptoms of nasal irritation can be resolved with a humidifier. See page 10 to connect a humidifier to the VPAP Adapt SV.

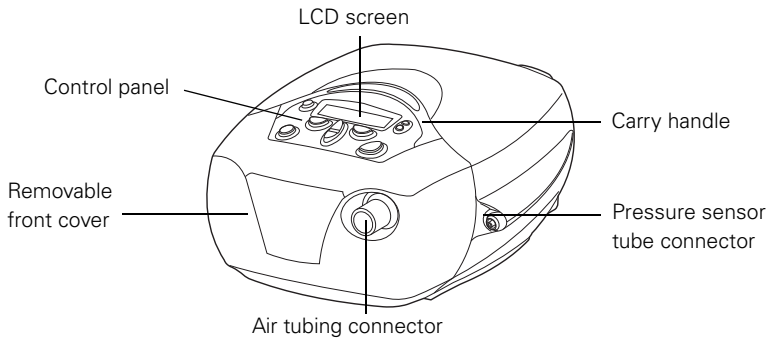

**Figure 1: VPAP Adapt SV flow generator**

The control panel allows you to adjust settings on the flow generator, and the LCD screen displays information about your treatment. See "Control Panel Functions" on page 17.

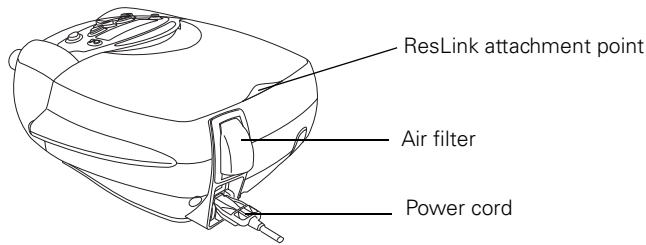

**Figure 2: Rear of VPAP Adapt SV**

See page 14 to connect a ResLink™. See page 30 to replace the air filter.

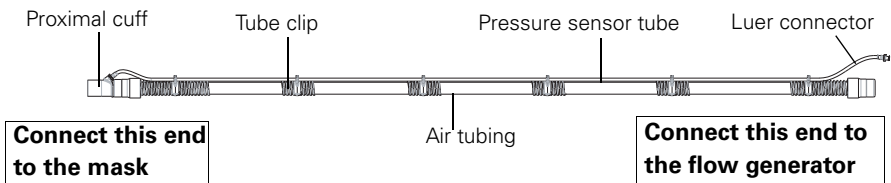

**Figure 3: Air tubing fully assembled**

All necessary air tubing components are packed with the VPAP Adapt SV:

- a 6'6" (2 m) length of air tubing
- a pressure sensor tube (to measure pressure at the mask) with Luer connectors
- tube clips (to hold the pressure sensor tube onto the air tubing)
- a proximal cuff (a special connector that attaches the pressure sensor tube into the main air tubing so you only need to make one attachment to the mask).

The air tubing is supplied with the proximal cuff connected. Attach the tube clips evenly along the air tubing. Press the pressure sensor tube into the tube clips, and screw the Luer connectors together at the proximal cuff. Make sure the pressure sensor tube is not kinked, obstructed or twisted.

**Note:** ResMed recommends the following tubing products for use with the VPAP Adapt SV: replacement air hose (only) PN14986; replacement air delivery system (hose, sensor line, clips, proximal cuff) PN26923.

## Masks

You will also need a ResMed mask system (supplied separately). For the latest available masks, see [www.resmed.com](http://www.resmed.com). Please refer to the table on page 21 to set up your mask correctly for use with the VPAP Adapt SV. Your clinician can explain the features of the masks available and will discuss the mask that best suits your needs.

# Assembling the VPAP Adapt SV System

Complete the following steps to assemble the VPAP Adapt SV system. Make sure the area around the unit is clean (dust free) and clear of bedding, clothes and any other potential blockages.

To add a humidifier see page 10.



## WARNING

Use only the air tubing system supplied with the VPAP Adapt SV system.

### 1 Connect the power cord

There are two sockets at the rear of the flow generator—the top one for an AC (standard mains electricity) and the lower one for a DC power cord (see “Using DC Power to Run the VPAP Adapt SV” on page 15). ResMed recommends using the AC power cord supplied with the unit.

The customized ResMed power cord can be held in place with the locking clips. To insert the locking clip, pinch the free ends together and fit the pins into the holes on both sides of the socket. Insert the power cord into the socket. Push the locking clip down so that the groove holds the power cord in place. Plug one end of the power cord into the power socket at the rear of the unit, and the other end into a power outlet.

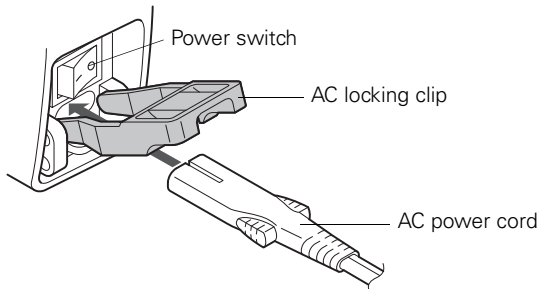

Plug the free end of the power cord into a power outlet.



## CAUTIONS

- Do not connect both AC and DC power cords to the VPAP Adapt SV at the same time.
- Be careful not to place the device where it can be bumped or where someone is likely to trip over the power cord.



## WARNING

Make sure the power cord and plug are in good condition and the equipment is not damaged.



## 2 Connect air tubing

Connect the air tube firmly onto the air outlet at the front of the unit.

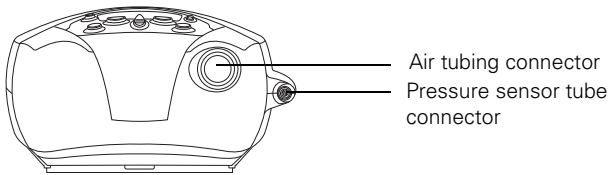

Figure 4: Front view of VPAP Adapt SV

**To attach the pressure sensor tube to the unit,** screw the Luer connector onto the socket on the side of the unit.

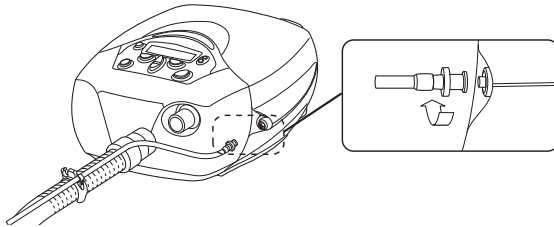

Figure 5: Twisting the Luer lock connectors together



### WARNING

Use care when handling the air tubing. Be particularly careful when attaching the Luer connector to the VPAP Adapt SV. If you kink or excessively twist the sensor tube it may affect the protection offered by the mask pressure alarm system.

## 3 Attach the mask to the air tubing.

The mask system should already be assembled. If it is not, please refer to the user instructions supplied with the mask.

Connect the mask system to the free end of the air tubing.

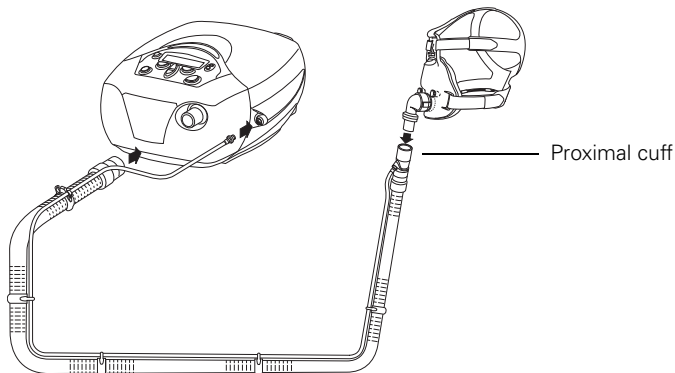

Figure 6: Assembling the VPAP Adapt SV system

# Humidifiers

A humidifier may be required if you are experiencing dryness of the nose, throat, or mouth. The following ResMed humidifiers are compatible with the VPAP Adapt SV:



HumidAire  
heated humidifier

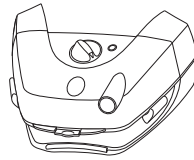

HumidAire 2i  
heated humidifier

Humidifier accessory (HumidAire only)



Medium air tubing  
21" (52 cm)

Figure 7: Humidifiers compatible with the VPAP Adapt SV

When using a humidifier, stop the VPAP Adapt SV by using the **Start/Stop** key or by removing the mask to trigger the SmartStop function. Do not switch the VPAP Adapt SV off at the power switch or the power source while it is running, as this could result in condensation in the motor.

Please refer to the relevant humidifier user manual for detailed instructions and warnings.



## CAUTIONS

- **Be very careful not to allow water to enter the VPAP Adapt SV** as this could affect therapy and/or damage the device.
- **Do not tip the humidifier while it is connected to the VPAP Adapt SV.** If water enters the VPAP Adapt SV device, turn off the main power switch at the back of the unit and unplug it from the power outlet. Return the unit to your equipment supplier for checking.

## Connecting a Humidifier

**Note:** After connecting or removing a humidifier, always perform the Air Circuit Learn function (see page 21).



## WARNING

When using a humidifier, position it so that it is lower than your head will be during sleep, and at the same level or lower than the VPAP Adapt SV.

## HumidAire 2i™

The HumidAire 2i provides heated humidification for the VPAP Adapt SV. To attach the HumidAire 2i, remove the VPAP Adapt SV front cover and attach the humidifier docking station and water chamber. No other accessories are required for use. Please refer to the *HumidAire 2i User's Manual* for details. Once you have performed the Air Circuit Learn function the VPAP Adapt SV is ready for use. See "Starting Treatment" on page 16.

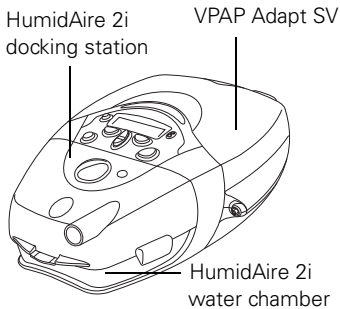

Figure 8: HumidAire 2i attached to the VPAP Adapt SV

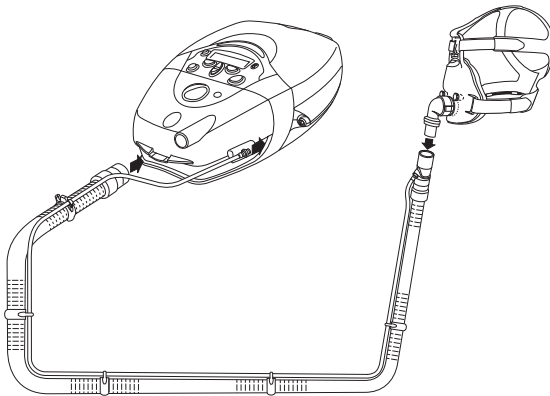

Figure 9: HumidAire 2i attached to VPAP Adapt SV and mask



### WARNING

- Make sure that the water chamber is empty and thoroughly dried before transporting the HumidAire 2i.
- When using the carry bag, always separate the VPAP Adapt SV unit and the HumidAire 2i before placing in their respective compartments.

## HumidAire™

You will need a medium size 21" (52 cm) air tube to connect the VPAP Adapt SV unit to the HumidAire™ (see Figure 7).

- 1** Make sure both the HumidAire and the VPAP Adapt SV are turned off. Fill the HumidAire with water as described in the humidifier manual. Place the filled water chamber inside the HumidAire.
- 2** Gently detach enough of the tube clips to release the end of the pressure sensor tube from the VPAP Adapt SV air tubing. Connect the VPAP Adapt SV air tubing to the left connector port on the humidifier, and the medium 21" (52 cm) air tubing to the right connector port. Close the HumidAire lid.

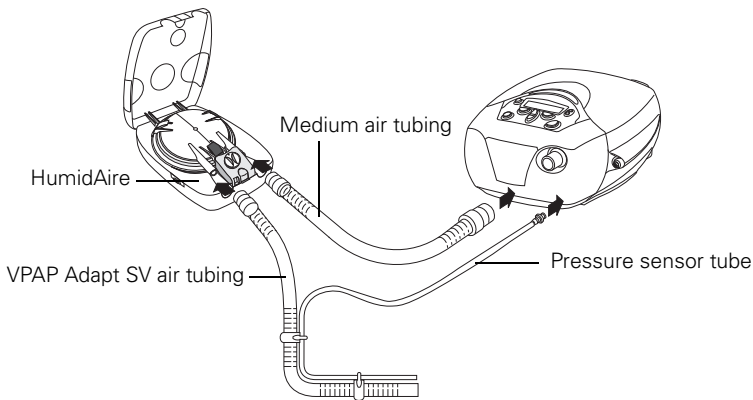

- 3** Place the VPAP Adapt SV on top of the HumidAire. Never place the VPAP Adapt SV unit underneath the humidifier. (This is to avoid water spilling into the unit.)

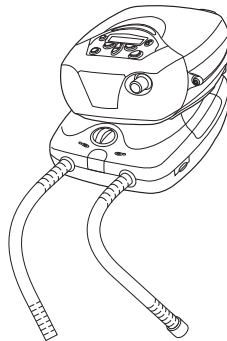

- 4** Connect the free end of the medium air tubing to the VPAP Adapt SV. Connect the pressure sensor tube by twisting the Luer lock onto the VPAP Adapt SV (see page 9).

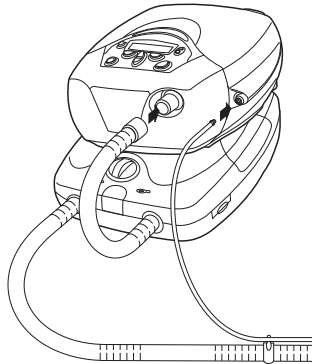

- 5** Connect the mask system to the free end of the long air tubing. The final assembly should look like this:

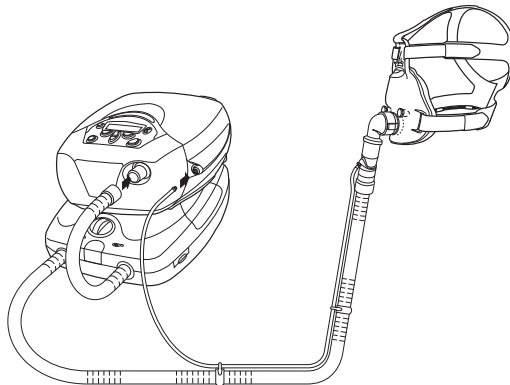

- 6** Switch on the HumidAire and the VPAP Adapt SV.



### **WARNING**

Make sure that the power cords and plugs are in good condition and the equipment is not damaged.

- 7** Perform the Air Circuit Learn function (see page 21).

For information about filling and maintaining your humidifier, refer to the *HumidAire User's Manual*.

The VPAP Adapt SV is now ready for use with the HumidAire. See "Starting Treatment" on page 16.



### **CAUTION**

- Set up the HumidAire and the VPAP Adapt SV unit so that the tubing to the mask runs higher than the machines. This will prevent condensation build-up.
- If condensation appears in the mask, turn the humidifier settings down.

## ResLink™

The ResLink is a device that records data onto a SmartMedia™ card during your therapy. The card can be returned to your clinician so that they can observe your progress and adjust flow generator parameters if necessary. The ResLink connects to the back of VPAP Adapt SV as shown. For full details on using the ResLink, please refer to the *ResLink User's Manual*.

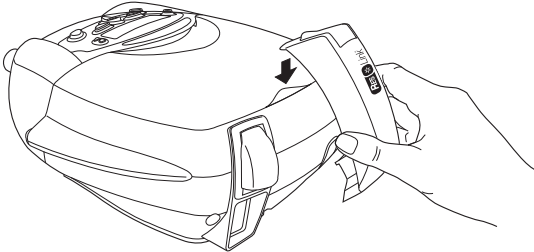

## Anti-bacterial Filter

Your clinician may recommend that you use an anti-bacterial filter. A filter should be placed in the air tubing between the mask and the flow generator. If using a humidifier, place the filter between it and the flow generator (see Figure 10 below).

Typically, the filter should be replaced daily. Check the filter instructions for full details.

Whenever a filter is added, removed or replaced you must run the Air Circuit Learn function (see "Learn Circuit" on page 21).

**Note:** Only hydrophobic anti-bacterial filters should be used with a HumidAire 2i.

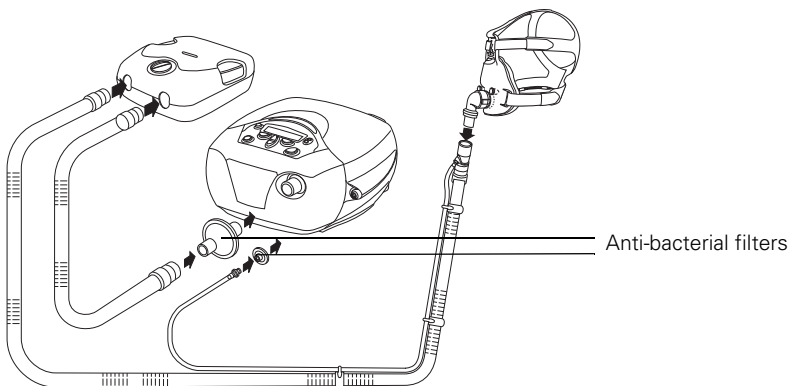

Figure 10: Inserting anti-bacterial filters

## Using DC Power to Run the VPAP Adapt SV

The VPAP Adapt SV can be run on DC in case of power failure. ResMed supplies separately a converter that allows a 12V or 24V battery to be connected to the DC input of the VPAP Adapt SV. When using a DC power supply, the power is turned on and off via the switch on the converter, and not the power switch at the back of the VPAP Adapt SV. The DC converter is a separate accessory that can be purchased through your ResMed distributor.

The humidifier heater will be automatically disabled when the VPAP Adapt SV is operating from the DC supply.

Power consumption of the VPAP Adapt SV varies with treatment settings. Adequate battery type and sizing is required before operation on DC, and it is recommended that you contact ResMed's Technical Services division or see ResMed's website for information on your specific application.



### CAUTION

The VPAP Adapt SV uses 30V DC power. Only connect the VPAP Adapt SV to DC power using the VPAP Adapt SV DC Converter (P/N 26928) specified for this application.

## Supplemental Oxygen

The VPAP Adapt SV is designed to be compatible with the use of low flow oxygen therapy provided from an external source and supplied at a fixed rate of up to 15 L/min. At a fixed flow rate of supplemental oxygen flow, the inhaled oxygen concentration will vary, depending on the pressure settings, patient breathing pattern, mask selection, and the leak rate. This warning applies to most types of bilevel machines.



### WARNING

- If oxygen is used with this device, the oxygen flow must be turned off when the device is not operating.  
Explanation: When the device is not in operation, and the oxygen flow is left on, oxygen delivered into the ventilator tubing may accumulate within the device enclosure and create a risk of fire.
- Always begin VPAP Adapt SV therapy before the oxygen supply is turned on.
- Always turn the oxygen supply off before stopping VPAP Adapt SV therapy.
- Oxygen supports combustion. Oxygen should not be used while smoking or in the presence of an open flame.

# Using the VPAP Adapt SV



## WARNING

Before starting therapy with a new mask, select the correct mask type in the Settings menu (page 21). When adding or removing a new component, such as a mask, humidifier, or anti-bacterial filter, perform the Air Circuit Learn function (page 21).

## Starting Treatment

When the system is fully assembled press the power switch at the back of the VPAP Adapt SV to ON. The Welcome screen will be displayed while the flow generator is warming up. Allow the unit to warm up for approximately 30 seconds before placing the mask on your face.



Figure 11: Welcome screen

Once the VPAP Adapt SV has warmed up, breathing into the mask should start therapy immediately. If not, press the **Start/Stop** key once to commence treatment.

The VPAP Adapt SV restarts in the mode in which it stopped.

## Stopping Treatment

If SmartStop is enabled, treatment will stop automatically when you remove your mask. If the SmartStop function has been disabled, press the **Start/Stop** key.

## Standby Mode

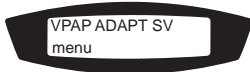

Figure 12: Standby screen

Once you have stopped treatment, the VPAP Adapt SV will be in standby mode. In standby you can:

- press the power switch at the back to OFF to turn off the flow generator
- commence treatment again by breathing into the mask or pressing the **Start/Stop** key
- enter any of the menus by pressing the **Left** key.

When in standby mode, a gentle (non-therapeutic) flow of air will still be present.

**Note:** If the SMART DATA - AUTO APPEAR option is set to ON the screens available under the Results menu will be displayed automatically for approximately 20 minutes after your session is completed.



## Control Panel Functions

The control panel of the VPAP Adapt SV has a keypad that allows you to:

- start or stop treatment
- adjust settings on the flow generator
- mute or stop alarms
- view treatment data.

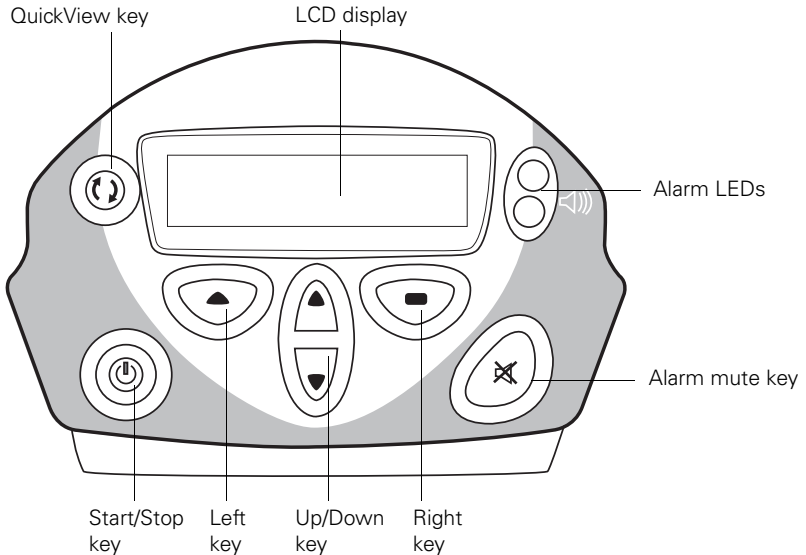

Figure 13: The VPAP Adapt SV control panel

### LCD screen

Displays information about flow generator settings, alarms and treatment. The LCD screen is backlit whenever any key is pressed. The lighting will turn off automatically when no button has been pressed for two minutes, or can be set to stay on (see “Options Menu” on page 23).

An alarm message will overwrite any other message on the screen. The original screen will reappear when any key is pressed.

### Start/Stop key

- Press the key once to start or stop treatment.

### Up/Down key

- Moves backwards and forwards within a menu and between menus.
- Increases and decreases values of parameters—press once to adjust in single increments; hold down to move quickly through the values.

### **Left key (green)**

- Enters a menu.
- Confirms and applies settings.
- Performs the function indicated by the text above it in the LCD (eg, 'enter', 'change').

### **Right key (red)**

- Performs the function indicated by the text above it in the LCD (eg, 'exit').
- Cancels operations.
- Extended hold: exits to the top level of the menu.

### **QuickView key**

Takes you immediately to the Treatment screens, with information on your current therapy. See "Treatment Screens" on page 24.

### **Alarm LEDs and Alarm mute**

The Alarm LEDs are lights that indicate that an alarm has been triggered. Alarms can be muted by pressing the **Alarm mute** key once. The Alarm LEDs will remain lit for as long as the alarm is being triggered. See "Alarms" on page 25.

## **Adjusting Settings**

By using the **Left**, **Right** and **Up/Down** keys you can adjust some aspects of your treatment. The settings can be seen in the LCD display.

To change a setting, press the **Up/Down** key until you arrive at the menu you require.

- Press the **Left** key to enter the menu, then use the **Up/Down** key again to scroll through the options.
- Once you find the option you require press the **Left** key to select the function that is displayed in the bottom left of the screen eg, 'change', 'yes'.
- Use the **Up/Down** key to alter the parameters and press the **Left** key when you have the setting you require.
- Press the **Right** key to exit from the menu.

## Example

You wish to change the setting for the mask you are using.

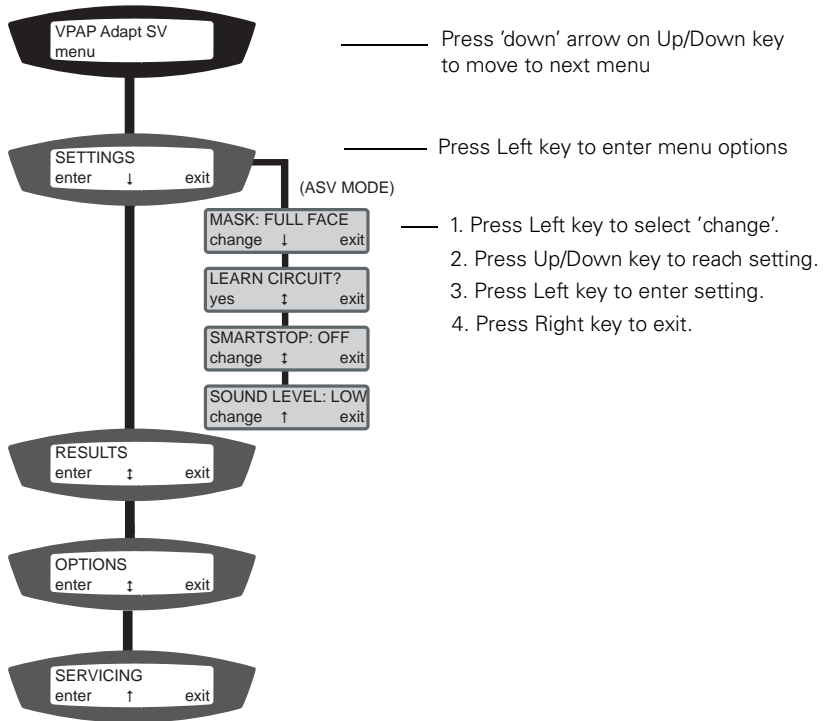

Figure 14: Using the keys to adjust settings

# Menus

The options available in the Settings menu will depend on the therapy you are receiving (either ASV or CPAP), as set by your clinician.

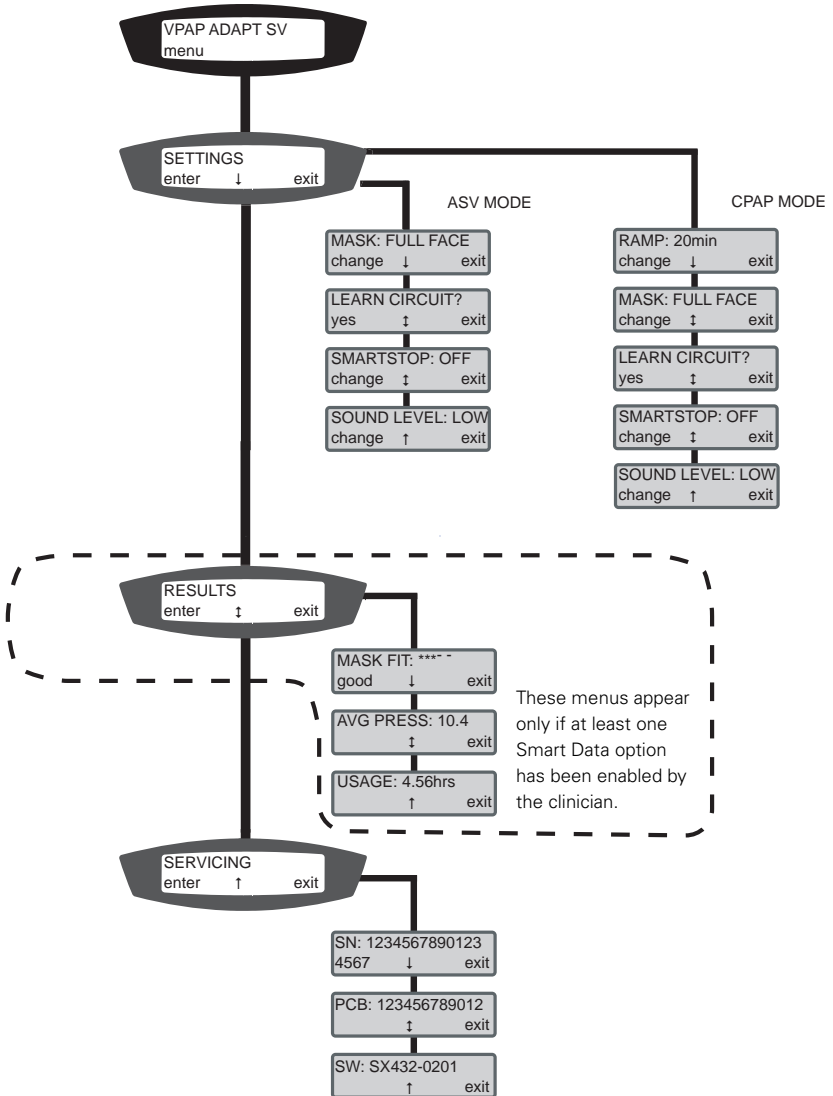

Figure 15: Navigating the Patient menu.

## Settings Menu

You will only see the options relevant to your therapy. In CPAP (Continuous Positive Airway Pressure) mode, the clinician sets a pressure that will be constant throughout treatment. In ASV mode, the VPAP Adapt SV continually measures your breathing and regulates the air pressure accordingly.

### Mask

Select the type of mask that you will be using (you will only need to adjust this if you have more than one mask). The following table shows the setting that should be selected for each mask type. If your mask type is not mentioned below, please contact your clinician. Not all mask types can be used with the VPAP Adapt SV.

Option in Settings menu	Use setting with:
Vista	Vista™
Ultra	Ultra Mirage™
Full Face	Mirage™ Full Face Mask Series II Ultra Mirage™ Full Face Mask Mirage Quattro™ Full Face Mask
Activa	Activa™

### Selecting mask options in the Settings menu

### Learn Circuit

The Air Circuit Learn function takes approximately 20 seconds to run. It allows the unit to 'learn' what pressure it needs to build in to its calculations, based on the components in the system. Select LEARN CIRCUIT every time you add or remove a component (eg, mask, humidifier) or move to a significantly different altitude.

To run this function:

1. Set up the entire VPAP Adapt SV system (flow generator, mask, humidifier etc) as you wish to use it.
2. Make sure that the mask is unobstructed so air can flow from the mask to the flow generator.
3. Turn on the VPAP Adapt SV at the power switch.
4. Move through the menus until you reach LEARN CIRCUIT and select 'yes' by pressing the **Left** key.
5. A message will remind you to check that the airflow from the mask is clear. Select 'start' with the **Left** key.
6. A progress screen is displayed while the Air Circuit Learn function is running.



7. When the function is complete, a screen will appear saying that the circuit has been learned successfully. The next menu item is then displayed.

Commence treatment as described in "Starting Treatment" on page 16. If there is a problem with the circuit a screen saying 'Invalid circuit' will be displayed instead of the progress screen. Check that all the connections between the pieces of equipment are secure. You may need to return to the previous chapter of this manual to check that you have set up the system correctly.

### **SmartStop**

Turn the SmartStop function on or off. When SmartStop is on, the VPAP Adapt SV will automatically stop therapy when the mask is removed.

**Note:** *The unit will automatically 'SmartStart' whenever you start to breathe into the mask.*

### **Leak Alert**

If your clinician has enabled Leak Alert, you will hear an alert tone sound when you have a high leak from your mask. You can then adjust the mask on your face to remove the leak. If Leak Alert is turned off, an extra leak alert message will be displayed at the end of a session if high leak occurred. The message will be displayed until a key is pressed.

### **Ramp (CPAP mode only)**

Ramp time is the length of time taken for the air pressure to build up to the maximum pressure set by your clinician. This setting allows you to increase or decrease the ramp time in 5-minute intervals.

If you find that you are still awake when the air pressure starts to build you may wish to increase the Ramp time.

## **Results Menu**

This menu has a series of screens showing information about your most recent treatment session. If enabled by your clinician the following data may be viewed:

- Mask-fit
- Average Pressure
- Usage.

## Mask-fit

Gives a rating of how well the mask was fitting during your last session on the VPAP Adapt SV. The stars indicate how good the fit was (more stars = better fit).

Star rating	Definition
*****	Excellent
****_	Very good
***__	Good
**___	Adjust mask
*____	Adjust mask
HIGH LEAK	Adjust mask

## Average Pressure

Provides information on the average air pressure during your most recent session on the VPAP Adapt SV.

## Usage

Tells you how long the VPAP Adapt SV was in use during your most recent session.

## Options Menu

The Options menu allows you to change:

- Smart Data (Auto Appear)
- Backlight
- Language.

### Smart Data

If the SMART DATA - AUTO APPEAR option is set to ON, the screens available under the Results menu will be displayed automatically for approximately 20 minutes after your session is completed. After this time the data will still be available in the Results menu.

If you want to turn off AUTO APPEAR, select 'enter' in the SMART DATA screen by pressing the **Left** key. The AUTO APPEAR screen will be displayed. Select 'change' by pressing the **Left** key and you will switch from ON to OFF (similarly, you can turn it from OFF to ON). Your clinician may also turn off AUTO APPEAR.

### Backlight

On: Display a permanent backlight for the LCD.

Auto: Backlight turns off if no button has been pressed for two minutes.

### Language

Change the language of the LCD display. Languages available are: English, French, Spanish and Portuguese.

## Servicing Menu

This menu displays the following information:

- SN—the flow generator's serial number
- PCB—the flow generator's PCB number (PCB—printed circuit board)
- SW—the version of software currently installed on the flow generator.

## Treatment Screens

There are three Treatment screens displayed in the VPAP Adapt SV LCD. The LCD will display the Treatment screens when treatment commences, and during treatment if no key is pressed for 20 minutes.



Press the **QuickView** key at any point within a menu to display Treatment Screen 1. You can return to your original screen if you press the **QuickView** key again within 20 minutes.

Press the **Right** key to move from a Treatment screen to the Standby screen.

If an alarm is triggered while you are in the Treatment screens, the arrow will flash. Press the **Down** key until you reach the alarm message.

Scroll through the screens in the usual way, using the **Up/Down** key.

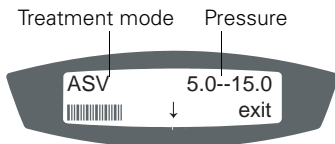

Figure 16: Treatment Screen 1

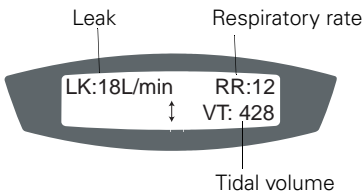

Figure 17: Treatment Screen 2

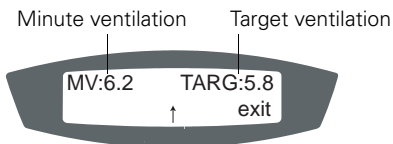

Figure 18: Treatment Screen 3

**Note:** TARG is not a relevant parameter in CPAP mode.



# Alarms

The VPAP Adapt SV unit is fitted with alarms to alert you to changes that will affect your treatment. The most common reason for an alarm to sound is because the system has not been properly assembled. Check that the air tubing and pressure sensor tube have been properly attached to the flow generator and mask (and humidifier if used).

You can mute an alarm by pressing the **Alarm Mute** key once. Unless the alarm requires you to turn the power off, you can press any key again to remove the alarm message from the LCD screen and to access all menus. If the problem is still present, the alarm will sound and display again after one minute. The Alarm LED will remain lit for as long as the problem is present.

We recommend that you test the audible alarm once a week. To do this, hold down the **Mute** key while the VPAP Adapt is starting up. If the alarm is functioning correctly it will beep twice.

LCD message	Alarm type	Action
LOW PRESSURE! Check circuit	Low mask pressure alarm	Check tube connections.
<i>LCD turns off</i>	Power fail alarm	Turn off VPAP Adapt SV at power switch.
HIGH PRESSURE! Turn power off	High pressure alarm	Turn off VPAP Adapt SV at power switch.
HIGH AVG PRESS!	High pressure alarm	Turn off VPAP Adapt SV at power switch.
HIGH LEAK! Check circuit	High mask leak alert	Adjust the mask.
LOW PS! Check circuit	Insufficient pressure Support alarm	Check tubing. Run LEARN CIRCUIT.
FLOW BLOCKED! Turn power off	Flow blocked alarm	Turn off VPAP Adapt SV. Check air circuit. Turn on VPAP Adapt SV.

## Low Mask Pressure Alarm

### Triggered by:

- pressure sensor line is blocked or disconnected
- air pressure at the mask has fallen below a set level
- mask is removed and SmartStop has been disabled.

### If a low pressure alarm sounds:

1. Check that the air tube and sensor tube are connected properly.
2. Turn the VPAP Adapt SV off and on again at the power switch. If the alarm persists, return the unit to ResMed for servicing.

**Will clear when:**

- the low pressure condition is fixed
- treatment is stopped by pressing the **Start/Stop** key.

## Power Fail Alarm

**Triggered by:**

- power failure
- machine is disconnected or switched off while delivering treatment.

**If a power fail alarm sounds:**

- the flow generator stops delivering air pressure.

**Will stop:**

- when the **Alarm Mute** key is pressed, or
- after two minutes, or
- when power is restored.

**CAUTION**

Remove the mask from your face if the power fails.

## High Pressure / High Average Pressure Alarms

**Triggered by:**

- **High Pressure Alarm:** the mask pressure exceeds the set trigger level (30 cm H<sub>2</sub>O) for more than 700 milliseconds.
- **High Average Pressure Alarm:** the mask pressure exceeds the set trigger level (22 cm H<sub>2</sub>O), averaged over approximately one minute.

**If a high pressure alarm sounds:**

1. The treatment will stop.
2. Turn power off.
3. Check that the air tube and sensor tube are connected properly.
4. Turn power back on.
5. Remove mask and perform Air Circuit Learn function.
6. Try using the flow generator one more time.
7. If the high pressure alarm activates repeatedly, discontinue use and return to ResMed for servicing. If the alarm does not recur, then continue to use as normal.

**Note:** The alarm system is designed to ignore coughing. However, if a cough is especially intense and prolonged, it may trigger the high pressure alarm.

**Will stop when:**

- the VPAP Adapt SV is turned off.

## High Leak Alert

### Triggered by:

- high mask leak (greater than 30 L/min) for more than 20 seconds
- the mask being removed while SmartStop is disabled.

### If a high leak alert sounds:

- adjust the mask to minimize leak
- check that the air tube and sensor tube are connected properly.

### Will stop when:

- the mask leak has been rectified.

**Note:** The High Leak alert can be turned off in the Leak Alert option in the Settings menu.

## Insufficient Pressure Support Alarm

### Triggered by:

- air pressure at the mask has failed to reach an expected level for 3 breaths
- the Air Circuit Learn function (page 21) has not been run after adding a new component (eg, new mask, humidifier) to the system.

### If an insufficient pressure support alarm sounds:

- check that the pressure sensor tubing is not kinked
- check that the pressure sensor tubing is properly connected
- run LEARN CIRCUIT.

### Will stop when:

- the pressure sensor tubing is unobstructed and properly connected to the flow generator and mask
- treatment is stopped (**Start/Stop** key or SmartStop)
- the VPAP Adapt SV is turned off.

## Flow Blocked Alarm

### Triggered by:

- blockage in air circuit.

### If a flow blocked alarm sounds:

1. The treatment will stop.
2. Turn power off.
3. Check whether there is a blockage in the air circuit.
4. Remove blockage.
5. Turn power back on.
6. If the flow blocked alarm activates repeatedly, discontinue use and return to ResMed for servicing. If the alarm does not recur, then continue to use as normal.

**Will stop when:**

- blockage is removed.

## Cleaning and Maintenance

You should regularly carry out the cleaning and maintenance described in this manual.

**CAUTION**

Do not wash the pressure sensor tube. If fluid enters the pressure sensor tube allow it to dry completely by hanging it in a clean place out of direct sunlight. If the pressure sensor tube cannot be dried completely it should be replaced.

### Daily

1. Disconnect the air tubing and pressure sensor tube and hang them in a clean, dry place until next use. Do not hang the air tubing in direct sunlight as it may harden and crack over time.
2. Clean the mask according to the mask user instructions.
3. If you are using a humidifier, clean it according to the instructions in the manual.

### Weekly

1. Remove the air tubing and pressure sensor tube from the VPAP Adapt unit and the mask.
2. Remove the pressure sensor tube and proximal cuff from the air tubing.
3. Wash the mask system according to the instructions supplied with it.
4. Wash the air tubing and proximal cuff in warm water using mild liquid soap. Rinse thoroughly, hang, and allow to dry.
5. Before next use, assemble the mask and headgear according to the mask user instructions.
6. Reconnect the pressure sensor tube to the air tubing, then connect both to the proximal cuff. Attach the proximal cuff to the mask.

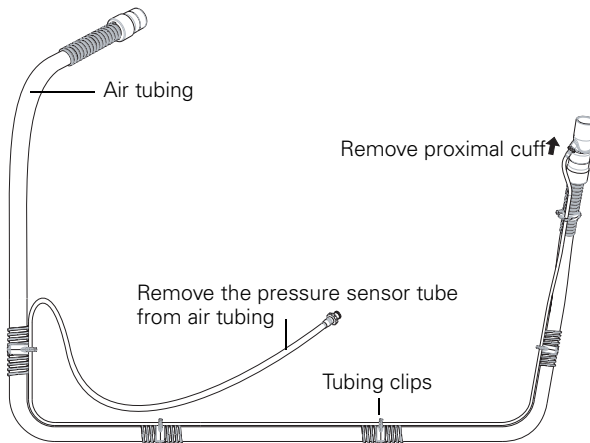

Figure 19: Air tubing assembly removed for cleaning



### CAUTION

- Do not use bleach, chlorine-, alcohol-, or aromatic-based solutions (including all scented oils), moisturising or antibacterial soaps to clean the cushion, mask, air tubing, or the VPAP Adapt SV. These solutions may cause hardening and reduce the life of the product.
- Do not wash or dry the mask frame at a temperature above 176°F (80°C). Exposure to higher temperatures may reduce the life of the product.
- Do not hang the air tubing and pressure sensor tube in direct sunlight as the tubing may harden over time and eventually crack.

## Periodically

1. The mask and air tubing are subject to normal wear and tear. Inspect them regularly for damage.
2. Remove the power cord. Clean the exterior of the flow generator with a damp cloth and mild liquid soap.
3. Inspect the air filter to check if it is blocked by dirt or contains holes. See full instructions below.



### WARNING

Beware of electric shock. Do not immerse the flow generator or power cord in water. Always unplug the flow generator before cleaning and be sure that it is dry before reconnecting.



### CAUTION

Do not attempt to open the VPAP Adapt SV. There are no user serviceable parts inside. Repairs and internal servicing should only be performed by an authorized service agent.

## Air Filter

Inspect the air filter every month and check if it is blocked by dirt or contains holes.

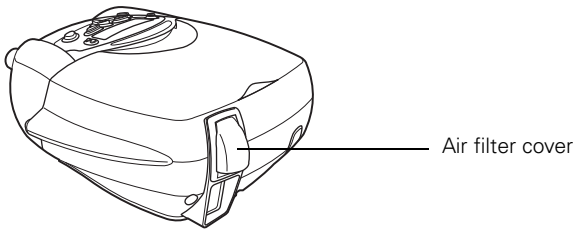

The filter should be replaced every six months, or more often if the flow generator is operating in a dusty environment.



### **WARNING**

Do not wash the air filter once it has become soiled. The air filter is not washable or reusable.

### **Fitting the filter**

- Remove the filter cover at the back of the flow generator.
- Remove and discard the old air filter.
- Insert a new filter, the blue tinted side facing towards you.

**Note:** Match the cut corner of the filter with the shape of the casing.

- Replace the air filter cover. The blue tinted side of the filter should be facing out.

## Hypoallergenic Air Filter

The ResMed hypo-allergenic filter is a standard filter to which an electrostatic filter has been bonded to capture very small particles. The filter is intended for those users of ResMed flow generators who will benefit from enhanced filtering of the air delivered during treatment.

Inspect the air filter every month and check if it is blocked by dirt or contains holes.

The filter should be replaced every three months, or more often if the flow generator is operating in a dusty environment.

Fit as described above in "Air Filter".

## Servicing

This product (VPAP Adapt SV) should be inspected by an authorised ResMed Service Centre five years from the date of manufacture. Prior to this, the device is intended to provide safe and reliable operation provided that it is operated and maintained in accordance with the instructions provided by ResMed.

Applicable ResMed warranty details are provided with the device at the time of original supply. Of course, as with all electrical devices, if any irregularity becomes apparent, you should exercise caution and have the device inspected by an authorized ResMed service center.

If you feel the unit is not performing properly, see “Troubleshooting” on page 31.

### **Servicing (Australia and New Zealand)**

This device is intended to provide safe and reliable operation when operated and maintained in accordance with the instructions provided by ResMed. To ensure that your device continues to provide optimum performance it is recommended that this product (VPAP Adapt SV) be inspected by an authorised ResMed Service Centre five years from the date of purchase.



### **CAUTION**

Inspection and repair should only be performed by an authorized service agent. Under no circumstances should you attempt to service or repair the unit yourself.

## Troubleshooting

If there is a problem, try the following suggestions. If the problem cannot be solved, contact your equipment supplier or ResMed. Do not attempt to open the flow generator.

Problem	Possible cause	Solution
<i>Insufficient air delivered from flow generator</i>	Air filter is dirty.	Replace air filter.
	Air tubing is kinked or punctured.	Straighten or replace tubing.
<i>Flow generator operating erratically, ie, switching on and off, pressure varying at random</i>	Water may have entered the air tubing.	Remove the water from the air tubing.
<i>Pressure rises inappropriately</i>	You are talking, coughing, voluntarily breath-holding (eg, while rolling over in bed), or intentionally breathing in an unusual manner.	Avoid talking with the mask on, and breathe as normally as possible.
	Severe mask leak or mouth leak (greater than 30 L/min).	Correct your leak condition.
<i>Alarm stays on continuously</i>	Blockage in air circuit.	Ensure there is no barrier to the passage of air.
	Internal malfunction.	Return the device to your equipment supplier for service.

Problem	Possible cause	Solution
<i>No LCD display</i>	Power not connected or switch at back is not on.	Ensure the power cable is connected, and that the switch at the back of the unit is in the 'on' position.
<i>FAULT message displayed on LCD</i>	Internal malfunction.	Return the device to your equipment supplier for service.
<i>System Error 7 message</i>	Device power-on has been interrupted by breathing into the mask during warm up.	Turn the flow generator off and on again. Do not place mask on face during warm up (30 seconds). Select LEARN CIRCUIT (page 21). If the error is not cleared, contact your equipment supplier for service.
	Internal malfunction.	Return the device to your equipment supplier for service.

## Glossary

### Alarms

When more than one alarm is activated at the one time, the highest priority alarm will be displayed.

### Backlight

The backlight turns off if no button has been pressed for two minutes. It can also be kept permanently on by selecting On in the Backlight screen of the Options menu.

### bpm

breaths per minute

### L/min

liters per minute

### Mean

The average value of the monitored parameter.

### Minute ventilation

A measure of the respiratory rate x tidal volume.

### Proximal cuff

A connector between the air tubing and the mask. The pressure sensor tubing attaches to the proximal cuff so that pressure at the mask can be detected and monitored.

### SmartStart

A feature that starts the VPAP Adapt SV automatically when you breathe into the mask.



**SmartStop**

A feature that stops the VPAP Adapt SV automatically when you remove the mask. You can turn SmartStop on or off in the Settings menu.

**Tidal volume**

The volume of air, in liters, breathed in or out in one breath.

## Technical Specifications

**Dimensions (H x W x D)**

5.6" x 9.8" x 11.5" (142 mm x 248 mm x 293 mm)

**Weight**

Flow generator with cover: 8.14 lbs (3.7 kg)

Flow generator with HumidAire 2i (empty): 9.24 lbs (4.2 kg)

**Environmental conditions**

Operating temperature: 41°F to 95°F (+5°C to +35°C)

Storage and transport temperature: -4°F to +140°F (-20°C to +60°C)

Humidity—operating, storage and transportation: 10%–95% non-condensing

**Housing construction**

Injection moulded plastic

**Air tubing**

1 x 6'6" (2 m)

**Air filter**

Synthetic fiber

**Patient connection port**

22 mm taper, compatible with ISO 5356-1:2004 Anaesthetic & Respiratory Equipment—Conical Connectors

**Power supply**

AC Input range: 110–120V and 220–240V; 50–60Hz; 60VA

DC Input range (if using DC Converter: 12–13.8V DC

**Performance**

Operating pressure range: 4–25 cm H<sub>2</sub>O

**Sound pressure level**

<30 dBA (tested in accordance with the requirements of ISO 17510-1)

**Battery type**

Lithium

## Alarm specifications

- **High maximum mask pressure alarm**

Stops air delivery at 30 cm H<sub>2</sub>O >700 msec.

- **High mean mask pressure alarm**

Stops air delivery when mean mask pressure exceeds 22 cm H<sub>2</sub>O (averaged over approx 1 minute).

- **Low mask pressure alarm**

Mask pressure is less than 3 cm H<sub>2</sub>O for longer than 5 seconds while the patient is using the VPAP Adapt SV.

- **Insufficient pressure support alarm**

Is triggered if for 3 breaths in a row the maximum mask pressure achieved at inspiratory to expiratory transition is either <87.5% of the absolute mask pressure targeted at that point, or < absolute mask pressure targeted minus 1 cm H<sub>2</sub>O, whichever is the lower.

- **High leak alarm**

Leak exceeds 30 L/min for more than 20 seconds.

- **Flow blocked alarm**

Flow is less than 6 L/min for more than 20 seconds.

## IEC 601-1 classifications

Class II, Type CF

Class II medical electrical equipment provides protection against electric shock either by double insulation or reinforced insulation and does not require a protective earth.

### Inspiratory Trigger Characteristics

The inspiratory trigger occurs at a flow greater than 0 LPM when tested with EPAP=5 cm H<sub>2</sub>O, IPAP=15 cm H<sub>2</sub>O, sinusoidal breath shape. The inspiratory trigger response time is <600 ms when tested with EPAP=5 cm H<sub>2</sub>O, IPAP=15 cm H<sub>2</sub>O, 0.67 L/sec inspiratory and expiratory flow rate. The time is measured from the beginning of inspiratory flow to the beginning of pressure rise to IPAP.

**Note:** *The ASV algorithm is designed to treat a patient with essentially normal lungs. Hence, trigger response is less sensitive and pressure ramp-up is more gentle than typical non-invasive ventilators.*

## Displayed values

Value	Range	Accuracy	Display Resolution
<b>Proximal cuff</b>			
Pressure	-3 to 40 cm H <sub>2</sub> O	0.5 cm H <sub>2</sub> O	0.1 cm H <sub>2</sub> O
<b>Mass flow sensor</b>			
Leak	0–99 liters per minute	+/- 12 L/min	1 liter per breath
Respiratory rate	8–30 breaths per minute	+/- 10%	1 breath per minute
Tidal volume	0–4500 milliliters	+/- 10%	1 milliliter
Minute ventilation	0–40 liters per minute	+/- 10%	0.1 liters per minute
Target MV	0–40 liters per minute	+/- 10%	0.1 liters per minute

## Maximum low impedance flow at stated pressures

Pressure (cm H <sub>2</sub> O)	Flow (L/min)
4.2	217
8.6	218
13.0	219



### Glossary of symbols

Read the relevant operating manual before using



Type CF equipment



AC switch



Class II



Drip proof

IPX1

## Guidance and Manufacturer's Declaration – Electromagnetic Emissions and Immunity

### Guidance and manufacturer's declaration – electromagnetic emissions

The VPAP Adapt SV is intended for use in the electromagnetic environment specified below. The customer or the user of the VPAP Adapt SV should assure that it is used in such an environment.

Emissions test	Compliance	Electromagnetic environment - guidance
RF emissions CISPR 11	Group 1	The VPAP Adapt SV uses RF energy only for its internal function. Therefore, its RF emissions are very low and are not likely to cause any interference in nearby electronic equipment.
RF emissions CISPR 11	Class B	The VPAP Adapt SV is suitable for use in all establishments, including domestic establishments and those directly connected to the public low-voltage network that supplies buildings used for domestic purposes.
Harmonic Emissions IEC 61000-3-2	Class A	
Voltage Fluctuations/Flicker Emissions IEC 61000-3-3	Complies	

Medical Electrical Equipment needs special precautions regarding EMC and needs to be installed and put into service according to EMC information provided in this document.

**Warnings:** The VPAP Adapt SV should not be used adjacent to or stacked with other equipment. If adjacent or stacked use is necessary, the VPAP Adapt SV should be observed to verify normal operation in the configuration in which it will be used.

The use of accessories (eg Humidifiers) other than those specified in this manual is not recommended. They may result in increased emissions or immunity of the VPAP Adapt SV.

## Guidance and manufacturer's declaration – electromagnetic immunity

The VPAP Adapt SV is intended for use in the electromagnetic environment specified below. The customer or the user of the VPAP Adapt SV should assure that it is used in such an environment.

Immunity test	IEC60601-1-2 test level	Compliance level	Electromagnetic environment – guidance
Electrostatic discharge (ESD) IEC 61000-4-2	±6 kV contact ±8 kV air	±6 kV contact ±8 kV air	Floors should be wood, concrete or ceramic tile. If floors are covered with synthetic material, the relative humidity should be at least 30%.
Electrical fast transient/burst IEC 61000-4-4	±2 kV for power supply lines ±1 kV for input/output lines	±2 kV Not Applicable	Mains power quality should be that of a typical commercial or hospital environment.
Surge IEC 61000-4-5	±1 kV differential mode ±2 kV common mode	±1 kV differential mode ±2 kV common mode	Mains power quality should be that of a typical commercial or hospital environment.
Voltage dips, short interruptions and voltage variations on power supply input lines. IEC 61000-4-11	<5% $U_t$ (>95% dip in $U_t$ ) for 0.5 cycle  40% $U_t$ (60% dip in $U_t$ ) for 5 cycles  70% $U_t$ (30% dip in $U_t$ ) for 25 cycles  <5% $U_t$ (>95% dip in $U_t$ ) for 5 sec	< 12V (>95% dip in 240V) for 0.5 cycle  96V (60% dip in 240V) for 5 cycles  168V (30% dip in 240V) for 25 cycles  <12V (>95% dip in 240V) for 5 sec	Mains power quality should be that of a typical commercial or hospital environment. If the user of the VPAP Adapt SV requires continued operation during power mains interruptions, it is recommended that the VPAP Adapt SV be powered from an uninterruptible power source.
Power frequency (50/60 Hz) magnetic field IEC 61000-4-8	3 A/m	3 A/m	Power frequency magnetic fields should be at levels characteristic of a typical location in a typical commercial or hospital environment

NOTE:  $U_t$  is the AC mains voltage prior to application of the test level.

(Continued next page)

## Guidance and manufacturer's declaration – electromagnetic immunity (continued)

The VPAP Adapt SV is intended for use in the electromagnetic environment specified below. The customer or the user of the VPAP Adapt SV should assure that it is used in such an environment.

Immunity test	IEC60601-1-2 test level	Compliance level	Electromagnetic environment – guidance
Conducted RF IEC 61000-4-6	3 Vrms 150 kHz to 80 MHz	3 Vrms	Portable and mobile RF communications equipment should be used no closer to any part of the VPAP Adapt SV, including cables, than the recommended separation distance calculated from the equation applicable to the frequency of the transmitter.  Recommended separation distance $d = 1.17 \sqrt{P}$
Radiated RF IEC 61000-4-3	10 V/m 80 MHz to 2.5 GHz	10 V/m	$d = 0.35 \sqrt{P}$ 80 MHz to 800 MHz  $d = 0.70 \sqrt{P}$ 800 MHz to 2.5 GHz  where P is the maximum output power rating of the transmitter in watts (W) according to the transmitter manufacturer and d is the recommended separation distance in meters (m). Field strengths from fixed RF transmitters, as determined by an electromagnetic site survey, <sup>a</sup> should be less than the compliance level in each frequency range. <sup>b</sup> Interference may occur in the vicinity of equipment marked with the following symbol:  

NOTE 1: At 80 MHz and 800 MHz, the higher frequency range applies.

NOTE 2: These guidelines may not apply in all situations. Electromagnetic propagation is affected by absorption and reflection from structures, objects and people.

<sup>a</sup> Field strengths from fixed transmitters, such as base stations for radio (cellular/cordless) telephones and land mobile radios, amateur radio, AM and FM radio broadcast and TV broadcast cannot be predicted theoretically with accuracy. To assess the electromagnetic environment due to fixed RF transmitters, an electromagnetic site survey should be considered. If the measured field strength in the location in which the VPAP Adapt SV is used exceeds the applicable RF compliance level above, the VPAP Adapt SV should be observed to verify normal operation. If abnormal performance is observed, additional measures may be necessary, such as reorienting or relocating the VPAP Adapt SV.

<sup>b</sup> Over the frequency range 150 kHz to 80 MHz, field strengths should be less than 10 V/m.

## Recommended separation distances between portable and mobile RF communications equipment and the VPAP Adapt SV

The VPAP Adapt SV is intended for use in an environment in which radiated RF disturbances are controlled. The customer or the user of the VPAP Adapt SV can help prevent electromagnetic interference by maintaining a minimum distance between portable and mobile RF communications equipment (transmitters) and the VPAP Adapt SV as recommended below, according to the maximum output power of the communications equipment.

	Separation distance according to frequency of transmitter m		
	150 kHz to 80 MHz $d = 1.17 \sqrt{P}$	80 MHz to 800 MHz $d = 0.35 \sqrt{P}$	800 MHz to 2.5 GHz $d = 0.7 \sqrt{P}$
Rated maximum output power of transmitter W			
0.01	0.17	0.04	0.07
0.1	0.37	0.11	0.22
1	1.17	0.35	0.70
10	3.69	1.11	2.21
100	11.70	3.50	7.00

For transmitters rated at a maximum output power not listed above, the recommended separation distance  $d$  in metres (m) can be determined using the equation applicable to the frequency of the transmitter, where  $P$  is the maximum output power rating of the transmitter in watts (W) according to the transmitter manufacturer.

NOTE 1: At 80 MHz and 800 MHz, the separation distance for the higher frequency range applies.

NOTE 2: These guidelines may not apply in all situations. Electromagnetic propagation is affected by absorption and reflection from structures, objects and people.

# Limited Warranty

ResMed warrants that your ResMed product shall be free from defects in material and workmanship for the period specified below from the date of purchase by the initial consumer. This warranty is not transferable.

Product	Warranty Period
ResMed humidifiers, ResControl™, ResLink™, ResTraxx™	1 Year
ResMed flow generators	2 Years
Accessories, mask systems (including mask frame, cushion, headgear and tubing). Excludes single-use devices.	90 Days

**Note:** *Some models are not available in all regions.*

If the product fails under conditions of normal use, ResMed will repair or replace, at its option, the defective product or any of its components. This Limited Warranty does not cover:

- a) any damage caused as a result of improper use, abuse, modification or alteration of the product;
- b) repairs carried out by any service organization that has not been expressly authorized by ResMed to perform such repairs;
- c) any damage or contamination due to cigarette, pipe, cigar or other smoke;
- d) any damage caused by water being spilled on or into a flow generator.

Warranty is void on product sold, or resold, outside the region of original purchase. Warranty claims on defective product must be made by the initial consumer at the point of purchase.

This warranty is in lieu of all other express or implied warranties, including any implied warranty of merchantability or fitness for a particular purpose. Some regions or states do not allow limitations on how long an implied warranty lasts, so the above limitation may not apply to you.

ResMed shall not be responsible for any incidental or consequential damages claimed to have occurred as a result of the sale, installation or use of any ResMed product. Some regions or states do not allow the exclusion or limitation of incidental or consequential damages, so the above limitation may not apply to you. This warranty gives you specific legal rights, and you may also have other rights which vary from region to region.

For further information on your warranty rights, contact your local ResMed dealer or ResMed office.

R001-307/2 05 06



# Index

## A

- air circuit learn function 21
- air filter 30
  - hypoallergenic 30
- air pressure
  - monitoring 23
- air tubing
  - attaching to mask 9
  - cleaning 28
  - connecting 9
- air tubing system 6, 7, 9
- alarm
  - flow blocked 27
  - high leak 27
  - high pressure 26
  - low mask pressure 25
  - power fail 26
- alarm LED 18
- anti-bacterial filter 14

## B

- backlight
  - change setting 23

## C

- cautions 4
- contraindications 3
- CPAP mode 21

## D

- DC converter 15

## F

- fault message 31

## H

- HumidAire
  - connection 12
- HumidAire 2i 11
- humidifier
  - connecting 10
  - types 10

## K

- key
  - alarm mute 18, 25
  - left 18

- right 18
- start/stop 17
- up/down 17

## L

- language
  - change setting 23
- LCD display 31
- leak alert 22
- learn circuit 21
- Luer connector 9

## M

- mask
  - connection 9
  - indication of fit 23
  - recommended 7
  - select from menu 21
- medical information 3
- menus
  - how to use 19
  - navigation 20

## O

- Options menu 23
- oxygen
  - supplemental 15

## P

- power cord
  - connection 8
- pressure sensor tube
  - connecting 9
- proximal cuff 7

## Q

- quick setup guide 5

## R

- Ramp 21, 22
- ResLink 14
- Results menu 22

## S

- Settings menu 20
- Smart data 23
- SmartStop 22

standby mode 16  
starting treatment 16  
stopping treatment 16  
Supplemental oxygen 15  
System Error 7 message 32

## **T**

Treatment screens 24

## **U**

user/owner responsibility 3

## **V**

VPAP Adapt SV

usage 23

VPAP Adapt SV Components 6

## Free Manuals Download Website

<http://myh66.com>

<http://usermanuals.us>

<http://www.somanuals.com>

<http://www.4manuals.cc>

<http://www.manual-lib.com>

<http://www.404manual.com>

<http://www.luxmanual.com>

<http://aubethermostatmanual.com>

Golf course search by state

<http://golfingnear.com>

Email search by domain

<http://emailbydomain.com>

Auto manuals search

<http://auto.somanuals.com>

TV manuals search

<http://tv.somanuals.com>